



# The 35mm SLR Photo

SourceBook



\$6.95

420 Ninth Ave., New York, NY 10001

Toll Free

800 290-6750

Fax:  
800.947.7008

In New York:

212 502-6340

Fax:  
212.239.7770

[www.bhphotovideo.com](http://www.bhphotovideo.com)



# The 35mm SLR Photo

SourceBook

# SourceBook

## Table of Contents

|                             |         |
|-----------------------------|---------|
| 35mm SLR Cameras .....      | 6-193   |
| Underwater Equipment.....   | 194-213 |
| Flashes and Meters.....     | 214-319 |
| Filters.....                | 320-421 |
| Tripods & Accessories ..... | 422-523 |
| Bags & Carts .....          | 524-623 |
| Copy Stands .....           | 624-635 |
| General Accessories.....    | 635-643 |
| Library (Books) .....       | 644-685 |
| Index.....                  | 686     |







# The 35mm SLR Photo

SourceBook

## Section 1

### 35mm SLR and Rangefinder Cameras

|                      |         |
|----------------------|---------|
| Beattie .....        | 8-9     |
| Canon .....          | 10-47   |
| Hasselblad.....      | 48-50   |
| Noblex.....          | 51      |
| Kenko .....          | 52-53   |
| Leica.....           | 54-75   |
| Konica Minolta ..... | 76-93   |
| Nikon .....          | 94-137  |
| Pentax .....         | 138-151 |
| Phoenix.....         | 152-155 |
| Sigma .....          | 156-170 |
| Rollei .....         | 171     |
| Tamron.....          | 172-177 |
| Tokina .....         | 178-181 |
| Vivitar .....        | 182-185 |
| Voigtlander .....    | 186-193 |



# BEATTIE

## INTENSCREEN

Low available light can be one of the most frustrating conditions in which photographers are forced to work. The lack of contrast and image definition make it difficult, if not impossible, to bring your subject into sharp focus. Heavy shadows, dimly lit rooms and evening shooting schedules often result in soft images, not to mention tired and sore eyes. Beattie Intenscreen bright focusing screens help eliminate these problems making it easier to get the perfect shot. Beattie Intenscreens are available for hundreds of the most popular 35mm cameras with variations, including grid patterns and split image focus available within each camera model.

In addition, many sports, nature and astro-photographers use 35mm cameras because the wide selection of telephoto lenses make it easy to get close to the subject. However, longer telephoto lenses, particularly zoom lenses, often have a smaller maximum aperture making them slow and difficult to focus in low light. A Beattie Intenscreen bright focusing screen will increase image brightness by 1 to 1½ stops, making it easier to focus on distant subject, even when using a telephoto lens.

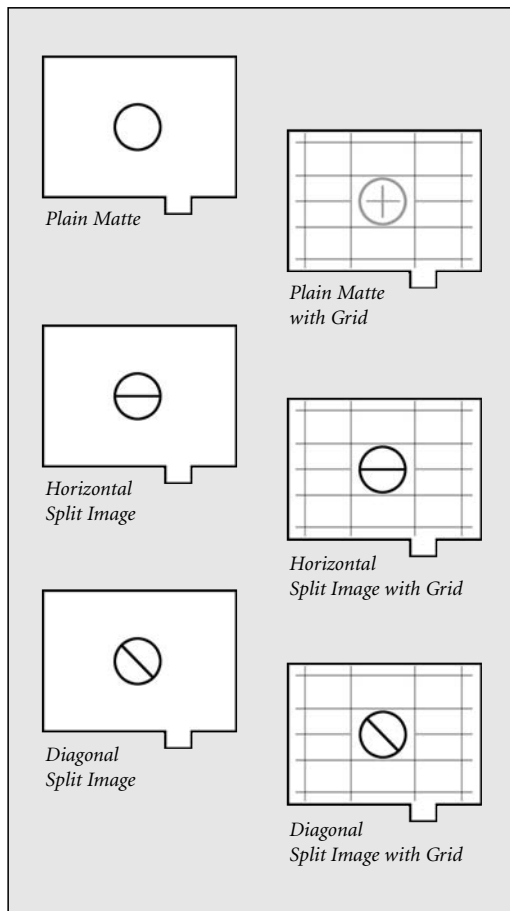

### Screen Variations

To accommodate the diverse needs of the photographer, there are several varieties of Beattie Intenscreen available within each camera product category. Most 35mm Beattie focusing screens are available with either a plain matte focusing surface or with split image focusing.

Plain focusing screens, which are similar in appearance to traditional ground glass screens, offer an unobstructed viewing image and are ideal for outdoor and landscape photography.

Split image focusing screens, situated either horizontally or diagonally, provide centrally located focus assistance and are a good choice for wedding and portrait photographers.

In most cases, both plain and split image screens are available with an optional grid pattern for architectural and other precision photography. The drawings illustrate the six varieties typically offered for most 35mm focusing screens. Not all styles are available for each camera model.

#### For Canon EOS A2 / A2E

- Plain Matte (BEFSCEA2).....**92.95**
- Matte with Grid (BEFSGCA2) .....**92.95**

#### For Canon EOS-1, 1N, 1v and 3

- Plain Matte (BEFSCE1) .....**104.95**
- Matte with Grid (BEFSGCE1).....**104.95**
- Matte with Horizontal Split Image (BEFSSIHCE1).....**104.95**
- Matte with Grid and Horizontal Split Image (BEFSSIHGCE1) .....**104.95**

#### For Contax RTS II

- Plain Matte (BEFSCRTS2).....**92.95**
- Matte with Grid (BEFSGCRTS2).....**92.95**
- Matte with Grid and Horizontal Split Image (BEFSSIHGCRS2).....**92.95**
- Matte with Diagonal Split Image (BEFSSIDCRS2).....**92.95**

#### For Contax RTS III

- Plain Matte (BEFSCRTS3).....**92.95**
- Matte with Grid (BEFSGCRTS3).....**92.95**

# BEATTIE

## INTENSCREEN

CAMERAS & LENSES

9

### For Leica R4 / R5 / R6 / 6.2 / 7

|   |       |
|---|-------|
| Plain Matte (BEFSLR4) .....               | 92.95 |
| Matte with Grid (BEFSGLR4) .....          | 92.95 |
| Matte with                                |       |
| Horizontal Split Image (BEFSSHLR4) .....  | 92.95 |
| Matte with Grid and                       |       |
| Horizontal Split Image (BEFSSHGLR4) ..... | 92.95 |
| Matte with                                |       |
| Diagonal Split Image (BEFSSIDL4) .....    | 92.95 |
| Matte with Grid and                       |       |
| Diagonal Split Image (BEFSSIDGL4) .....   | 92.95 |

### For Nikon FA / FE / FE2 / FM2

|   |       |
|---|-------|
| Plain Matte (BEFSNFE2) .....                | 92.95 |
| Matte with Grid and                         |       |
| Horizontal Split Image (BEFSSIHGNFE2) ..... | 92.95 |
| Matte with Horizontal                       |       |
| Split Image (BEFSSIHNFE2) .....             | 92.95 |
| Matte with Grid (BEFSGNFE2) .....           | 92.95 |
| Matte with Diagonal                         |       |
| Split Image (BEFSSIDNFE2) .....             | 92.95 |
| Matte with Grid and                         |       |
| Diagonal Split Image (BEFSSIDGNFE2) .....   | 92.95 |

### For Nikon 8008 and 801 Series

|   |       |
|---|-------|
| Matte with Grid (BEFSGN8008) .....        | 92.95 |
| Plain Matte (BEFSN8008) .....             | 92.95 |
| Matte with Horizontal                     |       |
| Split Image (BEFSSIHN8008) .....          | 92.95 |
| Matte with Grid and Horizontal            |       |
| Split Image (BEFSSIHGN800) .....          | 92.95 |
| Matte with                                |       |
| Diagonal Split Image (BEFSSIDN8008) ..... | 92.95 |
| Matte with Grid and                       |       |
| Diagonal Split Image (BEFSSIDGN800) ..... | 92.95 |

### For Nikon N90 / N90s

|   |       |
|---|-------|
| Plain Matte (BEFSNN90) .....              | 92.95 |
| Matte with Grid (BEFSGNN90) .....         | 92.95 |
| Matte with Horizontal                     |       |
| Split Image (BEFSSIHNN90) .....           | 92.95 |
| Matte with Grid and Horizontal            |       |
| Split Image (BEFSSIHGNN90) .....          | 92.95 |
| Matte with                                |       |
| Diagonal Split Image (BEFSSIDNN90) .....  | 92.95 |
| Matte with Grid and                       |       |
| Diagonal Split Image (BEFSSIDGNN90) ..... | 92.95 |

### For Nikon F100

|                                    |       |
|------------------------------------|-------|
| Plain Matte (BEFSNF100) .....      | 89.95 |
| Matte with Grid (BEFSGNF100) ..... | 89.95 |
| Matte with Horizontal              |       |
| Split Image (BEFSSIHNF100) .....   | 89.95 |
| Matte with Grid and Horizontal     |       |
| Split Image (BEFSSIHGNF10) .....   | 89.95 |
| Matte with Diagonal                |       |
| Split Image (BEFSSIDNF100) .....   | 89.95 |
| Matte with Grid and Diagonal       |       |
| Split Image (BEFSSIDGNF10) .....   | 89.95 |

### For Nikon F5

|                                  |        |
|----------------------------------|--------|
| Matte with Grid (BEFSGNF5) ..... | 124.95 |
| Plain Matte (BEFSNF5) .....      | 124.95 |
| Matte with Horizontal            |        |
| Split Image (BEFSSIHNF5) .....   | 124.95 |
| Matte with Diagonal              |        |
| Split Image (BEFSSIDNF5) .....   | 124.95 |
| Matte with Grid and Horizontal   |        |
| Split Image (BEFSSIHGNF5) .....  | 124.95 |
| Matte with Grid and Diagonal     |        |
| Split Image (BEFSSIDGNF5) .....  | 124.95 |

### For Nikon F and F2 Cameras

|   |        |
|---|--------|
| Plain Matte (BEFSNF2) .....               | 114.95 |
| Matte with Grid (BEFSGNF2) .....          | 114.95 |
| Split Image Horizontal (BEFSSIHNF2) ..... | 114.95 |
| Matte with Grid and Horizontal            |        |
| Split Image (BEFSSIHGNF2) .....           | 114.95 |
| Matte with Diagonal                       |        |
| Split Image (BEFSSIDNF2) .....            | 114.95 |
| Matte with Grid and Diagonal              |        |
| Split Image (BEFSSIDGNF2) .....           | 114.95 |

### For Nikon F3

|                                  |        |
|----------------------------------|--------|
| Plain Matte (BEFSNF3) .....      | 114.95 |
| Matte with Grid (BEFSGNF3) ..... | 114.95 |
| Matte with Horizontal            |        |
| Split Image (BEFSSIHNF3) .....   | 114.95 |
| Matte with Grid and Horizontal   |        |
| Split Image (BEFSSIHGNF3) .....  | 114.95 |
| Matte with Diagonal              |        |
| Split Image (BEFSSIDNF3) .....   | 114.95 |
| Matte with Grid and Diagonal     |        |
| Split Image (BEFSSIDGNF3) .....  | 124.95 |

### For Nikon F4 Series

|                                  |        |
|----------------------------------|--------|
| Plain Matte (BEFSNF4) .....      | 124.95 |
| Matte with Grid (BEFSGNF4) ..... | 124.95 |
| Matte with Horizontal            |        |
| Split Image (BEFSSIHNF4) .....   | 124.95 |
| Matte with Grid and Horizontal   |        |
| Split Image (BEFSSIHGNF4) .....  | 124.95 |

### For Olympus OM-Series

|   |       |
|---|-------|
| Matte with Grid (BEFSGOM1) .....        | 92.95 |
| Plain Matte (BEFSOM1) .....             | 92.95 |
| Matte with Horizontal                   |       |
| Split Image (BEFSSIHOM1) .....          | 92.95 |
| Matte with Grid and Horizontal          |       |
| Split Image (BEFSSIHGOM1) .....         | 92.95 |
| Matte with                              |       |
| Diagonal Split Image (BEFSSIDOM1) ..... | 92.95 |
| Matte with Grid and Diagonal            |       |
| Split Image (BEFSSIDGOM1) .....         | 92.95 |

### For Pentax LX

|                                  |       |
|----------------------------------|-------|
| Matte with Grid (BEFSGPLX) ..... | 92.95 |
| Plain Matte (BEFSPLX) .....      | 92.95 |
| Matte with Horizontal            |       |
| Split Image (BEFSSIHPLX) .....   | 92.95 |
| Matte with Grid and Horizontal   |       |
| Split Image (BEFSSIHGPLX) .....  | 92.95 |
| Matte with Diagonal              |       |
| Split Image (BEFSSIDPLX) .....   | 92.95 |
| Matte with Grid and Diagonal     |       |
| Split Image (BEFSSIDGPLX) .....  | 92.95 |

### For Pentax PZ-1

|                                   |       |
|-----------------------------------|-------|
| Plain Matte (BEFSPPZ1) .....      | 92.95 |
| Matte with Grid (BEFSGPPZ1) ..... | 92.95 |
| Matte with Horizontal             |       |
| Split Image (BEFSSIHPPZ1) .....   | 92.95 |
| Matte with Grid and Horizontal    |       |
| Split Image (BEFSSIHGPPZ1) .....  | 92.95 |
| Matte with Diagonal               |       |
| Split Image (BEFSSIDPPZ1) .....   | 92.95 |
| Matte with Grid and Diagonal      |       |
| Split Image (BEFSSIDGPPZ1) .....  | 92.95 |

ORDER & INFO. (212) 502-6340 • FAX: (212) 239-7770 (800) 947-7008  
1-800-290-6750 • www.bhphotovideo.com





# CANON

## EOS REBEL SERIES

CAMERAS & LENSES

10

### **Rebel GII—SLR Simplicity and Elegance**

Want to step-up from a less versatile point-and-shoot camera? The affordable Rebel GII offers the budget-minded a slew of advanced features and functionality that make it ideal for students or anybody else who want greater creative control when taking photographs. Although compact and extremely lightweight (body weighs only 12 oz.), the Rebel GII incorporates some of the most advanced features available in an entry-level SLR camera including 11 exposure modes, 3-point autofocus system, Auto Exposure Bracketing (AEB), manual focusing point selection in the viewfinder and settings for multiple exposures and other creative effects. Additional features include a Night Scene mode which combines the perfect balance between natural light and flash for stunning portraits, a bright viewfinder, metered manual for creative exposure flexibility, AE Lock, a retractable flash with red-eye reduction and a beeper for focus confirmation. It is fully compatible with the complete line of Canon EF lenses, as well as a wide variety of EOS system accessories including a remote controller, a battery grip, close-up accessories and a comprehensive line-up of EX-Series Speedlites, featuring the versatile E-TTL flash exposure metering system.



### **Rebel K2—SLR Excitement and Performance**

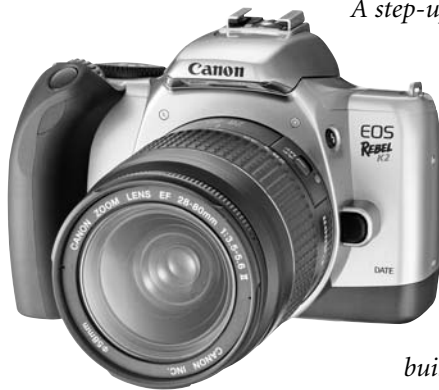

A step-up from (and a step quicker than) than the entry level EOS Rebel GII, the Rebel K2 features Canon's premier 7-point wide area AF system and 35-zone AF-linked evaluative metering that optimizes exposure accuracy. Fast autofocus and film advance permit you to shoot at 1.5 frames per second, 50 percent faster than the GII. Tracking and keeping moving subjects in focus is a breeze thanks to the Rebel K2's AI Servo AF mode and seven point selectable autofocus system. Users can also opt for manual focusing point selection by simply pressing the Focusing Point Selector and rotating the main dial until the preferred focus point is indicated below the picture area in the viewfinder data display, or on the large, easy-to-read LCD data panel on the back of the camera. In the Full Auto and Programmed Image Control modes, the built-in flash pops up and fires automatically in low-light or backlit situations.

### **Rebel T2—The Next Generation SLR**

The Rebel T2 steps up with a stainless steel lens mount fully compatible with all EF-series lenses; an AF tracking speed rivaling Canon's professional Elan and EOS-3 cameras; and up to 3 frames-per-second film advance. It boasts a maximum shutter speed of 1/4000 second and X-sync at 1/125 sec. It also offers E-TTL II autoflash metering for both the built-in flash and external EX-series Speedlites, a shutter lock that prevents shooting if there is no film in the camera, and an anti-shake warning if the shutter speed is too low for hand-held photography according to the focal length of the lens. Finally, the Rebel T2 features user-selectable custom functions that let you tailor specific camera features according to personal preferences.



For Any Inquiries Regarding Your Order, Call Our Customer Service:  
(800) 221-5743 • (212) 239-7765 • FAX: (800) 947-2215 • (212) 239-7549

# CANON

## EOS REBEL SERIES

### High Performance AF

With the Rebel series, the focus is on speed, accuracy, and flexibility! 7-focusing points (3 points for the GII) cover a wider area. Each can detect whether the subject is moving or still, and instantly adjusts autofocus to match. There are no surprises with off-center subjects or areas with multiple focusing points, as all selected points are clearly and brightly highlighted in the viewfinder.

- One-Shot AF lets you lock in autofocus on the subject. You can then relax and reframe if necessary.
- Predictive AI Servo AF mode lets you shoot moving subjects with confidence, knowing you can count on sharp focus. When a subject's movement is detected, the cameras track it and calculate the correct exposure with a high degree of precision.
- Advanced AI Focus AF system enable them to automatically switch from One-Shot AF to AI Servo AF when they detect a subject in motion (in Creative Image mode).
- **The T2 lets you select AF modes independently. A four-position keypad on the back of the camera also makes autofocus point selection more intuitive and faster.**

### Creative Controls

- ◆ Want to recompose a picture after fixing focus. Or want to determine exposure separately from focus. AE Lock is the answer. By pressing the AE Lock button, the exposure is precisely set and stored in memory. This lets you achieve superb exposure control even in difficult lighting situations.
- ◆ Multiple Exposure Control lets you place up to 9 images in a single frame to create special effect images, capture progressive motion, or produce surrealistic creative compositions.
- ◆ Auto Exposure Bracketing automatically shoots three consecutive exposures—one underexposed, one overexposed and one correct—in a customizable range of 0 to  $\pm 2$  stops in 1/2-stop increments.
- ◆ **The T2 features custom functions allowing you to tailor the camera to your preference. These include adjustable self-timer (2- or 10-seconds), emit built-in AF assist beam (on/off), shutter speed curtain with built-in flash and external Speedlites and flash sync in AV mode.**

### Shooting Modes

*The Command Dial makes selecting any exposure mode fast and effortless. You can use the dial to set either Creative Image Control Modes or Programmed Image Control Modes. This allows even novice photographers to handle a full range of shooting situations quickly and confidently.*

#### Programmed Image Control Modes

Canon's Programmed Image Control Modes automatically deliver the optimum aperture, shutter speed and other functions for typical shooting environments. Designed primarily for beginners, they optimize results in popular applications such as portraits, landscapes, close-ups, sports, and night scenes. Simply select the mode from the Command Dial that fits the scene and Rebel handles the rest.

**Portrait:** By setting a larger aperture, this mode keeps the foreground in sharp focus while artistically blurring the background to create a dramatic portrait.

**Landscape:** By stopping down the lens, this mode produces the precise depth-of-field that keeps everything in the scene sharp and crisply focused.

**Night Scene:** By the reducing the shutter speed and firing the flash, this mode produces "after dark" shots with brightly lit subjects and softly glowing backgrounds.

**Close-up:** In Close-up, partial metering is engaged to make the primary subject "pop out" against the background.

**Sports:** A faster shutter speed and predictive AI Servo to AF freezes motion to give you impressive action shots with ease.

**Full Auto:** Never worry again about missing a shot. Simply frame the subject and press the shutter button. The Rebel automatically meters the scene, sets the right combination of aperture and shutter speed and even fires a flash, when needed.

All three Rebel models have a built-in motor winder for fast, silent continuous film advance. They differ only in speed: One frame per second (fps) on the Rebel GII, up to 1.5 fps on the Rebel K2, and up to 3 fps on the Rebel T2.

#### Creative Image Control Modes

Canon's Creative Image Control Modes automatically deliver the optimum aperture, shutter speed and other functions when you are ready to be more creative. Simply select the mode from the Command Dial that fits the scene and Rebel handles the rest.

**Auto Depth-of-Field AE (A-DEP):** This setting automatically chooses an aperture and focus point that brings the entire scene into razor-sharp focus—from foreground to background. (The T2 also includes a dedicated depth-of-field preview button that allows you to see exactly what you have in focus before you take your shot.)

**Intelligent Program AE (P):** In this mode, the camera sets the optimal combination of aperture and shutter speed based on the focal length in use. With a turn of the Main Dial, you can use different speed/aperture values for greater creative control while keeping the same exposure level.

**Shutter Priority AE:** Set the shutter speed (up to 1/2000 sec. or 1/4000 on the T2) and the cameras will set the correct aperture. Startling effects like freezing action or creating a creative blur are simple to achieve.

**Aperture Priority AE:** You set the aperture and they automatically choose the correct shutter speed.

**Manual Control:** In this mode you have complete creative control over both shutter speed and aperture settings. Any combination of shutter speed and aperture can be set. There is also the option of activating or overriding the Rebel's exposure metering systems.



# CANON

## EOS REBEL SERIES

### Rebel K2/T2 Only

- ◆ Their controls have been designed to allow true single-handed shooting. Shutter release, AE Lock button, AF Point Selector, Command Dial and Main dial are all in easy reach of the hand that holds the grip.
- ◆ Arm incorporated into their pop-up flash mechanism increases the distance between the optical axis and the center of the built-in flash. This further reduces the chance of red-eye or partial obstruction from the attached lens.
- ◆ An optional AA battery pack (BP-220) is available to them. Attaching neatly to their base, the pack provides an ergonomic vertical grip with a shutter button.

### Rebel T2 Only

- ◆ Features E-TTL II autoflash metering for both the built-in flash and external EX-series Speedlites (see Elan 7N for details)
- ◆ For high speed operation, the T2 features up to 3 frames per second film advance, high-speed shutter of up to 1/4000 second and X-sync at 1/125 sec.
- ◆ Dioptic adjustment from -2.5 to +0.5 allows photographers who wear glasses the freedom to shoot with or without them.
- ◆ Dedicated depth-of-field preview button allows you to see exactly what you have in focus before you take your shot.
- ◆ Orientation Detection Sensor automatically recognizes whether a shot is vertical or horizontal. Then, the camera's metering systems reads the brightness of the sky or earth separately.
- ◆ Outfitted in a dark metallic gray finish, the T2's compactness is emphasized with cut-away surfaces on the front and back of the top cover. A black rubber skin on the grip, offers additional holding comfort. Large, illuminated LCD data panel and oversized command dial allow single-handed adjustment of all camera controls. For rugged durability, the Rebel T2 is outfitted with a high-quality stainless steel lens mount.
- ◆ For convenience a shutter lock prevents shooting if there is no film in the camera, and an anti-shake warning, which can be turned on/off prevents the user from taking a picture if the shutter speed is too low for hand-held photography according to the focal length of the lens.

### Built-in Flash

- ◆ They offer a built-in flash with TTL control, red-eye reduction, and Off mode which disables the flash as well as an attached Speedlite. On the K2 and T2 in most modes, the flash automatically pops up when needed.
- ◆ They work with EX-series Speedlites for sophisticated E-TTL flash metering (E-TTL on the Rebel T2) and enhanced flash performance. FE-Lock reads and briefly stores AF and metering information to give you more leeway in composing a shot, and high-speed sync allows them to synchronize the Speedlite with very fast shutter speeds to create impressive freeze-frames or enable the use of a wide aperture for shallow depth-of-field.



## OPTIONAL ACCESSORIES

**BP-8 Battery Pack (CABP8):** Lightweight, compact battery pack for the Rebel GII. It is a cost-efficient power supply, requiring only 4 AA alkaline or nicad batteries. Up to 100 rolls of 24-exposure film can be shot with alkaline batteries (75 with nicads) .....**29.95**

**BP-220 Battery Pack (CABP220):** Designed for the Rebel K2/T2, the BP-220 uses 4 AA or NiMH batteries to work as an additional power source. Also functions as a vertical grip for the cameras with a shutter release button and on/off switch.....**34.95**

**GR-80TP Grip (Rebel GII only) (CAGR80TP):** A new concept in grips, the GR-80TP incorporates a mini tripod, making it ideal for self-timer, low-angle or night photography. The inclination can be adjusted right, left, up and down. When the tripod is folded, it is integral with the body. Use with the hand strap to ensure a secure grip .....**44.95**

**RS-60E3 Remote Switch (CARS60E3):** A compact remote switch with a 2' cable replicating all the functions of the camera's shutter release button .....**25.95**

**RC-1 Wireless Remote Controller (Rebel K2/T2 only) (CARC1):** This is a miniature infra-red transmitter. It operates at ranges up to 16.4', and may be set for either instant shutter release or 2-second delay. The RC-1 can also be used to activate mirror lock and bulb shutter functions .....**24.95**

**RC-5 Wireless Remote Controller (Rebel K2/T2 only) (CARC5):** Compact, infrared remote control lets you fire the camera up to 16' away .....**21.95**

**Angle Finder C (CAFAC):** Lets you adjust the viewing angle while providing a full screen image that also shows exposure data. Includes built-in dioptic adjustment. ....**179.95**

**Eyecup Eb (CAECEB):**  
For Rebel GII. For soft eye contact even when wearing glasses .....**11.95**

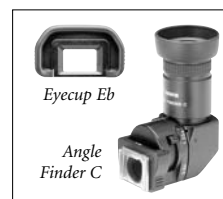

**Eyecup Ef (CAECEf):**  
For Rebel K2/T2. For soft eye contact even when wearing glasses.....**10.95**

**Rubber Frame Eb (CAFEB):**  
For Rebel GII with E-series diopter lenses .....**9.95**

**Rubber Frame Ef (CAFEFd):**  
For Rebel K2/T2 with E-series diopter lenses ....**9.95**

**Dioptic Adjustment Lens E:** Provide near and far-sighted users a clear viewfinder image without their glasses. Available in nine types from +3 to -4 dpt to match your eyesight, each diopter fits into the eyepiece holder of the appropriate EOS camera for convenient use and a comfortable fit. For 0 use #CAD0E, or simply insert number in the parenthesis after P for plus CADP( )E or M for minus CADM( )E diopters .....**13.95 ea.**



**EQUIPMENT LEASING AVAILABLE**

# CANON

## EOS REBEL SERIES SPECIFICATIONS

CAMERAS & LENSES

13

|                                    | EOS Rebel T2   | EOS Rebel K2  | EOS Rebel GII  |
|------------------------------------|--|---|--|
| <b>Autofocus System</b>            | TTL-CT-SIR (Through-The-Lens Cross-Type Secondary Image Registration)<br>Auto switching between One-shot and AI Servo AF with Focus Prediction.<br>Manual focusing confirmation possible with EF lenses. Automatic and manual focusing point selection.            |   | TTL-SIR-Multi-BASIS  |
| <b>Number of Focusing Points</b>   | 7 (with red illumination)  | 7   | 3  |
| <b>Autofocus Sensitivity</b>       | EV 1-18 (at ISO 100 with f/1.4)  | EV 1-18 (at ISO 100 with f/1.4)   | EV 2-18 (at ISO 100 with f/1.4)  |
| <b>Autofocus Auxiliary Light</b>   | Built-in   | Built-in  | Built-in   |
| <b>Shutter</b>                     | Vertical-travel focal plane shutter with all speeds electronically-controlled  |   |  |
| <b>Shutter Speeds</b>              | 30-1/4000 sec. + Bulb,   | 30-1/2000 sec. + Bulb, manually selectable in 0.5EV increments  |  |
| <b>Maximum Flash Sync Speed</b>    | X-sync at 1/125 sec.   | 1/90 sec.; high-speed sync available with EX-series Speedlites  |  |
| <b>Film Loading</b>                | Film automatically precwound to the end of the roll when loaded, rewinds one frame at a time during shooting   |   |  |
| <b>Film Winding Modes</b>          | Single and 3.0 frames/sec.   | Single and 1.5 frames/sec.  | Single and 1.0 frame/sec.  |
| <b>Film Rewind</b>                 | Automatic. Film automatically rewinds at end of roll. Mid-roll rewind possible   |   |  |
| <b>Metering System</b>             | TTL full aperture metering;<br>35-zone Evaluative metering;<br>9.5 % partial area metering;<br>Center-weighted average metering<br>(in manual mode only);  | TTL full aperture metering;<br>35-zone Evaluative metering;<br>9.5 % partial area metering;<br>Center-weighted average metering<br>(in manual mode only); | TTL full aperture metering;<br>6-zone Evaluative metering;<br>9.5 % partial area metering;<br>Center-weighted average metering<br>(in manual mode only); |
| <b>Metering Sensitivity</b>        | EV 1-20 (at ISO 100 with f/1.4)  | EV 1-20 (at ISO 100 with f/1.4)   | EV 2-20 (at ISO 100 with f/1.4)  |
| <b>Exposure Compensation</b>       | +/- 3 steps in 0.5 EV increments   | +/- 2 steps in 0.5 EV increments  | +/- 2 steps in 0.5 EV increments   |
| <b>AE Lock</b>                     | Yes  | Yes   | Yes  |
| <b>Exposure Modes</b>              | Intelligent program AE with variable shift; Shutter-priority AE; Aperture-priority AE; Auto Depth-of-field AE;<br>Programmed Image Control (7 settings for Rebel T2 and Rebel K2, 6 settings for Rebel GII);<br>Metered manual; E-TTL, A-TTL, TTL program flash AE |   |  |
| <b>Viewfinder Coverage</b>         | 90% horizontal and vertical at 0.70x   | 90% horizontal and vertical at 0.70x  | 90% horizontal and vertical at 0.70x   |
| <b>Viewfinder Information</b>      | <i>Inside the picture area:</i><br>7 focusing points,<br>plus 9.5% partial metering circle.  | <i>Inside the picture area:</i><br>7 focusing points,<br>plus 9.5% partial metering circle.<br>Active AF point indicator                                  | <i>Inside the picture area:</i><br>3 focusing points,<br>plus 9.5% partial metering circle.<br>Active AF point indicator                                 |
| <b>Focusing Screens</b>            | New laser-matte screen marked with focusing points (with partial metering circle)  |   |  |
| <b>Body Dimensions (W x H x D)</b> | 5.1 x 3.5 x 2.5"   | 5.1 x 3.5 x 2.5"  | 5.7 x 3.6 x 2.5"   |
| <b>Weight (Body Only)</b>          | 12.9 oz.   | 12 oz.  | 12.3 oz.   |

## EOS REBEL SERIES PRICING

**EOS Rebel GII Body (CAERG2):**  
Includes wide strap and Eyecup Eb .....Call

**EOS Rebel GII Kit (CAERG23580K):** Includes GII body, Canon  
35-80mm f/4-5.6 EF III Lens and two 3v lithium batteries.....Call

**EOS Rebel K2 Body (CAERK2):**  
Includes wide strap and Eyecup Ef .....149.95

**EOS Rebel T2 Body (CAERT2):**  
Includes wide strap and Eyecup Ef .....189.95

**EOS Rebel K2 Kit (CAERK22880K):** Includes K2 body, Canon 28-80mm  
f/3.5-5.6 EF II Lens and two 3v lithium batteries .....Call

**EOS Rebel T2 Kit (CAERT22890K):** Includes T2 body, Canon 28-90mm  
f/4.0-5.6 EF III Lens and two 3v lithium batteries.....259.95

**EOS Rebel K2 Body with Databack (CAERK2D):**  
Includes wide strap and Eyecup Ef .....169.95

**EOS Rebel T2 Body with Databack (CAERT2D):**  
Includes wide strap and Eyecup Ef .....214.95

**ORDER & INFO. (212) 502-6340 • FAX: (212) 239-7770 (800) 947-7008  
1-800-290-6750 • www.bhphotovideo.com**





# CANON

## ELAN 7N/ELAN 7NE

### Take Your Pictures to the Next Level

With an industry leading combination of performance and design, Canon's EOS series of SLR cameras continue to set new standards for digital and film SLRs. Celebrated for their unparalleled performance and sophisticated innovation, Canon EOS cameras have a well-deserved reputation for user friendly design, professional precision and uncompromising quality. Now add two more—the EOS ELAN 7N/7NE — to this amazing camera system. Incorporating a host of new features the ELAN 7N/7NE offer a new focusing system for the fastest AF performance in its class, a new backlit display, Canon's Whisper Drive technology, and a new distance-based flash metering system, all in a nearly silent, elegant and rugged package.



### FEATURES

#### Fast AF Performance

It's never been so easy to achieve perfect focus so quickly. A perfect choice for sports and wildlife photographers, the EOS ELAN 7N/7NE shares much of the AF technology found in Canon's EOS-1v and EOS 3. This high-speed focus can track quickly moving objects with great precision, allowing you to shoot up to 3.5 fps in AI Servo AF, or 4 fps in One-Shot AF mode. So whether your subjects are moving or stationary, the EOS ELAN 7N/7NE easily has the fastest AF in its class. And with AI Servo, One Shot and AI Focus modes, the AF system can adapt to any situation.

**AI Servo AF** lets you capture fast moving subjects. The camera follows the subject continuously until the shutter is released, continuously adjusting focus for sharp results, at speeds rivaling many professional SLRs.

**One-Shot AF** is suited to portrait or still life photography. Once composition is determined, one of the camera's seven focusing sensors quickly focuses on the subject. Unlike cameras with fewer focusing points, the ELAN 7N/7NE allows off-center subjects to be in sharp focus without the need to recompose the image.

**AI Focus** offers control in any situation. In this mode, the ELAN 7N/7NE detects if there is subject movement. Then, it automatically selects AI Servo Focus or One-Shot AF as the shooting situation requires.

#### 7-Point Wide-Area AF

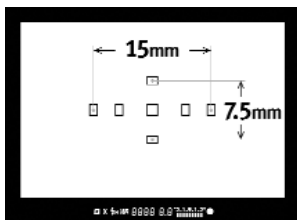

◆ The ELAN 7N/7NE's 7-point Wide-Area Autofocus provides a new level of speed and accuracy in AF. Seven focusing points are arranged in a cross pattern with a central "cross-type" sensor. This wide area makes it possible for sharp focus to be achieved instantly—even when the subject is off-center—without the need to recompose the shot. Vertically or horizontally, with stationary or moving objects, in low light and even with low contrast, 7-point Wide-Area AF delivers razor-sharp images.

◆ The ELAN 7N/7NE's Focusing Point Selection Keys represent a bold innovation in speed and versatility. Designed for easy and fast action, these keys enable the photographer to immediately select any one of the seven focusing points simply by pressing a button. It's simple, intuitive and remarkably fast.

#### Superior Metering

The ELAN 7N/7NE feature a 35-zone metering system, which is then linked to the camera's focusing points. To assure the highest level of contrast and clarity, Canon's AIM (Advanced Integrated Metering) system integrates evaluative metering and focus information. But whether using automated 35-zone, partial-area, or center-weighted metering, the ELAN 7N/7NE assures that your exposures come out just right.

#### 35-zone Evaluative Metering:

The ELAN 7N/7NE uses Canon's advanced 35-zone Evaluative Metering for fast, accurate control of shooting environments that combine light and shadow or strong backlight. Precise metering is assured whether shooting in vertical or horizontal positions.

#### Partial-Area Metering:

Partial metering measures 10% of the viewfinder at the center or around the chosen focusing point to provide pinpoint accuracy when metering shadows, highlights or subjects against very bright or dark backgrounds.

#### Center-Weighted Metering:

With center-weighted metering, the ELAN 7N/7NE measures the entire scene while placing greater emphasis on what appears in the center of the frame. It is often the chosen method of experienced photographers.

# CANON

## ELAN 7N/ELAN 7NE

### Enhanced Functions

In addition to sophisticated focus and exposure capabilities, they feature a host of other functions to enhance the photographic experience. Features like AE lock, Auto Exposure Bracketing and Multiple Exposure Control ensure that the ELAN 7N/7NE can do anything you want it to.

- ◆ AE Lock make it possible to meter and “lock in” and exposure setting based on a specific element of the composition, and then to recompose the shot for greater freedom of expression.
- ◆ AEB (Auto Exposure Bracketing) lets you select the degree of under or overexposure in the bracketing sequence—from 1/2 to 2 full stops in 1/2 stop increments. The camera then automatically fires three shots in rapid succession (the first at proper exposure, the next two at the selected increment of under and overexposure), ensuring correct exposure in complex lighting situations.
- ◆ Multiple Exposure Control (ME) allows the creation of dazzling, surreal effects by recording up to nine images on a single frame of film.
- ◆ Self-timer delays the shutter for ten seconds to allow the photographer to enter the composition, or to minimize shake for slow exposures.
- ◆ Canon’s Whisper Drive quiet film transport technology minimizes film advance noise, even when shooting in continuous mode, making the ELAN 7N/7NE the quietest EOS on the market!
- ◆ The viewfinder has a built-in dioptic adjustment from -2.5 to +0.5. Adjustments can be made conveniently without removing the camera’s attached eyecup.
- ◆ Depth-of-Field Preview button enables a fast check of the “sharp zone” before the shutter is released.
- ◆ The ELAN 7N/7NE has 13 different Custom Functions, encompassing 34 different settings that enable you to create a working relationship with the camera that’s highly individual.
- ◆ “Ultra-Matte Coating”, a black textured finish, has been added to the cameras, to distinguish them physically from the older EOS ELAN 7 and ELAN 7E models.

### Eye Control (ELAN 7NE Only)

Use the ELAN 7NE’s exclusive Eye Controlled Focus for instant, intuitive AF in almost any situation. Designed by Canon to link eye movement with the seven AF points, the Eye Control focus system tracks the glance of the eye, integrating composition and focus into one uninterrupted step. Canon’s fastest Eye Control system to date, it works whether the camera is oriented horizontally or vertically. This high-speed, advanced Eye Control system distinguishes the ELAN 7NE from every other camera in its class.

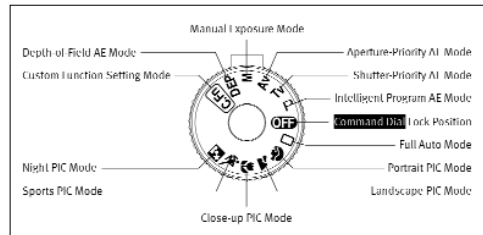

manual operation, click the Command Dial over to the Creative Zone.

### Command Dial

Use the ELAN 7NE’s Command Dial to set the camera to any kind of photographic situation. For beginners, or seasoned photographers confident that the camera will make the right choices for them, choose one of the fully automatic functions in the Image Zone. For more user-controlled features, including fully

### Image Zone

Programmed Image Controls (PIC) offer you greater speed and creative freedom—especially when shooting under tight time constraints. Just turn the Command Dial to the icon best suited to the shooting requirements: Portrait, Landscape, etc. A preset combination of AF, exposure control, metering patterns, and flash provides precise, effortless image control.

**Full Auto Mode:** chooses all settings including the correct combination of aperture, shutter speed and focus, as well as flash, for point-and-shoot simplicity.

**Portrait Mode:** sets a large aperture focusing on the subject’s face as it blurs the background for dramatic, flattering effect.

**Landscape Mode:** provides complete depth-of-field so everything is in sharp focus from foreground to background.

**Close-up Mode:** captures the smallest details at close range to reveal the textures and patterns in ordinary objects.

**Sports Mode:** sets the fastest possible shutter speed to freeze the action in front of you

**Night Scene Mode:** fires the flash and slows the shutter speed to produce “after dark” photos with bright foregrounds and gently glowing backgrounds.

### Creative Zone

With a flick of the ELAN 7N/7NE’s Command Dial, you have fast, effortless control of light, speed, aperture and depth-of-field.

**Intelligent Program AE:** selects the precise shutter speed and aperture value for the focal length of the lens—when you want to shoot at a moment’s notice.

**Shutter Priority AE:** you choose a shutter speed – up to 1/4000 of a second – and the camera automatically selects the correct aperture, allowing you to freeze motion or create intentional blurs.

**Aperture-Priority AE:** when control over depth-of-field is essential, this mode lets you select an aperture setting while the camera automatically matches it with the proper shutter speed.

**Depth-of-Field AE:** this mode calculates the precise depth-of-field automatically. With the ELAN 7e, you can even define your “sharp zone” using Eye Controlled Focus.

**Manual:** this is when you want complete control. You select the shutter speed and aperture setting. Use the analog metering scale and the ELAN 7N/7NE’s sophisticated metering system, or set exposure independently.

# CANON

## ELAN 7N/ELAN 7Ne

### *E-TTL Wireless Flash*

E-TTL Wireless enables you to work with two or more 550EX, 420EX or MR-14EX Speedlites to create dramatic studio quality lighting effects without the studio. Simply attach a 550EX, MR-14EX or an ST-E2 Transmitter to the ELAN 7N/7Ne and position the other Speedlites around your subject. You can use an unlimited number of Speedlite 550EX or 420EX (slave units) to achieve precise main, fill and background lighting. When you shoot, the on-camera Speedlite or Speedlite Transmitter functions as the master unit and transmits wireless signals to the slave units. To achieve your effect, the master unit's flash (550EX or MR-14EX only) can be disabled, however even when disabled it can still transmit wireless signals to the slave units for complete versatility.

The ST-E2 Speedlite Transmitter is a compact master control device for a wireless Speedlite flash system. This dedicated transmitter controls up to 3 groups of Canon EX-series Speedlites as slave units at distances of up to 33' outdoors and up to 50' indoors. Its shoe lock lever and locking pin provide easy clip-on mounting.

### *EOS System*

The ELAN 7N/7Ne camera is a perfect entry into the EOS system, the most comprehensive SLR system available today. There are more than 50 EF lenses compatible with the ELAN 7N/7Ne as well as Canon's superlative Speedlites and other accessories.

Canon's EF lenses are unsurpassed in value and quality. The choice of professionals and hobbyists worldwide, Canon EF Lenses are masterpieces of innovative design and superior optics. Ultrasonic Motor Technology (USM) offers instant focus, with nearly-silent operation. Image Stabilizer (IS) lenses eliminate camera shake, enabling you to shoot at slower speeds, often without a tripod in situations where one might have been warranted.

The EF 28-105mm f/4-5.6 and EF 28-90mm f/4.5-5.6 II lenses are perfect companions for the EOS ELAN 7N/7Ne. Their lightweight, high-quality designs were specially created to take full advantage of the camera's unique features. Both lenses offer virtually silent operation, enabling you to shoot in environments where silence is essential.

### *Built-in Intelligent Flash*



Both the ELAN 7N and 7Ne have a powerful and convenient built-in flash that pops up and fires automatically in Full-Auto, Portrait, Night Scene and Close-up modes. Automatic exposure controls set aperture, shutter speed and flash intensity. With range to cover as wide as a 28mm lens, the flash has a guide number of 42.6 (feet, ISO 100). Using standard off-the-film TTL flash control, this flash recycles in just two seconds. A red-eye reduction lamp fires before the flash for more natural-looking portraits.

### *E-TTL II Auto Exposure Flash System*

The ELAN 7N/7Ne go beyond any previous EOS 35mm SLR with Canon's new distance-based E-TTL II flash metering system. Attach any EX-series Speedlite, and most Canon EF lenses (must be compatible EF lenses with built-in distance information encoder) provide distance information to the camera — insuring that direct flash exposures are more accurate than ever before. Distance-based E-TTL II is especially powerful when shooting abnormally light or dark subjects.

- ◆ This "smarter" system compares the ambient light with the reflected pre-flash off the subject reported in all the metering zones and selects the areas with a small difference to be weighted for flash exposure calculation. The system also eliminates or underweights areas with large difference, recognizing them as an extremely reflective object in the background or as a highly reflective subject, by smartly ensuring it by considering the distance information data provided from compatible EF lenses.
- ◆ Similarly, in cases where photographers lock focus and recompose the shot, this revised E-TTL system prevents over-exposure by considering the flash output level calculated according to the broader distance information rather than using the single AF point.
- ◆ Canon's E-TTL II provides flash performance no other camera in this price category can match. Shoot flash pictures with full automatic exposure, using FP (hi-speed sync), up to the camera's top speed 1/4000 of a second. Take 10% partial readings of flash illumination and lock them into memory with Flash Exposure lock (FEL). Or use anywhere from one to an unlimited number of 550EX and/or 420EX speedlites off-camera, and not only have fully automatic exposure control, but even vary flash ratios over a six-stop range — without ever touching an off-camera flash unit!
- **FEB (Flash Exposure Bracketing):** Ideal when perfect exposure is critical. With a 550EX or MR-14EX/MT-24EX Ring Lite attached to the ELAN 7N/7Ne, FEB shoots three shots in a row—the first at proper exposure, the next underexposed, the last overexposed—in 1/2 stop increments from 1/2 to 2 full stops, assuring the correct amount of flash will be recorded.
- **FP Flash (High-speed Sync):** Perfect for freezing motion, shooting with shallow depth-of-field, or for eliminating ambient light to isolate subjects. In this mode, the EX-series Speedlites provide full range shooting at high shutter speeds up to 1/4000 second!
- **FE Lock (Flash Exposure Lock):** With an EX-series Speedlite attached, the AE Lock button functions as an FE Lock. Pushing the AE Lock button stores the proper flash exposure data in the camera's memory, the composition can then be fine-tuned and shot without having to re-meter the scene.



# CANON

## ELAN 7N/ELAN 7NE

### EOS ELAN 7N PRICING

EOS Elan 7N Camera Body (CAEE7N)  
With wide strap and Eyecup Ed .....299.95

EOS Elan 7N Camera Kit (CAEE7N28105K)  
Includes EOS Elan 7N Body, 28-105mm f/4-5.6 EF lens and two 3v  
lithium batteries .....409.95

### EOS ELAN 7NE PRICING

EOS Elan 7NE Camera Body (Eye Control) (CAEE7NE)  
With wide strap and Eyecup Ed.....339.95

EOS Elan 7NE Camera Kit (CAEE7NE28105)  
Includes EOS Elan 7NE Body, 28-105mm f/4-5.6 EF Lens and two 3v  
lithium batteries .....459.95

## Optional Accessories

In addition to full compatibility with Canon EF lenses and EX Speedlites, the ELAN 7N/7NE are compatible with a wide range of EOS system accessories, including battery packs, remote controllers and eyepieces.

**123A 3v Lithium Battery (GB123A):** The Elan 7N/7NE body requires only two.....3.99 ea.

**BP-300 Battery Pack (CABP300):** Designed exclusively for the ELAN 7N/7NE, the optional BP-300 Battery Pack has a comfortable vertical grip with controls including shutter release and AE Lock. Compact and lightweight, it accepts four "AA" batteries or two CR123A lithium batteries .....69.95

**RS-60E3 Remote Switch (CARS60E3):** A compact remote switch with a 2' cable replicating all the functions of the camera's shutter release button.....25.95

**RC-1 Wireless Remote Controller (CARC1):** A miniature infrared transmitter that operates at ranges up to 16.4', and may be set for either instant shutter release or 2-second delay. The RC-1 may also be used to activate mirror lock and bulb shutter functions .....24.95

**RC-5 Wireless Remote Controller:** Compact, infrared remote control lets you fire the camera up to 16' away.....21.95

**Angle Finder C (CAFAC):** Lets you adjust the viewing angle while providing a full screen image that shows exposure data. Includes built-in dioptic adjustment ...179.95

**Eyecup Ed (CAECED):** Made of hollow rubber for soft eye contact even when wearing glasses..... 13.95

**Eyecup Ed-E (CAECEDE):** Large eyecup designed for the ELAN 7N/7NE, it keeps out most sunlight and other external light, substantially enhancing viewfinder visibility. Especially helpful for eyeglass wearers when photographing outdoors. The mount can be rotated for vertical shots .....19.95

**Anti-Fog Eyepiece Ed (CAEPAFE3):** Attaches easily to reduce condensation and help you maintain a clear view of your subject in cold or humid weather .....39.95

**Dioptic Adjustment Lens Ed (with rubber frame):** Provides near and far-sighted users a clear viewfinder image without their glasses. Available in ten types from +3 to -4 dpt to match your eyesight. Fits into the eyepiece holder of the ELAN 7N/7NE (see bottom of page 27 for ordering information) .....9.95

**EH-14L Semi-Hard Case (CACLEE7):** Eveready case that provides basic contact and abrasion protection while on the go .....49.95

**Zoom Pack 1000 Holster Case (CAZP1000):** Protects your gear from moisture, impact and dust. The bottom is double layered for extra coverage.....24.95



# CANON

## EOS-1v/EOS-3

*The EOS-3 represents the cutting edge of autofocus technology. A 45-point autofocus ellipse dominates the center of the viewfinder, and it is remarkably accurate.*

*The user can select specific points, as on the EOS-1v, let the computer decide, or use the eye controlled focus to let the camera detect eye movement and move the autofocus to where you look. Missing a split-second off-center decisive moment is almost impossible*

*The EOS-3 features an area AF system, a high precision focusing system, higher speed eye-control and improved high-speed focus tracking. Superb weather-resistance capability, allow it to be used in the worst of conditions. Use Canon's latest Speedlites at all shutter speeds for fast action or wide-aperture daylight portraits with fill flash. Finally, the EOS-3's design is sturdy with easily accessible controls for quick and easy execution of camera operations. For convenience, it shares layout design, focusing screens, boosters and other accessories with other professional EOS models. These technologies combined with compatibility with the extensive range of EF lenses and accessories, make the EOS-3 the perfect choice for advanced amateurs and professionals alike.*



There is no doubt that the history of Canon's EOS system is the true measure of AF-SLR evolution. Seventeen years have passed since the birth of the first EOS in 1987. Throughout this time, Canon has relentlessly pursued EOS development based on the goal of matching system operability and performance to the speed and flexibility of human intellect and physiology. Canon has developed unique and innovative technologies that share a common objective: making fine photographs easier to take. Canon's achievements in camera and lens design, development and manufacturing technologies, in addition to many other areas have set lofty standards for the entire photographic industry and have also resulted in consistent market leadership.

*Canon's EOS camera's are the choice of professionals around the world. As the pros know, Canon sets the standard, consistently redefining photographic excellence through new technological developments. That's why Canon's top SLR has a "1" in the name. Packed with advanced features and functions, and with unprecedented operability, the 35mm EOS-1v—the "V" stands for "vision"—is capable of handling any shooting condition with flexibility and reliability.*

*From recording the moments when history is made to capturing nature in vivid detail, the EOS-1v transforms fleeting moments into images of visual perfection. With the EOS-1v, you'll reach a level of perfection where you, the subject and camera become one.*

*In developing the EOS-1v, Canon drew on it's accumulated know-how and the latest technological innovations to set new creative parameters to strengthen the connection between intention and execution.*

*The EOS-1v boasts a level of durability never before possible, along with a 45-Point Area AF for exceptional speed and precision. And Canon brought all it's expertise in ergonomics to bear in the camera's design, which is optimized for the most natural hand movement during photography. With versatile basic functions for all professional needs, plus the ultimate in customization, the EOS-1v frees you to operate in creative mode at all times. The world's fastest continuous shooting speed, at a maximum of 10 fps, gives the EOS-1v performance that no other camera of its type can match.*

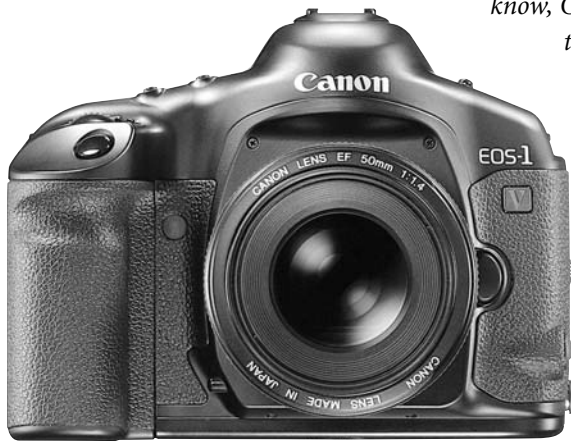

**ONE HOUR FREE PARKING**  
AT 349 W. 34th STREET (with purchase of \$100 or more)

# CANON

## EOS-1v/EOS-3

### 45-point Area AF

The result of Canon's pursuit of an AF system that allows continuous shooting ease and expanded framing freedom, the 45 focusing points are densely packed within an 8 x 15mm zone and can be manually or automatically selected to meet the needs of the situation. When multiple points are selected, AF system capabilities are significantly extended. While photographers have the freedom to frame images through the viewfinder as they choose, the lens is automatically brought into focus as soon as the active focusing points cover the subject. Like a human eye, Canon's 45-point Area AF tracks and aims true. This is typical of Canon's state-of-the-art AF technology, recognized by professional photographers everywhere. The system is comprised of two kinds of sensor elements that are capable of remarkable focusing efficiency. Because they are able to complement and compensate for each other, they vastly expand the range of lens/extender combinations with AF capability.

- ◆ Each of the 45 focusing points within the Area AF is composed of horizontal line detection sensors. These sensors operate with EF lenses having a maximum aperture of  $f/5.6$  or larger. They are particularly well-suited to focusing on moving subjects.
- ◆ The central seven points of the Area AF sensor also incorporate vertical line detection sensors, six of which operate with EF lenses with maximum apertures of  $f/2.8$  or larger and theoretically provide focusing precision three times as high as the vertical sensors.

### One-Shot AF (for stationary subjects)

- ◆ At its simplest level, all 45 focusing points can be used simultaneously for optimum auto focus results. Focusing of this kind has the power to transform a simple snapshot into a precisely balanced image. However, the true benefits of 45-point focusing become more apparent when applied to more demanding situations.
- ◆ The 45 focusing points of the EOS-1V provide unique functionality and a new level of focusing control. This system minimizes the problems of focus lock and recomposition, and brings an improved degree of fluidity to the creative process.

- ◆ The design of the Area AF sensor effectively creates seven cross-type central points capable of unrivaled object recognition and exceptional accuracy. The central focusing point is capable of cross-type focusing with EF lenses having a maximum aperture of  $f/4$  or greater, or focusing with horizontal component detection with EF lens/extender combinations having a maximum aperture as small as  $f/8$ . The result is an Area AF sensor system ideally equipped for excellent performance regardless of subject pattern; a system that brings out the true potential of Canon EF lenses and lens/extender combinations.

### AI Servo AF (for tracking moving subjects)

- ◆ The predictive AI Servo AF system allows the tracking of fast-moving objects while maintaining precise focus. Sequential processing regulates an array of events within the exposure process, including the arithmetic processing of AE and AF, the driving of the lens, aperture control, and movement of the mirror and shutter curtains.
- ◆ The precision and focusing accuracy of the AI Servo AF system functions within a high level of synergy for results that are nothing short of incredible. Using the EF 300 mm  $f/2.8$ L IS USM lens, they can pursue, focus and continually shoot an approaching subject at speeds of up to 30 mph until it's as close as 26' away.



## EOS-1v and EOS-3 Exclusive Focusing Features

### EOS-1V: Focusing Assist Button



It's easy to switch to a preselected focusing point simply by pressing the Assist Button. When shooting conditions fluctuate, or fleeting photo opportunities arise, even the most agile photographer will be hard pressed to select just the right focusing point in time. Fortunately, the EOS-1V allows users to register any focusing point as a home position (HP) that can be restored from any focus setting, with a single press of the Assist Button. This extremely handy feature allows photographers to adapt quickly to almost any situation.

### EOS-3: Eye Control Response

Eye Controlled Focus is a feature that lets the 45-Point Area AF exhibit its full value.





# CANON

## EOS-1v/EOS-3

### Sophisticated Exposure Control

The EOS-3 and EOS-1v let you capture the light as you see it. Canon's exclusive AIM (Advanced Integrated Multi-Point Control) system integrates Area AF and all six metering modes available with the EOS-1v/3. Focus on a subject within the Area AF ellipse, and they will meter that area for the optimum result where it's needed most. All six metering modes use the 21-zone evaluative metering sensor. Six metering modes, six program modes and three flash metering modes capture your vision in all manner of lighting situations.

#### METERING MODES

##### 21-Zone Evaluative Metering

Offers efficient coverage of the focus area by defining the active focusing point as the main subject and setting independent metering areas for each of 15 major focusing points within the Area AF ellipse. By considering a range of metered values from adjacent areas, clearly capture the subject, even with various brightness levels in the frame.

##### Center-weighted Average Metering

Meters the brightness of all zones and calculates exposure from this reading. Metering is weighted: the farther the area is from the center, the lower the sensitivity.

##### Center Spot Metering

Center spot metering mode covers only 2.4% of the central image area, allowing precise metering of a very small portion of the subject. Idea for achieving the correct exposure for a subject in setting with sharp contrasts in brightness.

##### Multi-Spot Metering

Express personal preferences for subtle detail in both bright and dark areas when shooting images with significant differences in brightness contrast. Up to eight spot readings can be registered.

##### Focusing Point-Linked Spot Metering

Linked spot metering not only allows accurate metering that is unaffected by background brightness plus offers a high level of freedom for choosing composition.

##### Partial Metering at Center

In this mode approx. 8.5% of the central image is metered. The metering area is exceptionally well-defined, which makes it easy to judge the ideal exposure setting based on the brightness balance between the subject and the background. Ideal for those who want to set exposure manually.

#### AUTOMATIC AND MANUAL EXPOSURE MODES

To assist the creative freedom, they have no fully-automated mode that leaves all settings to the camera. Instead they are equipped with convenient AE modes that let you input your will while concentrating on your composition.

- ◆ **Program AE**—They automatically determine the optimum exposure according to the programmed combination of shutter speed and aperture setting. The program can be shifted easily by means of the Main/Quick Control Dials. While the camera remains at an optimum exposure setting, you can select a combination of shutter speed and aperture settings appropriate to the shooting situation.
- ◆ **Depth of-field AE**— This mode lets you manually select two focusing points for calculating the aperture value. This value is used for setting the depth of field at a level that ensures sharp focusing between the two points. Very helpful for portrait shots using a telephoto lens.
- ◆ **AEB (Auto Exposure Bracketing)** allows you to bracket three consecutive frames automatically up to  $\pm 3$  stops in 1/3- or 1/2-stop increments. The exposure level changes with each bracketed frame in the order of correct exposure, underexposure and overexposure. Ideal when there is complex lighting or using a narrow latitude film.
- ◆ **Shutter-speed Priority**—while you set the shutter speed (30 to 1/8000 sec.) the aperture is automatically adjusted.
- ◆ **Aperture Priority**—you set the aperture while the camera sets the optimum shutter speed. Effective mode for emphasizing depth-of-field.
- ◆ **Bulb**—essential for shooting night views, fireworks or for astronomical photography. It offers continual exposure for as long as the shutter button is fully depressed. Bulb exposure lapse time can be displayed on the large LCD pane for up to 23 hours, 59 minutes, 59 seconds.
- ◆ **Manual**— for complete control. You select the shutter speed and aperture setting.

#### FLASH METERING MODES

The EOS-3/ EOS-1v live up to their design philosophy of offering perfect connections between various systems with their two flash metering modes for the advanced E-TTL autoflash mode and the conventional A-TTL or TTL autoflash modes. The cameras make automatic selection between the two flash metering modes depending on the system connected to them.

- ◆ With an E-TTL Speedlite connected, they fire a pre-flash after metering ambient light, then meter the reflected light on the subject. The optimal flash rate is determined through a comparative calculation of the two metered values. The 21-zone metering sensor is used to meter both the ambient light on the subject and the pre-flash.
- ◆ 3-zone TTL off-the-film plane metering offers automatic exposure when shooting with A-TTL or TTL Speedlites. Reflected light on three zones of the film surface is metered using the TTL sensor. An optimal exposure compensation value is set for each zone limited to the focusing point, based on the result of this metering.

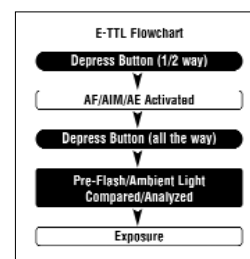

# CANON

## EOS-1v/EOS-3



### E-TTL Auto Exposure Flash System

E-TTL automatic flash exposure is also possible when an EX-series Speedlite is mounted. This enables great pictures to be taken with a flash even under difficult lighting situations. The camera is also equipped with a flash exposure compensation function and a first- and second-curtain synchronization switching function, that comes in handy when shooting a moving object in low light.

Canon's most advanced flash exposure control system, E-TTL (Evaluative through-the-lens) is a flash mode that reads through the lens, but not off the focal plane. This method provides several extra features such as Flash Exposure Lock (a method of spot metering with flash) and FP flash mode (the ability to use flash at high shutter speeds). Utilizing a preflash fired after the button has been fully depressed but before the camera's reflex mirror goes up, E-TTL uses the camera's evaluative metering sensor to analyze and compare ambient light exposure values with illumination reflected from the subject by the preflash. This data is used to calculate and store the flash output required for optimum exposure of the main subject, while maintaining a subtle balance between foreground and background.

#### FE Lock:

Light reflected from the subject by a pre-flash is measured with partial metering for optimum flash control. The main subject can therefore be photographed at the correct exposure even when a high-brightness portion exists in the background. Framing can also be performed without limitation.

#### High-speed Synchro Photography:

Attach the Speedlite 550EX and a high-speed synchro (FP flash) function is provided. This allows the use of electronic flash even at high shutter speeds. Backgrounds can be blurred intentionally using the high-speed synchro function to select a large aperture.

#### FEB (Flash Exposure Bracketing):

Without changing the background exposure level, the amount of flash illumination (using the Speedlite 550EX or Macro Ring Lites MR-14EX and MT-24EX) falling on the subject can be automatically changed as follows: standard, underexposure compensation, overexposure compensation. The compensation range is from -3EV to +3EV, in 1/3 or 1/2 step increments.

#### E-TTL Multiple Wireless Flash:

By using several 550EX Speedlite flashes, multiple flash photography, which normally requires a high level of sophistication, can be performed in full-auto mode.

### E-TTL Wireless

E-TTL Wireless enables you to work with two or more 550EX, 420EX or MR-14EX Speedlites to create dramatic studio quality lighting effects without the studio. Simply attach a 550EX, MR-14EX or an ST-E2 Transmitter to the EOS-1v or EOS-3 and position the other Speedlites around your subject. You can use an unlimited number of Speedlite 550EX or 420EX (slave units) to achieve precise main, fill and background lighting. When you shoot, the on-camera Speedlite or Speedlite Transmitter functions as the master unit and transmits wireless signals to the slave units. To achieve your effect, the master unit's flash (550EX or MR-14EX only) can be disabled, however even when disabled it can still transmit wireless signals to the slave units for complete versatility.

### Viewfinder

- ◆ Their viewfinders are designed to deliver all information at a glance. Active superimposition displays the focusing point on the 45-Point Area AF. The bottom of the viewfinder displays shutter speed, aperture settings, Eye Controlled Focus (EOS-3 only) and FP flash icons.



- ◆ The exposure compensation scale is positioned on the right side of the viewfinder. There is also a flash compensation scale which makes it possible to sense and control settings for fine differences in the balance of exposure between ambient lighting and your subject.
- ◆ Below the exposure scales is a double-digit counter that tracks the number of exposures taken on the roll of film. Using the custom functions, it is also possible to display the film count in reverse order to count down the remaining shots.
- ◆ The viewfinder of the EOS-3 offers 97% visual field coverage and a magnification ratio of 0.72x. The EOS-1v uses advanced materials to reduce the curvature of field and achieves 100% visual field coverage and a viewfinder ratio of 0.72x—both of which contribute to clear and easy viewing of the subject and accurate framing of the photograph.

### Built-in Dioptric Correction (EOS-1v only)

- ◆ Eyesight varies slightly over the course of each day and can also differ on a person's physical condition. Thus, the EOS-1v provides a dioptric correction mechanism on the viewfinder eyepiece that allows the photographer to make adjustments accordingly. Dioptric correction can be performed within a range of  $\pm 2$ dpt from the -1dpt default (-1dpt on the EOS-3 also).
- ◆ When shooting without reference to the viewfinder, or when utilizing the self-timer, you can employ the built-in (EOS-1v only) eyepiece shutter to help prevent incorrect exposure caused by unwanted incidental light entering through the viewfinder.

# CANON

## EOS-1v/EOS-3

### EOS-3

The EOS-3 features continuous shooting of up to 4.3 fps in One-Shot AF mode and 3.3 fps in AI-Servo AF. Attach the PB-E2 with AA batteries, the EOS-3 can shoot continuously at 6 fps in One-Shot AF and 5 fps in AI-Servo AF. Use the PB-E2 with the NP-E2 NiMH battery pack, and the EOS-3 achieves a maximum speed of 7 fps in either One-Shot AF or AI-Servo AF.

#### Active Mirror Control

Canon's Active Mirror Control method replaces the conventional approach of suppressing mirror bound shock from the rear. The ground-breaking mechanism reduces mirror shake, confining it to a short duration and suppressing the shake immediately after it occurs. As a result, mirror blackout time is remarkably reduced. Because the wave height of mirror shake is low after its bounce is suppressed, the finder image stabilizes quickly after the shutter is released in single and continuous shooting. The user always has a clear and sharp viewfinder image.

#### Shutter

Their electronically controlled rotary magnet shutter eliminate the possibility of operational trouble. It ensures constant operation that remains as accurate as its original performance even after long use and under severe shooting conditions. The shutter blades are made of carbon fiber and super-duralumin, for high reliability in all shooting conditions over extended use. This has been confirmed by in-house testing in which the unit recorded in excess of 150,000 shutter-cycles. The unit performs high-speed shutter operation with exceptional accuracy at a maximum shutter speed of 1/8,000 second and a maximum flash sync speed of 1/250 second.

### EOS-1v (HS)

The world's fastest camera, the EOS-1v features continuous shooting of up to 3.5 fps in One-Shot AF mode and 3 fps in AI-Servo AF.

Attach the PB-E2 with AA batteries and it becomes an EOS-1v HS shooting up to 6 fps in One-Shot AF and 5 fps in AI-Servo AF. Use the PB-E2 with the NP-E2 NiMH battery pack, and the EOS-1v HS achieves 10 fps and 9 fps respectively.



### PB-E2 Power Drive Booster (CAPBE2)

The PB-E2 is a high-performance motor drive that replaces the standard grip of the EOS-3 or EOS-1v when mounted. When powered with the NP-E2 NiMH battery pack, it delivers high-speed continuous AF shooting of up to 7 frames per second (fps) on the EOS-3 and 10 fps on the EOS-1v.

The booster's controls include a shutter button, AE lock button, focusing point selection button, and FE lock/multi-spot metering button. Vertical grip controls provide the same operating ease in the vertical as when used in the horizontal position. Plus the winding torque of film advance is automatically increased in cold temperatures or when battery power is running low to improve performance. The PB-E2 can also be powered by 8 AA-size alkaline, nicad, NiMH or lithium batteries.....**384.95**

**BM-E2 Battery Magazine (CABME2):** This magazine is dedicated to and comes with the PB-E2 Power Drive Booster. It holds eight size-AA alkaline, lithium, NiMH or Nicad batteries .....**49.95**

**NP-E2 NiMH Pack (CANPE2):** A large-capacity battery pack dedicated to the Power Drive Booster PB-E2, it can be recharged over 500 times. When fully charged, it has enough power for 70 rolls of 36-exposure film.....**124.95**

**NC-E2 NiMH Charger (CANCE2):** This dedicated charger quickly recharges the NP-E2 NiMH Pack, taking about 90 minutes for one pack. It also prevents excess charging. Two packs can be attached at one time. The discharge feature (taking about 8.5 hours) cancels the NP-E2 memory effect. Runs on 100-240v AC.....**319.95**

**BP-E1 Battery Pack (CABPE1):** A power-source switchable battery pack operable with a lithium 2CR5 and four size-AA batteries .....**129.95**

**GR-E2 Grip (CAGRE2):** Replacement grip for EOS-1v and EOS-3 that don't have a built-in power booster. Also required for the EOS 1v HS when the power booster is removed from the camera body .....**44.95**



BM-E2



NP-E2



NC-E2



BP-E1

### Maximum Continuous Shooting Rates

| Configuration  | Power Source            | One-Shot AF | AI Servo AF |
|----------------|-------------------------|-------------|-------------|
| EOS-1v         | 2CR5 lithium battery    | 3.5 fps     | 3 fps       |
| EOS-1v + BP-E1 | 4 AA Alkaline Batteries | 3.5 fps     | 3 fps       |
| EOS-1v + PB-E2 | NP-E2 NiMH Pack         | 10 fps      | 9 fps       |
| EOS-1v + PB-E2 | 8 AA Alkaline Batteries | 6 fps       | 5 fps       |
| EOS-3          | 2CR5 lithium battery    | 4.3 fps     | 3.3 fps     |
| EOS-3 + BP-E1  | 4 AA Alkaline Batteries | 4.3 fps     | 3.3 fps     |
| EOS-3 + PB-E2  | NP-E2 NiMH Pack         | 7 fps       | 7 fps       |
| EOS-3 + PB-E2  | 8 AA Alkaline Batteries | 6 fps       | 5 fps       |



EQUIPMENT LEASING AVAILABLE

# CANON

## EOS-1v/EOS-3

### EOS-1v CONSTRUCTION

#### Combines strength and elegance to deliver top performance regardless of the shooting environment

The EOS-1v was developed using the strongest available body materials for both functional attractiveness and high-level rigidity. The magnesium alloy used for the EOS-1v is lightweight, yet possesses exceptional strength. Although hard to machine, Canon uses an advanced injection molding technology called "thixo-molding" to mold the delicate curved surfaces of the EOS-1v body. This lightweight body is the perfect blend of rigidity, durability and total precision.

Rigid, reliable diecast aluminum is used for the lens mount on the front panel, and for the front mirror unit—areas critical to the precision of an SLR camera. The EOS-1v's reliability is heightened by its diecast aluminum body and a simplified structure that has no lens driving pin and processes all data electronically. Magnesium alloy is used for the distinctive top and front covers of the EOS-1v, and for the outside covers of the PB-E2 Power Booster. The structure encloses the inner workings with rigid covers, thus increasing internal strength and protecting system precision as a whole.

The EOS-1v was built to deliver top performance regardless of the shooting environment. All parts are precisely machined. The aperture and hybrid framework structure which serve as the base for various parts and fittings are diecast aluminum, with glass-fiber reinforced polycarbonate resin, which is equal in strength to metal. The main outside covers are made of magnesium alloy. The lightweight body benefits from remarkably improved rigidity, precision, and durability, realized by the optimum use of carefully chosen high-tech materials.

#### Sets the Standards for Water and Dust Resistance

Professional cameras must be impervious to sharp changes in temperature; they must also be resistant to water, sand and dust. They must work smoothly under a wide range of conditions. The EOS-1v has been developed and manufactured to reflect feedback from professional photographers who work in severe environments, as well as Canon's own expertise in this area.

Following a reassessment of the severity of conditions that may apply in some shooting situations, Canon has succeeded in raising the level of water and dust resistance. The 72 major body seams and moving parts, such as the shutter button, selector buttons and Main/Quick Control Dials, are carefully sealed with silicone rubber, and the edges of the back cover are thoroughly finished. Furthermore, the battery chamber located inside the new grip GR-E2 is protected by packing, while the insides of function buttons, found on the upper left of the body, are protected from dust and water by a silicone rubber boot.

The satisfyingly solid feel and sound of the back cover being closed will tell you that the EOS-1v stands up to the elements like no other camera.

In addition to shielding the moving parts and major seams in EOS-1v body against water and dust, complete measures were taken to secure the lens mount perimeter. The lens mount is protected by a water-resistant rubber O-ring. When the EOS-1v is used together with an IS super-telephoto lens, unrivaled performance is assured in a wide range of shooting conditions.

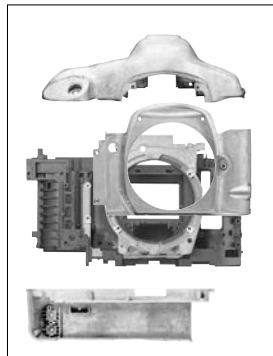

### EOS-3 CONSTRUCTION

#### Reinforced Body Construction

The glass-fiber reinforced polycarbonate resin body has die-cast aluminum inserts around the aperture area while exterior components are made of lightweight, rigid engineering plastic. Inner surfaces are coated in copper-plating to provide electromagnetic shielding. The body package as a unit is highly shock-resistant and well protected against noise as befits a camera that houses advanced electronics. In addition, both the front (including the grip) and rear covers of the PB-E2 Power Drive Booster are made of magnesium alloy. This tough, lightweight material also acts as an electromagnetic shield.



#### Water-Resistant and Dust-Proof

The greatest threats to a camera that is loaded with advanced electronics are exposure to environmental hazards such as rain and/or dust. The EOS-3 was built to exhibit superior protection against these threats and thereby provide the highest level of durability under even the severest shooting conditions.

All buttons and dials use rubber gaskets to block out drops of water. And for greater reliability, all the important electrical contacts are bipolar and gold-plated. To protect the heavily-used Main Dial, it too was designed to repel water away from it.

# CANON

## EOS-1v/EOS-3

### Custom Functions

- ◆ Variety is the spice of life. And even the same individual's preference can change depending on the conditions. This is the concept photographers desire in a camera. Ease of operation is an important feature. However, as long as the camera is used as a tool, it must respond to the desires of the photographer. Custom Functions serve to adapt the EOS-1v and the EOS-3 to your preference.
- The EOS-3 provides 18 custom functions that allow fine settings to match the shooting conditions or the user's preference.
- The EOS-1v features 20 custom functions that enable the input of 63 detailed selections and settings. On the EOS-1v, arbitrary setting of Custom Functions can be performed either on the camera itself, or on a personal computer with optional ES-E1 EOS Link Software installed.

### Ease of Operation

- ◆ They deliver high levels of performance while maintaining the basic form, operability, and logical dial and switch arrangements of all EOS SLR cameras ever made.



- ◆ Equipped with the optional PB-E2 Power Drive Booster, the EOS-3 and EOS-1v deliver the same operability when held in the vertical position as in the horizontal position.
- ◆ The EOS-1v and EOS-3 both benefit from Canon's commitment to offering unrivaled performance in all areas of photography. That means they accept the full range of EOS system accessories including viewfinder accessories, such as the focusing screens, Speedlites, and motor drive accessories.

## PC Customization (EOS-1v Only)

Designed exclusively for the EOS-1v, the optional ES-E1 EOS Link Software enables advanced customization, and management of shooting data, through PC connectivity. Simply link the EOS-1v to a PC (with EOS Link installed) via the supplied connecting cable and you can achieve various forms of customization, function extension and data download by following messages on the monitor screen. EOS Link software is comprised of two software applications:



### EOS-1v Remote (Personal Function Customization)



Allows advanced Personal Function customization, so the photographer can program the EOS-1v to reflect their own personal preferences, shooting purposes and conditions. Over 30 Personal Functions give even greater customized control over the EOS-1v than Custom Functions provide. With the optional EOS Link installed, you can change, extend and limit the functions of the EOS-1v. To customize your EOS-1v you need only to follow the menu and messages appearing on your monitor. EOS Link enables you to configure your EOS-1v like a custom-made camera.

### EOS-1v Memory (Exposure Data Management)

Intensive management of exposure data is readily achieved. Use EOS-1v Memory for downloading up to 25 different types of shooting data from the camera such as shutter speed and aperture, date, time and more with each frame of film Values are automatically saved in the camera's memory each time the shutter is released. At the same time, an arbitrary two-digit number and an auto-incrementing three-digit ID number are automatically imprinted on the film leader. This means the film and shooting data can be matched.

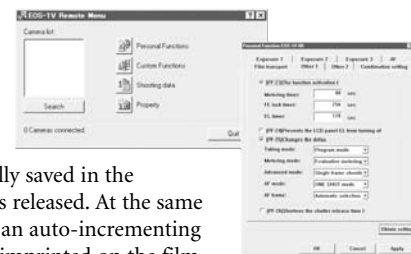

The storage capacity of the built-in memory varies depending on the number of items to be recorded. In general, data can be saved for 50 to 200 rolls of film with 36 exposures, with data for 100 rolls being recorded in the standard setting.

If all shooting data is input to a PC via the EOS Link software it can be managed intensively for reading and editing. If scanned images are attached as thumbnails to the shooting data, the arrangement and searching of data can be performed more quickly and efficiently. This software thus enables users to manage film data effectively.



For Any Inquiries Regarding Your Order, Call Our Customer Service:  
(800) 221-5743 • (212) 239-7765 • FAX: (800) 947-2215 • (212) 239-7549

## EOS-1v, EOS-3, EOS ELAN 7N/7NE SPECIFICATIONS

### EOS ELAN-1v PRICING

**EOS-1v Camera Body (CAE1V)**  
With wide strap RF3 body cap and Eyecup Ec-II .....1649.95

**EOS-1v Camera Kit (CAE1VHS):** Includes EOS-1v Body, PB-E2 power drive booster, RF3 body cap, wide strap and Eyecup EC-II .....1969.95

**EOS-1v Camera Kit (CAE1VK)**

Includes EOS-1v Body, PB-E2 power drive booster, RF3 body cap, GR-E2 grip, wide strap, AA Battery Magazine BM-E2 and Eyecup EC-II ...1979.95

### EOS-3 PRICING

**EOS-3 Camera Body (Eye Control) (CAE3)**

With wide strap, RF3 body cap and Eyecup ED .....874.95

**EOS-3 Camera Kit (CAE3K):** Includes EOS-3 Body, PB-E2 power drive

booster, RF3 body cap, wide strap and Eyecup ED .....1249.95

|                                    | EOS-1V  | EOS-3   | EOS ELAN 7N/NE  |
|------------------------------------|---|---|---|
| <b>Autofocus System</b>            | TTL-AREA-SIR CMOS Sensor. One-shot and AI Servo AF with Focus Prediction. Manual focusing confirmation possible with EF lenses. Automatic and manual focusing point selection   | TTL-AREA-SIR CMOS sensor. One-shot and AI Servo AF with Focus Prediction. Manual focusing confirmation possible with EF lenses. Eye Controlled Focus point selection, automatic focusing point selection and manual point selection.  | TTL-CT-SIR CMOS sensor. One-shot and AI Servo AF with Focus Prediction. Manual focusing confirmation possible with EF lenses. Focusing point selection by Eye Controlled Focus (7NE only), automatic focusing point selection and manual point selection.   |
| <b>Special Features</b>            | Custom Functions (20 custom functions with 63 settings; 3 user-set groups possible); Quick Control Dial; PC Link (with optional ES-E1 software); Auto Exposure Bracketing ( $\pm 3$ steps in 0.3 EV); Multiple Exposure; Depth-of-Field Preview; Mirror Lock; PC terminal; N3 remote control socket; EOS-1V HS includes accessory Power Drive Booster PB-E2 | Custom Functions (18 selectable features) Quick Control Dial; Auto Exposure Bracketing ( $\pm 3$ steps in 0.3 / 0.5EV increments); Multiple Exposure; Depth-of-Field Preview; Mirror Lock; PC terminal; N3 remote control socket; Accepts optional Power Drive Booster PB-E2                      | Metal exterior with Ultra Matte Coating; Electroform parts for the nameplate and top dials; Retractable built-in flash; Custom Functions (13 functions, 34 settings); Depth-of-Field Preview; Quick Control Dial; Auto Exposure Bracketing ( $\pm 2$ steps in 0.5EV increments); Multiple Exposure; Mirror Lock; Compatible with Battery Pack BP-300 and RS-60E3 Remote Control |
| <b>Focusing Points</b>             | 45 (Area AF Ellipse)  | 45 (Area AF Ellipse)  | 7 (with red illumination)   |
| <b>Built-in Aux. AF Light</b>      | —   | —   | Yes   |
| <b>Shutter Speeds</b>              | 30-1/8000 sec & Bulb, manually selectable in 1/3, 1/2 or 1-stop increments  | 30-1/8000 sec & Bulb, manually selectable in 1/3, 1/2 or 1-stop increments  | 30-1/4000 sec & Bulb, manually selectable in 1/2 stop increments  |
| <b>Max.Flash Sync Speed</b>        | 1/250 sec.; high-speed sync. available with EX-series Speedlites  | 1/200 sec.; high-speed sync. available with EX-series Speedlites  | 1/125 sec.; high-speed sync. available with EX-series Speedlites  |
| <b>Frames Per Second</b>           | Single and 3.5 fps.   | Single and 4.3 fps.   | Single and 4.0 fps.   |
| <b>Metering System</b>             | 21-zone evaluative metering, 8.5% partial area metering, 2.4% center spot metering, 2.4% spot metering (linked to user-selected focusing point, Multi-spot metering (up to 8 spot readings), Center-weighted average metering, Pre-flash metering (E-TTL), 3-zone off-the-film TTL flash metering   | 21-zone evaluative metering, 8.5% partial area metering, 2.4% center spot metering, 2.4% spot metering (linked to user-selected focusing point, Multi-spot metering (up to 8 spot readings), Center-weighted average metering, Pre-flash metering (E-TTL), 3-zone off-the-film TTL flash metering | 35-zone evaluative metering, Center-weighted average metering, 10% partial area metering, TTL/ A-TTL autofocus, Pre-flash metering (E-TTL II), 3-zone off-the-film TTL flash metering   |
| <b>Flash Exposure Compensation</b> | $\pm 3$ stops in 1/3 or 1/2-stop increments (works with all EOS Speedlites)   | $\pm 3$ stops in 1/3 or 1/2-stop increments (works with all EOS Speedlites)   | $\pm 2$ stops in 1/2-stop increments (works with all EOS Speedlites)  |
| <b>Viewfinder Coverage</b>         | 100% horizontal and vertical at 0.72x   | 97% horizontal and vertical at 0.72x  | 92% horizontal and 90% vertical at 0.70x  |
| <b>Self-Timer</b>                  | Electronically controlled with 2- or 10-second delay  | Electronically controlled with 2- or 10-second delay  | Electronically controlled with 10-second delay  |
| <b>Body Dimensions (WHD)</b>       | 6.3 x 4.7 x 2.8"  | 6.3 x 4.7 x 2.8"  | 5.8 x 4.0 x 2.7"  |
| <b>Weight (Body Only)</b>          | 33.3 oz.  | 27.5 oz.  | 20.3 oz.  |



# CANON

## EOS-1v/EOS-3 ACCESSORIES

### FOCUSING SCREENS

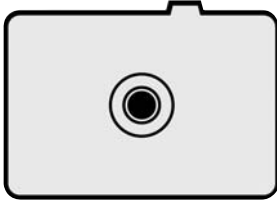

Ec-A Microprism

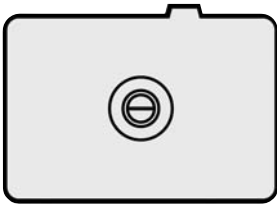

Ec-B New Split

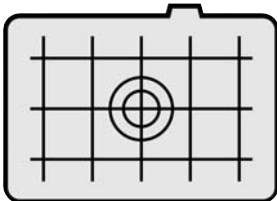

Ec-D Laser-Matte with Selections

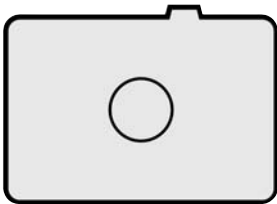

Ec-C II Standard Laser Matte

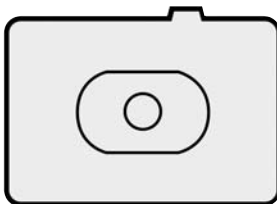

Ec-C III Laser-Matte

**Ec-A Microprism (CAFSAE1)**

Matte field with microprism focusing spot in the center. Used for general photography with all lenses, best results obtained when using an aperture of f/5.6 or faster.....32.95

**Ec-B New Split (CAFSBE1)**

Matte field with split-image focusing spot in the center. Used for general photography with all lenses.....32.95

**Ec-C II Standard Laser-Matte**

Matte field screen with spot metering mark in the center .....32.95

**Ec-C III Laser-Matte (CAFSCE1V)**

The standard screen that comes with the EOS-1v and EOS-1v HS, and compatible with all EF lenses. This screen includes an Area AF ellipse and spot-metering circle. Manual focus can be checked anywhere on the screen .....32.50

**Ec-D Laser-Matte with Selections (CAFSDE1)**

Matte field with sections. Grid lines assist in determining accurate picture composition. Especially suited for close-up photography or copy work using EF macro lenses. Can also be used for general photography with all lenses.....32.95

**Ec-H Laser-Matte with Scale (CAFSHE1)**

Matte field with vertical and horizontal scales marked in millimeters. Effective for close-up photography and photomicrography. Useful in determining magnification ratios and composition. Can be used with all lenses .....32.95

**Ec-I Laser Matte with Double Cross-Hair Reticle (CAFSIE1)**

Matte field with clear center spot containing double cross-hair reticle. Focusing is possible using the floating image of the central cross-hair. Use for photomicrography and astrophotography .....32.95

**Ec-L Cross-Split Image (CAFSLE1)**

Matte field with cross-split image in the center, which divides the subject in half both vertically and horizontally for accurate manual focusing. Used for general photography with all lenses, best results obtained when using an aperture of f/5.6 or larger.....32.95

**Ec-N Bright Laser-Matte (CAFSNE3)**

The standard screen that comes with the EOS-3. The outer oval-shaped area defines the coverage lot of the 45 AF points; the inner circle is for spot end FEL metering. When shooting, the focusing points will be indicated in red LCD markings. Along with the Ec-R screen, it is approximately 1/2-stop brighter than the other Laser-Matte series screens .....33.95

**Ec-R Overall Bright Laser-Matte (CAFSRE1NRS)**

This screen compensates for decreased viewfinder brightness due to the low reflection factor of the pellicle mirror. It is about 1/2-stop brighter but otherwise similar to the Ec-CIII focusing screen that comes standard with the EOS-1v and EOS-1v HS .....32.95

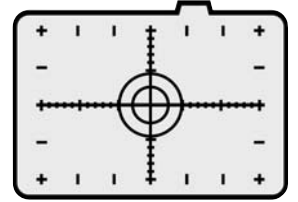

Ec-H Laser-Matte with Scale

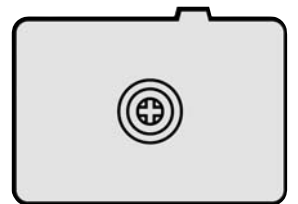

Ec-I Laser Matte/Double Cross

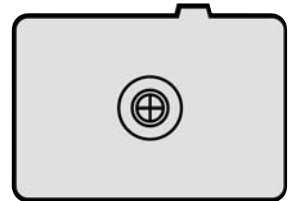

Ec-L Cross-Split Image

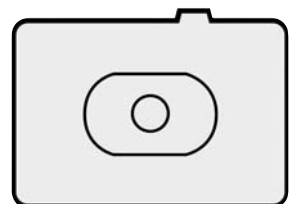

Ec-N Bright Laser-Matte

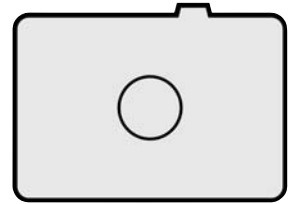

Ec-R Overall Bright Laser Matte

# CANON

## EOS-1v/EOS-3 ACCESSORIES

### VIEWING ACCESSORIES

For more customization, many of Canon's EOS cameras are compatible with a vast choice of eyecups, diopter lenses and more for greater versatility in a number of shooting situations.

#### Eyecup Ed

(Replacement) (CAECED):

For soft eye contact even when wearing glasses, for EOS-3 .....



13.95



#### Eyecup Ed-E

(CAECEDE):

Large eyecup designed for the EOS-3 it keeps out

most sunlight and other external light, substantially enhancing viewfinder visibility. Especially helpful for eyeglass wearers when photographing outdoors. The mount can be rotated for vertical shots.....

19.95

#### Eyecup EC-II

(Replacement)

(CAEC2): For soft eye contact even when wearing glasses, for EOS-1v .....



14.95

#### Rubber Frame EC

(CAFEC):

Replaces the standard eyecup on the EOS-1v when used with a Diopter Adjustment

Lens E .....

14.95

#### EP-EX15 Eyepiece Extender (CAEPEX15)

Designed for the EOS-1v, the EP-EX15 extends the eyepiece by 5/8" (15mm) from the camera



body and reduces viewfinder magnification by 30%. Useful for eyeglass wearers to prevent the tip of the nose from touching the camera body .....

17.95

#### Angle Finder C (CAFAC)

Lets you adjust the viewing angle, while providing a 2.5x magnification for critical focusing, or a full-screen image (1.25x) that includes exposure data. Provided with built-in diopter adjustment. Includes Ec-C & Ed-C adapters to fit any EOS camera .....



179.95

#### Anti-Fog Eyepiece Ec (CAEPAFE1)

Designed for the EOS-1v, the eyepiece prevents the fogging of the viewfinder lens in both extremely cold and hot climates. The anti-fog coating provides clear viewing under the severest conditions.....



39.95

#### Anti-Fog Eyepiece Ed (CAEPAFE3)

Designed for the EOS-3, the eyepiece prevents the fogging of the viewfinder lens in both extremely cold and hot climates. The anti-fog coating provides clear viewing under the severest conditions.....



39.95

#### Diopter Adjustment Lens E

(Without rubber frame for EOS-1v)



Provide near and far-sighted users a clear viewfinder image without their glasses. Available in ten types from +3 to -4 dpt to match your eyesight. (See below for ordering information).

Provide near and far-sighted users a clear viewfinder image without their glasses. Available in

#### Diopter Adjustment Lens Ed

(With rubber frame for EOS-3)

Provide near and far-sighted users a clear viewfinder image without their glasses. Available in eight types from +3 to -4 dpt to match your eyesight. (See below for ordering info).



### DIOPTRIC ADJUSTMENT LENSES

These Diopter Adjustment Lenses provide near and far-sighted users a clear viewfinder image without their glasses. Available in ten types from +3 to -4 dpt to match your eyesight. Each type fits into the eyepiece holders of the indicated EOS models for convenient use and comfortable fit.

#### ..... For EOS-1v .....

|                             |                          |
|-----------------------------|--------------------------|
| +2 Lens E (CADP2E) .....    | 0 Lens E (CAD0E) .....   |
| +1.5 Lens E (CADP1.5E)..... | -2 Lens E (CADM2E) ..... |
| +1 Lens E (CADP1E) .....    | -3 Lens E (CADM3E) ..... |
| +0.5 Lens E (CADP.5E).....  | -4 Lens E (CADM4E) ..... |

#### ..... For EOS-3, Elan 7N & Elan 7NE .....

|                                 |                                |
|---------------------------------|--------------------------------|
| +3 Lens Ed (CADP3EE7).....      | 0 Lens Ed (CAD0EE7) .....      |
| +2 Lens Ed (CADP2EE7).....      | -0.5 Lens Ed (CADM.5EE7) ..... |
| +1.5 Lens Ed (CADP1.5EE7) ..... | -2 Lens Ed (CADM2EE7).....     |
| +1 Lens Ed (CADP1EE7).....      | -3 Lens Ed (CADM3EE7).....     |
| +0.5 Lens Ed (CADP.5EE7) .....  | -4 Lens Ed (CADM4EE7).....     |

ORDER & INFO. (212) 502-6340 • FAX: (212) 239-7770 (800) 947-7008  
1-800-290-6750 • www.bhphotovideo.com



# CANON

## FLASHES & ACCESSORIES

### SPEEDLITE 220EX

Designed for automatic operation only, the 220EX features E-TTL evaluative pre-stored flash exposure control, FE Lock and FP Flash (High Speed Sync) for flash photography up to top shutter speed. When in E-TTL mode, flash exposure is measured and controlled by the camera. Subject position, ambient light level, evaluative metering and pre-flash data are instantly analyzed, including backlighting or reflections. Runs on 4 AA batteries (alkaline, lithium or nicad).



- ◆ Recycling Time: 0.1 to 4.5 sec.; Flash Capacity: 250 to 1700
- ◆ Flash Range: 2.3 ft./0.7m to 63 ft./22m (ISO 100)

Speedlite 220EX (CA220EX).....IMP. 114.95 / USA 119.95

### SPEEDLITE 420EX



Powerful yet affordable, the E-TTL compatible 420EX is designed to unlock your creative capabilities while still maintaining exceptional ease of use. It features a fully swiveling bounce head that automatically zooms over a range of 24-105mm, while wireless E-TTL compatibility permits it to function as a "slave" triggered by a 550EX; ST-E2, or MR-14EX/ MT-24EX.

- ◆ Guide Number 138 (ISO 100, feet) at 105mm; 101 at 35mm setting

- ◆ Approximately 1/2-stop less powerful than the 550EX
- ◆ Full E-TTL flash operation including high-speed FP sync mode, and FE Lock (spot / partial flash metering)
- ◆ Powered by 4 AA-size batteries (alkaline, lithium, nicad, NiMH)

Speedlite 420EX (CA420EX) .....IMP. 174.95 / USA 179.95

### SPEEDLITE 550EX

Used with your EOS camera, the 550EX—maximum GN 55/180, ISO 100m/ft.—offers full E-TTL operation including, FP Flash (high speed sync), FE lock (flash version of AE lock), and flash exposure bracketing. Modeling flash lets you check flash lighting effects (flash balance, shadows, etc.) A strobo flash with high frequency is also available for a greater percentage of successful shots.



Provides autozoom coverage from 24-105mm with a built-in 17mm wide panel, flash exposure compensation and variable-power manual flash. Built-in wireless transmitter (master unit) to control other 550EX and 420EX Speedlites as slaves for main, fill and background lighting. (Includes a mini-stand so it can be used as a slave unit). Runs on 4 AA batteries (alkaline, nicad or lithium), or with optional Canon power supplies.

Speedlite 550EX (CA550EX) .....IMP. 299.95 / USA 319.95

### MR-14EX MACRO RING LITE

Dramatically enhance your close-up and macro capabilities. It incorporates E-TTL autoflash control to achieve more natural flash pictures. In addition to Guide Number 14/46 (at ISO 100, m/ft.), photographers can take advantage of high-speed sync (FP flash), flash exposure lock (FEL), flash exposure bracketing (FEB), and variable power manual flash. Circular twin flash tubes can fire at even power, or varied between them over a six-stop range, and one or more 550EX Speedlites can be used as wireless slaves along with the MR-14EX.



#### MR-14EX and MT-24 EX Common Features

- ◆ Attach directly to EF 50mm f/2.5, 100mm f/2.8, and MP-E 65mm Macrophoto Lenses (can also be used with EF 180mm f/3.5L Macro USM via Macrolite Adapter 72C). Illuminated LCD panel for easy flash settings in any lighting condition.
- ◆ Incandescent focusing lamps and two forms of modeling flash permit preview of lighting effects.
- ◆ Powered by AA-size alkaline, lithium, nicad and NiMH batteries. They can also accept optional external battery packs (Canon Compact Battery Pack CP-E2 and Transistor Pack E).

### MT-24EX MACRO TWIN LITE

The MT-24EX Macro Twin Lite gives close-up, nature, and macro enthusiasts a different option in macro lighting—

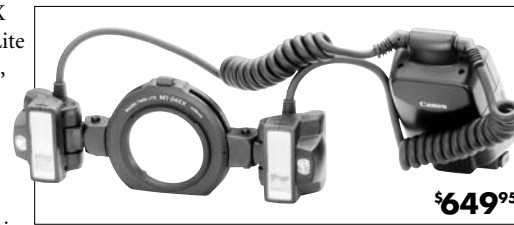

a directional quality of light, as opposed to the rather "flat" character of the traditional ring lite. Two separate flash heads can be swiveled around the lens, can be aimed separately, and even removed from their holder and mounted off-camera. The MT-24EX is fully E-TTL compatible with all EOS bodies and even allows wireless E-TTL flash control with one or more 550EX and/or 420EX "slave units". Provides easy ratio control of each flash head's output, over a six-stop range.

- ◆ Each head can be rotated around lens in an 80° arc, swiveled inward/outward over a 90° arc, and up/down over a 90° arc.
- ◆ Each head is removable, and has both a standard shoe-mount and 1/4-20 tripod socket at the base to facilitate mounting off-camera.
- ◆ Powerful guide number (72 ft/22m) allows smaller apertures and greater depth-of-field when necessary.

USA= Imported & Warrantied by Canon USA      IMP. = Imported & Warrantied by B&H (not qualified for Canon USA rebates and warranties)



For Any Inquiries Regarding Your Order, Call Our Customer Service:  
(800) 221-5743 • (212) 239-7765 • FAX: (800) 947-2215 • (212) 239-7549

# CANON

## FLASHES & ACCESSORIES

### SPEEDLITE 580EX

Canon's flagship Speedlite, the 580EX is smaller, lighter, faster and more powerful than the 550EX. A powerful flash with a maximum guide number of 191 at ISO 100 in feet (at 105mm), it offers 25% faster recycling, more consistent color, and enhanced controls that all photographers, especially those who shoot digital, will find useful.

It is compatible with Canon's E-TTL II auto exposure, which utilizes subject distance and other information to automatically modify flash power, when it is combined with a compatible Canon camera and lens. Ideal for photographers that shoot high contrast or reflective subjects, like those encountered in wedding photography.

For intuitive control, the 580EX's control dial, SET button and high-speed sync/shutter curtain synchronization button put all major functions at the photographer's fingertips. A new AF-assist beam is better matched to the different focusing point arrangements of various EOS SLRs.

Flash head swivels 180° in both directions, while a single release lock controls tilt and swivel adjustments. Wide-angle diffuser covers a 14mm focal length, and a catchlight reflector provides optimal lighting quality during bounce-flash photography. For convenience, 14 custom functions allow maximum control over various flash functions such as recycling with external power.

**Speedlite 580EX (CA580EX).....IMP. 379.95 / USA 389.95**



### Optional Battery Packs for Canon Speedlites



**CP-E3 Compact Battery Pack (CACPE3):** Accepts 8AA-size alkaline, nicad or lithium batteries (for all Speedlites except the 220EX) .....**139.95**

**Transistor Pack E (CATPE):** External Battery Pack for all Speedlites except the 220EX. Powered with the included Battery Magazine TP (which holds six C-size alkalines), or the optional rechargeable Nicad Pack TP. Includes Battery Magazine TP and Connecting Cord ET .....**141.95**

**Transistor Pack E NiCd Set (CATPENS):** Includes NiCd Pack TP, Nicad Charger TP and Connecting Cord ET (for all Speedlites except the 220EX) .....**249.95**

**NiCd Pack TP (CABPNT):** For Transistor Pack E. Requires NiCd Charger TP ...**109.95**

**NiCd Charger TP (CACTP):** For NiCd Pack TP. Charges in 15 hours .....**53.95**

**Battery Magazine TP (CABMTP):** Replacement battery insert for the Canon Transistor Pack E. Holds six C-size alkaline batteries .....**26.95**

### ST-E2 Speedlite Transmitter (CASTE2)

A master control device for a wireless Speedlite flash system, the ST-E2 eliminates the need for any connecting wires. Mounted as a clip-on with shoe lock lever and locking pin, the ST-E2's dedicated transmitter controls an unlimited number of 420EX or 550EX Speedlites as slave units up to 33' away outdoors and 49.5' outdoors.

Sets and controls all functions of its Speedlite slave units. Flash ratios, for example, are controllable between two groups of 420EX and/or 550EX Speedlites, over a six-stop range.....**209.95**



### Speedlite Cables & Adapters

**Off-Camera Shoe Cord 2 (CASC20C)**  
Allows you to use your Speedlite off camera (up to 2') while maintaining all on-camera flash functions .....**49.95**

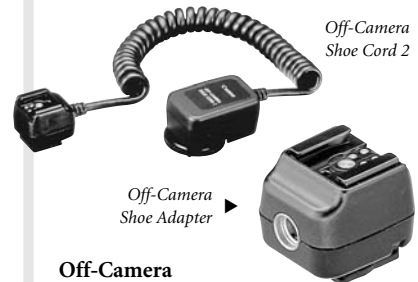

**Off-Camera Shoe Adapter (CAOCSAOA2)**  
For off-camera applications of Speedlite flash units, this adapter will accept one Speedlite and a connecting cord to the camera.....**29.95**

**Connecting Cord 60 (CACC60)**  
2' coiled cord, with connections on both ends.....**39.95**

**Connecting Cord 300 (CACC300)**  
9.8' straight cord, with connections on both ends.....**44.95**

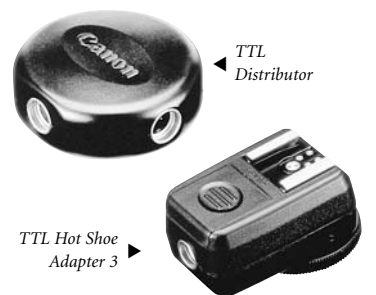

**TTL Hot Shoe Adapter 3 (CAHSA3TTL)**  
Placed in the EOS camera's accessory shoe, this device controls up to 4 off-camera speedlites.....**63.95**

**TTL Distributor (CADTTL)**  
System connector, accepts up to 4 connecting cords.....**47.95**

CAMERAS & LENSES

29

# CANON

## ACCESSORIES

### EX-Series Speedlite Lineup

|                             | Speedlite<br>580EX  | Speedlite<br>420EX  | Speedlite<br>220EX   | Macro Twin Lite<br>MT-24EX  | Macro Ring Lite<br>MR-14EX  |
|-----------------------------|---|---|--|---|---|
| Dimension (W x H x D)       | 2.99 x 5.28 x 4.49"   | 2.82 x 4.84 x 3.91"   | 2.7 x 3.62 x 2.42"   | Control Unit: 2.9 x 4.9 x 3.8"<br>Flash Unit: 9.3 x 3.5 x 1.9"  | Control Unit: 2.9 x 4.9 x 3.8"<br>Flash Unit: 9.3 x 3.5 x 1.9"  |
| Weight (without batteries)  | 13.2 oz.  | 10.6 oz.  | 5.6 oz.  | 20.64 oz. (flash & control unit)  | 15.1 oz. (flash & control unit)   |
| Compatibility               | All EOS SLRs  | All EOS SLRs  | All EOS SLRs   | All EOS SLRs  | All EOS SLRs  |
| Max. Guide Number (ISO 100) | 191'  | 138'  | 72.2'  | 79'   | 45.9'   |
| Power Source                | AA (Alkaline, re-chargeable nicad, Lithium, NiMH) batteries (x4); Compact Battery Pack CP-E3; Transistor Pack E | AA (Alkaline, re-chargeable nicad, Lithium, NiMH) batteries (x4); Compact Battery Pack CP-E3; Transistor Pack E | AA (Alkaline, re-chargeable nicad, Lithium, NiMH) batteries (x4) | AA (Alkaline, re-chargeable nicad, Lithium, NiMH) batteries (x4); Compact Battery Pack CP-E3; Transistor Pack E | AA (Alkaline, re-chargeable nicad, Lithium, NiMH) batteries (x4); Compact Battery Pack CP-E3; Transistor Pack E |

### REMOTE CONTROL ACCESSORIES

These accessories are handy for taking pictures of subjects that are difficult to approach, or to minimize vibration for close-ups and time exposure.

#### LC-4 Wireless Controller (CALC4S)

An infrared strobe-type wireless control system with a maximum range of 330' (several sets can be linked together for further extension.) There are 4 control modes: single exposure, continuous exposure, test and 3.5-second delay. A 2-stage switch enables individual control of metering and shutter release. Three transmitter channels are available, as well as an "All" position for operating several cameras from an individual transmitter via multiple receivers. The receiver features a signal confirmation light and a 1-step release mode for minimum time lag.....**409.95**



#### Remote Switch RS-80N3 (CARS80N3)

Remote switch with a 2.6' cord to prevent camera shake for super telephoto shots, macro photography, and bulb exposures. It works just like a shutter button, enabling halfway or complete pressing. It also has a shutter release lock. Quick-lock connects to the camera's remote control socket.....**49.95**

#### Timer Remote Controller TC-80N3 (CATC80N3)

Remote switch with a 2.6' cord, a self-timer, interval timer, long-exposure, and exposure-count setting feature. The timer can be set anywhere from 1 sec. to 99 hours, 59 min, 59 sec. A dial enables you to easily enter the numeric settings with a single thumb. The LCD panel can also be illuminated.....**132.95**



#### Extension Cord ET-1000N3 (CAET1000N3)

33' extension cord for connecting the camera with the TC-80N3 or RS-80N3.....**74.95**

#### Remote Switch 60-T3 (CARS60T3):

An electronic cable release handy for taking pictures of subjects that are difficult to approach, or to minimize vibration for close-ups and time exposure. Fitted with a 2' cord and 3-pin terminal for independent control of light metering and shutter release. (Requires Remote Switch Adapter RA-N3) .....**41.95**



Remote Switch 60-T3

**Remote Switch Adapter RA-N3 (CARAN3):** This adapter allows the Remote Switch 60-T3 to be used on the EOS-1v and EOS-3.....**43.95**

### DB-E2 Date Back

Designed exclusively for the Canon EOS-1v, EOS-1v HS and EOS-3, the Date Back DB-E2



offers a quartz auto date imprinting function. Interchangeable with the camera back, it is fitted with a standard back cover and functions with a Quick Control Dial and LCD display. Imprints dates to the year 2020 in five formats:

- Year/Month/Day
- Day/Hour/ Minute (with 24-hour display)
- Blank
- Month/Day/Year
- Day/Month/Year imprinting can be turned off at any time

**DB-E2 Date Back (CADBE2).....126.50**



### 4x and 8x Loupes

Designed for viewing 35mm film frames at high magnifications, these loupes use a high-performance lens system that eliminates all aberration and distortion. They offer diopter adjustment of -4 to +1 dpt, and include an eyecup, hood and case.

**4x Magnifying Viewer (CAL4X).....139.95**

**8x Magnifying Viewer (CAL8X).....159.95**



# CANON

## ACCESSORIES

### 2-Year Extended Warranty for EOS-1v, EOS-1v HS & EOS-3 (CAEWEIN)



This extended warranty covers an additional two (2) years of parts and labor service from date of purchase. Applies to Pro EOS camera bodies including the EOS-1V, EOS-1v HS and EOS-3.

The equipment will be guaranteed to operate properly according to manufacturer's specifications or will

be repaired to operate properly at no charge to you. This warranty does not cover equipment which has been misused, tampered with, modified or damaged as a result of accident, water, grit, impact or lack of proper care as indicated in the manual of operations. This limited warranty is non-transferable. This warranty must be purchased within 30 days of original equipment purchase.....**49.95**

### Camera Straps for EOS Cameras



**EW-100 Wide Camera Strap (CASWRE):** 1.5" wide strap designed to carry EOS or other cameras safely and comfortably. Features a built-in eyepiece cover for EOS SLR cameras. Red color.....**14.95**

**EW-100 Wide Camera Strap (CASWMBE):** Same as above in Marble and Blue .....**14.95**

**EW-100 Wide Camera Strap (CASWBE):** Same as above in Black .....**14.95**

**L3 Neck Strap for EOS Cameras (CASNL3):** For EOS cameras - especially EOS-1 and EOS-1v .....**22.50**

**Professional Strap 1 (CASPIB):** Rugged, high-quality neck strap featuring durable non-slip backing, quick-release clips and anti-twist hardware to make carrying and shooting with your camera hassle-free. Black color.....**12.49**



**Professional Strap 1 (CASPIGR)** Same as above in Green.....**12.95**

**E1 Hand Strap (CASHE1):** Designed for cameras that have a built-in power booster or grip, or where an optional power booster or extension grip has been added, the E1 Hand Strap adds security to hand-holding the camera. The strap attaches with one end to the eyelet at the top of the camera, and the other end to the eyelet in the base of the booster/grip .....**22.95**

**Black Wide Lens Strap (CASW).....29.95**

### Accessories

#### Deluxe Tripod 200 (CADT200)

This lightweight, high-quality tripod is designed for easy portability and maximum stability. It features a 3-way pan head for precise control and smooth movement. The 3-section tubular leg construction allows for exceptional stability indoors or out. The tripod also features a built-in spirit level and a quick-release shoe and comes with a convenient carrying case. The Deluxe Tripod 200 is 59.33" extended, 21.67" folded and weighs 2.65 lbs.....**39.95**



#### Mini Tripod 7 (CAMT7)

A tabletop tripod with ballhead that supports light SLR's or compact cameras. Legs extend approximately 8" .....**14.95**



#### Monopod 100 (CAMP100)

A lightweight, high-quality monopod featuring a deluxe 4-section compact tubular leg with quickside-lever leg locks and rubber tipped foot for added stability. The monopod 100 has a foam-covered handgrip, wrist strap and a ball socket head. It is 63" extended, 20.5" folded and weighs 16 oz.....**29.95**

#### S3 SLR Custom Accessory Pack (CAAKS3)

For EOS-1v and EOS-3. Includes a 58mm Haze UV filter, a Lens Care Kit, and a 2CR5 6v lithium battery .....**24.95**

#### S5 SLR Custom Accessory Pack (CAAKS5)

For EOS Rebel Ti and K2. Includes a 58mm Haze UV filter, a Lens Care Kit, and two CR2 3v lithium batteries .....**23.95**

#### S6 SLR Custom Accessory Pack (CAAKS6)

For Elan 7 / 7e, Rebel and G II. Includes a 58mm Haze UV filter, a Lens Care Kit, and two CR123A 3v lithium batteries .....**24.50**



#### CD Rom: The Eyes of EOS (CACDREE)

This CD covers EF lens basics and advanced technologies. It has images of EF lenses, and offers a lens glossary and technical information. Compatible with Macintosh OS 8.0 or later and Windows 95 or 98. ....**16.95**

#### R-F-3 Body Cap (CABCRF3)

For EOS bodies and extension tube fronts .....**6.95**



# CANON

## EF LENSES

*EF lenses fuse state-of-the-art electronics with mechanical precision, and optical excellence. The fully electronic EF lens mount is unique among 35mm SLR cameras, operating silently with unmatched reliability due to the complete elimination of mechanical couplings. Every EF lens contains its own custom-designed autofocus motor and microprocessor. Many utilize Canon's exclusive Ultrasonic Motor (USM) technology.*

*Canon is also a leader in the use of aspherical lens elements, fluorite crystal, Ultra-low dispersion (UD) glass and other advanced optical technologies. Uniformly high optical performance results from the extensive use of exclusive Canon-developed manufacturing techniques in Canon's own factories, the world's largest for 35mm cameras and lenses.*



### **Fully Electronic Mount System**

In designing the EF lens mount, Canon engineers gave a lot more than just a way to quickly attach a lens to a camera body. The fully electronic mount system has none of the shock, operational noise, abrasion, slow response or design restrictions related to linkage mechanisms used to transfer data. Instead, about 50 items of information are exchanged as digital signals between the lens and camera in real time. This enables high-speed and precision control as well as improved reliability.

- ◆ Quiet, high-speed, high-precision AF from fisheye to super telephoto since the optimum actuator can be incorporated into each lens.
- ◆ Quiet, high-precision aperture, or digital diaphragm control.
- ◆ Allows the aperture to be stopped down to pre-view depth of field and helps increase shooting speed by keeping the aperture stopped down during continuous shooting sequences.
- ◆ Permits fully automatic diaphragm control with Canon tilt-shift TS-E lenses.
- ◆ Using variable-aperture zoom lenses, any manually set f/stop (except for maximum aperture) is maintained throughout the zoom range.
- ◆ Automatic compensation and display of the change in the lens' effective F-number when an extender is mounted between lens and camera.
- ◆ Self-test system using the lens' built-in micro-computer warns of malfunctions through the camera's LCD to help ensure high reliability.

### **Inner and Rear Focusing**

An inner focusing lens has the focusing lens group(s) in front of the diaphragm, while a rear focusing lens has the focusing lens group(s) behind. Both systems allow the focusing lens group to be small. This minimizes the load on the actuator which drives the autofocus. In turn, the AF speed is faster. The whole optical system can also be made more compact. And, since the lens doesn't rotate during focusing, the effects of a circular polarizer or gel filter remain intact.

### **Floating System**

Ordinary lenses (non-zoom) are designed to give the best results when the correction of aberrations is most effective. This is usually at the most commonly-used focusing distances. At other focusing distances especially at the closest focusing distance, aberrations tend to appear. Canon's floating system suppresses aberrations at close focusing distances. The system adjusts the gap between certain lens elements in correspondence to the focusing distance, effectively correcting the aberration. The result is high image quality with aberrations suppressed at all focusing distances.

### **Built-In Motor and EMD**

EF lenses have a built-in AF motor for driving energy with lower transmission loss. The lenses also have an EMD (Electromagnetic Diaphragm) to electronically control the aperture with unmatched precision. The aperture can be set either with an electronic dial or with the electronic pulse signal sent according to the exposure reading.

### **Full-Time Manual Focusing**

EF lenses have very high AF precision, quickly achieving optimum focus in almost any shooting situation. Most are also equipped with Canon's full-time manual focusing mode to make picture-taking even more flexible. Lenses with this feature let you switch to manual while in AF mode—overriding the autofocus mode. You can keep looking through the viewfinder and touch up the focus manually without switching the focus mode switch. Two type of manual focusing: Electronic manual where the rotation amount of the focusing ring is detected and the focusing motor is driven electronically. Or, mechanical focusing, where the rotation of the focusing ring adjusts the focus mechanically.



For Any Inquiries Regarding Your Order, Call Our Customer Service:  
(800) 221-5743 • (212) 239-7765 • FAX: (800) 947-2215 • (212) 239-7549

# CANON

## EF LENSES

### Image Stabilizer

Canon has developed a series of truly unique lenses equipped with an Image Stabilizer (IS) function that let you capture photos that would otherwise be blurred due to camera movement, greatly expanding the range of handheld-camera photography.

To get sharp images when taking handheld pictures, the general rule of thumb is to set the shutter speed to 1/1 over the focal length, or the closest available setting on your camera. (i.e. 1/60 sec. with a 50mm lens, 1/250 sec. with a 200mm lens, 1/500 sec. with a 500mm lens and so on.) Generally, this is no problem, if all your pictures are taken outdoors on a bright, sunny day. But blurred pictures due to camera shake become more of a problem when taking pictures in dim light - at dusk, indoors, on a cloudy day. And the chance of getting blurred pictures is greater when using longer focal length lenses that magnify the image and any associated movement.

To overcome these problems, Canon developed the world's first SLR lens with a built-in image stabilizer. Electronic signals emitted by vibration-detecting gyro sensors are used to move the image-stabilizing lens group in parallel along the optical axis, providing clear picture quality at all times. Actual shooting tests result in improvement equivalent to using a shutter speed two steps faster.

In many shooting situations where photographers are not allowed to use a tripod or flash, such as art museums and concert halls, Canon IS lenses are your ticket to sharper pictures.

### Ultrasonic Motors (USM)

In order to achieve critical autofocus, the elements within a camera lens have to move quickly, quietly, and with exacting precision. To accomplish this, Canon developed the world's first lens-based Ultrasonic Motor (USM). Based on a totally new technology, the motor spins by ultrasonic oscillation energy. In effect, instead of a large, noisy drive-train system, electronic vibrations created by a piezoelectric ceramic element power the mechanical action of the lens. In a very broad comparison, it's like the difference between a mechanical watch with gears and springs and quartz-timed watch movement. Therefore, torque is constant and start and stop functions virtually instantaneous. By making the autofocus operation almost inaudible and by accelerating the autofocus speed, this type of motor greatly expands the shooting possibilities for Canon photographers. There is virtually no whining noise as the lens focuses to distract the subject or draw attention to the photographer. Most important for the photographer in the field, the motor draws minimal power so the camera batteries last longer.



Ring-Type USM



Micro USM

You'll find two types of Canon Ultrasonic Motors in the camera lens system, each optimized for maximum efficiency and effectiveness. Ring-type USM-equipped lenses, found in large aperture and super telephoto designs, allow manual focusing without switching out of the auto mode. It's a direct-drive system that provides all the above advantages. Micro USM designs bring the performance benefits of Canon's USM technology to a wide assortment of affordable EF lenses. Extremely compact and light, this USM is even used on lenses as small as the EF 28-90mm and EF 22-55mm.

Whenever you have an image in mind, you must choose a lens which can put that image on film. And whatever that image may be, you can be sure that Canon has the lens you need. Whether it is a 15mm fisheye or a 600mm super telephoto, all Canon lenses feature the finest materials (especially the L-series lenses) and technologies. They include fluorite, UD glass, aspherical lenses, lens-based Ultrasonic Motors, inner and rear focusing, Image Stabilizers, and a fully-electronic interface.

### L-Series Lenses

Canon lenses are renowned for their performance and optical quality. And no lenses have a better reputation among professional photographers than Canon's L-series lenses.

Identifiable by a distinctive red ring around their outer barrel, these lenses use special optical technologies including Ultra-low Dispersion UD glass, Super Low Dispersion glass, Fluorite and Aspherical elements to truly push the optical envelope.

L-series telephoto lenses utilize Canon's UD glass to minimize the effect of chromatic aberration, sometimes called color fringing. UD glass provides outstanding contrast and sharpness in lenses like the 70-200 f/2.8L IS and 300mm f/4.0L IS. Even more effective are fluorite elements, used in high-end super-telephoto lenses like the EF 300mm f/2.8L IS and 400mm f/2.8L IS. A single fluorite element has the corrective power of two UD glass elements, which gives these L-series lenses their spectacular performance.

Wide-angle lenses and fast normal focal-length lenses often suffer from another optical problem, spherical aberration, which causes an overall softening and optical "smearing" of the image. Canon has developed four different manufacturing technologies to produce Aspherical lens elements, which combat this problem. Aspherical optics, which have an extremely precise variable curvature of one or both sides of a lens element, also allow more compact lens designs and permit lighter lenses with fewer elements. Combined with Canon's exclusive multi-coating technology, Super Spectra Coating, and the attention paid to details such as anti-reflective material inside of lens barrels, L-series lenses virtually eliminate internal ghosting and flare. Many EF telephoto lenses are white, to reduce the amount of internal heat build-up during long shooting in bright sunlight. And the new Image Stabilized super-telephoto L-series lenses add extensive dust-and moisture-resistant seals and gaskets, enabling pros to keep shooting in the worst conditions.

Canon L-series EF lenses are designed and built to meet the needs of the most demanding professional photographers. Their superb optics enable pros and advanced amateurs to have lenses that are the absolute pinnacle of optical performance, and enable lens/speed combinations with professional performance simply not attainable using traditional optical technology.



# CANON

## EF LENSES

### FISHEYE and ULTRA WIDE ANGLE LENSES



EF 15mm  
f/2.8 Fisheye

#### EF 14mm f/2.8L USM (CA1428LEF)

This ultra-wide-angle lens has the shortest focal length in the L-series. Aspherical lens element corrects distortion and other aberrations such as stigmatism, resulting in ideal image quality. It's outstanding for shooting in confined areas and interiors. Floating rear focusing system makes auto-focusing faster, and the lens more compact. Full-time manual focusing lets you switch to manual focus even in AF mode. The lens also has a fixed petal-type hood and a gelatin filter holder at the rear. Includes soft case.....IMP. 1749.95 / USA 1789.95



EF 14mm  
f/2.8L USM

#### EF 15mm f/2.8 Fisheye (CA1528EF)

The 15mm f/2.8 is a fisheye lens with a 180° angle of view for unique and intriguing effects. The wide depth of field makes it even more interesting. The short minimum focusing distance of 0.7 ft. gives new meaning to close-up shots. The lens also has a fixed petal-type hood and a gelatin filter holder at the rear.....IMP. 559.95 / USA 579.95



EF 20mm f/2.8  
USM

#### EF 20mm f/2.8 USM (CA2028EF)

An ultra-wide angle lens for serious applications, the 20mm f/2.8 features a floating rear focusing system which allows the lens to made more compact (weighs only 14.3 oz.) and makes auto focusing faster. Full-time manual focusing lets you switch to manual focus even in AF mode. Filter size is 72mm.....IMP. 399.95 / USA 419.95

USA= Imported & Warrantied by Canon USA

IMP. = Imported & Warrantied by B&H (not qualified for Canon USA rebates and warranties)

### WIDE ANGLE LENSES

#### EF 24mm f/1.4L USM (CA2414LEF)

The EF 24mm f/1.4L USM is an indispensable tool for news photographers and photojournalists who require a fast, reliable and high-quality wide-angle lens. Equipped with spherical and Ultra-low Dispersion (UD) lens elements, the lens suppresses distortion and spherical aberrations while dramatically reducing lateral chromatic aberrations, for sharp pictures with accurate color reproduction. USM motor delivers high-speed, silent auto focusing with full-time manual override. Fixed front lens group means polarizing and special effect filters don't have to be adjusted after focusing. Includes LPL-1214 soft lens case and lens hood. Minimum focusing distance is 9.8". Filter size is 77mm.....IMP. 1089.95 / USA 1119.95



EF  
24mm  
f/1.4L USM



EF  
28mm f/1.8  
USM



EF  
24mm  
f/2.8



EF  
28mm  
f/2.8

#### EF 24mm f/2.8 (CA2428EF)

Popular wide-angle lens with a large aperture is good for casual snapshots as well as perspective shots. Floating rear focusing system corrects astigmatism and gives high contrast and sharp delineation. Filter size is 58mm.  
.....IMP. 279.95 / USA 289.95

#### EF 28mm f/1.8 USM (CA2818EF)

With it's large maximum aperture, excellent background blur is possible even with a fast shutter speed. An aspherical lens element makes the lens compact, while correcting for spheric aberrations. Full-time manual focusing lets you switch to manual even in AF mode. Filter size is 58mm.....IMP. 384.95 / USA 399.95

#### EF 28mm f/2.8 (CA2828EF)

The classic EF 28mm f/2.8 wide angle lens weighs only 6.5 oz. while offering a great price-to-performance ratio. High-precision aspherical lens minimizes distortion and other aberrations for sharp and high-contrast images. 52mm filter size.....IMP. 159.95 / USA 169.95



EQUIPMENT LEASING AVAILABLE

# CANON

## EF LENSES

### WIDE ANGLE and STANDARD LENSES



EF 35mm f/2

#### **EF 35mm f/2** (CA352EF)

Popular semi wide-angle lens with a large aperture features a minimum focusing distance of only 0.8', so you can approach the subject closer and still obtain a natural wide-angle effect. Also achieve good background blur for portraits. Filter size is 52mm.....IMP. 219.95 / USA 229.95



EF 35mm f/1.4L USM

#### **EF 35mm f/1.4L USM** (CA3514LEF)

This lens features a brilliant maximum aperture of f/1.4, the largest in its class, along with the superior image quality Canon L-series lenses deliver. It uses Canon's advanced floating mechanism and a polished aspherical lens element to achieve extremely sharp, distortion free, superb picture quality from infinity to its closest shooting distance of 12". With ring USM-powered rear focus, autofocus is fast and quiet. Full-time manual focusing lets you switch to manual in AF mode. Wide focusing ring provides comfortable manual focus, and the filter ring remains stationary while using a polarizer. Includes LP1214 soft lens case and EW-78C lens hood. Filter size is 72mm.....IMP. 1089.95 / USA 1119.95



EF 50mm f/1.8 II

#### **EF 50mm f/1.8 II** (CA50182EF)

Lightweight and affordable, this 4.6 oz. sharp lens with a fast f/1.8 aperture is an excellent first lens for those who prefer a fixed focal length, and makes an excellent addition to any photographer's system for available-light shooting. A traditional Gauss-type optical design ensures sharp performance even wide open, and it focuses as close as 18". Filter size is 52mm .....IMP. 69.95 / USA 74.95

#### **EF 50mm f/1.4 USM** (CA5014EF)

The ultimate "normal" lens in the EF system. This superb lens is sharp even wide-open, and of course its f/1.4 speed makes it perfect for available-light shooting. For many, it's an ideal lens to accompany a zoom when shooting in low-light conditions. Compact and affordable, it's the only lens in the EF system to combine the extra-small Micro USM and still provide full-time manual focusing when the lens is in the AF mode. 58mm filter size..... IMP.299.95 / USA 309.95

USA= Imported & Warrantied by Canon USA

IMP. = Imported & Warrantied by B&H (not qualified for Canon USA rebates and warranties)

### Standard Lenses

*With a natural angle of view and perspective, standard lenses capture the subject plainly, with no special effects. The result is different from a wide-angle or telephoto lens which is used for more expressive purposes. At the same time however, you can use standard lenses in creative ways by varying the subject distance, aperture, and angle. Canon offers two standard EF lenses each with a different maximum aperture.*

### Portrait and Medium Telephoto Lenses

*A medium telephoto lens with a large aperture brings the subject closer, creates excellent background blur, gives a longer flash range, and affords a faster shutter speed to freeze the action. Best of all, they aren't too heavy to carry around—even on a ski slope.*

### Telephoto Lenses

*A telephoto lens is essential to any serious photographer. For sports action, you will need a fast shutter speed and a long focal length. A large maximum aperture allows a faster shutter speed. If you want a smaller more compact lens, choose a lens with a smaller maximum aperture.*

ORDER & INFO. (212) 502-6340 • FAX: (212) 239-7770 (800) 947-7008  
1-800-290-6750 • [www.bhphotovideo.com](http://www.bhphotovideo.com)



# CANON

## EF LENSES

### PORTRAIT and MEDIUM TELEPHOTO LENSES



EF 85mm  
f/1.8 USM

#### **EF 85mm f/1.2L USM** (CA8512LEF)

With a large maximum aperture of f/1.2, this is the fastest 85mm lens in its class. Has one aspherical element and two high-refraction elements to produce sharp images with little flare, even at maximum aperture. Floating system corrects coma for high image quality. Full-time manual focusing lets you switch to manual even in AF mode. Includes LP-1219 lens pouch and ES-79II lens hood. Filter size is 72mm.....IMP. 1449.95 / USA 1499.95



EF 100mm  
f/2 USM

#### **EF 85mm f/1.8 USM** (CA8518EF)

A very practical medium telephoto lens with superb delineation and portability, this lens produces images that are sharp and clear at all apertures. Specially designed to give beautiful background blur. Full-time manual focusing. Filter size is 58mm ...IMP. 329.95 / USA 339.95

#### **EF 100mm f/2 USM** (CA1002EF)

An extremely compact lens despite its large maximum aperture. Floating rear focusing system makes autofocus faster and helps achieve sharp, crisp pictures at all apertures. Provides a background blur that is ideal for portraits. 58mm filter size.....IMP. 374.95 / USA 389.95

USA= Imported & Warrantied by Canon USA

IMP. = Imported & Warrantied by B&H (not qualified for Canon USA rebates and warranties)

### TELEPHOTO LENSES

#### **EF 135mm f/2L USM** (CA1352LEF)

The fastest telephoto in its class, this lens provides the image quality and performance required to meet the needs of a wide range of advanced amateurs and professionals. A ten element optical formula with two UD-glass elements serves to correct residual aberrations, resulting in superb sharpness and high image quality. Ideal for indoor sports and portraits, it is also able to obtain superior background blur with the f/2 wide aperture. Includes LP1219 lens case and ET-78II lens hood. Filter size is 72mm .....IMP. 869.95 / USA 899.95

#### **EF 135mm f/2.8 Softfocus** (CA13528EF)

A telephoto lens with softfocus capability, this lens can give you razor-sharp snapshots as well as softfocus shots that do not look blurry. Offers a choice of two softfocus settings. Even in softfocus mode, autofocus is quick and accurate. 52mm filter size .....IMP. 269.95 / USA 279.95



EF 200mm  
f/2.8L II  
USM

EF 135mm  
f/2.0L USM

EF 135mm f/2.8 Softfocus

#### **EF 200mm f/2.8L II USM** (CA20028L2EF)

Built on the success of its predecessor; the EF 200mm f/2.8L version "II" employs Canon's famous rear-focus telephoto optical design to deliver outstanding picture quality throughout its entire shooting range - even at middle and close distances. This lens also uses two ultra-low dispersion (UD) glass elements to ensure maximum image sharpness and accurate color fidelity; and Canon's advanced ultrasonic focusing motor (USM) and rear focusing design for silent, high speed autofocus. Smooth manual focusing is accomplished through Canon's mechanical manual focusing system and wide rubber focusing ring for easy adjustments. Full-time manual focusing lets you switch to manual even in AF mode. Compatible with 1.4x and 2x EF extenders. Includes LP1222 lens case and ET-83BII lens hood. Filter size is 72mm .....IMP.639.95 / USA 659.95



**ONE HOUR FREE PARKING**  
AT 349 W. 34th STREET (with purchase of \$100 or more)



# CANON

## EF LENSES

### SUPER TELEPHOTO LENSES

*With the ability to see surpassing the human eye, a super telephoto lens has the ability to transform an ordinary scene into an extraordinary one. It can compress images and make them look as if they come from another dimension. It opens up new realms of photographic expression. All Canon EF super telephoto lenses are L-series to provide the highest quality, while the USM delivers quiet and high-speed autofocus.*



EF 600mm f/4L IS USM

- ◆ All except the 300/4L and 400/5.6L feature Focus Preset (FP). With FP you can set the desired focusing distance in memory and later instantly focus the lens at that distance. Normal shooting and focusing is possible while FP has been set.
- ◆ All except the 300/4L and 400/5.6L are highly resistant to dust and water. Their switch panel, exterior seams, and drop-in filter compartments have rubber linings.
- ◆ All (except 400/5.6L) have a built-in Image Stabilizer because no matter how great the lens is, camera shake can spoil the shot. Optical shake is detected by gyro sensors which provide the data necessary to shift the image-stabilizing lens group in parallel to neutralize the shake. This increases usable shutter speed range by up to two full stops for hand-held shooting. There are two IS modes: one for normal image stabilization, one for panned shots.
- ◆ All except the 300/4L and 400/5.6L feature a fluorite lens element to correct chromatic aberrations. Fluorite has abnormally low refraction and low dispersion characteristics which optical glass can't achieve.
- ◆ In addition to fluorite, they each incorporate two UD (Ultra-Low Dispersion) glass elements whose properties nearly match those of fluorite (the effect of two UD-glass elements is equivalent to one fluorite). The 400/5.6L has a Super UD-glass element which gives almost the same effect as one fluorite element.
- ◆ All except the 300/4L and 400/5.6L have an 'AF Stop' feature. If something passes between the camera and subject, the AF-Stop button momentarily locks the AF to prevent the focus from shifting to the obstruction passing by. After it is gone, the focus is maintained so you can quickly resume shooting.

#### **EF 300mm f/2.8L IS USM (CA30028LISEF)**

Lightweight with superb balance, this lens is the standard for performance and versatility. The lens barrel is made of magnesium alloy construction for reduced weight and improved handling. The rotating tripod collar can be removed for even more weight reduction. Includes lens case and ET-120 lens hood. Filter size is 52mm (drop-in).....Call

#### **EF 300mm f/4L IS USM (CA3004LISEF)**

Large f4 aperture makes this lens a great value. All the features of the EF 300mm f/2.8L except fluorite lens element, AF Stop and Focus Preset. Includes case, has built-in hood. 77mm filter size .....1149.95

#### **EF 400mm f/5.6L USM (CA40056LEF)**

High-performance lens designed for portability and handling. Has a detachable tripod mount. Includes case, has built-in hood. 77mm filter size .....1099.95



EF 300mm f/4L IS USM

#### **EF 400mm f/2.8L IS USM (CA40028LISE)**

The standard for professional sports, it is also ideal for low-light nature and wildlife photography. Full-time mechanical manual focus, four AF-Stop buttons, and Focus Pre-set controls. Includes lens case and ET-155 lens hood. Filter size is 52mm (drop-in).....Call

#### **EF 500mm f/4L IS USM (CA5004LEF)**

Favorite of motor sports, wildlife and nature shooters. Well balanced - less "front heavy" - for superior handling. Durable, magnesium alloy construction, with improved control layout. Includes lens case and ET-138 lens hood. Filter size is 52mm (drop-in).....Call

#### **EF 600mm f/4L IS USM (CA6004LISEF)**

The first 600mm lens with an Image Stabilizer. Same weather-resistant design as the 300, 400 and 500mm as well as their less "front-heavy" design, and mechanical manual focus. Includes lens case and ET-160 lens hood. Filter size is 52mm (drop-in).....Call

# CANON

## EF LENSES



### **EF 400mm f/4L DO IS USM** (CA4004ISEF)

Equipped with Canon's breakthrough diffractive optics (DO) lens technology, the 400mm f/4 DO is significantly shorter and lighter than previously possible, while simultaneously improving performance by reducing chromatic aberrations and spherical aberrations. Fast AF and full-time mechanical focus and dust and water-resistant construction. Includes lens case and ET-120 lens hood. Filter size is 52mm (drop-in) .....5299.95

**Understanding Diffractive Optics:** Glass lens elements refract, or bend lightwaves as they pass through it to form an image. Canon uses multiple elements and special glass to keep the lightwaves like a pinpoint instead of spreading them into the rainbow of color you see when light passes through a prism. To diffract lightwaves means that the ray goes through a change in direction before passing through the lens. The change in direction is caused by a diffraction grating — very fine parallel grooves or slits on the surface. Canon uses two single-layer diffractive optical elements whose diffraction gratings are bonded together face-to-face. The diffraction that occurs with Multi-Layer Diffractive optical elements actually corrects the optical system's chromatic aberrations and improve the image formation performance. Why is Canon changing the tried and true physics of lens design? In terms of design and manufacture, it allows them to create lenses that are shorter and lighter than comparable refractive optical systems. The 400mm f/4 DO IS USM lens is approximately 27-percent shorter and 36-percent lighter in weight than a conventional 400mm f/4 telephoto lens would be. Image quality of Canon's DO lenses are comparable to the L-Series, offering photographers very high performance.

USA= Imported & Warrantied by Canon USA

IMP. = Imported & Warrantied by B&H (not qualified for Canon USA rebates and warranties)

## TILT & SHIFT LENSES

*With a Canon TS-E lens, you can control the angle of the plane of focus and the picture's perspective. The effects of large-format camera movements can be obtained with TS-E lenses for EOS cameras. Although manual focusing is required, automatic aperture control enables auto exposure and auto exposure bracketing. The tilt and shift axes intersect at a 90° angle. With their tilt and shift movements, these lenses further expand photographic possibilities. Tilt movements alter the angle of the plane of focus between the lens and film plane, allowing you to obtain a wide depth of field even at the maximum aperture and still keep the entire subject in focus. Shift movements move the lens' optical axis in parallel, correcting the trapezoidal effect seen in pictures taken of tall objects such as buildings, so that the subject does not look distorted.*

**Tilt Movements:** If you want to bring the entire length of the hedge into focus, you could use a wide-angle lens and a small aperture to obtain a wide depth of field. With tilt movements, you can achieve this wide depth of field even at the maximum aperture. By tilting the center of the TS-E lens barrel, you can tilt the lens so that the plane of focus is uniform on the film plane.

**TS-E 24mm f/3.5L** (CA2435TSE): Great for architecture, landscapes and other wide-angle shots. Includes LP1216 soft case and EW-75BII lens hood. Filter size is 72mm IMP. 1069.95 / USA 1099.95

**Shift Movements:** Normally, when you point your camera up at a tall building, the building will look slimmer toward the top. It becomes trapezoidal. This perspective effect is more pronounced with shorter lens focal lengths, distorting the building even more. By altering the parallel position between the lens and the film plane with the TS-E lens, this perspective effect can be corrected. With the camera's film plane set parallel to the building, shifting the lens upward will obtain a more rectangular-looking building.

**TS-E 45mm f/2.8** (CA4528TSE): Ideal for obtaining a natural-looking perspective. Includes LP1216 soft lens case and EW-79BII lens hood. Filter size is 72mm .....IMP. 1069.95 / USA 1099.95

**S-E 90mm f/2.8** (CA9028TSE): Ideal for a variety of subjects, from products to portraits. Includes LP1016 soft lens case and ES-65II lens hood. Filter size is 58mm .....IMP. 1069.95 / USA 1099.95



TS-E 24mm f/3.5L lens



TS-E 90mm f/2.8 lens



**EQUIPMENT LEASING AVAILABLE**

# CANON

## EF LENSES

CAMERAS & LENSES

39

### TELE EXTENDERS



#### Extender EF 1.4x & Extender EF 2x

These high performance lens extenders increase the focal length of telephoto lenses by 1.4x (EF 1.4x) or 2x (EF 2x). They can be used with a 135mm or longer fixed-length lens, or with the EF 70-210/2.8L, 70-210/4L and the EF 100-400L. Attaching the 1.4x decreases the f-stop by one stop, attaching the 2x by two stops. With the 1.4x, autofocus is possible with an f/4 maximum aperture or better. With the 2x, autofocus is possible with an f/2.8 or better. The lenses are weather-resistant on the front and rear mount surfaces to match the level provided by the IS super-telephoto lenses. They also offer internal anti-reflection construction that improves contrast even when shooting in heavy backlit conditions.

- Extender EF 1.4XII (CA1.4XE2) .....IMP. 269.95 / USA 279.95
- Extender EF 2XII (CA2XE2) .....IMP. 269.95 / USA 279.95

### MACRO LENSES

The small things we see and ignore everyday can actually reveal much surprise and fascination up close. Canon's macro lenses—three autofocus and one manual – are the most versatile way to discover this world.

#### EF 50mm f/2.5 Macro (CA5025MEF)

Floating system for superior delineation at all focusing distances (1:1 reproduction ratio with optional Life Size Converter EF). With a large f/2.5 aperture, true and beautiful background blur is possible. A multi-purpose lens for portraits and other applications besides macro photography. Filter size is 52mm .....IMP. 229.95 / USA 239.95



EF 50mm f/2.5 Macro



EF 180mm f/3.5L Macro USM

#### MP-E 65mm f/2.8 1-5x Macro Photo (CA6528MP)

While not an EF lens, this manual focusing macro photo lens designed to achieve a high magnification greater than 1x (1:1 reproduction ratio) without any additional accessories. Ideal for shooting small objects, the lens' optical formula and UD-glass elements suppress chromatic aberrations which become apparent at high magnifications. For flash photography, the the ML-3 or MR-14EX Macro Ring Lite can be attached to the lens. Includes a tripod mounting ring. Filter size is 58mm .....IMP. 799.95 / USA 829.95

#### EF 100mm f/2.8 Macro USM (CA10028MEFQ)

Designed for macro photography up to life-size (1:1) magnification, this autofocus lens is the first in its class to feature inner focusing - its length never changes, even at life size. The 3-group floating system provides exceptional close-up performance and delineation at all focusing distances. Ring type USM provides fast and silent AF throughout its focus range, and allows full-time manual focusing - permitting the close-up or macro shooter to instantly override the AF whenever necessary. Connects directly to the ML-3 and MR-14EX Macro Ring Lites. Filter size is 58mm .....IMP. 449.95 / USA 469.95

#### EF 180mm f/3.5L Macro USM (CA18035MLEF)

With a maximum magnification of 1x, the EF 180mm f/3.5L can shoot life-size close-ups from a farther distance without disturbing the subject. Internal floating system with three UD-glass elements minimize fluctuations in aberrations caused by changes in the focusing distance - delineation is razor-sharp from 1x to infinity. Operability is further enhanced through a wide manual focus ring. Another advantage of this lens is its internal focusing, so lens length doesn't change and the front element doesn't rotate. Supplied with LZ1324 case and ET-78II lens hood. Filter size is 72mm.....IMP. 1199.95 / USA 1239.95



MP-E 65mm f/2.8 1-5x Macro Photo

USA= Imported & Warrantied by Canon USA

IMP. = Imported & Warrantied by B&H (not qualified for Canon USA rebates and warranties)

ORDER & INFO. (212) 502-6340 • FAX: (212) 239-7770 (800) 947-7008  
1-800-290-6750 • www.bhphotovideo.com



# CANON

## EF LENSES

CAMERAS & LENSES

40

### ULTRA WIDE ANGLE ZOOM LENSES



EF  
16-35mm  
f/2.8L USM

#### **EF 16-35mm f/2.8L USM** (CA163528LEF)

To meet the growing demand of digital SLR owners, this ultra-wide-angle zoom offers a broader view, fast aperture, and closer focusing down to 11". The first EF wide-angle zoom to combine three aspherical elements and Canon's UD glass, the lens remains compact while providing superior image quality across its range. Constructed to pro standards, it's also highly resistant to dust and moisture. Includes LP1319 pouch and EW-83E lens hood. Filter size is 77mm.....**IMP. 1359.95 / USA 1399.95**



EF  
17-40mm  
f/4L USM

#### **EF 17-40mm f/4L USM** (CA17404LEF)

The optics on this lens are excellent, highlighted by three Aspherical lens elements, and one Super UD (Ultra-Low Dispersion) glass element. It features a constant f/4 maximum aperture, moisture- and dust-resistant construction, and a high-speed AF with a powerful ring-type USM. Includes LP1319 soft lens case and EW-83E lens hood. Filter size is 77mm .....**679.95**

#### **EF 20-35mm f/3.5-4.5 USM** (CA203535EF)

Offering high optical performance, the lightweight (only 12 oz.) EF 20-35mm f/3.5-4.5 USM is a very portable and practical ultra-wide angle lens. Large front lens group minimizes peripheral darkening; flare-blocking diaphragm minimizes flare. Filter size is 77mm .....**IMP. 349.95 / USA 369.95**

USA= Imported & Warrantied by Canon USA

IMP. = Imported & Warrantied by B&H (not qualified for Canon USA rebates and warranties)

### WIDE ANGLE ZOOM LENSES

#### **EF 24-70mm f/2.8L USM** (CA247028LEF)

A superb new lens that offers a wider zoom range than its predecessor. It features 2 types of aspherical elements, and a new UD-glass element for superb optical performance even wide-open. It focuses closer and faster with a new processor. And, it's now sealed against dust and moisture at the lens mount, the zoom and focus rings, and the switch plate. Includes LP1219 soft lens case and EW-83F lens hood. Filter size is 77mm .....**1149.95**

#### **EF 24-85mm f/3.5-4.5 USM** (CA248535EF)

Compact, powerful and lightweight, this lens offers 3.5x magnification with minimum focus to 1.6'. USM motor and internal focusing enable silent, high speed autofocus. Wide rubber focus ring and manual focus capability - even in autofocus - provide maximum flexibility and ease of use. Replica aspherical lens element minimizes distortion and produces sharp images. Flare-cutting diaphragm maintain high contrast even in tough lighting conditions. Filter size is 67mm.....**IMP. 299.95 / USA 309.95**

#### **EF 28-80mm f/3.5-5.6 II** (CA2880352EF)

Standard zoom lens with the same optical system, construction, and exterior as the EF 28-80mm f/3.5-5.6 USM. The difference is that it uses a DC motor instead of a USM to drive the AF. Filter size is 58mm .....**Call**

#### **EF 28-90mm f/4-5.6 III** (CA28904EF2)

A revised version of one of Canon's most popular lenses. Optically identical to its predecessor, a new lens CPU and data algorithm provide the fastest AF in its class. Filter size is 58mm .....**IMP. 89.95 / USA 99.95**



EF 24-70mm f/2.8L USM



EF 28-90mm f/4-5.6 III



For Any Inquiries Regarding Your Order, Call Our Customer Service:  
(800) 221-5743 • (212) 239-7765 • FAX: (800) 947-2215 • (212) 239-7549

# CANON

## EF LENSES

CAMERAS & LENSES

41

### Description of Lens Designation

The lens designations follow a standard format to identify the lens:

### EF 75-300mm f/4-5.6 IS USM

#### Focal length:

Indicates the focal length range from the shortest to the longest length

#### Maximum Aperture:

Indicates the lens' maximum aperture

#### Special Function:

Any special feature such as an image stabilizer, macro feature, etc., is indicated

#### USM:

Indicates that the lens uses an Ultrasonic Motor for autofocus

### WIDE ANGLE ZOOM LENSES

#### EF 28-90mm f/4-5.6 II USM (CA28904EF2)

Super-light and compact like its predecessor, but now with even faster AF due to a faster lens CPU. It's optically unchanged, which is a good thing—images are sharp and crisp throughout the zoom range, and the Micro USM provides quick and ultra-quiet AF. It's an ideal standard lens, and one of the most popular in the entire EOS system. Available in black or silver. Filter size is 58mm.....IMP. 99.95 / USA 109.95

#### EF 28-105mm f/3.5-4.5 II USM (CA28105352EF)

Excellent for everyday use, the lens includes a ring-type USM drive for silent, high-speed autofocus, plus full-time manual focus. Optically excellent, the lens delivers high image quality at all focal lengths. Wide zoom ring provides more positive operation. The compact design is a good match for the ELAN 7N/7Ne with built-in flash. An excellent zoom lens for everyday use. Filter size is 58mm.....IMP. 219.95 / USA 229.95

#### EF 28-105mm f/4-5.6 USM (CA28105456U)

An entirely new lens which joins Canon's existing 28-105 f/3.5-4.5 USM in the line-up. It's the smallest and lightest zoom in the 28-105 class, and its new optical system includes an Aspherical element. Most noteworthy is its new Micro USM II — half the size of previous Micro USMs, and its use of internal focusing (no front element rotation during focus). Filter size is 58mm .....IMP. 129.95 / USA 139.95

#### EF 28-135mm f/3.5-5.6 IS USM (CA2813535EF)

High performance lens with built-in image stabilizer (IS) for shooting everything from tight interiors to sports to portraits. With the stabilizer on you can shoot sharp, natural-looking pictures in dim lighting without a flash or tripod. Choosing slower speeds also allows use of smaller apertures for increased depth-of-field. Pulse control Electromagnetic Diaphragm (EMD) provides quick and accurate aperture control. Ring-type USM for fast, quiet autofocus. Aspherical lens element for edge to edge sharpness. Close focusing to 20". Filter size is 72mm .....IMP. 394.95 / USA 409.95

#### EF 28-200mm f/3.5-5.6 USM (CA2820035EF)

The highest optical performance in its class, this lens offers the convenience of focusing to 17.7" over the entire zoom range. 16-element design includes two aspherical elements. Micro USM drive provides silent, high-speed AF Inner focusing means the front doesn't rotate, a benefit when using filters. Filter size is 72mm .....IMP. 339.95 / USA 359.95

EF 28-90mm f/4-5.6 II USM

EF 28-105mm f/3.5-4.5 II USM

EF 28-105mm f/4-5.6 USM

EF 28-135mm f/3.5-5.6 IS USM

EF 28-200mm f/3.5-5.6 USM

USA= Imported & Warrantied by Canon USA

IMP. = Imported & Warrantied by B&H (not qualified for Canon USA rebates and warranties)

ORDER & INFO. (212) 502-6340 • FAX: (212) 239-7770 (800) 947-7008  
1-800-290-6750 • www.bhphotovideo.com



# CANON

## EF LENSES

### HIGH-POWER WIDE ANGLE ZOOM LENSES

#### **EF 28-300mm f/3.5-5.6L IS USM (CA2830035IS)**

Offering incredible 11x zoom capability, the EF28-300mm f/3.5-5.6L IS USM combines Canon's latest optical glass, faster autofocus and a groundbreaking Image Stabilization system—so capturing incredible images is a snap—even when the zoom is at max, the shutter speed is slow and the camera is handheld. This 22-element L-series design lens features three ultra low dispersion (UD) glass elements that reduce chromatic aberration, and three aspherical elements that reduce linear distortion and correct spherical aberration during zooming (keeping image resolution and contrast high), together with superior lens coatings that minimize reflection. Highly refined Image Stabilization (IS) system with shake-detecting gyro sensors corrects up to three shutter speed steps for handheld photography. Additionally, IS remains effective even when using a tripod, improving image quality by eliminating the effects of reflex mirror vibration at slow shutter speeds. IS mode switches allow you to select for general stabilization or for deliberate panning. IS is activated within 0.5 seconds of depressing the shutter halfway. Additionally, the lens features a powerful, quick and silent ring-type Ultrasonic Motor and an inner focus system that moves only the lens' lighter elements during AF while keeping the front elements stationary.

Because of its extended range, the lens features a push-pull zoom, though it does have a zoom adjustment ring that lets you loosen, tighten or lock the zoom control. It also permits close minimum focus from 2.3' at all focal lengths, and is capable of filling the frame with a subject as small as 3.2 x 4.8" at the 300mm setting. The lens includes EW-83G bayonet mount lens hood, detachable tripod collar and soft lens case. Filter size is 77mm .....2199.00



#### **Photo Tip From Rick Sammon:**

We all love to travel, and we want to come back from our vacations with great travel pictures. Our travel agents and on-site guides can help us maximize our time - seeing what we want to see. But it's up to us to maximize our photo opportunities. Perhaps the most important photo tip for travel photographers is this: "Tell the whole story." In other words, take pictures that "create a sense of place." "Telling the story" does not necessarily require packing "tons" of lenses and accessories, which could actually slow you down when you are on

the move. Rather, it's important to choose your travel gear wisely (especially with today's airline restrictions on carry-on bags). Zoom lenses are great for travelers. Pack a standard or wide-angle zoom for street scenes and landscapes, and a telephoto zoom for people pictures, and you'll come back with a good selection of pictures. For low light shooting indoors (museums, churches, interiors of buildings), you want a "fast" (f/2.8) lens, which lets you shoot at a higher shutter speed than an f/4.5-5.6 lens.

### STANDARD ZOOM LENSES



EF 35-80mm  
f/4-5.6 III

#### **EF 35-80mm f/4-5.6 III (CA358043EF)**

At 6.2 oz. this is the lightest compact zoom EF lens. An excellent value, the aspherical element makes it compact and helps obtain high-contrast images. At the 80mm focal length, a postcard can fill the viewfinder frame. Filter size is 52mm .....IMP. 74.90 / USA 79.95

#### **EF 55-200mm f/4.5-5.6 II USM (CA5520045EF2)**

Super-compact and light, this lens is compatible with all EOS cameras. Features a 13-element design and new optical coatings. It focuses down to under 4' and its Micro USM-powered AF is faster than ever, due to new electronics within the lens. Filter size is 52mm.....IMP. 199.95 / USA 209.95



USA= Imported & Warrantied by Canon USA

IMP. = Imported & Warrantied by B&H (not qualified for Canon USA rebates and warranties)



# CANON

## EF LENSES

### TELEPHOTO ZOOM LENSES

#### **EF 70-200mm f/2.8L USM** (CA7020028LEF)

One of the best telephoto zoom lenses ever made by Canon, the EF 70-200mm f/2.8L has four UD-glass elements (the equivalent of two fluorite elements) to correct chromatic aberrations. Newly-designed multiple zoom groups for inner focusing bring high image quality throughout the entire zooming range. Full-time manual focusing mode lets you switch to manual focus even in AF mode. Includes ET-83II lens hood and LZ1324 soft lens case. Filter size is 77mm.....IMP. 1099.95 / USA 1139.95



#### **EF 70-200mm f/2.8L IS USM** (CA7020028LIS)

Entirely new, this sensational lens brings an unprecedented combination of features and performance to professional and serious amateur photographers. A new "second-generation" Image Stabilization system responds in only 0.5 seconds, and provides up to three stops of correction for camera shake. Its minimum focusing distance, AF speed, and weather resistance surpass the previous EF 70-200mm f/2.8L. Includes ET-86 lens hood and LZ1324 soft case. Filter size is 77mm .....IMP. 1639.95 / USA 1699.95



#### **EF 70-200mm f/4L USM** (CA702004LEF)

This lightweight high-performance zoom lens features fluorite and UD glass to eliminate chromatic aberration. A circular polarizer can be used because the front lens element doesn't rotate during focusing. Full-time manual focusing mode lets you switch to manual even in AF mode. Inner focusing, and ring-type USM for quick and quiet autofocus. An optional tripod collar is also available. Includes ET-74 lens hood and LP1224 soft lens case. Filter size is 67mm.....579.95

#### **EF 75-300mm f/4-5.6 III** (CA7530043EFQ)

The optical system, construction, and exterior are the same as the EF 75-300 mm f/4-5.6 III USM (next page). Difference is that it uses a DC motor instead of a USM to drive the AF. 58mm filter ...IMP. 149.95 / USA 159.95

#### **EF 70-300mm f/4.5-5.6 DO IS USM** (CA7030045IS)

Compact, without compromising any image quality, the EF70-300mm f/4.5-5.6 DO IS USM is the second EF lens to employ Diffractive Optics (DO) technology. Indeed, it's three-layer diffractive element is far better suited to zoom lenses and improves on the two-layer DO element used in the EF400mm f/4 DO IS USM lens. Significantly smaller and lighter than conventional 70-300mm lenses, this zoom is approximately the length and diameter of the 28-135mm IS lens.

Equipped with image stabilization technology, the lens provides up to three stops of effective shake reduction capability, equivalent to shooting handheld at 1/30 with the stability found on conventional lenses at 1/250. It also offers a choice of general stabilization and deliberate panning. The IS system remains functional when the lens is used on a solid tripod, although handheld usage is the norm thanks to its compact size. Compact, shake detection gyro sensors for smoother control of IS optics, and compact zoom locking mechanism (locks the lens at its smallest 70mm setting and prevents lens "creeping" while camera is carried on a neck strap) also contribute to the lens' smaller, more comfortable size.

Incorporates a larger, ring type Ultrasonic Motor that provides more power and torque than the smaller Micro USM for faster autofocusing than equivalent lenses. In addition, a rear-group AF system moves the lighter and smaller lens elements at the rear of the lens for focus, keeping the larger, front elements from rotating during AF or zoom operation. Minimum focus is 4.6' at all zoom settings and can fill the frame with a subject as small as 4.8 x 7.2" at the 300mm zoom setting. Includes a ET-65B lens hood and LP1116 soft lens case. Filter size is 58mm.....IMP. 1129.95 / USA 1149.95



CAMERAS & LENSES

43

ORDER & INFO. (212) 502-6340 • FAX: (212) 239-7770 (800) 947-7008  
1-800-290-6750 • www.bhphotovideo.com





# CANON

## EF LENSES

CAMERAS & LENSES

44

### TELEPHOTO ZOOM LENSES

#### **EF 75-300mm f/4-5.6 III USM**

Compact and lightweight, this 4x telephoto zoom lens is ideal for shooting sports, portraits and wildlife. Features an improved zoom mechanism for smoother zooming. The front part of the zoom ring sports a silver ring for a luxury touch. Filter size is 58mm.

CA7530043EF.....IMP. 169.95 / USA 189.95

#### **EF 75-300mm f/4-5.6 IS USM**

Like the EF 28-135 IS USM, the EF 75-300mm f/4-5.6 IS USM has a built-in image stabilizer to dramatically reduce the chance of a blurred photograph due to camera motion – especially when shooting at long focal lengths with slow shutter speed. Turn the image stabilizer on and you can shoot sharp, natural-looking pictures in dim lighting without using a flash or a tripod. Shoot at 200mm with a shutter speed of only 1/60th second!

CA753004ISEF.....IMP. 399.95 / USA 414.95

#### **EF 80-200mm f/4.5-5.6 II**

Compact and lightweight (3.1" long and 8.8 oz.), the EF 80-200 telephoto zoom is very easy to carry around, and is a great choice for travel and other applications where portability is a priority. Its optical quality is assured by a five-group zooming system. Filter size is 52mm.

CA80200452EF.....IMP. 109.95 / USA 119.95

#### **EF 100-300mm f/4.5-5.6 USM**

Only 4.8" long, this practical and portable zoom lens offers full-time manual focusing mode which lets you switch to manual focus even in AF mode. With rear focusing, the lens doesn't change length or rotate during focusing, so filter effects remain intact. It also makes autofocusing quick and quiet. Filter size is 58mm.

CA10030045EF.....IMP. 269.95 / USA 279.95



EF 100-300mm f/4.5-5.6 USM

EF 75-300mm f/4-5.6 III USM



EF 75-300mm f/4-5.6 IS USM

EF 100-400mm f/4.5-5.6L IS USM



#### **EF 100-400mm f/4.5-5.6L IS USM**

Incorporating fluorite and Super UD-glass elements, this super telephoto zoom ensures high quality at all focal lengths. Built-in dual-mode Image Stabilizer reduces camera shake up to two full shutter speeds compared to hand-held shooting with a conventional lens. Autofocus is fast and silent with ring-type USM. Advanced, lightweight rear focusing design incorporates a floating element for consistent image quality at all distances from 5.9' to infinity.

With full-time manual focus, one-touch zooming with a wide grip, and a ring for adjustment of zooming friction, this lens is extremely easy to use and is ideal for a wide variety of applications including nature, wildlife, sports, and documentary photography. Includes a tripod collar, ET-83C lens hood and LZ-1324 case. Filter size is 77mm.

CA10040045LE.....IMP. 1379.95 / USA 1409.95

**Canon USA Lenses include a 1-Year Canon Warranty, and many have rebates available.**

**Please go on-line or call us for details and expiration dates before purchasing.**

USA= Imported & Warrantied by Canon USA

IMP. = Imported & Warrantied by B&H (not qualified for Canon USA rebates and warranties)



**ONE HOUR FREE PARKING**

**AT 349 W. 34th STREET (with purchase of \$100 or more)**

# CANON

## EF LENSES

| EF Lenses                       | Angle of View<br>Diagonal | Groups<br>Elements | Closest Focusing<br>Distance | Weight   | Lens<br>Hood | Filter<br>Size | Case   |
|---------------------------------|---------------------------|--------------------|------------------------------|----------|--------------|----------------|--------|
| Fish-eye EF 15mm f/2.8          | 180°                      | 7-8                | 0.7                          | 11.6 oz. | Built-in     | Gelatin        | LP814  |
| EF 14mm f/2.8L USM              | 114°                      | 10-14              | 0.8'                         | 19.8 oz. | Built-in     | Gelatin        | LP1016 |
| EF 20mm f/2.8 USM               | 94°                       | 9-11               | 0.8'                         | 14.3 oz. | EW-75II      | 72             | LP1214 |
| EF 24mm f/1.4L USM              | 84°                       | 9-11               | 0.8'                         | 19.4 oz. | EW-83DII     | 77             | LP1214 |
| EF 24mm f/2.8                   | 84°                       | 10-10              | 0.8'                         | 9.5 oz.  | EW-60II      | 58             | LP811  |
| EF 28mm f/1.8 USM               | 75°                       | 9-10               | 0.8'                         | 10.9 oz. | EW-63II      | 58             | LP814  |
| EF 28mm f/2.8                   | 75°                       | 5-5                | 1.0'                         | 6.5 oz.  | EW-65II      | 52             | LP1011 |
| EF 35mm f/1.4L USM              | 63°                       | 9-11               | 0.98'                        | 20.5 oz. | EW-78CII     | 72             | LP1214 |
| EF 35mm f/2                     | 63°                       | 5-7                | 0.8'                         | 7.4 oz.  | EW-65II      | 52             | LP1011 |
| EF 50mm f/1.4 USM               | 46°                       | 6-7                | 1.5'                         | 10.2 lb. | ES-71II      | 58             | LP1014 |
| EF 50mm f/1.8 II                | 46°                       | 5-6                | 1.5'                         | 4.6 lb.  | ES-62#       | 52             | LP1014 |
| EF 85mm f/1.2L USM              | 28° 30'                   | 7-8                | 3.1'                         | 2.3 lb.  | ES-79II      | 72             | LP1219 |
| EF 85mm f/1.8 USM               | 28° 30'                   | 7-9                | 2.8'                         | 14.9 oz. | ET-65III     | 58             | LP1014 |
| EF 100mm f/2 USM                | 24°                       | 6-8                | 2.9'                         | 16.1 oz. | ET-65III     | 58             | LP1014 |
| EF 135mm f/2L USM               | 18°                       | 8-10               | 2.95'                        | 26.3 oz. | ET-78II      | 72             | LP1219 |
| EF 135mm f/2.8 w/ Soft Focus    | 18°                       | 6-7                | 4.3'                         | 13.8 oz. | ET-65III     | 52             | LP1016 |
| EF 200mm f/2.8L II USM          | 12°                       | 7-9                | 4.92'                        | 26.8 oz. | ET-83BII     | 72             | LP1222 |
| EF 300mm f/2.8L IS USM          | 8° 15'                    | 13-17              | 8.2'                         | 5.6 lb.  | ET-120       | 52 DI          | 300    |
| EF 300mm f/4L IS USM            | 8° 15'                    | 11-15              | 4.92'                        | 2.6 lb.  | Built-in     | 77             | LZ1128 |
| EF 400mm f/2.8L IS USM          | 6° 10'                    | 13-17              | 9.8'                         | 11.7 lb. | ET-155       | 52 DI          | 400    |
| EF 400mm f/4 DO IS USM          | 6° 10'                    | 13-17              | 11.5'                        | 4.3 lb.  | ET-120       | 52 DI          | 400B   |
| EF 400mm f/5.6L USM             | 6° 10'                    | 6-7                | 11.5'                        | 2.8 lb.  | Built-in     | 77             | LZ1132 |
| EF 500mm f/4L IS USM            | 5°                        | 13-17              | 14.8'                        | 8.5 lb.  | ET-138       | 52 DI          | 500    |
| EF 600mm f/4L IS USM            | 4° 10'                    | 13-17              | 18'                          | 11.8 lb. | ET-160       | 52 DI          | 600    |
| MP-E 65mm f/2.8 1-5x Macro*     | 18° 40' (at 1x)           | 8-10               | 0.8'                         | 25.8 oz. | -            | 58             | LP1216 |
| EF 50mm f/2.5 Compact Macro     | 46°                       | 8-9                | 0.75'                        | 9.9 oz.  | -            | 52             | LP814  |
| EF 100mm f/2.8 Macro USM        | 24°                       | 8-12               | 0.31'                        | 21.1     | ET-67        | 58             | LP1219 |
| EF 180mm f/3.5L Macro USM       | 13° 40'                   | 12-14              | 0.48'                        | 2.4 lb.  | ET-78II      | 72             | LZ1324 |
| EF 16-35mm f/2.8L USM           | 108° 10'-63°              | 10-14              | 0.28'                        | 1.3 lb.  | EW-83E       | 77             | LP1319 |
| EF 17-40mm f/4L USM             | 74-29°                    | 9-12               | 11"                          | 17.6 oz. | EW-83E       | 77             | LP1319 |
| EF 20-35mm f/3.5-4.5 USM        | 94°-63°                   | 11-12              | 0.34'                        | 11.9 oz. | EW-83II      | 77             | LP1214 |
| EF 24-70mm f/2.8L USM           | 74°-29°                   | 13-16              | 1.25'                        | 2.1 lb.  | EW-83F       | 77             | LP1219 |
| EF 24-85mm f/3.5-4.5 USM        | 84°-28° 30'               | 12-15              | 0.5'                         | 13.4 oz. | EW-73II      | 67             | LP1014 |
| EF 28-80mm f/3.5-5.6 II         | 75°-30°                   | 10-10              | 1.25'                        | 0.44 lb. | EW-60C       | 58             | LP814  |
| EF 28-90mm f/4-5.6 II USM       | 75°-27°                   | 8-10               | 0.38'                        | 6.7 oz.  | EW-60C       | 58             | LP814  |
| EF 28-90mm f/4-5.6 III          | 75°-27°                   | 8-10               | 0.38'                        | 6.7 oz.  | EW-60C       | 58             | LP814  |
| EF 28-105mm f/3.5-4.5 II USM    | 75°-23° 20'               | 12-15              | 0.5'                         | 13.1 oz. | EW-63II      | 58             | LP814  |
| EF 28-105mm f/4-5.6 USM         | 75°-23° 20'               | 9-10               | 0.5'                         | 13.1 oz. | EW-63B       | 58             | LP814  |
| EF 28-135mm f/3.5-5.6 IS USM    | 75°-18°                   | 12-16              | 0.5'                         | 18.9 oz. | EW-78BII     | 72             | LP1116 |
| EF 28-200mm f/3.5-5.6 USM       | 75°-12°                   | 12-16              | 0.45'                        | 17.6 oz. | EW-78D       | 72             | LP1116 |
| EF 35-80mm f/4-5.6 III          | 63°-30°                   | 8-8                | 1.3'                         | 6.2 oz.  | EW-54II      | 52             | LP814  |
| EF 55-200mm f/4.5-5.6 II USM    | 43°-12°                   | 22-29              | 1.2'                         | 10.9 oz. | ET-54        | 52             | LP1016 |
| EF 70-200mm f/2.8L IS USM       | 34°-12°                   | 18-23              | 1.4'                         | 3.2 lb.  | ET-86        | 77             | LZ1324 |
| EF 70-200mm f/2.8L USM          | 34°-12°                   | 15-18              | 1.5'                         | 2.9 lb.  | ET-83II      | 77             | LZ1324 |
| EF 70-200mm f/4L USM            | 34°-12°                   | 13-16              | 1.2'                         | 25.0 oz. | ET-74        | 67             | LP1224 |
| EF 70-300mm f/4.5-5.6 DO IS USM | 34°-12°                   | 12-18              | 4.6'                         | 1.6 lb.  | ET-65B       | 58             | LP1116 |
| EF 75-300mm f/4-5.6 IS USM      | 32° 11'-8°15'             | 10-15              | 1.5                          | 1.5 lb.  | ET-64II      | 58             | LP1022 |
| EF 75-300mm f/4-5.6 III USM     | 32° 11'-8°15'             | 9-13               | 1.5                          | 16.8 oz. | ET-60        | 58             | LP1019 |
| EF 75-300mm f/4-5.6 III         | 32° 11'-8°15'             | 9-13               | 1.5                          | 16.8 oz. | ET-60        | 58             | LP1019 |
| EF 80-200mm f/4.5-5.6 II        | 30°-12°                   | 7-10               | 1.5                          | 8.8 oz.  | ET-54        | 52             | LP1014 |
| EF 100-300mm f/4.5-5.6 USM      | 24°-8° 15'                | 10-13              | 1.5                          | 1.2 lb.  | ET-65III     | 58             | LP1019 |
| EF 100-400mm f/4.5-5.6L IS USM  | 24°-6° 10'                | 14-17              | 1.8                          | 3.0 lb.  | ET-83C       | 77             | LZ1324 |

CAMERAS & LENSES

45

ORDER & INFO. (212) 502-6340 • FAX: (212) 239-7770 (800) 947-7008  
**1-800-290-6750 • www.bhphotovideo.com**



# CANON

## EF LENS ACCESSORIES

CAMERAS & LENSES

46



### Lens Hoods

- EW-75II (CAEW752) For 20mm/2.8 .....43.95
- EW-60II (CAEW602) For 24mm/2.8 .....23.95
- EW-65II (CAEW652)  
For 28mm/2.8, 35mm/2.0 lenses .....23.95
- EW-63II (CAEW632)  
For 28mm/1.8 USM 28-105mm/3.5-4.5 II  
USM lenses .....23.95
- ES-71II (CAES712) For 50mm/1.4 lens ...26.95
- ES-62 (CAES62HA)  
For the 50mm/1.8 lens. With the Hood  
Adapter 62.....23.95
- ET-65III (CAET653)  
For the 85/1.8, 100/2.0, 135/2.8 SF and  
100-300/4.5-5.6 USM lenses .....23.95
- ET-67 (CAET67)  
For the 100mm/2.8 Macro lens .....39.95
- ET-78II (CAET782)  
For the 180mm/3.5L Macro lens .....39.95
- EW-83II (CAEW832)  
For 20-35mm/3.5-4.5 lens .....29.95
- EW-73II (CAEW732)  
For 24-85mm/3.5-4.5 lens .....23.95
- EW-60C (CAEW60C)  
For 28-80mm/3.5-5.6II, and 28-90mm/4-5.6  
lenses .....23.95
- EW-63B (CAEW63B)  
For 28-105mm/4-5.6 USM lens.....23.95
- EW-78BII (CAEW78B2)  
For 28-135/3.5-5.6 IS USM lens .....26.95
- EW-78D (CAEW78D)  
For 28-200mm/3.5-5.6 USM lens.....37.95
- EW-54II (CAEW542)  
For 35-80mm/4-5.6 III lens .....23.95
- ET-54 (CAET54)  
For 55-200mm/4-5.6 II USM and  
80-200mm/4-5.6 II lenses .....23.95
- ET-64II (CAET642)  
For 75-300mm/4-5.6 IS USM lens .....26.95
- ET-60 (CAET60)  
For 75-300mm/4-5.6 III and  
75-300mm/4-5.6 III USM.....23.95

## FILTERS

### Haze UV-1 Filters

A great investment, UV-1 Haze filters will protect your valuable lenses from dust, moisture and scratches, which can lead to costly repairs. If desired they can be left on the lens at all times for protection. They also have a very subtle warming effect, which can be useful to counter the "cool" colors you sometimes get in bright sun or in shade.

### Softmat Filters

These filters are used to produce soft focus effects. A coated pattern over the filter diffracts some of the light passing through. Softmat #1 produces a gentle soft focus effect, ideal for lending a romantic aura to portraits; Softmat #2 offers a stronger effect producing a fog-like effect in landscapes. Both can be used together for stronger effects



### Circular Polarizer (PL-C)

Polarizing filters are used to increase subject contrast by controlling reflected light from non-metallic surfaces. Useful for reducing or eliminating reflections from glass and water. Will also darken blue skies in some conditions. Simple to use, circular polarizing filters polarize light circularly, rather than linearly, so it does not interfere with autofocus or TTL light metering.

### FILTER PRICING

| Filter Type        | 52mm                 | 58mm                 | 72mm                  | 77mm                  |
|--------------------|----------------------|----------------------|-----------------------|-----------------------|
| UV Haze            | CAUV52<br>10.95      | CAUV58<br>12.95      | CAUV72Q<br>24.95      | CAUV77Q<br>34.95      |
| Softmat #1         | CASM152<br>34.95     | CASM158<br>36.95     |                       |                       |
| Softmat #2         | CASM252<br>34.95     | CASM258<br>36.95     |                       |                       |
| Circular Polarizer | CACP52<br>59.95      | CACP58<br>84.95      | CACP72<br>109.95      | CACP77<br>124.95      |
| 250D Close-up Lens | CACUL250D52<br>71.95 | CACUL250D58<br>86.95 |                       |                       |
| 500D Close-up Lens | CACUL500D52<br>71.95 | CACUL500D58<br>86.95 | CACUL500D72<br>119.95 | CACUL500D77<br>139.95 |

### 52mm Drop-in Circular Polarizer PL-C (CACPDI52)

Same as the standard circular polarizer (above), except these filters are for lenses using rear-mounted drop-in filters. The filters can be rotated from the outside without removing the holder from the lens. Designed for the EF 300/2.8L, 400/2.8L, 500/4.5L and 600/4L USM lenses.....166.95



### Replacement 52mm Drop-in Gelatin Filter Holder II (CAFHG52)

Glass-backed holder accepts up to three commercially available cut-to-size gelatin filters for rear-insertion. (Provided standard with the EF 300mm f/2.8L IS, 400mm f/2.8L IS, 500mm f/4L IS and 600mm f/4L IS USM lenses.).....Call

### 52mm Drop-in Screw Filter Holder (CAFHS52)

The enclosed regular filter can be exchanged with other commercially available screw-type filters. Note that only filters with correct filter frame thickness can be mounted on the lens.....83.95



EQUIPMENT LEASING AVAILABLE

# CANON

## EF LENS ACCESSORIES

### FILTER HOLDERS

#### Gelatin Filter Holder III & IV

Allows 3" or 4" square gelatin filters to be fitted to most EF lenses. Requires Gelatin Filter Holder Adapter. Can be combined with optional Gelatin Filter Holder Hoods III or IV.

**Gel Filter Holder III**  
for 3 x 3" Gels (CAFH3):  
Requires adapter ring .....**64.95**

**Gel Filter Holder IV**  
for 4 x 4" Gels (CAFH4):  
Requires adapter ring .....**74.95**



#### Gelatin Filter Holder Hoods III & IV



Attaches to front of Gelatin Filter Holder III or IV to block stray light. Approximately 1/2" deep, multiple hoods can be "stacked" to increase the length for telephoto lenses.

**Gel Filter Holder Hood III (CAHFH3)** .....**26.95**  
**Gel Filter Holder Hood IV (CAHFH4)** .....**26.95**

#### Gelatin Filter Holder Adapter III & IV

These are adapter rings used to attach Gelatin Filter Holder III or IV to most EF lenses. Available in 52, 58, 67, 72 and 77mm.



##### FOR GELATIN III

**52mm (CAAR52FH3)**.....**29.95**  
**58mm (CAAR58FH3)**.....**29.95**  
**67mm (CAAR67FH3)**.....**29.95**  
**72mm (CAAR72FH3)**.....**29.95**  
**77mm (CAAR72FH3)**.....**29.95**

##### FOR GELATIN IV

**52mm (CAAR52FH4)**.....**Call**  
**58mm (CAAR58FH4)**.....**29.95**  
**67mm (CAAR67FH4)**.....**29.95**  
**72mm (CAAR72FH4)**.....**29.95**  
**77mm (CAAR72FH4)**.....**29.95**

### Close-up Lenses

These close-up attachments can be used with most EF lenses to provide a shorter minimum focusing distance with no loss of light. The 250D/500D series incorporates double-element achromatic design for maximum optical performance while the 500 series features single-element construction for maximum economy. The 250D is optimized for lenses between 50-135mm, while the 500D works best with telephoto lenses from 70-300mm. Manual focusing is recommended. Available in 52mm, 58mm, 72mm, 77mm (see box on previous page for prices).



#### Extension Tube EF12 II & EF25 II

These close-up accessories maintain full electronic coupling between the camera body and lens, often providing greater magnification than is possible with close-up lenses. Can be used with most EF lenses, and are ideal for nature photography with single focal length telephotos. Manual focusing is recommended.

**Extension Tube EF12 II (CAETEF12Q)** .....**79.95**  
**Extension Tube EF25 II (CAETEF25Q)** .....**129.95**



### Lens Pouches

**LP814 (CALP814)**  
For 15mm/2.8, 28mm/1.8 USM, 50mm/2.5 macro, 28-80mm f/3.5-5.6 II, 28-90mm f/4-5.6II, 28-90mm f/4-5.6II USM, 28-105mm f/3.5-4.5 II USM, 28-105mm f/4-5.6 USM, 35-80mm f/4-5.6 III .....**23.95**

**LP816 (CALP816)**  
For 100mm f/2.8 Macro USM .....**23.95**

**LP1214 (CALP1214)**  
For 20mm/2.8 lens .....**23.95**

**LP811 (CALP811)**  
For 24mm/2.8 lens .....**23.95**

**LP1011 (CALP1011)**  
For 28mm/2.8, 35mm/2.0 lenses .....**23.95**

**LP-1014 (CALP1014)**  
For 80-200 f/4.5-5.6 II lens .....**23.95**

**LP-1016 (CALP1016)**  
For 135mm f/2.8 Soft Focus and 55-200mm f/4.5-5.6 USM II lenses .....**28.95**

**LP-1019 (CALP1019)**  
For 75-300mm f/4-5.6 III USM, 100-300mm f/4.5-5.6 USM lenses .....**23.95**

**LP-1022 (CALP1022)**  
For 75-300mm f/4-5.6 IS USM .....**23.95**

**LP-1116 (CALP1116)**  
For 28-135mm f/3.5-5.6 IS USM lens ...**23.95**

**LP-1214 (CALP1214)**  
For 20mm/2.8, 20-35mm f/3.5-4.5 USM ..**23.95**

**LP-1216 (CALP1216)**  
For MP-E 65mm f/2.8 macro .....**23.95**

**LP-1219 (CALP1219)**  
For 100mm f/2.8.....**31.95**

### Lens Caps

**Lens Dust Cap E (CALCRE):** Replacement rear lens cap for EF lenses, teleconverters and extension tubes .....**6.95**

**Lens Cap E-52 (CALCE52):** 52mm snap-on lens cap.....**7.95**

**Lens Cap E-52U (CALCE52U):** 52mm "Ultrasonic" snap-on lens cap .....**7.95**

**Lens Cap E-58 (CALCE58):** 58mm snap-on lens cap.....**7.95**

**Lens Cap E-58U (CALCE58U):** 58mm "Ultrasonic" snap-on lens cap.....**7.95**

**Lens Cap E-72U (CALCE72U):** 72mm "Ultrasonic" snap-on lens cap.....**7.95**

# HASSELBLAD

## XPAN II

### **Dual-Format (35mm and Panorama) Camera**

*Sometimes your world doesn't fit in the frame. Sometimes you want to think a bit outside the box. So for all those times when you need a little something extra, Hasselblad presents the XPan II – the world's only truly dual-format 35mm camera system. The XPan II is a unique camera that takes great 35mm shots with world-renown Hasselblad quality and full, medium format panorama pictures — and both formats can be mixed in any order on the same roll of 35mm film. Easy-to-use, simply flick a switch and your view expands. Switch between standard 35mm and medium format quality, full panorama as many times as you wish—with no empty spaces or wasted film. And without sacrificing image quality or lugging around*



*extra equipment, without changing magazines or cameras, without losing the moment in front of you.*

*The XPan II features a wide range of convenient, user-friendly features such as automated film loading film transport, TTL exposure metering, and single or continuous exposure. The shutter release can be triggered by button, mechanically, via a dedicated remote cable, or self-timer. And being a rangefinder camera, the Xpan II is very silent in operation.*

*Finally, the outstanding image quality and full panorama effect of the XPan II is made possible by the superb optical quality of specially designed lenses. These superior, highly compact lenses, are actually medium format lenses, but have the compact external dimensions of 35mm lenses. Together with the XPan II, they provide the bridge between the image quality of the medium format and the convenience and economy of the 35mm format.*

### **FEATURES**

#### **Maximum Quality—35mm or Panorama**

- ◆ Inside the XPan II's sleek body lies an ingenious system that allows you to choose between formats without sacrificing quality along the way. You get Hasselblad tradition and reliability combined with 35mm convenience. You get razor sharp images combined with a panorama negative almost three times larger than traditional masking techniques and over five times larger than those produced by APS cameras. No compromises, just possibilities.
- ◆ Behind the simplicity of the XPan II's exterior is a unique system that provides medium format image quality on 35mm film. The XPan II utilizes the entire area of standard 35mm film for either format, providing a panorama effect without masking the film or reducing image quality. This specially designed technique gives you the same superior quality you expect from Hasselblad.
- ◆ The XPan provides superior quality panorama shots and standard shots, mixed on the same roll of inexpensive 35mm film. No other camera in the world can offer the same.
- ◆ Both of the XPan II's formats can be mixed freely on the same roll of 35 mm film in any order, with no wasted film. Even when switching back and forth from regular 35 mm to panorama in midroll, the camera's film counter automatically compensates and shows the number of remaining shots at your current format.
- ◆ A lot of so-called "panorama" cameras claim to offer panorama mode, but in reality all they do is crop off the top and bottom of a standard 35 mm frame. When the whole idea behind panorama pictures is their size, lopping off your negative or slide is really only faking it, losing image quality as well.
- ◆ With the XPan II however, a mere turn of a knob expands the standard 35mm image, producing an image just as high but nearly twice as long. In other words, the XPan II is two cameras in one: a high quality 35mm camera and a true panorama format camera, rolled into one stylish package. Brings the convenience of the 35mm world and the image quality of the medium format world together at last.

XPan II Camera Body (HAX2): With strap, two CR2 3v lithium batteries, spirit level and quick coupling plate.....2143.00

XPan II Camera Kit (HAX2K): With 45mm f/4 lens, strap, two CR2 3v lithium batteries, spirit level and quick coupling plate.....2499.95



For Any Inquiries Regarding Your Order, Call Our Customer Service:  
(800) 221-5743 • (212) 239-7765 • FAX: (800) 947-2215 • (212) 239-7549

# HASSELBLAD

## XPan II

### User-Friendly

- ◆ While professional in design and image quality, the XPan II is a snap to use, featuring center-weighted TTL exposure metering (with manual override).
- ◆ Film loading and winding is easy. The camera automatically detects film speed (programmable auto DX with ISO override) and pre-winds the film onto the camera spool. It then rolls each exposed frame back into the film cassette. This protects the exposed film inside even if the camera is opened by mistake. It also reduces the risk of camera noise, as film is wound when you choose to load film, not at the unexpected end of a roll. And since rangefinder cameras have no reflex mirror to make noise when exposing a shot, the XPan II is virtually silent in operation.

### Viewfinder & LCD

- ◆ The bright-frame viewfinder and coupled rangefinder make viewing and focusing easy and intuitive. Viewfinder information is adjusted automatically, reflecting the format and the focal length of the lens.
- ◆ An LCD display in the viewfinder shows shutter speed, exposure compensation, and symbols for exposure offset. A smaller LCD display, showing format and number of exposures remaining, is conveniently located on the top of the camera.
- ◆ The LCD on the Xpan II's rear displays ISO, shutter speed, exposure compensation, auto bracketing, self-timer delay time, sync mode, rewind mode, multi exposure, battery status, and exposure history.

### High Performance

- ◆ Shoot single frame or continuous at up to three standard or two panorama frames per second.
- ◆ Rewind mode can also be set to leave the film tip exposed for easier extraction and flash sync can be programmed to trigger at the beginning or end of exposure.
- ◆ User functions such as auto bracketing (three consecutive exposures at 0.5 or 1 EV increments) with either single or continuous exposure, exposure compensation ( $\pm 2$  EV at 0.5 EV increments), and multi-exposure mode (up to 9 exposures per frame) can be programmed via the rear display.

### Optional Hasselblad Lenses for the XPan II



A camera as unique as the XPan II requires a series of lenses as unique as the camera itself. That's exactly what Hasselblad offers in the form of the X-Pan system's three light, interchangeable, and extremely compact medium format lenses – the 30mm f/5.6, 45mm f/4 and 90mm f/4. These lenses have been specially designed to produce superior performance, resolution, and contrast and to provide image circles as large as those of 6x4.5 medium format lenses.

These unique lenses are what make the outstanding quality and full panorama format possible, and are the key to producing medium format quality on 35 mm film. Multicoated glass elements

ensure top quality results, providing brilliant contrast and full tonal scale. Optical aberrations are well corrected, with almost no color fringing and extremely low distortion, even with the extreme-wide angle coverage of the 30mm lens. The smooth action of the focusing ring guarantees quick and accurate focusing. All lenses feature automatic coupling of the focusing mechanism to the camera rangefinder, a rear bayonet fitting for camera attachment, and a front bayonet fitting for lens shade. To meet the highest requirements for even corner-to-corner illumination, the 30mm Aspherical and 45mm lenses can be fitted with a dedicated center filter.

#### 30mm f/5.6 Aspherical (HA3056X)

When used for the 24x65 mm panorama format, this ultra-wide-angle lens provides a horizontal view of almost 94° and retains its superb performance over the entire image field with virtually no distortion. The lens comes with an auxiliary viewfinder, attached to the camera's flash shoe, containing built-in spirit level and field markings for the regular and panorama formats. The camera's rangefinder is used for focusing only. Complete with a lens shade and a dedicated 58mm center filter.....**2849.95**

#### 45mm f/4 (HA454X)

The very compact design and high image quality of the 45mm makes this lens the obvious choice as the standard XPan II camera lens. When used for panorama images the lens has a true wide-angle horizontal coverage of 71°. The dedicated 49 mm center filter is recommended for critical situations where transparency film is used. The center filter is normally not required when using negative film if the lens is stopped down to f/8 or smaller aperture.....**569.95**

#### 90mm f/4 (HA904X)

This lens is ideally suited for general purpose photography when a wide-angle effect is not desired. When used for regular 24x36mm images, it provides a telephoto perspective, when used for panorama images the telephoto effect is moderate but clearly visible.....**689.95**



# HASSELBLAD

## XPAN II

CAMERAS & LENSES

50

### XPAN II SPECIFICATIONS

|                     |   |
|---------------------|---|
| Film Type           | 35mm  |
| Format              | Rangefinder camera with focal plane shutter: Dual Format: 35mm (24 x 36mm) and full format panorama (24 x 65mm); switchable mid-roll using a format selector switch on back of camera.            |
| Frames Per Roll     | 24 or 36 in 35mm format; 13 or 21 frames in panorama format (from 24 and 36 exposure cassettes); Frame rate 1.2 frames per sec. for 24 x 36 mm format   |
| Lens Mount          | Bayonet; Xpan lenses ONLY   |
| Focusing            | Manual focus; helicoid interlocked to coupled rangefinder   |
| Exp. Modes          | Aperture Priority, Manual   |
| Exp. Metering       | TTL measured at shutter plane; Center-weighted averaging  |
| Exp. Metering Range | Ev 4 - 19   |
| Exp. Compensation   | +/- 2 stops in 1/2 stop increments  |
| Exp. Bracketing     | ± 2 stops in 1/2 or full stop increments  |
| Flash               | None; Flash sync speed up to 1/125 sec.; Flash sync at the beginning or end of exposure   |
| Shutter Speed       | Focal plane shutter; 1/1000 to 8 sec., Bulb (maximum to 540 sec.), flash sync speed up to 1/125 sec.; fired by shutter or cable release; 1 EV step control on manual; 1/2 EV control on automatic |
| ISO Range           | 25-3200 DX coded; Manually overridable  |
| Film Wind           | Single shot advance, Continuous at 1.2fps. with 24 x 36mm format; automatic "wind-on" and auto rewind; Rewind of film with option to leave a film tip out of the cassette                         |
| Focusing Screen     | Non-interchangeable   |
| Diopter Correction  | Interchangeable from -4 to +2; Diopter lens with locking system   |
| Self Timer          | Delay 2 or 10 sec.  |
| Remote Control      | Optional; Electrical remote release (optional release cord)   |
| PC Terminal         | Yes   |
| Multiple Exposure   | Up to 9 exposures   |
| Viewfinder Info     | Bright-frame; automatic parallax correction; field of view is 85%; Shows shutter speed and exposure information   |
| LCD Information     | LCD display in the viewfinder   |
| Power Source        | (2) CR2 3v lithium batteries  |
| Dimensions          | 2.04 x 6.64 x 3.28" L x W x D   |
| Weight (Body only)  | 25.2 oz. (without batteries)  |

### XPAN II ACCESSORIES

**Lens Shades:** Efficiently shields the lens from stray light for the best possible image contrast, and provides protection to the front lens element. They are lockable to prevent unintentional movement.  
**For 30mm Lens (HALH30X).....94.95**  
**For 45 & 90mm Lenses (HALHXQ) ..79.95**



Release Cord

Lens Shade

Center Filter

**Center Filter:** Ensures the highest corner-to-corner illumination by neutralizing the natural effect of light fall-off that may be apparent in critical applications on transparency film in the panorama format at large aperture settings.  
**For 30mm Lens (HACF30X) .....334.00**  
**For 45mm Lens (HACF45X) .....278.00**

**Release Cord (HARCX2):** 3' release cord for electrical remote shutter release of the XPan II .....**118.00**

**Spirit Level (HASLX):** Attaches to the camera accessory shoe. Used to level the camera body for both horizontal and vertical formats. Comes supplied with the camera body.....**34.95**

**Quick Coupling Plate (HAQRPX2):** Allows you to use the Tripod Quick-coupling S (45144) for rapid, secure attachment and repeatable alignment .....**38.95**

**XPan Strap (HASX):** Replacement genuine leather strap for XPan camera. Supplied with the camera body .....**44.95**

**Eyepiece Correction Lenses:** The XPan II viewfinder can be customized to suit individual eyesight. The available diopter range of the correction eyepieces is wide enough to meet virtually all individual preferences. Correction eyepieces can be locked in place and are rubber coated to prevent damage to eyeglasses. Correction eyepieces for the XPan II can also be used with the original XPan.

- 4 Correction Lens (HADM4X2) .....**44.95**
- 3 Correction Lens (HADM3X2) .....**44.95**
- 2 Correction Lens (HADM2X2) .....**44.95**
- 0 Correction Lens (HAD0X2) .....**44.95**
- +0.5 Correction Lens (HADP.5X2) ....**44.95**
- +2 Correction Lens (HADP2X2) .....**44.95**

**Leather Case (HACX):** An elegant shoulder bag in soft leather with an adjustable contoured shoulder strap with non-slip underside. 10.8 x 5.2 x 10.4" (LxWxH) .....**124.00**



Leather Case

Ever Ready Case

**Ever Ready Case (HACEX):** A soft leather case designed for both the XPan and XPan II, the top can be separated for convenient camera operation. The bottom part is attached to the camera with a screw fit to the tripod thread .....**86.00**





# NOBLEX

## 135 SERIES

### 35mm Panoramic Cameras

Panoramic photography, and especially the super wide photos produced from panoramic cameras have always inspired fascination. As in normal human vision, the rotating shutter slit reproduces the entire extension of landscape, interior architecture, the gentle curve of a river, incorporating all that our eyes see before us. With panoramic photography, dimensions begin to interact and as a result, heighten their effect on each other. Perspective lines lead from foreground to the horizon: the castle on the square, a cluster of trees in a field, the relationship of a river bank to its surroundings; in essence, the panorama which our eyes see is duplicated by the camera. So what is the magic of these photos that captivates us so? The feeling of width? An undistorted photographic rendition of what we have seen? Perhaps simply the chance for the photographer to both see as well as photograph a true rendition of a scene. And, unlike "conventional" photography, the ability to record these scenes without having to discard what the eye truly sees.



CAMERAS & LENSES

51



conventional small format camera with 28 mm lens



comparative exposure with small format camera Noblex 135 (135° picture angle)

Noblex's 135 Series of panorama cameras operate along the same principle: a rotating drum/lens revolves around a curved film plane. As light enters the front of the lens, this light is passed through a 4mm slit at the rear of the lens, completing the exposure. The rotating lens drum is driven by a high performance DC motor and makes one revolution per exposure. During the first half the drum reaches a constant speed and will thus produce an absolutely even exposure during the second half. The click stopped exposure speeds are created by variation in the drum speed. It is possible to produce different types of multiple exposures, for instance extremely long exposures, picture montage and stroboscopic multi-

exposure Noblex pictures are genuine panorama photographs with an angle of 136° and correspond to the natural space perception of the human vision. They are ideal for landscape, architectural landscape and travel photography, group portraits, wedding, sport, and still life photography.

### 135 Prosport

- ◆ Noblar 2.9mm 4.5 lens; fixed focus
- ◆ 5 shutter speeds (1/500 to 1/30 of a second)
- ◆ Powered by 4 AAA batteries
- ◆ 1/4" tripod socket on the bottom of the camera
- ◆ Provides 19 shots on a roll of 35mm 35 exposure film
- ◆ Magnetic filter attachment
- ◆ Accepts standard cable release

NO135P .....999.00

### 135U

Same as the 135 Prosport, PLUS—

- ◆ 10 shutter speeds (1/500 to 1 second)
- ◆ Lens shift capability for architectural applications
- ◆ Built-in spirit level ◆ Multiple exposure capability
- ◆ Compatible with optional Panolux 135 Exposure Module for automatic metering

NO135U.....1795.00

### Optional Filters and Accessories

- UV Haze Filter (NOUV35) .....49.95
- Yellow Green (11) Filter (NOYG35)...49.95
- Yellow (K2) Filter (NOY35).....49.95
- Orange (G15) Filter (NOO35) .....49.95
- Red (25A) Filter (NOR35) .....49.95
- Skylight (1A) Filter (NOSL35) .....49.95
- Skylight (81A) Filter (NOSL35Q) .....49.95
- 4x Neutral Density (NOND435).....49.95
- 8x Neutral Density (NOND835).....49.95



- VR-3 Panoramic Head (NOVR3) Facilitates easy alignment of panoramic photos, and provides 3 indented click stops at 0°, 120° and 240°. Other rotation angles can be easily adjusted with applied graduations of 15°. A locking screw insures rock steady alignment. Panoramic photos are easily formatted in stitching software programs. 1/4" and 3/8" tripod studs are mounted on the bottom of the VR-3.....283.50

- Tweezer Tool (NOT) For filters .....18.95

ORDER & INFO. (212) 502-6340 • FAX: (212) 239-7770 (800) 947-7008  
1-800-290-6750 • www.bhphotovideo.com



# KENKO

## LENS ADAPTERS

### Teleplus

#### Teleconverters for SLR Cameras

Placed between the camera body and lens, a teleconverter contains a set of optics that will effectively



increase the focal length of any lens it is used with. Kenko's 1.5x and 2x Teleplus converters have the effect of multiplying the focal length of your lens by 1.5x or 2.0x. For example, using the MC1.5 with a 300 mm lens will effectively increase the focal length to 450mm. Using the MC4 2x teleconverter with a 300mm lens will effectively increase the focal length to 600mm. They are an easy and inexpensive way to increase the abilities of your telephoto lens without the expense of purchasing and carrying another telephoto lens. Kenko Teleplus converters are small and easy to carry in your camera bag.

Kenko's converters have genuine Gate Array IC (Integrated Circuitry). It means the converter's unique circuitry maintains signal integrity between the camera body and lens. Their 4- and 7-element design is made with high quality multicoated optical glass supplied by Hoya Corporation, the worlds largest manufacturer of optical glass.

Full AF operation with the converters is possible with camera lenses with open aperture of F4 or brighter. Please be aware that AF will work properly only if there is enough light and contrast on the subject to activate the camera's AF sensors. (Manual focusing is recommended when using lenses with smaller open f-stop value than those given above.)

#### MC1.5 1.5x (4 elements in 4 groups)

Available for Canon EOS (KE1.5XCAF), Minolta Maxxum (KE1.5XMAF), Nikon AF-I & AF-D (KE1.5XNAF) and Pentax AF (KE1.5XPAF) ....**79.00**

#### MC4 2x (4 elements in 4 groups)

Available for Minolta Maxxum (KE2X4MAF), Canon EOS (KE2X4CAF), Pentax AF (KE2X4PAF), and Nikon AF-I & AF-D (KE2X4NAF) .....**89.00**

#### MC7 2x (7 elements in 5 groups)

Available for Minolta Maxxum (KE2X7MAF), Nikon AF-I & AF-D (KE2X7NAF), Canon EOS (KE2X7CAF) and Pentax AF (KE2X7PAF) ...**125.00**

### Kenko PRO 300 3.0x

Placed between the camera body and lens, a teleconverter contains a set of optics that will effectively increase the focal length of a lens by a specific amount. Common magnifications are 1.4 times and 2 times, but the Kenko Teleplus PRO 300 AF converter has a 3x magnification. For example, using a 3 times (3x) teleconverter will increase the focal of 300mm lens to 900mm.

The Teleplus PRO 300 AF converter is made with high quality multi-coated optical glass. It is designed for use with lenses of 50mm or above and work best with telephoto lenses of 100mm to 500mm.

The Teleplus PRO 300 AF converter has genuine Gate Array IC (Integrated Circuitry). This means that the converter's unique circuitry maintains signal integrity between the camera body and lens. These converters are designed to electronically operate the same way an original manufacturer's converter would provided there is enough light available.

Note: Due to the 3 stop light loss inherent in a 3x converter, the PRO 300 will not auto focus with lenses that have a smaller aperture than f/2.8. With all lenses having apertures smaller than f/2.8, Kenko recommends using the PRO 300 3x in manual focus mode.

**Pro 300 3x Teleconverter (KE3XP300CAF):** For Canon EOS.....**209.00**

**Pro 300 3x Teleconverter (KE3XP300NAF):** For Nikon AF-I & AF-D.....**209.00**

**Pro 300 3x Teleconverter (KE3XP300MAF):** For Minolta Maxxum .....**209.00**



### Kenko PRO 300 2.0x and 1.4x

Like the 3x, the Teleplus PRO 300 2x and 1.4x converters are made with precision quality multicoated optical glass supplied by Hoya Corporation—the worlds largest manufacturer of optical glass. These glass elements are designed to match the optical quality of the prime lens (even at the edges) and telephoto zoom lenses. The optical design of the elements and light path is wide enough not to cause vignetting.

They are designed specifically to be used with prime telephoto lenses of 100mm or above, such as the Tokina AT-X 300 AF PRO, 300 mm f/2.8 lens, and work best with telephoto lenses of 200mm to 500mm.

Like the 3x, the Teleplus PRO 300 2x and 1.4x converters also have genuine Gate Array IC (Integrated Circuitry). This means that the converter's own unique circuitry maintains signal integrity between the camera body and lens. These converters are designed to electronically operate the same way as an original manufacturer's converter.

Full AF operation with 2.0x is possible when using camera lenses with maximum aperture of F2.8 or brighter. Please be aware that AF will work properly only if there is enough light and contrast on the subject to activate the camera's AF sensors. (Manual focusing is required when using lenses with smaller maximum f-stop value than those given above).With the 1.4x, full AF operation is possible with camera lenses having a maximum aperture of F4 or brighter. The same light and contrast requirements apply.

**2x AF Pro 300 Teleconverter (KE2XP300CAF):** For Canon EOS.....**199.00**

**2x AF Pro 300 Teleconverter (KE2XP300NAF):** For Nikon AF-I & AF-D.....**199.00**

**2x AF Pro 300 Teleconverter (KE2XP300MAF):** For Minolta Maxxum .....**199.00**

**1.4x Teleplus Pro 300 Teleconverter (KE1.4XP300CA):** For Canon EOS .....**Call**

**1.4x Teleplus Pro 300 Teleconverter (KE1.4XP300NA):** For Nikon AF-I & AF-D .....**Call**

**1.4x Teleplus Pro 300 Teleconverter (KE1.4XP300MA):** For Minolta Maxxum .....**179.00**



**EQUIPMENT LEASING AVAILABLE**

# KENKO

## LENS ADAPTERS

### Teleplus Extension Tube Set

Extension tubes are designed to enable a lens to focus closer than its normal set minimum focusing distance. Getting closer has the effect of magnifying your subject. They are exceptionally useful for macro photography, enabling you to convert almost any lens into a macro lens at a fraction of the cost.



The tubes have no optics. They are mounted in between the camera body and lens to create more distance between the lens and film plane. By moving the lens father away from the film in the camera, the lens is forced to focus much closer than normal. The greater the length of the extension tube, the closer the lens can focus.

Kenko's Extension Tube Set contains three tubes (12mm, 20mm, and 36mm) which can be used individually or in any combination. They are designed with all the circuitry and mechanical coupling to maintain AF and TTL auto exposure.

#### Extension Tube Set

For Canon EOS (KEAETSCAF), Minolta Maxxum (KEAETSMAF), Nikon AF-D (KEAETSNAF) and Pentax AF (KEAETSAPAF) .....**129.00**

### UniPlus Tubes

UniPlus Tube (extension ring) is designed to shoot subjects at closer distance with higher magnification (1/2 for Tube 25 and 1/4 for Tube 12) with 50mm standard lens. Perfect coupling with automatic aperture, TTL metering and AE mechanism.

#### 12mm Autofocus Extension Tube

For Canon EOS (KEET12CAF), Minolta Maxxum (KEET12MAF), and Nikon AF-D (KEET12NAF) .....**59.00**

#### 25mm Autofocus Extension Tube

For Canon EOS (KEET25CAF), Minolta Maxxum (KEET25MAF), Nikon AF-D (KEET25NAF), and Pentax AF (KEET25PAF) .....**79.00**

## LENSPLUS LE-ADAPTER

### Lens to Eyepiece Adapter

With the LE Lens Adapter, you can now connect your SLR camera directly to the eyepiece of most telescopes, spotting scopes, microscopes, binoculars or monoculars for eyepiece projection photography with the unique patented and versatile LE-Adapter camera accessory.



Whether your interest is microscopy, astrophotography, bird watching, web authoring, surveillance, or just entertaining friends, the truly unique and fascinating images produced when using the LE-Adapter and magnification optics are now limited only by your imagination! The LE-Adapter opens a whole new area of photography and will greatly expand your camera capabilities. It's the accessory you've been searching for!

#### How does it work?

Simply thread the LE-Adapter onto the lens of your camera...set the three sizing screws to the approximate diameter of the Eyepiece. Insert the Eyepiece into the LE-Adapter and firmly tighten the sizing screws to lock the unit to the LE-Adapter.

**Standard LE-Adapter with 37mm/52mm Coupling Ring (LEALE37)**  
Couples eyepieces of various optical devices where the outside diameter of the respective eyepiece is 12mm to 41mm diameter .....**154.95**

**2-Plus/37mm LE-Adapter (LEALE237)**  
For much larger eyepieces like those found on Kowa, Leica, Swarovski spotting scopes or many telescopes. It will accept eyepieces where the outside diameter measures 35mm to 60mm .....**164.95**

## Lens Mount Adapters

|  |              |
|--|--------------|
| Minolta MD Lens on Minolta Maxxum Body (GBCAMAFM) .....          | <b>36.95</b> |
| Canon FD Lens on Minolta Maxxum Body (GBCAMAFD) .....            | <b>36.95</b> |
| Olympus Lens on Minolta Maxxum Body (GBCAMAFO) .....             | <b>36.95</b> |
| Pentax K Lens on Minolta Maxxum Body (GBCAMAFP) .....            | <b>36.95</b> |
| Nikon AI Lens on Minolta Maxxum Body (GBCAMAEN) .....            | <b>38.95</b> |
| Universal Lens (M42) on Minolta Maxxum Body (GBCAMAFU) .....     | <b>24.95</b> |
| Universal Lens (M42) on Minolta MD Body (GBCAMU) .....           | <b>18.95</b> |
| Universal Lens (M42) on Nikon AI Body (GBCANU) .....             | <b>27.95</b> |
| Pentax K Lens on Universal Screw-Mount Body (M42) (GBCAUP) ..... | <b>44.95</b> |
| Universal Lens (M42) on Contax/Yashica Body (GBCACYU) .....      | <b>14.95</b> |
| Universal Lens (M42) on Fujica-X Body (GBCAFU) .....             | <b>19.95</b> |
| Universal Lens (M42) on Konica SLR Body (GBCAKU) .....           | <b>16.95</b> |
| Universal Lens (M42) on Pentax K Body (GBCAPU) .....             | <b>14.95</b> |
| Universal Lens (M42) on Rollei SC Body (GBCARU) .....            | <b>16.95</b> |

# LEICA

## M7

### 35mm Manual Focus Rangefinder Camera

*Classics are works that clash with the present. They are never modified – instead they are re-interpreted on the basis of a changed world.*

*With the M7, a classic camera has been infused with modern electronic advantages that results in a camera that is faster than ever while still having the soul of a Leica. Convenience and fast operation of the camera have been enhanced with aperture-priority autoexposure, an informative viewfinder, high-speed flash synchronization and more.*

*Not just the functions themselves are revolutionary, but their seamless integration into the classic Leica M camera concept. The Leica cloth focal plane shutter – with its vibration-free and quiet action is now controlled electronically. However, form, size and the proven operating concept are unchanged. Virtually all system components of the preceding models (M6, M6 TTL) remain compatible. Photography with the M7 is a surprisingly new and yet unchanged experience.*



#### FEATURES

##### Range-finder System

The range-viewfinder system is an optical masterpiece, created for photographic work at the highest level. Unlike a reflex system, in which the focal length and the light intensity affect the measurement, the measuring base of the rangefinder in the M7 always remains the same, regardless of the lens being used. That is why its accuracy with short focal length lenses is many times more accurate. In addition, a special method of distance measuring guarantees fast, accurate and razor-sharp focusing, even under extremely poor light conditions.

In order to enhance contrast and brightness even further, an especially scratch-resistant multi-coating is applied to the viewfinder windows. All the other information that is relevant for a perfect result, as well as the surroundings of the subject is visible in the bright-line viewfinder – ideal prerequisites for spontaneous, inconspicuous photography. There are three viewfinder magnifications to choose from: The wide-angle and eyeglass wearer version of 0.58x, the universal magnification of 0.72x and the tele variant of 0.85x.



##### Viewfinder

33 display items within an area of just 0.7 x 2.3mm constitute a masterful achievement that is unique in a rangefinder camera. Especially because the readings are displayed at 15x magnification, so that the photographer has an optimal overview of all the information he needs for a good exposure at a single glance. The automatically generated shutter speed is indicated by an LED display at the bottom of the large and bright viewfinder image. For long exposure times, the viewfinder display shows the time that remains. In the "B" time exposure mode, the display counts the elapsed seconds upwards. The brightness of the display adjusts itself automatically to the prevailing subject brightness, assuring the best visibility even in bright sunlight, and in available light situations it prevents the display from blinding the observer.

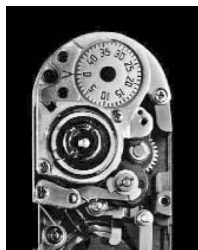

##### Durable and Reliable

The mechanisms are unsurpassed in terms of precision and dependability. High grade materials are used exclusively. The top plate of the M7 is milled from a solid block of brass by a modern process. The main body and the housing are made of lightweight but extremely rugged die-cast aluminum. The M7 works quickly, easily and above all, quietly – it has no noisy hinged mirrors and spring-loaded automatic diaphragms. Therefore the sound of the shutter release is significantly more quiet than the familiar clatter of single-lens-reflex cameras. The chrome-plated rapid-change bayonet and the few knobs and switches are equally robust and long-lived. They are positioned so conveniently and designed so ergonomically that they can even be operated while wearing gloves. With their palpable marking, Leica lenses can also be changed in the dark. They can be placed on a surface without their protective back covers because there are no protruding pins and levers that could be damaged.

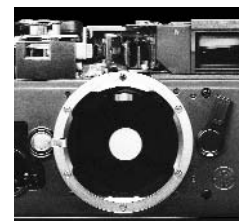

For Any Inquiries Regarding Your Order, Call Our Customer Service:  
(800) 221-5743 • (212) 239-7765 • FAX: (800) 947-2215 • (212) 239-7549

# LEICA

## M7

### Exposure Metering

Backlighting, sports illumination or laterally grazing light results in different colors, brightness and contrasts. A challenge that the M7 meets without difficulties. Its selective TTL exposure metering is activated by a slight pressure on the shutter release button. This selective exposure metering works absolutely precisely and thanks to its high sensitivity, it can even be used in candle-light. In conjunction with the stepless automatic shutter speed control, perfectly exposed images are possible under all conditions without any problems.

### Aperture Priority Exposure

In addition to the familiar manual exposure settings, the M7 features a stepless automatic shutter speed control – once the f-stop has been selected on the lens, the camera's electronics automatically determine the ideal shutter speed for the correct exposure, even for long exposure times of up to 30 seconds. Plus, with the exposure value storage at the release button, the desired exposure can be retained for a particular part of the subject. Also offers  $\pm 2EV$  exposure compensation.

### The Shutter

The unique cloth focal plane shutter of the Leica M is legendary. And while retaining all its advantages, the M7 incorporates the electronic control of the exposure times. Two mechanically controlled shutter speeds of 1/60 second and 1/125 second guarantee the functionality of the M7 even when the batteries are dead. Furthermore, the shutter release cycle is extremely quiet, fast and vibration-free. The exposure delay amounts to a mere 25 milliseconds in spite of the electronic control and thus it is nearly ten times faster than that of a conventional autofocus single-lens-reflex camera.

CAMERAS & LENSES

55

*With the LEICA M7, you can choose between three viewfinder magnifications: the standard 0.72x, an 0.85x viewfinder magnification for longer focal lengths, and an 0.58x viewfinder magnification for wide-angle photography.*

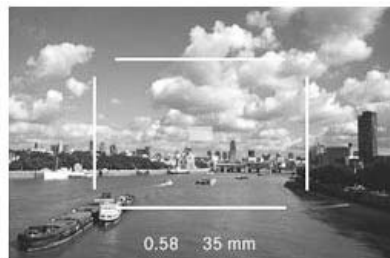

*0.58x viewfinder magnification for people who wear spectacles and for wide angle photography*

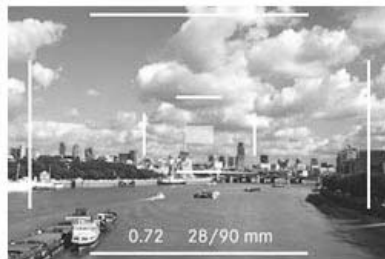
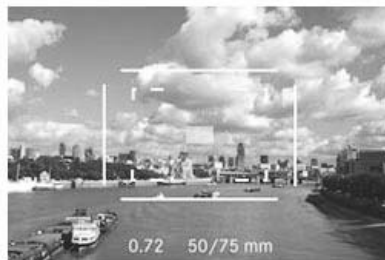

*0.72x viewfinder magnification for universal use*

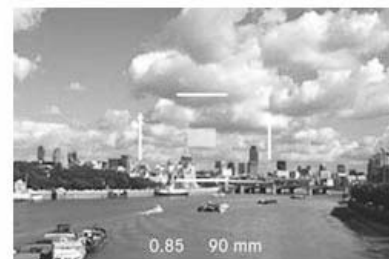
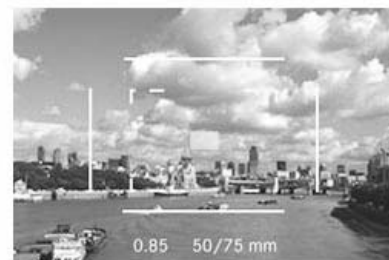
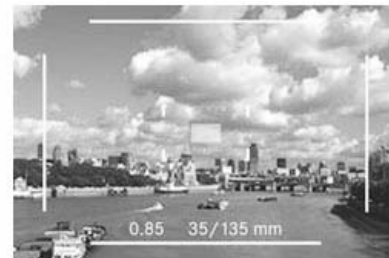

*0.85x viewfinder magnification for longer focal lengths*

**ORDER & INFO. (212) 502-6340 • FAX: (212) 239-7770 (800) 947-7008  
1-800-290-6750 • [www.bhphotovideo.com](http://www.bhphotovideo.com)**



# LEICA

## M7

### DX Coding & On/Off Switch

- ◆ The M7 automatically sets the film speed, or you can set the film speed manually. The film speed is automatically displayed in the viewfinder during the first two seconds after the camera is switched on.
- ◆ The separate On/Off switch, for ergonomic reasons, is positioned right next to the shutter release button and serves to activate the camera's electronics. The OFF setting blocks the shutter release.

### Flash Sync and Second Curtain Sync

With a sync time of up to 1/1000 second, the M7 makes it easy to apply a properly balanced fill-in flash in many daylight situations. When you want your pictures to convey a truly natural impression, like the impression created by a time exposure with fill-in flash, for instance, the M7 can be set to trigger the flash with the second shutter curtain.

### M7 Bodies and Kits

All M7 bodies include a neck strap, body cap, two 3v lithium batteries, 5-year limited warranty and Leica 3-year Passport warranty.

#### "50 Year M System"

##### Special Edition Set (LEM7K)

Includes M7 TTL .72 titanium body, 50mm f/1.4 Summilux M ASPH titanium lens, leather neck strap, black cloth-bound velvet-lined storage box, leather lens pouch, "50 Years of Leica M" book.....**10,800.00**

##### M7 "Starter Set" (LEM7SS)

Includes M7 TTL .72 black body, 50mm f/2.0 Summicron M lens .....**3795.00**

##### M7 TTL .58 Black Body (LEM7TTL.58B)

0.58x viewfinder magnification .....**2895.00**

##### M7 TTL .72 Black Body (LEM7TTL.72B)

0.58x viewfinder magnification .....**2895.00**

##### M7 TTL .85 Black Body (LEM7TTL.85B)

0.58x viewfinder magnification .....**2895.00**

##### M7 TTL .58 Silver Body (LEM7TTL.58S)

0.58x viewfinder magnification .....**2895.00**

##### M7 TTL .72 SilverBody (LEM7TTL.72S)

0.58x viewfinder magnification .....**2895.00**

##### M7 TTL .85 Silver Body (LEM7TTL.85S)

0.58x viewfinder magnification .....**2895.00**

## M7 SPECIFICATIONS

|                                    |   |
|------------------------------------|---|
| <b>Camera Type</b>                 | Compact 35mm rangefinder system camera with electronically controlled shutter plus two mechanically controlled shutter speeds.  |
| <b>Lenses</b>                      | Leica M lenses with focal lengths from 21 to 135mm  |
| <b>Viewfinder</b>                  | Large, bright combined range- and viewfinder with bright-line frames and automatic parallax compensation. Eyepiece corrected for -0.5 diopter. Correction lenses from ±3 diopters are available.<br><br>Bright-line frames are activated in pairs : 28 and 90mm (90mm by itself in the M7 0.85), 35 and 135mm (35mm by itself in the M7 0.58), and 50 and 75 mm. The respective bright-line frames are activated automatically when a lens is locked in place. Any desired frame can be previewed by means of the preview lever.  |
| <b>Large Base Rangefinder</b>      | Split-image and coincident-image rangefinder within a bright field in the center of the viewfinder image.   |
| <b>Effective Measurement Base</b>  | M7 0.58: 40.2mm;<br>M7 0.72: 49.9mm;<br>M7 0.85: 58.9 mm  |
| <b>Exposure Metering</b>           | Selective through-the-lens (TTL) exposure metering at working aperture. Center-weighted integral TTL metering for flash exposures with dedicated SCA 3000 standard flash units.   |
| <b>Film Speed Range</b>            | Choice of automatic film speed setting with DX-coded film cartridges from ISO 25 to ISO 5000 or manual setting from ISO 6 to ISO 25000. By means of the exposure override (± 2 EV), films with speeds ranging from ISO 1.5/3° to ISO 25000/45° can be used.   |
| <b>Exposure Modes</b>              | Choice of automatic control of the shutter speed – with corresponding viewfinder display – at a pre-selected f-stop (aperture-priority, or manual setting of shutter speed and f-stop in accordance with the LED light balance in the viewfinder.   |
| <b>Flash Exposure Control</b>      | <b>Synchronization:</b> Can be triggered by the first or the second shutter curtain (with an appropriate flash unit and a SCA-3502 Adapter). <b>Flash synch speed:</b> 1/50 second, set automatically in the AUTO mode; slower shutter speeds can be used with manual settings; faster shutter speeds (1/250, 1/500, 1/1000) can be used with manual settings if the flash unit being used offers the "High Speed Synchronization" function with an SCA-3502 Adapter. Flash exposure metering (with an SCA-3501/3502 Adapter, or a standard SCA-3000 flash unit such as the LEICA SF20) TTL control with center-weighted integral metering. Film speed range for TTL flash exposure metering ISO 12/12° to ISO 3200/36°. <b>Displays when flash is being used:</b> Readiness: The flash symbol LED in the viewfinder remains lit. Flash confirmation : The LED remains lit or it temporarily blinks rapidly after the exposure. Under-exposure is indicated by a temporary extinction of the LED. |
| <b>Shutter and Shutter Release</b> | <b>Shutter:</b> Horizontally running, rubberized cloth focal plane shutter. Extremely quiet. Controlled electronically, plus two mechanically-set shutter speeds : 1/60 s and 1/125 s. <b>Shutter speeds:</b> stepless from 32 to 1/1000 in the 'AUTO' automatic shutter speed control mode. In the manual mode, from 4 to 1/1000 in full steps, plus 'B' for time exposures of any length. Flash synch speed 1/50. <b>Shutter release:</b> Three stages: energizing – metered exposure value storage – release. Release button has an integrated thread for standard cable releases.   |
| <b>Film Transport</b>              | <b>Advancing:</b> Manually with quick wind lever or motorized using LEICA MOTOR-M. <b>Rewinding:</b> Manually with rewind lever after turning the lever to "R" on the front of the camera. <b>Frame counter:</b> On the top of the camera. Resets automatically on removal of base plate.   |
| <b>Camera Body</b>                 | All-metal body with foldable rear panel. Brass top plate and base plate, both chromium plated in black or silver  |
| <b>Operating Voltage</b>           | 6v power supply (2 lithium cells, type "DL 1/3 N"). Battery check shown by flashing of the LEDs in the digital display or the light balance or by illumination of the display "bc" or the LEDs going out.   |



EQUIPMENT LEASING AVAILABLE

### 35mm Manual Focus Rangefinder Camera

*Mechanical perfection. Nothing else. The Leica MP is a tool. Made by hand, created for the photographer's craft. Tailored to the decisive photographic parameters. In compact form, with clean design, clearly laid out. Unobtrusive, quiet, reliable. Concentrated technology for concentrated photography, without distraction by automation. For pictures that only a photographer can see, compose and record. Modern, because it captures the present. Current, because all its features have been optimized. Traditional, because it builds on the accumulated experiences of the pioneer in 35mm camera construction. Not a photographic whim, but a camera for life.*



#### FEATURES

- ◆ The MP is the purely mechanical alternative to the M7, whose electronically controlled shutter and aperture priority automatic exposure control offer more convenience and functions. The MP is dependent upon the skill of the photographer, but independent of, for instance, batteries. The latter are only needed for exposure metering. Those who set shutter speeds and apertures themselves can dispense with the electronics altogether.
- ◆ All control elements are made completely of metal. The pull-up rewind knob is especially handy and impact-resistant.
- ◆ Tailored ideally to the preferences and needs of the photographer, the MP is available with the three viewfinder magnifications of 0.58x, 0.72x, and 0.85x: 0.58x magnification for a great overview with wide-angle lenses and for eyeglass wearers. 0.72x as a universal standard. 0.85x for accurate focusing with medium focal length and telephoto lenses.
- ◆ Photography means writing with light. Photography with the MP also means being able to create dramatic images even in low light situations. Lenses that deliver rich contrast and full performance at full aperture; focusing with pinpoint accuracy with the Leica rangefinder; and the vibration-free release of the cloth focal plane shutter are the basis for that capability.
- ◆ The MP has been designed for longevity and value retention. To that end, Leica uses only selected materials and sophisticated fabrication processes. Before it was ready to be marketed, the MP was subjected to numerous and exhaustive field- and laboratory tests to prove its solidity. In extremely cold temperatures, in which no battery-dependent camera would function any longer. With shutter release cycles in numbers that hardly any other camera can sustain. That's why Leica can offer an unusually long 5-year warranty period.
- ◆ Difficult light situations can be mastered accurately with the MP, because the camera does not attempt to think on behalf of the photographer. Instead, its selective exposure metering provides the photographer with accurate, unequivocal data on which he can base his decisions. The MP goes one step further with a newly improved viewfinder: A new type of mirror and an additional lens element present a measuring field rich in contrast and clearly delineated bright-line frames for the various focal lengths, even with particularly critical lateral light.
- ◆ The MP is available in two finishes: silver chrome and black lacquer. And when, after long and intensive use, the black lacquer wears down to the bare brass on some edges and corners, you'll know that you shared many experiences with the camera.



#### MP Hammertone (LHSA)

The special edition MP LHSA model was commissioned by the Leica Historical Society of America (LHSA) on the occasion of their 35th birthday. Its surface finishing evokes the style of 1960s machinery and tools: top plate and base plate are given a grey Hammertone finish.

#### MP Hermes Edition

The MP Hermes Edition is a special edition of 500 silver-chrome MP cameras covered with exquisite Barenia calfskin supplied by Hermès. The processing of Barenia leather, which has a very fine, natural grain, gives it its unmistakable luxurious "feel". The naturally brown leather harmonizes particularly well with the silver chrome finish of the camera. In addition to a 35mm f/2 Summicron-M ASPH lens that is also finished in silver chrome, this special edition includes a handcrafted camera strap using the same exquisite Barenia leather. The lens hood, the camera body cover as well as the front- and rear covers of the lens are made of solid brass and they too, are finished in silver chrome. Special serial numbers from 001/500 to 500/500 are engraved on the lens and on the camera. Shipped in a textile-covered box, which is lined with pure silk.



# LEICA

## M LENSES

CAMERAS & LENSES

58

The extreme importance that Leica dedicates to the highest quality of its products can be verified on every individual lens. Optical glasses are prepared to special formulations and grounded, polished and ultimately centered with extremely meticulous craftsmanship. The result, convenient, compact precision optics, unique in themselves that are always designed to meet the needs of practical photography. And extraordinarily long-lived too. All Leica M lenses are compatible with every M cameras of the past, present and future. There is more. The judicious policy of preserving compatibility even allows lenses from the 1930's to be used on highly modern Leica cameras. Every new lens is supplied with a high-grade soft nappa leather case and a lens hood that is specifically designed for that lens.

At Leica, each lens is a masterpiece. Aspherical lens elements (ASPH) are used for further enhancement of the imaging performance. They have a surface that deviates from the spherical shape and they are very complex to produce, but they produce the very best results with a compact design. Apochromatic correction (APO) is used by Leica on telephoto lenses in order to combine the color spectrum coming from a point on the subject practically into a point on the image. This assures the highest sharpness across the entire image, even at full aperture.



### WIDE-ANGLE LENSES



21mm f/2.8 Elmarit-M ASPH

24mm f/2.8 Elmarit-M ASPH and 28mm f/2.8 Elmarit-M

#### **21mm f/2.8 Elmarit-M ASPH (LE2128AM)**

Uniform sharpness and low distortion across the entire image area, even at full aperture, distinguish this lens. This is achieved with, among other factors, a lens element with an aspherical surface. Optimal for dramatic effects with monumental foreground, strongly receding background and a wide horizon. With this lens, focusing and exposure metering are performed by looking into the camera's viewfinder, whereas the actual field coverage is checked by means of an accessory brilliant viewfinder. Available in black anodized or silver chrome finish.....**2895.00**

#### **24mm f/2.8 Elmarit-M ASPH (LE2428AM)**

This lens establishes new standards for wide-angle lenses with regard to contrast and detail rendition at full aperture. This special lens design combines one aspherical lens surface, one lens element with anomalous partial dispersion and two other lens elements made of optical glasses with high indices of refraction to give this compact unit outstanding contrast—and detail rendition— even at full aperture. This focal length is often ideal for dynamic close-ups or for landscape photographs with great depth. High brilliance and dimensional effect, even in the close-up range. Available in black anodized or silver chrome finish.....**2395.00**

#### **28mm f/2 Summicron-M ASPH (LE282M)**

Very fast wide-angle lens recommended for reporting and available light photography such as twilight or in dimly lit interiors. Uncompromised image quality, even at full aperture. Thanks to a sophisticated optical formula, in which special types of glass and an aspherical surface were used, the dimensions and the weight are almost identical to the 28mm f/2.8 even though it is one stop faster .....**2595.00**

#### **28mm f/2.8 Elmarit-M (LE2828M)**

Because of its impressive rendering of fine details and contrasts, this lens is the preferred choice for photographs in tight quarters and for landscape and architectural photography. In order to make the frame visible, a bright-line frame is displayed in the viewfinder of the M7 0.58 or 0.72. With the M7 0.85, an accessory brilliant viewfinder is required.....**2095.00**



# LEICA

## M LENSES

### WIDE-ANGLE and STANDARD LENSES

#### **35mm f/1.4 Summilux-M** (LE3514Am)

The focal length makes it an all-around versatile lens—yet its high-speed makes it an exceptional lens. A wide-angle lens with very high speed and rich contrast rendition and an imaging performance at full aperture that is unique in compact 35mm lenses. The complex optical design with an aspherical lens surface produces an image quality at full aperture that is unique for compact wide-angle lenses. Available in black anodized or silver chrome finish.....2795.00

#### **35mm f/2 Summicron-M ASPH** (LE352AM)

With superb sharpness, excellent contrast and outstanding resolving power across the entire focusing range, this versatile all-around lens is one of the world's top high-speed wide-angle lenses. Equipped with the 35mm f/2, a Leica M body becomes an elegant compact camera. Available in black anodized or silver chrome finish.....1895.00

#### **50mm f/1.0 Noctilux-M** (LE501M)

The world's first f/1.0 lens for 35mm cameras manufactured in series by Leica. A 'giant light-gatherer' with its outstanding optical performance, it produces night photographs with excellent contrast without flash – even by candlelight! It produces outstanding contrast rendition, so that barely noticeable color differences are faithfully separated and the finest structures of the subject are resolved accurately, even under unfavorable light conditions.....3295.00



#### **50mm f/1.4 Summilux-M** (LE5014M)

An extremely fast standard lens, the 50mm f1.4 is the favorite of many reportage photographers. Sharpness and contrast are outstanding at full aperture. Its extraordinary speed of f1/4 permits short shutter speeds even in poor lighting conditions. The lens also has remarkably neutral color rendition and exact color differentiation. Available in black anodized or silver chrome finish.....1895.00

#### **50mm f/2.0 Summicron-M** (LE502M)

This legendary and handy universal lens is certainly one of the very best among fast standard lenses. Its image quality is outstanding, even at closest focusing distances. With a built-in sliding lens hood. Available in black anodized or silver chrome finish.....1295.00

#### **50mm f/2.8 Elmar-M** (LE5028M)

This is the lens of choice when compact size and light weight are more important than the highest speed. The lens barrel can collapse into the camera body, making your M7 or MP extra handy. The utilization of optical glasses with high indices of refraction and a new optical computation produce an overall outstanding performance. Available in black anodized or silver chrome finish.....795.00

# LEICA

## M LENSES

### TELEPHOTO LENSES



75mm f/1.4 Summilux-M

90mm f/2 APO Summicron-M ASPH

90mm f/2.8 Elmarit-M

90mm f/4 Macro-Elmarit-M

135mm f/3.4 APO Telyt-M

#### 75mm f/1.4 Summilux-M (LE7514M)

A fast lens with unique capabilities. The flare-free and unexcelled subtleties of its color rendition are the result of a meticulous optical computation and unique optical glass. Systemic vignetting is remarkably low for a lens of this speed, and distortion is practically undetectable. Its high speed of f/1.4 is ideal for available light photography, especially natural portraits. Ideal for difficult, high-contrast situations, such as at concerts or stage performances. Has a built-in sliding lens hood.....**2995.00**

#### 90mm f/2 APO Summicron-M ASPH (LE902AM)

A lens that is practically unequaled in its class. Its high speed permits relatively fast shutter speeds, which, among other things, help to prevent blurs in quick inconspicuous snapshots taken at a distance. With an aspherical lens surface and APO-corrected quality, this lens sets the standard for portraits and photojournalism. Has built-in sliding lens hoods. Available in anodized black or silver chrome finish .....**2295.00**

#### 90mm f/2.8 Elmarit-M (LE9028M)

Very good contrast and sharpness, even at full aperture, make this compact universal lens that only weighs 14 oz. an ideal companion on the road. Only slightly bigger than a 50mm lens. Has built-in sliding lens hoods. Available in anodized black or silver chrome finish .....**1445.00**

#### 90mm f/4 Macro-Elmarit-M (LE904M)

The 90mm f/4 Macro is a high performance lens, ideal for portraits, travel or photojournalism. When combined with the dedicated Macro Adapter, the lens has a reproduction ratio of 1:3. Weighing less than 1 lb. and only 1.6" when collapsed, the 90mm f/4 Macro is first choice whenever you wish to limit your outfit to a minimum without forfeiting the maximum in image quality. Includes clip-on, reversible metal lens hood and soft, padded leather case. Available in anodized black or silver chrome finish.....**1295.00**

#### 135mm f/3.4 APO Telyt-M (LE13534AM)

Remarkable in all aspects, this telephoto lens has outstanding Leica APO qualities in terms of perfect resolving power, contrast and sharpness at all apertures. Other plus points are its low weight and ease of use. Comes with a built-in sliding lens hood .....**2295.00**

#### Macro-Adapter-M (LEAM)

Designed specifically for the 90mm f/4 Macro, the Macro-Adapter M allows the lens to close focus from 2.5-ft. (1:6 life-size ratio) down to 1.6-ft. (1:3 life-size ratio). When the lens is to be used in its close-focusing range from 0.77 to 0.5m, the Macro-Adapter-M is attached to the camera body instead of the lens. The lens is then mounted on the adapter after rotating it 180°, i.e. with its lower side turned up. In this position, a second pair of distance and depth of field scales for the respective focusing range becomes visible, enabling easy reading from above. Includes a practical leather case featuring a belt loop .....**844.95**



# LEICA

## M LENSES



CAMERAS & LENSES

61

### **Tri-Elmar-M 28-35-50mm f/4 ASPH** (LE2835504MB)

With the versatile Tri-Elmar-M, Leica combines the M-photographer's three most popular focal lengths, 28, 35 and 50mm, into a single, extremely compact lens—while retaining the high optical performance typical of Leica. Completely redesigned and more reliable and easier to use than ever. A shaped handle on the distance setting ring makes focusing easier and a scale on the lens displays the depth of field for all three focal lengths. Filter diameter is reduced to only 49mm for a better viewfinder image. The optimized zoom ring engages audibly and tangibly at every focal length now, thus preventing accidental readjustment of the focal length. A metal lens hood is available as an accessory that does not obstruct the viewfinder image. Using an adapter, a 67mm circular polarizer can be used that is set directly through the viewfinder. A matching 49mm UVA "slim filter" that prevents vignetting at 28mm is also available.

#### **High Optical Performance:**

Designed and manufactured in Germany, the lens comprises 8 lenses in 6 groups. In order to guarantee maximum optical performance for such a compact lens, two aspherical lenses were used. Furthermore, 5 lenses in the complex optical system are made of especially high refracting glass. The lens is characterized by good to very good performance at all three focal lengths. Even when completely open, a high-contrast image with good detail resolution is achieved. The contrast can even be increased by stopping down at f/5.6. Because the performance is already good with maximum opening, the critical f-stop with this lens is between f-stop 5.6 and 8. At all three focal lengths, field curvature has been reduced to a minimum so that it is not visible in practice. At 35mm and 50mm, vignetting is similarly low to that of the Leica M fixed focal lengths. Only at 28mm is vignetting slightly stronger. Above f/8 all three focal lengths of the lens are free of artificial vignetting .....2895.00

| Lens Designation                      | Focal Length/Speed in mm | Angle of View | Lens Elements/Groups | Smallest Aperture | Filter Size | Length in mm | Weight in grams |
|---------------------------------------|--------------------------|---------------|----------------------|-------------------|-------------|--------------|-----------------|
| ELMARIT-M ASPH                        | 21 f/2.8                 | 92°           | 9/7                  | 16                | 55          | 46           | 300             |
| ELMARIT-M ASPH silver chrome finish   | 21 f/2.8                 | 92°           | 9/7                  | 16                | E55         | 46           | 414             |
| ELMARIT-M ASPH                        | 24 f/2.8                 | 84°           | 7/5                  | 16                | E55         | 45           | 290             |
| ELMARIT-M ASPH silver chrome finish   | 24 f/2.8                 | 84°           | 7/5                  | 16                | E55         | 45           | 388             |
| SUMMICRON-M ASPH                      | 28 f/2                   | 76°           | 9/6                  | 16                | E46         | 41           | 270             |
| ELMARIT-M                             | 28 f/2.8                 | 76°           | 8/7                  | 22                | E46         | 41.4         | 260             |
| SUMMILUX-M ASPH                       | 35 f/1.4                 | 64°           | 9/5                  | 16                | E46         | 46.2         | 310             |
| SUMMILUX-M ASPH silver chrome finish  | 35 f/1.4                 | 64°           | 9/5                  | 16                | E46         | 46.2         | 415             |
| SUMMICRON-M ASPH                      | 35 f/2                   | 64°           | 7/5                  | 16                | E39         | 34.5         | 255             |
| SUMMICRON-M ASPH silver chrome finish | 35 f/2                   | 64°           | 7/5                  | 16                | E39         | 34.5         | 340             |
| TRI-ELMAR-M ASPH                      | 28-35-50 f/4             | 64°-64°-44°   | 8/6                  | 22                | E55         | 67.8         | 340             |
| NOCTILUX-M                            | 50 f/1                   | 45°           | 7/6                  | 16                | E60         | 62           | 630             |
| SUMMILUX-M                            | 50 f/1.4                 | 45°           | 7/5                  | 16                | E46         | 46.7         | 275             |
| SUMMILUX-M silver chrome finish       | 50 f/1.4                 | 45°           | 7/5                  | 16                | E46         | 46.7         | 380             |
| SUMMICRON-M                           | 50 f/2                   | 45°           | 6/4                  | 16                | E39         | 43.5         | 240             |
| SUMMICRON-M silver chrome finish      | 50 f/2                   | 45°           | 6/4                  | 16                | E39         | 43.5         | 335             |
| ELMAR-M                               | 50 f/2.8                 | 45°           | 4/3                  | 16                | E39         | 37.6         | 170             |
| ELMAR-M silver chrome finish          | 50 f/2.8                 | 45°           | 4/3                  | 16                | E39         | 37.6         | 245             |
| SUMMILUX-M                            | 75 f/1.4                 | 31°           | 7/5                  | 16                | E60         | 80           | 560             |
| APO SUMMICRON-M ASPH                  | 90 f/2                   | 27°           | 5/5                  | 16                | E55         | 78           | 500             |
| ELMARIT-M                             | 90 f/2.8                 | 27°           | 4/4                  | 22                | E46         | 76           | 410             |
| ELMARIT-M silver chrome finish        | 90 f/2.8                 | 27°           | 4/4                  | 22                | E46         | 76           | 560             |
| APO-TELYT-M                           | 135 f/3.4                | 18°           | 5/4                  | 22                | E49         | 105          | 460             |

**ORDER & INFO. (212) 502-6340 • FAX: (212) 239-7770 (800) 947-7008  
1-800-290-6750 • www.bhphotovideo.com**



# LEICA

## M7 & MP ACCESSORIES

CAMERAS & LENSES

62



### Motor M (LEWM)

An especially compact and quiet motor drive for the Leica M7, the Motor M allows you to shoot up to 3 fps (frames per second). It's motor and gear train are especially designed for quiet operation. In fact, you can shoot at 1.5 fps practically unnoticed. The exceptionally good handling of the camera, lens and Motor M form a harmoniously balanced unit. On the rear of the Motor M there is an on/off switch with two speed settings (1.5 and 3 fps). Two lithium 123A batteries are housed in the ergonomic handle, which is covered with grained PVC. The battery compartment is equipped with a cover that cannot be lost and with a lock to protect against accidental opening. The Motor M continues the shape of the main body of the M7 and increases the height of the camera winder unit by only 18.5mm.....**845.00**

### SF24D TTL Flash (LESF24D)

A compact and lightweight flash with a handsome Leica design, the SF24D is easy to carry and simple to operate. It allows TTL-flash exposure control with the M6 or M7 (as well as R8/R9). It features an illuminated LCD display and variable flash output — useful, for instance, for pictures that benefit from fill-in flash. Powered by two 3v lithium batteries for high performance and fast recycling. The relatively large distance between the optical axis of the M lens and the flash tube reduces the danger of the “red-eye effect”. Flash switches off automatically when not in use for more than 3 minutes. Includes 24mm wide angle and 85mm telephoto diffusers and a velvet pouch. Available in titanium or black.....**249.95**



### Viewfinder for 24mm M-Lens (LEVF24)

Bright-line frame finder for M 24mm lenses. Parallax compensation markings below 2m. Includes case.....**319.95**

### Viewfinder for 28mm M-Lens

Bright-line frame finder for M 28mm lenses. Parallax compensation markings below 2m. Includes case.



Handgrip M

### Handgrip M (LEGM)

For secure and comfortable holding of the M7 wherever you are. With a centered tripod socket.....**103.50**

### Viewfinder for 21/24/28mm Lenses (LEVF)

The Viewfinder for 21/24/28mm lenses combines high optical performance with practical handling, as the selection of framing for all three focal lengths can be carried out without changing the viewfinder. Robust all-metal construction for professional use. Available in black or silver finish.....**369.95**

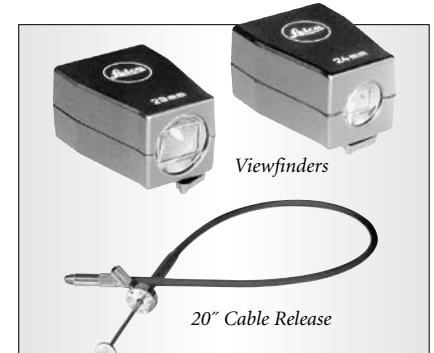

Viewfinders

20" Cable Release

### 20" Cable Release (LECR20R)

Mechanical cable release with set-screw lock for time exposures..... **28.95**

### VF Magnifier M 1.25x (LEVFM)

A small and practical accessory for M Series cameras, the VF Magnifier M 1.25x enlarges the viewfinder image by twenty-five percent, facilitating image composition when using lenses with focal lengths of 50mm or longer. At the same time, it also improves focusing accuracy by expanding the effective measuring base.

The wide-angle version of the M7 with 0.58x viewfinder magnification produces 0.72x magnification when the magnifier is used and is therefore suitable for longer focal lengths as well. With the 0.72x version, an 0.9x viewfinder magnification is obtained. And the 0.85x version, which is already geared to longer focal lengths, has a 1.06x magnification with the viewing magnifier. Made of black anodized aluminum, the viewing magnifier is screwed into the camera eyepiece. It also has a thread for correction lenses to compensate for vision defects.....**229.00**



### Diopter Lenses for MP/M7

- +0.5 Diopter (LEDP.5M) .....72.95
- +1 Diopter (LEDP1M).....72.95
- +1.5 Diopter (LEDP1.5M).....72.95
- +2.0 Diopter (LEDP2M).....72.95
- +3.0 Diopter (LEDP3M).....72.95
- 0.5 Diopter (LEDM.5M).....72.95
- 1.0 Diopter (LEDM1M) .....72.95
- 1.5 Diopter (LEDM1.5M).....72.95
- 2.0 Diopter (LEDM2M) .....72.95
- 3.0 Diopter (LEDM3M) .....72.95



**ONE HOUR FREE PARKING**  
AT 349 W. 34th STREET (with purchase of \$100 or more)

## M7 & MP ACCESSORIES

### MP Rapid Film Rewind Crank

The rewind crank is an accessory for fast and convenient rewinding of the film. The crank gets attached to the rewinding knob by means of a small screw. Includes a small screwdriver.



Silver Crank (LERCMPS) .....179.00  
Black Crank (LERCMPB) .....179.00

### Leicavit-M Rapid Manual Film Advance Winder



The Leicavit M is a compact, manual quick-wind device for the MP and M7. Attaching the Leicavit M only increases the height of the camera by 9.1mm, and only adds 5oz. to the weight. It allows the film to be advanced quickly and comfortably without having to take the camera away from your eye.

Silver Winder (LELVS) .....995.00  
Black Winder (LELVB) .....995.00



### Ever-Ready Case M (LECM6Z)

With standard front for Leica M7 (without winder). Holds an M7 with an attached 21mm, 24mm, 28mm, 35mm, any 50mm lens .....159.95

### Ever-Ready Case MP (LECMP)

With a large front for Leica M7 (without winder). Holds an M7 with an attached 21mm, 24mm, 28mm, 35mm, 50mm or 28-35-50mm lens .....239.95

### Lens Hoods for M Lenses



Lens Hood for 21mm f/2.8, 24mm f/2.8 and 28-35-50mm f/4.0 M-Lenses (LELH24M)  
Replacement for 21mm and 24mm lenses only .....108.50

Lens Hood for 28mm f/2.0 M Lens (LELH282M) .....99.95

Lens Hood for 35mm f/1.4 M Lens (LELH35MY)  
Replacement .....79.95

Lens Hood for 35mm f/2.0 M Lens (LELH35MQ3)  
Replacement .....68.50

Lens Hood for 50mm f/2.8 Chrome M Lens (LELH50MY)  
Replacement .....54.50

Lens Hood for 50mm f/2.8 Black M Lens (LELH50BMZ)  
Replacement .....54.50

Lens Hood for 28-35-50mm M Lens (LELH2835504M) ..139.00

### Large Ball and Socket Head (LEBSHL)

Hold nearly any 35mm camera/lens combination. 1/4-20" standard camera attachment screw. Great for use with the Leica tabletop tripod. It features a ridged ball for precise feel and positioning capacity. Supports 5.5 lb.....168.95



### Table Tripod (LETT)

Compact, practical and stable, the Table Tripod is an indispensable support for long exposure time. With three legs (the legs rotate together to make it flat for storage) and standard 1/4-20" top screw thread. Ideal for use with the Large Ball & Socket Head..... 91.95



### Lens Carrier M (LELCM)



A clever way to have a second lens ready without having to take an extra camera case along. It attaches to the baseplate of the camera and accepts one M-mount lens ..... 179.00

### Filters for LEICA M and R Lenses

|  |   |
|--|---|
| Series 5.5 ND 1x (LEND1S5.5) .....119.95   | E49 UVa (LEUV49) .....79.95   |
| Series 5.5 Filter Holder for 280mm and 400mm R lenses (LEFH400) .....237.95          | E49 UVa for 28-35-50/4.0 ASPH (LEUV49E) .....93.50                      |
| Series 5.5 Circular Polarizer for 280mm, 400mm f/2.8 R Lenses (LECP400R) .....363.95 | E55 UVa (LEUV55) .....84.95   |
| Series 6 Filter Holder for 280/400/560mm, 400/560/800mm (LEFHS6) .....248.50         | Silver E55 UVa (LEUV55S) .....95.95                                     |
| Series 6 UVa (LEUVS6) .....64.95   | 55E Circular Polarizer (LECP55Q) .....239.95                            |
| Series 6 Circular Polarizer (LECP56) .....389.95                                     | E60 UVa (LEUV60E) .....89.95  |
| Series 6 ND 1x (LEND1S6) .....136.95   | 60E Circular Polarizer (LECP60EQ) .....259.95                           |
| Series 8 UVa (LEUVS8) .....94.95   | E67 UVa (LEUV67) .....99.95   |
| Series 8 Circular Polarizer (LECP58) .....268.95                                     | 67E Circular Polarizer (LECP67Q) .....283.50                            |
| E39 UVa Glass Filter (LEUV39) .....59.95   | E77 UVa (LEUV77) .....119.95  |
| Silver E39 UVa (LEUV39S) .....59.95  | 77E Circular Polarizer (LECP77) .....285.95                             |
| E46 UVa (LEUV46) .....79.95  | Universal Polarizer for M Lenses (requires adapter) (LEUPM) .....367.50 |

# LEICA

## R9

### 35mm Manual Focusing SLR Camera

*A unique technological masterpiece, the R9 is the outstanding result of years of development work. Embodying all of Leica's optical and mechanical know how, the R9 meets the highest demands down to the smallest detail in order to deliver the very best—brilliant photographs, even under extremely difficult light conditions. The R9 gives you the confidence of being able to rely fully on precise automatic procedures – as long as you so desire. But you can also exercise your creative latitude as much as you wish with all camera functions. With its many manual setting possibilities, the R9 always leaves it up to you to what extent you wish to control the exposure yourself.*

*Photography thrives on the creative freedom of photographers, and that freedom doesn't like to be encumbered by*

*complicated technology. Leica recognized this a long time ago. Guided by this policy, the R9 isn't crammed with every possible feature into the camera – only those features that make good sense – and at Leica's level of excellence. Special attention was paid, for instance, to the photographer's freedom to exercise complete control. Furthermore, the uniquely brilliant viewfinder enables him or her to evaluate the depth of field and the cropping.*

*With mechanical precision down to the finest details, innovative optics and intelligently thought-out electronics, the R9 is designed to implement your ideas with the highest possible quality. This opens all the possibilities for spontaneous, individualized creativity. And with it, flexibility, freedom, and not least the great pleasure of working with a superb camera.*



#### FEATURES

- ◆ All operating elements of the R9 are positioned very conveniently and can be operated intuitively, without moving the eye away from the viewfinder. The rugged metal body fits very nicely in your hands and it weighs an ideal 27 oz.
- ◆ Thanks to its R bayonet, the R9 is compatible with virtually all R lenses made since 1965. Nearly all current Leica R lenses are equipped with ROM contacts, which establish specific communication between camera and lens, leading to perfect exposures.
- ◆ Judiciously balanced in every detail, the design of the R9 will quickly excite you. Its compact external appearance is attractive because of the clarity of its contours and the harmony of all its proportions. The prism housing that usually clearly protrudes on other SLR cameras is integrated into the shape of the R9 camera body with elegant restraint, so that it is but a graceful contour. The main operating elements also don't protrude, and are recessed into the housing instead.
- ◆ The R9's distinctive styling stands out for its unique clarity and timeless elegance. Its sturdy metal construction makes it robust and durable. With outstanding ergonomic design, the R9 fits very well in the hands, even with long focal length lenses.
- ◆ Flexibility and comfort are also emphasized in conjunction with the film advance. Easy film advance starts with the insertion of the film cartridge, because you are spared the usually cumbersome threading.
- ◆ When the optional winder or motor drive is being used, you can also decide whether the film tongue is to be rewound completely into the cartridge or not.
- ◆ With double exposures too, you have every option: avoid double exposures altogether – or implement them deliberately, because the R9 has an extra lever that uncouples the film advance mechanism and accurately locks the film in its position.

A skilled photographer can use any camera to take good pictures. However, for outstanding photographs that fully satisfy their own standards of quality, a tool that functions at least as accurately as he or she does is needed. Leica SLR cameras enable the execution of creative ideas confidently in all situations, because every Leica is a precision instrument, manufactured by with great dedication and scrupulous accuracy. The Leica R system embodies over a hundred years of optical and mechanical experience, combined with the most modern manufacturing technology and special craftsmanship that make Leica cameras and lenses legendary.



For Any Inquiries Regarding Your Order, Call Our Customer Service:  
(800) 221-5743 • (212) 239-7765 • FAX: (800) 947-2215 • (212) 239-7549



### The Viewfinder

The bright and contrasty viewfinder image showcases the imaging quality of Leica R lenses with full brilliance, while it provides all the relevant information at a glance:

- ◆ A single LCD line below the viewfinder image provides a clear, unobtrusive overview of, among other things and depending on the operating mode: exposure number, operating mode, metering method, light balance with manual exposure setting, flash readiness as well as the aperture-and-shutter-speed combination, etc. With zoom lenses that have a focal-length-dependent aperture range, the actual aperture is shown in the viewfinder display in steps within the respective aperture range.
- ◆ The high-eyepoint viewfinder itself offers an absolutely brilliant and contrasty image. Even under unfavorable light conditions, it provides a bright, dimensional image of every subject and all its nuances, exactly as you see it. And it does so all the way into the corners of the focusing screen – without your having to press your eye to the eyecup. For convenience, the eyecup can be locked in place, so it doesn't get lost.



- ◆ For time exposures an integrated shutter prevents light from reaching the film through the eyepiece.
- ◆ Diopter compensation range from  $\pm 2$  in half steps, enables photographers to focus and expose with or without their glasses.
- ◆ The R9 is equipped with an interchangeable universal focusing screen (ground glass screen with microprism ring and wedge). Four additional focusing screens are optionally available: uniform ground glass screen, microprism focusing screen, uniform ground glass screen with grid divisions, clear glass screen with cross lines.

### LCD Back Display—Welcome to the Information Center

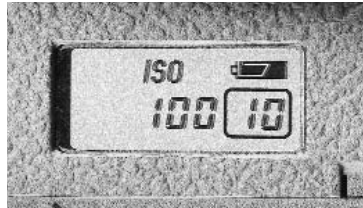

Even when your eye is not at the viewfinder, you can easily survey all the parameters. The R9 features an illuminated LCD display on the back cover of the camera for added convenience. In addition to certain parameters that are also shown in the viewfinder, it provides information about film speed, self-timer operation and battery condition. When the camera is switched on, the LCD shows, among other parameters, the exposure counter, including multiple exposures, battery condition (in two steps), exposure corrections, flash readiness and the exposure deviation in the F mode. Beyond that, the display shows the elapsed seconds during time exposures.

- ◆ Exposures in the multi-pattern metering mode can not only be controlled by means of the exposure compensation switch and the ISO keys via the back cover display, they can also be adjusted individually. If you wish, the exposure level can be modified to suit your preference and programmed permanently in steps of one tenth of an f-stop (max.  $\pm 0.7$  stop) in the multi-pattern metering mode and in accordance with the type of film being used.
- ◆ Film speed can be read on the back cover LCD display. Thanks to DX coding, you can begin to take pictures immediately after loading the film without risking exposure errors. Manual changes of the ISO setting can be done to satisfy individual preferences: for more intense color saturation in the case of slide films for instance, or for push-processing. The film speed read from the DX coding is shown permanently in the display.
- ◆ The self-timer can be set for two shutter release delays : 2-sec. and 12-sec. The time remaining before the shutter is released is shown on the back cover display in the form of a countdown. A red LED on the front of the camera blinks while the self-timer is activated.

### Exposure Control—Designed to Master any Situation

Equipped with an extremely sensitive metering system with three specific exposure metering modes, the R9 makes it easy for you to react to the most diverse lighting situations. Whether you opt for an intelligent, fully automatic determination of a balanced exposure or whether you wish to control this process yourself – the R9 provides you with a free choice.

- ◆ Multiple-pattern metering automatically analyzes the prevailing light and derives an optimal exposure from the results. The brightness values of six different sections are measured and stored separately. The values are then assigned to preprogrammed subject types that are coupled with prescribed control instructions. The individual sections are then weighted and coordinated with the full subject area. The result: exposures that are always well balanced, even in extreme contrast situations, above- and below average brightness conditions or unusually positioned main subjects. And since different films require tailored exposure settings (short exposures for transparencies, long exposures for negatives), the exposure level of the multiple pattern exposure metering mode can be adjusted in 1/10s of a step to suit individual wishes.
- ◆ Selective metering with the R9 is the first choice for all those photographs that pose a genuine challenge: back-lit situations or subjects with extreme contrasts. Selective metering covers a narrowly limited subject area. The exposure value determined by this precise metering method can be stored by gently pressing the shutter release button to the first pressure point and holding it there until you have found your optimal composition. Shutter speed or aperture settings can still be changed, because the camera will automatically compensate the second setting to maintain the metered exposure value.
- ◆ Integral metering is suitable primarily for balanced light situations. In this mode, the entire subject is center-weighted and metered – an optimal solution for subjects that are centered anyway. Integral metering is of practically universal application, you retain control of the exposure. That is why it is particularly appropriate for specific overrides : over- or underexposures by means of  $\pm$  corrections. The override switch can be activated safely even while the eye is at the viewfinder.

# LEICA

## R9

### **Program Modes**

The R9 offers four different operating modes, all of which can readily be combined with the three metering methods. (Shutter speed is stepless in automatic program and aperture priority modes from 32 to 1/8000 sec., and in half-steps from 16 to 1/8000 sec., in shutter speed priority and manual exposure modes.) For added convenience the operating mode selector dial can be locked, ensuring that your setting will be retained, so that you can start making exposures in the selected mode at any time.

#### **P – Variable Automatic Program Mode:**

Interesting subjects require a quick reaction. Those are perfect situations for the variable automatic program mode, because it spontaneously and instantly sets the appropriate combination of shutter speed and aperture. In addition, by turning the shutter speed dial, you can change the shutter speed and aperture combination established by the camera at any time to suit the desired pictorial effect. Thus the variable automatic program mode very conveniently takes care of freezing a fast-moving subject or deliberately reducing the depth of field.

#### **A – Aperture Priority:**

While you concentrate on the choice of just the right aperture for your photograph the camera sets the proper shutter speed. On the R9, you can use the preview lever to evaluate the depth of field directly through the viewfinder. And thanks to HSS (High Speed Synchronization) you can now use flash with all shutter speeds.

#### **T – Shutter Speed Priority:**

You set the shutter while the camera automatically sets the correct aperture. By pre-setting the shutter speed, for instance, you can opt for a sharp, frozen image of the subject, or use it to create a dynamic blur.

#### **M – Manual Operation:**

Ideal when you are working under unusual light conditions and you wish to capture a very special mood. In this mode, you set both the shutter speed as well as the aperture, and you can change them in half steps. By using the selective metering mode, you can control the exposure very precisely.

### **USING FLASH—LIGHT DOESN'T EQUAL LIGHT**

*The flash exposure control of the R9 enables you to achieve any desired lighting mood. It determines the particular individual flash intensity and automatically and precisely balances the flash with the surrounding ambient illumination. If you prefer, you can also make these settings.*

#### **Metering During the Exposure:**

Flash illumination – like daylight illumination – is metered through the lens. With dedicated flash units, this takes place in the center-weighted integral mode. You can, however, choose one of several modes in order to take advantage of different creative possibilities: The variable automatic program mode measures the ambient light and tailors the flash intensity to it in a pleasing manner. In shutter speed and aperture priority modes or in manual, you can preset the shutter speed or the aperture, respectively, and enter the corrections of the amount of flash for the desired pictorial effect.

#### **Metering Before the Exposure:**

With the R9, flash exposure can also be metered before making the actual exposure. The metering in this case is limited to the part of the subject outlined by the circle in the center of the viewfinder image. This makes it possible to tailor the flash illumination specifically to a particular detail of your subject. Flash brightness is metered by means of a pre-flash directed at the subject. The result is shown in the over- and under-exposure reading in the back cover display and it can be corrected quickly by manually selecting the appropriate aperture. Brightness of the entire subject is subsequently measured in one of the three metering modes, and then the actual exposure is made. The selective flash mode F thus leads to perfectly balanced pictures in conjunction with an external flash unit.



#### **High-Speed Flashes:**

With High Speed Synchronization (HSS), the R9 permits super-fast flash exposures with shutter speeds up to 1/8000 (in conjunction with an HSS flash like the Metz 54MZ-3). By triggering numerous flashes in very fast succession, the effect comes very close to that of a constant light source that uniformly illuminates the entire image area. This makes it possible, for instance, to achieve a fill-flash effect in portraits being taken in sunshine with a wide-open aperture. The flash exposure is determined by means of a pre-flash with selective metering of the main subject. As long as the camera's electronics are activated, the result of the pre-exposure metering remains stored independently of the result of the ambient light metering, so that the desired cropping can be chosen freely after that measurement has been stored.

#### **First or Second Shutter Curtain:**

You can set the timing of flash synchronization yourself by using the respective lever position. This determines whether the flash is triggered at the beginning of the exposure as usual, or whether it is fired at the end of the exposure. These two modes can often render the very same subject quite differently. When the flash is triggered at the end of the exposure (i. e. synchronized with the second shutter curtain), moving subjects are depicted more realistically. This effect becomes much more dramatic with long exposure times.



### R9 SPECIFICATIONS

|                                |   |
|--------------------------------|---|
| <b>Type:</b>                   | 35mm SLR  |
| <b>Lens Mount:</b>             | Leica R (NOTE: Older model R lenses fit, but with limited camera functions)   |
| <b>Focus Modes:</b>            | Manual  |
| <b>Focus Type:</b>             | Manual  |
| <b>Focusing Range:</b>         | Not applicable  |
| <b>Exposure Modes:</b>         | Variable Program, Aperture Priority, Shutter Priority, Manual, TTL Flash and "F" Mode (for non-dedicated flash & studio lighting)             |
| <b>Exposure Metering:</b>      | - 6-Zone evaluative<br>- Centerweighted - Spot<br>- Built-in flash metering mode for non-dedicated or studio lighting                         |
| <b>Metering Range:</b>         | EV -2 to 20 (with f/1.4 lens @ ISO 100)   |
| <b>Shutter Speed:</b>          | 1/8000 to 32 seconds + Bulb, with flash sync up to 1/250 second, 1/350-1/8000 with Metz module  |
| <b>Exposure Compensation:</b>  | ±0.7EV in 1/10 EV increments  |
| <b>Exposure Bracketing:</b>    | 3 Frames in 1/2 or whole steps with optional motor drive  |
| <b>ISO Range:</b>              | • 25-500 (DX) • 6-12800 (manual setting)  |
| <b>Film Wind:</b>              | Manual (optional winder or motor drive available)   |
| <b>Focusing Screen:</b>        | Interchangeable (standard screen is matte with microprism & split image rangefinder)  |
| <b>Diopter Correction:</b>     | Yes (-2 to +2)  |
| <b>Self Timer:</b>             | 12 or 2-Second delay  |
| <b>Remote Control:</b>         | Standard mechanical cable release   |
| <b>PC Terminal:</b>            | Yes   |
| <b>Depth-of-Field Preview:</b> | Yes   |
| <b>Mirror Lock-Up:</b>         | Yes   |
| <b>Multiple Exposure:</b>      | Yes   |
| <b>Viewfinder Information:</b> | Metering type, Metering memory activation, Flash readiness, Aperture, Shutter speed, Test flash result and Frame counter, Low light indicator |
| <b>Power Source:</b>           | Two CR2 3-volt lithium batteries  |
| <b>Dimensions:</b>             | 6.2 x 4.0 x 2.4" WxHxD  |
| <b>Weight:</b>                 | 1.74 lb.  |

### Digital Modul-R (LDMR)

*The Digital Modul-R is a digital camera back designed for the Leica R8 and R9 cameras. With the back they become the world's first hybrid 35mm cameras that can be used optionally for digital or analog photography.*



- ◆ The image sensor consists of a 10-megapixel CCD sensor specially produced by Kodak. The integration of the sensor into an existing camera concept requires that the sensor and its housing be positioned at the film gate of the R8 or R9. That is why the active surface of the sensor is smaller than the area of the film gate, limiting the resulting focal length extension factor to a modest 1.37x. The effective imaging area of the sensors measures 26.4 x 17.6mm. Sensitivity ranges from ISO 100 to at ISO 800.
- ◆ In addition to the high quality picture, the Digital Modul-R provides a solution that is as compact as possible, with a logical operating procedure. This means that the settings that are relevant for the exposure are easy to control by means of a clearly legible display and a setting dial, without having to use the menu guide on the color monitor.
- ◆ Functions that can be controlled directly are: sensitivity setting, resolution, compression, white balance, self-timer, and exposure corrections. Menu functions on the color monitor are for configuring the back—setting the user profile, color management, or brightness and contrast of the color monitor. Because functions can be controlled directly while shooting by means of the setting dial, the content of the menu is minimal and it provides a clear overview.
- ◆ The color monitor on the digital back is used for evaluating the images stored after the exposures:
  - A histogram furnishes detailed information about the dynamics of the photograph, thus providing the possibility of a differentiated analysis of the pictorial result.
  - An audio histogram signals over- and under-exposures acoustically: The photographer is assured of correct exposures while working continuously, without having to move the camera away from the eye.
- Data-formats include RAW, TIFF, 2 JPEG-compression rates; uses SD-cards for storage; offers an IEEE1394 (Firewire) interface
- BW display shows frame counter, ISO, exposure compensation, battery status, flash ready signal, self timer, compression rate, resolution, moiré on/off, white balance.
- Menu includes: sharpness, color saturation, contrast, frame number, color display brightness and contrast, duration of auto review, histogram on/off, power save options, card formatting, warning signals, audio histogram on/off, date, time, user-profiles, firmware update, reset.

**CALL**

# LEICA

## R LENSES

The fascination of the name Leica is rooted as much in the superb mechanisms of the camera as it is in the proverbial precision and quality of its legendary lenses. And with the R9 too, the entire spectrum of R lenses developed since 1965 is applicable, supplemented by their latest designs in the fields of wide-angle and zoom lenses. R lenses and the R9 body form a system that is ready for use immediately and that functions dependably. Making it easy for you to create perfect pictures.

Leica lenses are masterpieces, many of them of legendary fame. The quality of the optical glasses is the basis of this extraordinary reputation. Produced in accordance with special recipes, ground to clear perfection, meticulously polished, coated with extremely precise layers and repeatedly centered. In a synthesis of continually refined software and the long-time experience of highly specialized designers, Leica optics have been computed with the aid of electronic data processing systems since the fifties. The lenses stand out because of their imaging quality, which always receives top ratings in specialized photographic magazine tests and which are unequalled internationally.

You'll benefit from yet another exclusive advantage, a special feature that only Leica offers: The specific parameters of every current R lens (not just the general parameters of a given lens type) are measured individually and programmed into the ROM module of each lens, so they can communicate to the camera by means of appropriate contacts. This enables the R9 to conform precisely to true focal lengths and apertures in order, for instance, to control flash exposures accurately.

### SUPER WIDE-ANGLE LENSES

Super wide-angle lenses are fascinating because of their enormous angle of view, which covers a much greater field of view than standard focal lengths do, for instance. They characteristically produce intensified perspectives with monumental foregrounds and rapidly receding backgrounds.



15mm f/2.8 Elmarit-R



19mm f/2.8 Elmarit-R

#### 15mm f/2.8 Super-Elmarit-R ASPH (LE1528R)

This ultra-wide-angle lens has the shortest focal length in the L-series. Aspherical lens element corrects distortion and other aberrations such as astigmatism, resulting in ideal image quality. Floating rear focusing system makes autofocus faster, and the lens more compact. Full-time manual focusing lets you switch to manual focus even in AF mode. The lens also has a fixed petal-type hood and a gelatin filter holder at the rear .....6195.00

#### 19mm f/2.8 Elmarit-R (LE1928RQ)

The 19mm f/2.8 is a compact, super-wide-angle lens with an angle of view of 96°. Its relatively high speed considerably expands its range of applications, especially in landscape, architectural and fashion photography. It is also an ideal lens for snapshots and for photojournalism, even wide open. Very high contrast, perfect reproduction of the finest details and ample imperviousness to stray light even at full aperture emphasize the versatility of this wide-angle lens. A built-in filter revolver comes with four different filters .....3395.00

#### 24mm f/2.8 Elmarit-R (LE2428R)

A large angle of view, relatively high speed and excellent imaging performance, even at full aperture are a perfect combination to give this lens a special place in dynamic photojournalism in very confined spaces. It creates impressive images with extraordinary perspectives, but without the impression that a super wide-angle lens was used. Particularly suitable for spontaneous close-ups with a dynamic relationship between the main subject and its surroundings that results from the combination of a large angle of view, large aperture, and very good imaging performance, even at full aperture. Equipped with a lens hood and filter holder .....2495.00

# LEICA

## R LENSES

### STANDARD WIDE-ANGLE LENSES

Standard wide-angle lenses are very versatile for everyday photography. Compared to normal lenses, they provide a distinctly larger coverage of the subject while still reproducing all size relationships with a relatively natural appearance.

#### 28mm f/2.8 Elmarit-R (LE2828R)

Remarkably light and compact, the 28mm f/2.8 Elmarit-R's relatively high speed and harmonious wide-angle characteristics make it a very pleasant and universally applicable companion. Its outstanding rendition of fine structures and the rich contrast in the reproduction of contours, already at large apertures are the strengths of this popular wide-angle lens. The angle of view is 76° and the focusing range is from infinity to 11". It comes with a built-in sliding lens hood.....2195.00

#### 28mm f/2.8

#### PC Super-Angulon-R (LE2828PCR)

The "PC" in this lens stands for perspective correction. It is designed for architectural photography, because it can straighten out those annoying converging lines. The large usable image circle diameter of 62mm makes it possible to shift the complete optical system by 11mm away from the optical axis. This makes it possible to eliminate converging lines, especially in interior- and in architectural photographs.....2695.00



28mm f/2.8 Elmarit-R

28mm f/2.8 PC Super-Angulon-R

#### 35mm f/1.4 Summilux-R (LE3514R)

An ultra-fast wide-angle lens designed for shooting in low light. It is impressive for its outstanding imaging performance with subjects that include strong contrasts. It yields a very good sharpness impression and it is also hardly affected by stray light. "Floating elements" produce an outstanding image reproduction, even in the near-focusing range. Has an integrated lens hood .....3295.00

#### 35mm f/2 Summicron-R (LE352R)

The 35mm Summicron-R is deal for candid photography, even in low light. It features low vignetting, minimal distortion and very good stray light prevention. Ideally suited for vivacious snapshots and a dimensional, natural rendition of ample subjects – in other words, whenever the use of a normal focal length would result in perspectives that are too tight. Integrated lens hood.....2095.00

### STANDARD LENSES

Leica's standard lenses are small and lightweight with high performance. They combine high speed with outstanding imaging capabilities, and they are especially versatile, because their angle of view of 45° comes closest to the visual coverage of the human eye.



50mm f/2 Summicron-R

50mm f/1.4 Summilux-R

#### 50mm f/2 Summicron-R (LE502R)

This versatile lens is considered the standard for image quality in 35mm format. Its 50mm focal length makes creative compositions possible in the classical format, especially in near- and medium distance ranges. Ideally suited for travel photography, because its length (1 1/2") and weight (10 1/2 oz.) make it compact and handy. Shortest focusing distance is 20". In spite of its high speed, it distinguishes itself by its outstanding sharpness, high contrast and excellent detail resolution, even at full aperture. Integrated lens hood .....1045.00

#### 50mm f/1.4 Summilux-R (LE5014R)

This handy universal lens produces outstanding results with uniform performance across the entire image area, even under difficult light conditions and at large apertures. Thanks to its high speed, it renders fine details very clearly and with rich contrast at all apertures and distances. Handy and extremely fast lens for on-site reporting. Maximum f/1.4 aperture with the correspondingly very shallow depth of field, provides exceptional opportunities for very creative compositions. Integrated lens hood .....2395.00

# LEICA

## R LENSES

CAMERAS & LENSES

70

### MACRO LENSES

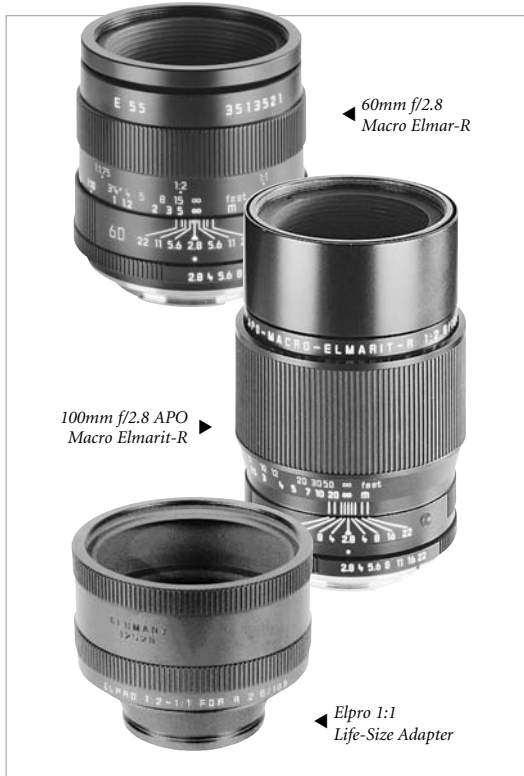

#### **60mm f/2.8 Macro Elmarit-R (LE6028R)**

Very good image quality in the close-up range, great sharpness and excellent detail fidelity, the 60mm f/2.8 Macro-Elmarit is impressive, not only in macro photography, but also in all applications that require these strengths. Offers a focusing range from infinity all the way down to a mere 10% (a maximum reproduction ratio of 1:2). With the optional Macro-Adapter R, a reproduction ratio of 1:1 can be achieved .....**2195.00**

#### **100mm f/2.8 APO Macro Elmarit-R (LE10028AR)**

A fast macro lens with apochromatic correction, the 100mm f/2.8 is as good for format-filling pictures from somewhat greater distances as it is for portraits from medium range. Delivers outstanding imaging performance over its entire focusing range, from infinity to 17%. With its high speed and high contrast and practically non-existent vignetting and distortion, details are clearly differentiated in all images and at all distances. Use the optional Elpro 1:1 Life-Size Adapter to extend its reproduction ratio down to 1:1. Has an integrated lens hood.....**2995.00**

#### **Life-Size Adapters**

Designed exclusively for the 60mm f/2.8 Macro and 100mm f/2.8 APO-Macro, these close-up attachments allows the lenses to achieve a reproduction ratio of 1:1.

#### **Macro Adapter R (LEMARRC)**

For the 60mm f/2.8 Macro Elmarit-R lens.....**459.95**

#### **Elpro 1:1 Life-Size Adapter (LEE100)**

For the 100mm f/2.8 Macro APO Macro Elmarit-R lens.....**467.50**

### PORTRAIT LENSES

#### **80mm f/1.4 Summilux-R (LE8014R)**

This lens is predestined for lively portraits, personality studies and hand-held photography. It works with minimal vignetting, renders tonal values clearly and in fine nuances and it renders a uniform imaging performance across the full format – with very good reproduction of fine subject details. The exquisite advantages of this high-speed, high-performance lens is clearly evident, especially in available light photography. Even at full aperture, it stands out because of its freedom from reflections and the fine nuances of its tone reproduction. Integrated lens hood.....**3295.00**

#### **90mm f/2 APO Summicron-R ASPH (LE902AAR)**

Reportage photography and portraiture are the principal applications of this very compact telephoto lens. An aspherical lens surface and optical glasses with anomalous partial dispersion lead to outstanding imaging performance, great sharpness and brilliant contrasts. That also makes it very easy to focus. It has an integrated lens hood that can be locked in place.....**2695.00**



For Any Inquiries Regarding Your Order, Call Our Customer Service:  
(800) 221-5743 • (212) 239-7765 • FAX: (800) 947-2215 • (212) 239-7549

# LEICA

## R LENSES

CAMERAS & LENSES

71

### TELEPHOTO LENSES



180mm  
f/2 APO  
Summicron-R

180mm  
f/2.8 APO  
Elmarit-R

280mm f/4  
APO Telyt-R

#### 180mm f/2 APO Summicron-R (LE1802AR)

Super fast telephoto lens with apochromatic correction produces flawless image quality all the way to the edges of the picture. From infinity to 5'. Even at full aperture, you'll get shots with maximum contrast highest resolution and delicately differentiated color rendition. Practically diffraction-limited imaging performance and outstanding color differentiation already at full aperture, plus perfect contrasts and flare-free rendition of the finest details – this lens, with its shallow depth of field and outstanding image quality, opens many creative possibilities. Internal focusing makes the overall length of the lens remain constant during focusing, and it always feels well balanced in your hand. The optical system includes a protective filter for the front element and a Series 6 filter for the filter drawer, a rotating and lockable tripod mount, integrated lens hood, and eyelets for a carrying strap.....**6395.00**

#### 180mm f/2.8 APO Elmarit-R (LE18028AR)

Perfect hand-held exposures require a lens like this one: peak performance at full aperture, extremely high contrast, and clear rendition of the finest nuances. The overall optical performance of this apochromatically corrected 180mm lens make even the most critical photographers enthusiastic. At full aperture it has outstanding image quality that can hardly be improved by stopping the lens down. Coma, vignetting, astigmatism and curvature of field are practically nonexistent. It is remarkably compact and elegant for a lens with this focal length. It is excellent choice for portraiture, fashion, sports and landscape photography – even when you are working without a tripod. All in all, it is a fast high-performance telephoto lens that satisfies the highest expectations, even under difficult conditions. It has an integrated lens hood.....**3695.00**

#### 280mm f/4 APO Telyt-R (LE2804R)

The 280mm is an apochromatically corrected lens with internal focusing. Distortion-free, it performs extremely well across its entire focusing range with highest resolving power, precise color rendition and optimal contrast reproduction – even at full aperture. Closed down by one stop, using a tripod and mirror pre-release, even the finest details are reproduced clearly. Focuses down to 67", and in combination with the optional Macro Adapter-R it gets you as close as 51". Barely 8 1/4" long, you can still use it for hand-held photography. Includes tripod mount, integrated lens hood, filter drawer and eyelets for a carrying strap .....**5195.00**

### TELECONVERTERS

#### APO-Extender-R 1.4x (LE1.4XAR)

This handy lens attachment lets you increase the focal length of a lens by a factor of 1.4 x. The respective closest focusing distance remains unchanged and the aperture is reduced by only one f-stop. Fully automatic iris diaphragm coupling .....**1495.00**

#### APO-Extender-R 2x (LE2XAR)

Suitable for Leica R lenses with focal lengths of 50mm and higher and maximum apertures of f/2 or smaller. When used in conjunction with Leica APO lenses, the high imaging performance of the latter remains fully preserved. The APO-Extender-R 2x has a fully automatic diaphragm coupling so that it can be used without restrictions in the aperture priority automatic exposure control mode as well as the manual control mode .....**1795.00**



APO Extender  
R 1.4x

APO Extender  
R 2x

ORDER & INFO. (212) 502-6340 • FAX: (212) 239-7770 (800) 947-7008  
**1-800-290-6750 • www.bhphotovideo.com**



# LEICA

## R LENSES

### The APO-TELYT-R Module System

The APO-TELYT-R Module System covers the range of focal lengths from 280 to 800 mm, replacing heavy individual lenses with fixed focal lengths, making it particularly attractive for nature- and sports photographers. With a twist of the wrist, six different APO lenses of the very highest optical quality can be created from two lens heads and three extremely compact focusing modules. The result, uncommonly clear pictures with very high contrast and absolute detail- and color fidelity can be achieved where atmospheric disturbances and light haze or fog would otherwise reduce the image quality considerably. Because the smallest mechanical errors and weaknesses in this range can clearly diminish the performance, the Leica Module System is very sturdy and assembled with extremely tight tolerances.

All you need to do, is to join an APO-TELYT-R lens head and an appropriate focusing module to obtain the desired focal length to suit a particular photographic task. Thanks to a special bayonet and the large locking ring, this can be done quickly and easily. The advantage of this intelligent system: you don't have to carry along many large and heavy individual telephoto lenses.

Instead, you simply combine modules as you need them. And you always have telephoto lenses with focal lengths from 280 to 800mm at your disposal. With a twist of the wrist, six different APO-lenses are created from two lens heads and three focus modules – each one with unexcelled optical quality. Last, they feature remarkably short near-focusing distances of 6.6' to 12'4", expanding their creative possibilities significantly.



### APO-TELYT-R FOCUS MODULES

With this single focusing mount, the two lens heads can be converted into a: 280mm f/2.8 or a 400mm f/2.8 APO-TELYT-R



Focus Module 1X (LEFM1X)

With this single focusing mount, the two lens heads can be converted into a 400mm f/4 or a 560mm f/4 APO-TELYT-R



Focus Module 1.4X (LEFM1.4X)

With this single focusing mount, the two lens head can be converted into a 560mm f/5.6 or an 800mm f/5.6 APO-TELYT-R



Focus Module 2X (LEFM2X)



LE280HR  
280/400/560mm APO-TELYT-R



280mm f/2.8 APO-Telyt-R



400mm f/4 APO-Telyt-R



560mm f/5.6 APO-Telyt-R



LE800HR  
400/560/800mm APO-TELYT-R



400mm f/2.8 APO-Telyt-R



560mm f/4 APO-Telyt-R



800mm f/5.6 APO-Telyt-R

Depending on which focus module is attached, the APO-TELYT-R 280/400/560mm lens head becomes a: 280 mm f/2.8 APO-TELYT-R, 400 mm f/4 APO-TELYT-R, or 560mm f/5.6 APO-TELYT-R.

Depending on which focus module is attached, the 400/560/800mm APO-TELYT-R lens head becomes a: 400 mm f/2.8 APO-TELYT-R, 560mm f/4 APO-TELYT-R, or an 800mm f/5.6 APO-TELYT-R.



# LEICA

## R LENSES

### WIDE ANGLE and STANDARD ZOOM LENSES

Leica zoom lenses are a perfect combination of versatility and high optical performance. This makes them ideal travel companions for demanding photographers. And a zoom lens is simply indispensable in those fleeting moments when there is no time to change lenses. With a telephoto zoom lens, you are able to select an optimal cropping of your subject from a distance, without having to change your camera position.

#### 21-35mm f/3.5-4

##### Vario Elmar-R ASPH (LE213535AR)

Compact wide-angle zoom lens employs two aspherical surfaces, one of which is produced by grinding and polishing a concave surface. The image quality corresponds to that of lenses with equivalent fixed focal lengths: very high contrast, the finest details, neutral and saturated colors, very low sensitivity to stray light and uniform performance across nearly the entire image area at all distances. Petal-shaped lens hood can be stored on the lens in reverse position .....2295.00

#### 28-70mm f/3.5-4.5

##### Vario Elmar-R (LE287035R)

The strength of this versatile lens is its uniform imaging performance across its entire focusing range. Those who like to take pictures in an unencumbered manner will find this compact and handy lens the ideal travel companion. Thanks to the extended focal length range, you can master everything with flying colors – from landscape and group photographs all the way to staged single portraits. Most photographers will also appreciate the separate control rings for focus and aperture.....Call

#### 28-90mm f/2.8-4.5

##### ASPH Vario Elmar-R (LE289028R)

Covering the four most common fixed focal lengths with no loss of quality, the 28-90mm f/2.8-4.5 can be used in a variety of situations, from landscape photography, to group photographs to individual portraits. Distortion or vignetting is negligible. Focus, contrast and resolution are excellent, even with the aperture fully open. The use of two aspherical lens surfaces and two lens elements each of highly refractive glass and anomalous partial dispersion results in extraordinary lens performance with a comparatively compact design and low weight. For added convenience, the lens is equipped with a built-in lens hood with petal shaped sections, optimally co-ordinated to the path of the rays. A slip on cover is also included and can be fitted to the lens to prevent dust and sand from getting in. The lens comes in a soft leather case.....3395.00



21-35mm f/3.5-4  
Vario Elmar-R ASPH



28-90mm f/2.8-4.5  
ASPH Vario Elmar-R



28-70mm f/3.5-4.5  
Vario Elmar-R



70-180mm f/2.8  
Vario APO Elmarit-R



35-70mm f/4  
Vario Elmar-R

#### 35-70mm f/4 Vario Elmar-R (LE35704R)

This lens covers all the classical focal lengths. A handy two-ring zoom lens with normal speed, it offers very good imaging qualities as well as ease of operation. High optical performance is achieved via aspherical lens element and other refinements. Contrast and image reproduction quality are comparable to those of lenses with equivalent fixed focal lengths. Because of its very good gradation of shadow areas and of highlights, it is ideal for subjects with great lighting contrasts. In the macro range you can shoot as close as 10". That corresponds to a reproduction ratio of 1:2.8, permitting format-filling photographs of very small subjects.....1395.00

#### 70-180mm f/2.8

##### Vario APO Elmarit-R (LE7018028R)

An apochromatically corrected zoom lens with an optical performance that compares with fixed focal length lenses. Even at full aperture, it delivers outstanding definition across its entire focal length range. Coma and astigmatism are practically non-existent. Two separate setting rings for focus and focal length make it especially easy to select the right cropping of your subject. Its application possibilities are virtually unlimited: stationary as well as moving subjects that require quick or careful changes of cropping. This lens has an integrated lens hood, eyelets for a carrying strap, and is equipped with a rotating and locking tripod mount .....5695.00

CAMERAS & LENSES

7/3

ORDER & INFO. (212) 502-6340 • FAX: (212) 239-7770 (800) 947-7008  
1-800-290-6750 • www.bhphotovideo.com



# LEICA

## R LENSES

CAMERAS & LENSES

74



150-280mm f/4.2  
Vario Elmar-R

80-200mm f/4  
Vario Elmar-R

### 80-200mm f/4 Vario Elmar-R (LE802004R)

The performance of this rotating zoom lens is quite comparable to that of first-class lenses with fixed focal lengths. It offers very good imaging quality with high resolving power and outstanding contrast rendition over the full image area for the entire focal length range. And it is quite compact and rests comfortably in the palm of one's hand. Its extraordinary near-focusing distance of only 3.7" makes a smallest object field of 3 1/16" x 5 1/2" possible. Its compact dimensions, its light weight and its smooth focusing make this zoom lens an ideal travel companion. In combination with the 21-35mm and the 35-70mm Leica zoom lenses, both of which render nearly identical, uniform image quality, a practically continuous 10:1 focal length is achieved.....**2095.00**

### 105-280mm f/4.2 Vario Elmar-R (LE10528042R)

A telephoto zoom lens with an especially large range of focal lengths that enables you to make large images of far away details. Its range of focal lengths and its short focusing distance of 67" provide flexibility in the choice of subjects and in the range of applications for medium- and long telephoto distances. Because it can also be used in combination with Leica Extenders, this zoom lens is more than just a single lens, it is an optical system with outstanding imaging quality that has universal applications.

The lens is absolutely comparable to fixed focal length lenses of the highest quality. At every setting, its high-speed optical system delivers high contrast rendition and outstanding resolving power. Like the 70-180mm f/2.8 Vario APO Elmarit-R, it has two separate setting rings for focal length and focus, as well as a rotating an locking tripod mount that is especially useful with the longer focal lengths.....**5695.00**

| Lens Designation          | Focal Length/Speed in mm | Angle of View | Lens Elements/Groups | Smallest Aperture | Filter Size          | Length in mm | Weight in grams |
|---------------------------|--------------------------|---------------|----------------------|-------------------|----------------------|--------------|-----------------|
| FISHEYE-ELMARIT-R         | 16 f/2.8                 | 180°          | 11/8                 | 16                | built-in             | 60           | 460             |
| ELMARIT-R                 | 19 f/2.8                 | 96°           | 12/10                | 22                | built-in             | 60           | 560             |
| ELMARIT-R                 | 24 f/2.8                 | 84°           | 9/7                  | 22                | Series 8             | 48.5         | 400             |
| PC-SUPER-ANGULON-R        | 28 f/2.8                 | 73/93°        | 12/10                | 22                | Special filter 67 EW | 84           | 600             |
| ELMARIT-R                 | 28 f/2.8                 | 76°           | 8/7                  | 22                | E55                  | 48           | 435             |
| SUMMILUX-R                | 35 f/1.4                 | 64°           | 10/9                 | 16                | E67                  | 76           | 690             |
| SUMMICRON-R               | 35 f/2                   | 64°           | 6/6                  | 16                | E55                  | 54           | 430             |
| SUMMILUX-R                | 50 f/1.4                 | 45°           | 8/7                  | 16                | E60                  | 51           | 490             |
| SUMMICRON-R               | 50 f/2                   | 45°           | 6/4                  | 16                | E55                  | 41           | 290             |
| MACRO ELMARIT-R           | 60 f/2.8                 | 39°           | 6/5                  | 22                | E55                  | 62.3 (92.3)  | 400 (530)       |
| SUMMILUX-R                | 80 f/1.4                 | 30°           | 7/5                  | 16                | E67                  | 69           | 700             |
| APO-MACRO ELMARIT-R       | 100 f/2.8                | 25°           | 8/6                  | 22                | E60                  | 104.5 (140)  | 760 (950)       |
| APO-SUMMICRON-R           | 180 f/2                  | 14°           | 9/6                  | 16                | Series 6             | 176          | 2500            |
| APO-ELMARIT-R             | 180 f/2.8                | 14°           | 7/5                  | 22                | E67                  | 132          | 970             |
| APO-TELYT-R               | 280 f/4                  | 8.8°          | 7/6                  | 22                | E77 Series 5.5       | 208          | 1875            |
| APO-TELYT-R-MODULE-System | 280 f/2.8                | 8.8°          | 8/7                  | 22                | Series 6             | 276          | 3600            |
| APO-TELYT-R-MODULE-System | 400 f/2.8                | 6.2°          | 10/8                 | 22                | Series 6             | 344          | 5900            |
| APO-TELYT-R-MODULE-System | 400 f/4                  | 6.2°          | 9/7                  | 22                | Series 6             | 314          | 3800            |
| APO-TELYT-R-MODULE-System | 560 f/4                  | 4.5°          | 11/8                 | 22                | Series 6             | 382          | 6100            |
| APO-TELYT-R-MODULE-System | 560 f/5.6                | 4.5°          | 9/7                  | 22                | Series 6             | 374          | 3900            |
| APO-TELYT-R-MODULE-System | 800 f/2.8                | 3.1°          | 11/8                 | 22                | Series 6             | 442          | 6200            |
| VARIO-ELMAR-R             | 28-70 f/3.5-4.5          | 76-34°        | 11/8                 | 22                | E60                  | 76           | 450             |
| VARIO-ELMAR-R             | 35-70 f/4                | 64-34°        | 8/7                  | 22                | E60                  | 84           | 400             |
| VARIO-APO-ELMARIT-R       | 70-180 f/2.8             | 34-14°        | 13/10                | 22                | E77                  | 189.5        | 1870            |



## R9 ACCESSORIES

Right-Angle  
Finder



**Right-Angle Finder (LEFAR)**  
For pictures taken from any position – be they pictures taken inconspicuously “around the corner” or pictures taken from a worm’s eye perspective, looking into the finder from above. The viewfinder image can be switched to a 2x magnification..219.95

Telescope  
Ocular  
LEICA TO-R



**Telescope Ocular (LETOLR)**  
With this ocular, Leica standard, telephoto or zoom lenses can quickly be converted into telescopes with different focal lengths. In combination with a 90mm lens, it produces a magnification of 7.2x; with a 180 mm lens it creates a 14.4x magnification. Focusing is performed with the lens’ focusing mount ...324.95

Motor Winder  
R8/R9



**Motor Winder R8/R9 (LEWR8)**  
If you prefer to let your R9 advance the film, cock the shutter and rewind the film... The winder is attached to the base of the camera and it blends harmoniously with its style. Exposure series of up to 2 frames per second are possible. The Motor-Winder functions extremely quietly .....629.00

Motor Drive  
R8/R9



**Motor Drive R8/R9 (LEMDR8)**  
A high-performance drive that forms an extraordinarily well-balanced unit in combination with the R9. Its perfect ergonomics, the integrated wrist strap and the two separate release buttons for vertical and horizontal exposures lend the unit an incomparable handiness in any position. It features the choice of single frame advance or exposure sequences of up to 2 or 4½ frames per second. Automatic exposure series (bracketing) are also possible. Includes a high-power battery pack and a universal battery charger .....729.00

Macro  
Adapter R



**Macro-Adapter R (LEMARRC)**  
This intermediate ring increases the extension of R lenses by 13/16” .....459.95

### Photar Lenses and Adapter for Photar Lenses

Three lenses for use on the BR-2 Focusing Bellows with use of the Photar Lens Adapter. Corrected for magnified images. With their practically continuous magnification range of up to 18x, you can explore the fascinating field of micro-photography.



Photar Lenses and Photar-Adapter-R

12.5mm f/2.4 Photar Lens (LE12.524P) .....2,095.00  
25mm f/2.0 Photar Lens (LE252P) .....1,995.00  
50mm f/4 Photar Lens (LE504P) .....1,995.00  
Adapter for Photar Lenses (LEAPBR) .....194.95  
BR-2 Focusing Bellows (LEBR) .....908.50

### Ever-Ready Cases

Ever-Ready cases are made of elegant supple black leather.



**Ever-Ready Case for R9 (LECR8)**  
Holds an R9 camera body with a lens up to 90mm.....162.95

**Ever-Ready Case for R9 (LECR8W)**  
Holds an R9 body with a lens up to 90mm and a Motor Winder.....179.95

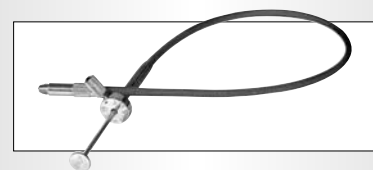

**10” Cable Release (LECR10R)**  
With locking screw .....19.50

**20” Cable Release (LECR20R)**  
With locking screw .....28.95

### Remote Control R8/R9 (LERCR8)

Enables programmed exposure series as well as remote control of the camera when used with the Motor Winder or the Motor Drive. It allows the intervals between the individual exposures as well as the number of exposures themselves to be determined freely within a wide range. Perfect for taking pictures of subjects that are difficult to approach, or to minimize vibration for close-ups and time exposure.....244.95



# KONICA MINOLTA

## X-370s

### Entry-Level Manual Focus SLR

Minolta's manual-focus X-Series SLRs have long been favorites of photography students, amateurs, and professionals alike. With the aperture-priority X-370s, you set an aperture and the camera sets the shutter speed for proper exposure. The camera has a full-metered manual exposure control for the photographer who wants to do it all. Along with the comprehensive X-Series system of lenses and accessories, the X-370s gives you system sophistication with simple, dependable operation. It's the 35mm single-lens-reflex camera system you've always wanted to own.



#### FEATURES

##### Precise, Creative Control

- ◆ A number of performance features that let you take command of every photographic opportunity. Quartz-controlled circuitry provides the consistent and dependable precision needed for outstanding results.
- ◆ Automatic exposure control with automatic exposure lock assures proper exposure under normal and complex lighting conditions. Viewfinder displays confirm operating status and exposure information. Metered manual exposure control provides unlimited creativity in aperture/shutter speed combinations.
- ◆ With a full selection of lenses and accessories, the X-370s is a system one can grow with.

##### Aperture-Priority Exposure

- ◆ Aperture-priority automatic exposure control provides accurate exposures under a wide range of lighting conditions. Simply set a desired lens aperture, and the camera selects the appropriate shutter speed steplessly from 4 sec. to 1/1000 sec. A shutter speed scale is displayed in the viewfinder.
- ◆ As the user rotates the lens' aperture selector ring, viewfinder LEDs light up next to the corresponding shutter speeds, so the user can also use this method to set exposure based on a desired shutter speed.

##### TTL Center-Weighted Average Metering

Through-the-lens exposure metering reads the entire image frame with the greatest emphasis on objects in the center. Center-weighted metering is a reliable and time-tested system used by a broad range of photographers. With the various types of metering patterns available in today's electronically sophisticated SLR cameras, center-weighted metering still remains in great demand.

##### AE Lock

By pressing the AE lock button, the user can lock the exposure reading on the main subject. Once the exposure is locked, the image can be recomposed with the subject anywhere in the viewfinder frame. AE lock is also recommended if the subject is strongly backlit or if the subject is off-center and is much lighter or dimmer than the area at the center of the frame.

##### Manual Exposure Control

With metered manual exposure control, you have full control of all aperture and shutter speed combinations. You can give the photograph more or less exposure as desired, for exposure bracketing or accurate highlight/shadow reproduction. The viewfinder displays exposure over- and under-range indicators so that ongoing metering may be monitored.

##### Manual Focusing

- ◆ For photographers who prefer a manual-focus SLR, the X-370s is an ideal choice. The bright viewfinder and acute-matte focusing screen, together with Minolta's X-Series lenses, ensure optimum picture sharpness.
- X-Series lenses are equipped with large, knurled focusing rings which provide a sure grip and just the right amount of resistance for precise, comfortable operation.
- Minolta's split-image, acute-matte focusing screen provides optimum light dispersion for a bright and clear image that is easy to focus even in low light.

##### Automatic Flash Photography

- ◆ The X-370S provides automatic flash photography when used with any of Minolta's X-Series flash units. When one of these flashes is attached to the X-370s' accessory shoe and the camera's mode selector is in any position other than 'B', the shutter speed is automatically set to 1/60 sec., the flash-sync speed. A viewfinder LED will light up next to "60" on the shutter speed scale and will blink when the flash is fully charged and ready to fire.

##### Self-Timer

- ◆ The 10-second self-timer allows the user to set up the shot and then appear in the picture. Self-timer operation is cancelable, and countdown is indicated by a flashing LED on the front of the camera body.

X-370s Body (MIX370S): Includes strap and two 1.5v LR44 batteries ....IMP. 149.95 / USA 189.95  
 CH-5 Case (MICX370N): For X370s with 50mm lens.....44.95  
 CH-5L Case (MICLX370N): for X370s with 28-70mm lens.....49.95

USA= Imported & Warrantied by Konica Minolta USA

IMP. = Imported & Warrantied by B&H (not qualified for Minolta USA rebates and warranties)



For Any Inquiries Regarding Your Order, Call Our Customer Service:  
(800) 221-5743 • (212) 239-7765 • FAX: (800) 947-2215 • (212) 239-7549

# KONICA MINOLTA

## X-370s

### Optional Accessories

#### Auto Winder G (MIAWG):

For motorized single frame advance, or continuous advance at up to 2 frames per second .....179.95

#### Wireless Controller IR-1N Set (MIIR1NS):

Lets you remotely control the X-370s from up to 200' away. Has a switch for single or continuous drive.....Call

#### Magnifier VN (MIMVN):

Ideal for close-up, macro, copying and telephoto work, enlarges the viewfinder image by 2.3x.....44.95

#### Angle Finder VN (MIFAVN):

Used to look through the finder when the camera is in hard-to-view positions, including chest level or low angles. Can be rotated to view from the top, sides or back for copy photography. Selectable 1x or 2x magnification.....119.95

#### Auto Electroflash 220X (MI220X):

A compact, bounce-head flash with a guide number of 72 feet at ISO 100 .....59.95

#### Remote Control Cord S (MIRCCS):

Remote control with 20" cable is the handy tool for shooting subjects that are difficult to approach, or to minimize vibration for close-ups and time exposure.....34.95

#### Remote Control Cord L (MIRCLL):

This remote control with 16.5' cable is the handy tool for shooting subjects that are difficult to approach, or to minimize vibration for close-ups and time exposure ....39.95

#### Cable Release II (MICR2):

Fits any camera that accepts standard mechanical cable release. Approx. 12" ...14.95

**Diopeters:** These diopter adjustment lenses provide near and far-sighted users a clear viewfinder image without their glasses.

#1 +0.5 Diopter (MIDP5X) Far sighted ...12.95

#2 +1.0 Diopter (MIDP1X) Far sighted....12.95

#3 +1.5 Diopter (MIDP1.5X) Far sighted.12.95

#4 +2.0 Diopter (MIDP2X) Far sighted....12.95

#5 +3.0 Diopter (MIDP3X) Far sighted....12.95

#6 -1.0 Diopter (MIDM1X) Near sighted .12.95

#7 -2.0 Diopter (MIDM2X) Near sighted .12.95

#8 -3.0 Diopter (MIDM3X) Near sighted.12.95

#9 -4.0 Diopter (MIDM4X) Near sighted .12.95

### Full Line of X-Series Lenses

The X-370s accepts Minolta's X-Series lenses including wide angle, normal, telephoto, macro, and zoom. Each lens is crafted with Minolta's own optical glass and subject to numerous quality control inspections at every stage of the manufacturing process.

#### 28mm f/2.8 MD (MI2828)

This very wide angle lens covers almost twice the angle of view of a 50mm standard lens. Rearfocusing system ensures a compact and lightweight design, as well as faster focusing. Circular aperture produces a more natural background. Includes a lens hood. Filter size is 49mm.....IMP. 144.95 / USA 149.95

#### 50mm f/1.7 MD (MI5017)

This lens should be in every photographer's outfit, because it is lightweight, inexpensive, and very sharp. Produces a pleasing normal perspective roughly equivalent to the human eye. Filter size is 49mm.....72.95

#### 50mm f/3.5 Macro MD

(MI5035M)

The 50mm f/3.5 macro is great for situations where one desires intimacy with the subject-such as taking pictures of a stamp, coins, fungus, etc. It is lightweight and works just as well for subjects at infinity as it does for closeup operations. Magnification is 1:1 with the supplied adapter (1:2 without). Also includes LH-2 lens case. Filter size is 55mm.....IMP. 349.95 / USA 369.95

#### 135mm f/2.8 MD (MI13528)

The 135mm lens is historically a favorite with SLR shooters, able to bring in distant scenics in much the same manner as one's eye examines a critical element of the landscape. This telephoto lens is also great at portraiture with a slightly longer perspective. Filter size is 55mm.....IMP. 144.95 / USA 149.95

#### 100mm f/4 Macro MD

(MI1004M)

A high-performance mid-telephoto lens with a maximum magnification of 1:1, the 100mm f/4 Macro is also a well-corrected medium telephoto lens ideal for portrait and close-up assignments. Includes LH-23 lens case. Filter size is 55mm.....IMP. 589.95 / USA 639.95



100mm f/4  
Macro MD

50mm f/1.7 MD

#### 28-70mm f/3.5-4.8 MD (MI287035)

A sharp standard zoom, the 28-70mm easily spreads from scenics to portraits. Filter size is 55mm.....IMP. 109.95 / USA 134.95

#### 35-70mm f/3.5-4.8 MD (MI357035)

At almost half the price of the 28-70mm, this lens provides a great value while still covering lots of ground. Filter size is 55mm .....59.95

#### 70-210mm f/4.5-5.6 MD (MI7021045)

A relatively small telephoto zoom lens, the 70-210mm features the ability to cover from short telephoto or portrait to long telephoto at 210mm. Easy one-touch operation means never having to move your hand on the lens to zoom or focus. Filter size is 49mm.....IMP. 164.95 / USA 169.95

#### 100-300mm f/5.6-6.7 MD (MI10030056)

A super-telephoto zoom lens, the 100-300 f/5.6 is easy to use for action and distant subjects. One-touch operation makes zooming and focusing a simple single step. Filter size is 55mm.....IMP. 209.95 / USA 219.95

CAMERAS & LENSES

77

ORDER & INFO. (212) 502-6340 • FAX: (212) 239-7770 (800) 947-7008  
1-800-290-6750 • www.bhphotovideo.com



# KONICA MINOLTA

## MAXXUM 50 DATE

CAMERAS & LENSES

78

### **Powerful and Stylish Entry-Level SLR**

An affordable entry-level SLR, the sleek Maxxum 50 DATE features a wide 3-point autofocus system for increased focusing confidence, Predictive Focus Control for moving subjects and Full-Auto Program for no-fuss shooting. Other features include super bright viewfinder and up to 1.7 fps continuous shooting. It has a built-in flash and incorporates Minolta's sophisticated ADI metering allowing use with Minolta's interchangeable compact and lightweight D series lenses. In addition, it uses the same type focusing screen as Minolta's top-of-the-line Maxxum 7 & 9, for exceptionally bright and clear viewfinder images.

Easy to use and comfortable to hold, controls and dials are laid out for clear, intuitive operation. The camera can be controlled with the thumb and index finger while maintaining a firm grip on the body. Additionally, a large LCD data panel on the top of the body and an illuminated viewfinder data panel clearly display camera status. Accepts all Maxxum AF lenses for outstanding photographic potential and image quality.



### **FEATURES**

#### **3-Point Continuous AF**

The Maxxum 50 DATE uses a wide autofocus area, three AF sensors, and continuous multi-dimensional autofocus to keep the subject sharp. The AF system continuously tracks subject movement in any direction as long as the shutter-release button is held partway down. For maximum performance, the center AF sensor is a crosshair type that can deliver crisp results regardless of vertical or horizontal subject pattern or contrast.

#### **Spot AF**

For creative image compositions, you can switch between the wide AF area and spot AF area to single out a subject, such as a specific person in a group. The center focus sensor is selected using the spot AF button. This feature is especially valuable when photographing children at play.

#### **Predictive Focus Control**

AF SLR cameras experience a minute delay when taking pictures because the mirror must be lifted out of the optical path. Especially with telephoto lenses, this slight delay can be significant with fast moving subjects moving toward the camera. To ensure the most precise subject focus, the Maxxum 50 DATE uses Predictive Focus Control, which keeps a clear focus on fast-moving subjects until you're ready to shoot, predicting exactly where a moving subject is going to be at the moment of shutter release and ensuring that the focus is razor sharp.

#### **Multiple Exposure**

Multiple exposure function gives you the creative power to combine multiple exposures into one frame, for stunning images.

#### **Dual-Area Metering**

The camera's exposure metering system uses two separate metering segments to read the subject and background areas. By reading both areas and biasing the exposure on the subject area, pleasing images are rendered under a wide range of shooting situations.

#### **Exposure Compensation and Bracketing**

When shooting in tricky lighting situations such as high-contrast scenes, snowy landscapes, or dark shadows, experienced photographers often use exposure compensation or bracketing to ensure they get the exposure that best renders the scene. With the Maxxum 50 DATE, exposure can be compensated up to  $\pm 3$  EV in 0.5 increments. Plus, a three bracket series can be taken in 0.3, 0.5, 0.7, or 1.0 EV increments.

### **MAXXUM 50 QD PRICING**

|   |        |
|---|--------|
| Maxxum 50 QD Camera Body (MI50D) .....  | 89.95  |
| Maxxum 50 QD Camera Kit (MI50D28100K): with 28-100mm f/3.5-5.6 AF-D lens, wide strap and CR-123 battery ..... | 164.95 |
| Maxxum 50 QD Camera Kit (MI50D2LK): Same as above plus 70-210mm f/4.5-5.6 II lens .....                       | 254.95 |
| Maxxum 50 QD Camera Kit (MI50D2LKQ): Same as above except with 75-300mm f/4.5-5.6 AF-D lens .....             | 309.90 |
| CS-7 Soft Case (MICS7): Holds a camera and up to a short telephoto lens .....                                 | 42.95  |
| EC-1300 Eyecup (MIEC1300): For Maxxum 50 .....  | 7.95   |



**EQUIPMENT LEASING AVAILABLE**

# KONICA MINOLTA

## MAXXUM 50 DATE

### Built-in Flash

The Maxxum 50 DATE's built-in flash provides coverage for lenses as wide as 28mm. Auto, flash cancel, fill-flash, and red-eye reduction modes give you worry-free flash control at your fingertips. For greater flash output and versatility, Minolta's high-powered Maxxum flashes are available as optional accessories.



### ADI Flash Metering

The ADI (Advanced Distance Integration) system delivers accurate flash metering for both internal and external Minolta flashes. When used with Minolta D lenses, the Maxxum 50 DATE's ADI flash metering achieves better, more accurate flash control than conventional flash metering. ADI combines subject distance data with the light intensity measurement from the pre-flash to control the exposure flash output. ADI uses the AF sensor (with the built-in flash), or dual-segment metering of the reflected pre-flash (with external flash units). With non-D lenses, pre-flash TTL metering is used.

### Automatic Program Mode

In the fully automatic Program (P) mode, the Maxxum 50 DATE operates just like a point & shoot camera. The camera does all the work, leaving you completely free to concentrate on the subject and scene.

### Unlimited Creative Control

The Maxxum 50 DATE can either take over control or hand over control with a full selection of exposure modes:

- In Programmed AE the camera does all the work. It analyzes subject movement and distance, lens focal length, plus subject and background brightness, then sets the optimum combination of aperture and shutter speed automatically.
- In Aperture-priority you select the lens aperture to control the depth-of-field and the camera sets the shutter speed.
- In Shutter-priority you select the shutter speed (from 1/2000 to 30 seconds) and the camera sets the aperture.
- In Manual mode you select both the aperture and shutter speed in any combination.

### Subject Program Selection

Not only is the physical layout of the Maxxum 50 DATE designed for ease of use, but the exposure and focus systems can be automatically set to capture sudden moments quickly and effortlessly. Subject Program Selection gives beginner photographers the ability to control the camera according to the subject, without a working knowledge of apertures and shutter speeds. Five modes are available, each ideally suited for a specific type of shot.

- **Portrait** – controls the aperture to produce a shallow depth-of-field to isolate the subject from the background.
- **Landscape** – controls the aperture to produce a deep depth-of-field so that the foreground and background are sharp. Ideal for travel photos.
- **Close-Up** – balances the depth-of-field with the image magnification to produce a sharp image with a defocused background.
- **Sports Action** – the AF system continually adjusts focus to follow the subject, and the AE system maximizes the shutter speed to freeze action.
- **Night Portrait** – the camera balances the flash exposure with the ambient background exposure so that both the subject and scene are accurately reproduced in the image. When the flash is turned off, beautiful pictures of night scenes can be taken.

### Conveniences

- ◆ High-contrast silver and black gives the camera a sleek look that highlights its reliability and dependability. The simple control layout and sleek silver finish also give it a sophisticated, elegant appearance.
- ◆ Equipped with the same top-quality spherical acute matte focusing screen as the Maxxum 7 & 9. It provides a bright, crisp, and clear image which is very important when working in low-light conditions or with "slow" lenses. The 0.75x viewfinder magnification enhances viewing comfort.
- ◆ For capturing action select continuous film advance. The film advances at 1.7 frames per second as long as you hold the shutter-release button down. Autofocus adjusts smoothly and precisely with each shot.
- ◆ Imprints the date and time onto the photo, when desired. Data imprinting is very useful for cataloging photographs or keeping records of important events.
- ◆ Loading film is fast and easy. Just insert the film cartridge, position the film leader, and close the camera back. The camera sets the film speed, threads the film, advances to each frame, then rewinds the film when the roll is finished. Additionally, you can activate the power rewind function anytime.
- ◆ The optional RC-3 remote control can release the shutter from up to 16' away. Ideal for self-portraits, group shots, or when taking pictures of dimly-lit scenes with the camera mounted on a tripod.



### MAXXUM 50 DATE SPECIFICATIONS

**Focus Modes:** Auto-AF (mode selected by camera), Single-shot AF, Continuous AF, Spot & Manual

**Focus Type:** 3-Point TTL phase detection with wide focus area

**Sensitivity:** EV -1 to EV18 (ISO 100)

**TTL Metering Range @ ISO 100 with f/1.4 Lens:** EV 4-20

**Shutter Speed:** 30 to 1/2000 second + Bulb, with flash sync at 1/90 second

**Exposure Compensation:** Yes

**Exposure Bracketing:** Yes

**ISO Range:** 25-3200 (DX), non-DX defaults to ISO 25, 25-1000 with flash

**Built-in Flash:** GN 39 (28mm coverage)

**Film Wind:** Single-frame or continuous advance up to 1.7 fps

**Focusing Screen:** Spherical acute matte

**Self Timer:** 10-Second delay

**Multiple Exposure:** Yes

**Power:** Two CR-2 3v lithium batteries

**Dimensions:** 5.3 x 3.6 x 2.6" WxHxD

**Weight:** 13.2 oz.

ORDER & INFO. (212) 502-6340 • FAX: (212) 239-7770 (800) 947-7008  
1-800-290-6750 • [www.bhphotovideo.com](http://www.bhphotovideo.com)



# KONICA MINOLTA

## MAXXUM 70 DATE

CAMERAS & LENSES

80

### Sophisticated Design with Performance to Match

Whether new to photography, or a seasoned amateur, the Maxxum 70 DATE has all the features to create beautiful images and a sophisticated ergonomic design to make photography intuitive and effortless. It features a Wide Center-Cross 9-point autofocus sensor for increased focusing confidence and Direct Manual Focus for fine-tuning focusing and continuous advance of up to 3 frames per second. It offers two metering modes including 14-segment honeycomb-pattern metering to ensure beautiful photos under the most difficult lighting condition. It also has a built-in flash, and features Minolta's sophisticated ADI metering, allowing use with Minolta's lightweight D series lenses. Last, the Maxxum 70 DATE offers a bright, clear viewfinder, depth-of-field preview, diopter adjustment, and 12 custom functions that let you customize camera operation.



### FEATURES

#### 9-Point AF System

Nine sensors laid out to the "rule of thirds" work in unison, giving you the flexibility to position your main subject anywhere within the wide focus frame. Center crosshair sensor ensures precise focus regardless of vertical or horizontal subject contrast. In continuous AF mode, the 9-point system takes control so you can concentrate completely on the viewfinder image. Plus, you can fine-tune the focus manually during AF shooting.

#### Predictive Focus Control

Predictive Focus Control keeps a clear focus on fast-moving subjects until you're ready to shoot, predicting exactly where a moving subject is going to be the moment the shutter is released, ensuring razor sharp focus.

#### Focus Area Illumination

When following moving subjects in the viewfinder you'll know exactly what the camera is focusing on. A local focus area or spot focus area on the viewfinder screen blinks to show that it is being used to focus the moving subject.

#### Direct Manual Focusing

Offers high performance autofocus plus the creative control of manual focus without having to change focusing modes. With D-Series lenses, Direct Manual Focus (DMF) lets you fine-tune the focus using the lens' focus ring after the focus is locked by the AF system.

#### 14-Segment Metering

Produce accurate exposures, even under back and spot lighting. The system measures light levels from 13 segments in a honeycomb pattern across the viewfinder frame, plus the background area, with emphasis on the segments surrounding the active AF sensor. Also offers spot metering to precisely meter a small portion of the subject or scene. This allows the effect of dramatic lighting to be preserved or accentuated in a photo.

#### Exposure Compensation

Exposure can be compensated up to  $\pm 3$  EV in 0.5 increments. To ensure you get the optimum exposure for tricky high-contrast scenes, a three bracket series can be made in 0.3, 0.5, 0.7, or 1.0 EV increments.

#### Super-Bright Viewfinder

The Maxxum 70 DATE is equipped with the same high-quality spherical acute matte-focusing screen as the Maxxum 7/9. The viewfinder provides a bright, clear image, which is very important when working in low-light or with slow lenses. Also, the 0.75x Magnification feature allows for comfortable viewing.

#### Subject Program Selection

Subject Program Selection is a fast, easy function that optimizes the camera for specific situations. Five modes are available, each ideally suited for a specific type of shot.

- Portrait – Produces a shallow depth-of-field to isolate the subject from the background.
- Landscape – Produces a deep depth-of-field so that the foreground and background are sharp. Ideal for travel photos.
- Close-Up – balances the depth-of-field with the image magnification to produce a sharp image of the subject with a defocused background.
- Sports Action – the AF system continually adjusts focus to follow the subject, and the AE system maximizes the shutter speed to freeze action.
- Night Portrait – balances flash exposure with the ambient background exposure so that subject and scene are accurately reproduced. When the flash is turned off, beautiful pictures of night scenes can be taken.

### MAXXUM 70 DATE PRICING

|  |                                      |
|--|--------------------------------------|
| Maxxum 70 QD Camera Body (MI70D).....  | 149.95                               |
| Maxxum 70 QD Camera Kit (MI70D28100K): With 28-100mm f/3.5-5.6 AF-D lens ..... | 199.95                               |
| Maxxum 70 QD Camera Kit (MI70D2LKQ):   | Maxxum 70 QD Camera Kit (MI70D2LKQ)  |
| With 28-100mm f/3.5-5.6 AF-D and   | With 28-100mm f/3.5-5.6 and 75-300mm |
| 70-210mm f/4.5-5.6 II lenses .....   | f/4.5-5.6 AF-D lenses .....          |
| 294.95   | 349.95                               |



[www.bhphotovideo.com](http://www.bhphotovideo.com)



# KONICA MINOLTA

## MAXXUM 70 DATE

### Unlimited Creative Power

For beginners and amateurs alike, the Maxxum 70 DATE can either takeover control or hand over control with a full selection of exposure modes.

- In the fully automatic Program (P) mode, the Maxxum 70 DATE operates just like a point & shoot camera. The camera does all the work, leaving you completely free to concentrate on the subject and scene.
- In Programmed AE the camera does all the work—it analyzes subject movement and distance, lens focal length, plus subject and background brightness, then sets the optimum combination of aperture and shutter speed automatically.
- In Aperture-priority you select the aperture and the camera sets the shutter speed.
- In Shutter-priority you select the shutter speed and the camera sets the aperture.
- In Manual mode you select both the aperture and shutter speed in any combination.
- In PA/PS Program Shift modes you can enjoy the creative benefits of aperture- or shutter-priority without having to change exposure modes. While in P mode you can quickly shift the programmed autoexposure setting to a desired aperture or shutter speed without affecting the original exposure value.

### High Performance

- ◆ For capturing action as it unfolds, select continuous film advance. The film advances at 3 frames per second as long as you hold the shutter-release button down.
- ◆ A quick press of the Depth-of-Field Preview button lets you evaluate the zone of sharp focus within your image at a given aperture; making it easy to check subject and background focus or see the extent of sharp detail in macro photography.
- ◆ Diopter adjustment lets eyeglass wearers use the Maxxum 70 DATE without wearing glasses, so you'll always see a full and crisp viewfinder image. A click-stop slide switch hidden behind the eyepiece cup adjusts the viewfinder from -2 to +1 diopters.
- ◆ The Maxxum 70 DATE is the only camera in its class to offer 15 custom functions. Now you can custom-tailor the camera to suit your preferences.

### Creative Flash Control

#### Built-In Flash:

With powerful illumination and coverage for lenses as wide as 28mm, the built-in flash puts creative flash control at your fingertips with auto, flash cancel, fill-flash, red-eye reduction and wireless remote flash control modes. For greater output and versatility, optional high-powered Maxxum flashes can be used as well.

#### ADI Flash Metering:

With Minolta D lenses, ADI flash metering combines subject distance data with light intensity data from the pre-flash to control output. ADI uses the CCD sensor (built-in flash), or 14-segment metering of the reflected pre-flash (external flash) to achieve more accurate metering than conventional TTL flash metering (when used with non-D lenses).

#### High-Speed Synch (HSS) – 1/2000 sec.

When using Maxxum HS flashes the camera is able to use flash sync shutter speeds up to 1/2000 second. High-Speed Sync allows much more control over a flash exposure, particularly under bright light conditions. When taking portraits outdoors HSS lets you use larger apertures to create a shallow depth-of-field.

#### Wireless/Remote Flash Control:

Use multiple Maxxum HS program flashes off-camera without cords or connectors. Use the 5600HS(D) and 3600HS(D). The flash control signals are sent from the Maxxum 70 DATE's built-in flash. When using the built-in flash for fill light, the ratio flash function controls the flash units to give a lighting ratio of 2:1.

### Conveniences

- ◆ Separate dials are provided for shooting mode and function selection, so changes can be made on the fly. Conveniently located focus mode button is positioned for easy operation with your right thumb, so you can switch between manual and AF modes without taking your eye away from the viewfinder.
- ◆ Built-in quartz-data back imprints date or time on the photo, making it useful for cataloging images and keeping records of important events. Can be turned off if desired.
- ◆ High-quality materials and construction provide a solid feel with sure handling:
  - Aluminum-covered top panel for a sophisticated look; Rubber-covered dials for sure, positive operation.
  - Rubberized, anti-slip grip for stable, comfortable holding; All-metal lens mount for quick, secure lens changes.
- ◆ A large LCD data panel on the top of the body and an illuminated viewfinder data panel clearly display the camera status and exposure information. Audio signals confirm focus and the self-timer countdown; the audio signals can be turned off.
- ◆ To load film, just insert the film cartridge, position the film leader, and close the camera back. The camera sets the film speed, threads the film, advances to each frame, then rewinds the film when the roll is finished. You can activate the rewind function anytime.
- ◆ Film chamber lock prevents the back cover from being inadvertently opened while there is usable film in the camera. The film chamber unlocks automatically when film rewinds.
- ◆ Optional RC-3 remote control can be used to release the camera's shutter from 16' away.

## MAXXUM 70 DATE SPECIFICATIONS

Same specs as the Maxxum 50 DATE (page 99) except:

**Focus Modes:** Auto-AF (mode selected by camera), Single-shot AF, Continuous AF, DMF Automatic AF, Manual

**Focus Type:** 9-Point TTL phase detection with center dual cross hair sensor

**TTL Metering Range @ ISO 100 f/1.4:**  
EV 1-20 in honeycomb or center-weighted metering; EV 4-20 in spot metering

**Shutter Speed:** 30 to 1/2000 second + Bulb, 1/90 flash sync; HSS (High Speed Sync) with dedicated Minolta flashes

**Built-in Flash:** GN 52 (28mm coverage)

**Film Wind:** Single-frame or continuous advance up to 3 fps

**Depth-of-Field Preview:** Yes

**Diopter Correction:** -1 to +2 built-in

# KONICA MINOLTA

## MAXXUM CAMERA ACCESSORIES

### FLASHES

The versatility and flexibility of Minolta's flash systems offer you a multitude of creative options. Experiment with light and shade using the new 2500(D), 3600HS(D) or the 5600HS(D) program flashes. Pre-flash metering assures superbly accurate exposure, and wireless synchronization achieves speeds of up to 1/8000 seconds. (D) indicates the distance encoder system. It makes features such as ADI (Advanced Distance Integration) flash metering with the Maxxum 7 or Maxxum 9 possible.



#### 2500(D) Compact Flash

The newest member of the Maxxum flash family — the progressive 2500(D) is a simple, lightweight flash compatible with the latest DiMAGE series of digital cameras. It features a guide number of 82 in feet (25 in meters) at ISO 100, and provides flash coverage for lenses as wide as 28mm. It also features an ADI (Advanced Distance Integration) flash metering and bounce flash head that can be effortlessly tilted between 0° and 90°. This can be used to create soft, indirect lighting in interiors by reflecting the flash off the ceiling. 2:1 Ratio Flash is possible when linked with a 5600HS(D). AF Illuminator automatically activates in low light and low-contrast situations

# MI2500.....109.95

#### 3600HS(D) Compact Flash

New and improved features take the Maxxum Flash 3600HS(D) to another level in lighting photography simplicity. This unit provides the maximum guide number of 118 in feet (36 in meters) at 85mm and ISO 100. It offers high-speed synchronization in all shutter speeds, and it is equipped with a built-in auxiliary light. It boasts improved flash-metering performance that reduces or eliminates the effects of background conditions, all from an ultra-compact body.

- ◆ High-Speed Sync synchronizes with all shutter speeds. This function is greatly helpful when taking a portrait picture with day-light sync.
- ◆ The 3600HS(D) achieves ADI (Advanced Distance Integration) flash metering by combining TTL flash metering and guide number control for the highest level of control accuracy.

# MI3600HS.....159.95



#### 5600HS(D) High Powered Compact Program Flash

Enhance your indoor and night photography. The 5600HS (D) offers a maximum guide number of 1833'4" at 85mm and ISO 100, and it aligns to all speeds of the high-speed shutter. This coupled with its compact design, increases its effectiveness and versatility.



- ◆ High-Speed Sync (HSS) synchronizes with all shutter speeds. Very helpful when taking a portrait picture with day-light sync.
- ◆ Innovative bounce flash head conveniently tilts 10° downward, 90° upward, 90° clockwise and 180° counter-clockwise for optimum freedom in composing your images.
- ◆ The flash provides the following custom functions to expand photographic control: Wireless channel setting, Choice of units for distance display, Auto-power off-time setting, Wireless auto-power off-time setting, and Exposure mode settings for manual flash.
- ◆ ADI (Advanced Distance Integration) flash metering calculates a guide number according to the distance from subject, ambient light and pre-flash reflectivity. This provides a flash metering performance that reduces or eliminates the effects of background conditions or your subject's reflectance, for a level of control accuracy never before possible.

# MI5600HS.....299.95

# KONICA MINOLTA

## MAXXUM CAMERA ACCESSORIES

### FLASHES

#### Macro Ring Flash 1200 with Macro Flash Controller

A flexible and creative macro flash system combining the Macro Ring Flash 1200 and the Macro Flash Controller. With four flashtubes, the Macro Ring 1200 is ideally suited for macro shooting in medical, scientific and nature photography where shadows need to be eliminated. Each of the four flashtubes can also be set individually to achieve a variety of lighting effects and create natural depth in the image.

MI1200MRFS .....409.95



#### Macro Twin Flash 2400 with Macro Flash Controller

A flexible and creative macro flash system combining the Macro Twin Flash 2400 and the Macro Flash Controller. The Macro Twin Flash 2400 provides enormous flexibility in light source positioning. It includes twin flash units that feature adjustable flash heads mounted in front of the lens, and a variety of flash positions which can be achieved when used in combination with the extendable twin flash arms. The Macro Twin Flash 2400 allows photographers to achieve a vast range of creative lighting techniques, making it ideally suited for close-up nature photography and photographing small objects.

The Macro Flash Controller controls the operation of the Macro Twin Flash 2400 as well as the Macro Ring Flash 1200 to offer accurate flash metering. The controller features a 7-step Power Level Function and four custom functions.

MI2400MTFS .....519.95

### FLASHES AT A GLANCE

|                      | 2500(D)<br>Compact Flash | 3600HS(D)<br>Compact Flash | 5600HS(D)<br>Compact Flash | 1200/2400<br>Macro Ring Flash |
|----------------------|--------------------------|----------------------------|----------------------------|-------------------------------|
| Program Reset        | Yes                      | Yes                        | Yes                        | Yes                           |
| Auto Power Zoom      | -                        | Yes                        | Yes                        | -                             |
| Ratio Flash          | No                       | No                         | No                         | -                             |
| ADI Flash Metering   | Yes                      | Yes                        | Yes                        | -                             |
| High Speed Sync      | No                       | Yes                        | Yes                        | -                             |
| Slow Shutter Sync    | Yes                      | Yes                        | Yes                        | Yes                           |
| Modeling Flash       | -                        | -                          | Yes                        | Yes                           |
| Multiple Flash       | -                        | -                          | Yes                        | N/A                           |
| Manual Flash Control | -                        | N/A                        | Yes                        | -                             |
| AF illuminator       | No                       | No                         | No                         | N/A                           |
| Flash Indicator      | Yes                      | Yes                        | Yes                        | Yes                           |

#### TC-1000 Triple Connector (MITC1000)

A multiple flash mounting accessory to connect up to three flashes to the camera. The 3600HS(D) is connected to the TC-1000 with an OS-1100 off-camera shoe and an extension cable. The 5600HS(D) is connected with an extension cable .....46.95



#### Off-Camera Cable (MIOC1100)

Used in combination with the off-camera shoe OS-1100 to use the 3600HS(D) removed from the camera body, or can be used by itself to connect the 5600HS(D) directly to the camera. Since the flash can be positioned at any angle to the subject, special light-dark contrast effects, close-up photography, and precise control of the lighting balance are possible .....36.95

#### Off-Camera Shoe (MIOS1100)



To use the Maxxum Flash 5600HS(D) separated from the camera, mount the flash on the off-camera shoe and connect the flash and camera with the off-camera cable OC-1100.....39.95

#### Cable CD (MICCD)

A cable with plugs on each end that connect one flash to another via 4-pin sync sockets .....39.95

#### Bounce Reflector V-Set (MIBR5S)

This compact accessory attaches to the 5600HS and 3600HS flash and provides a desirable bounce surface for a soft, natural effect, even outdoors. Minolta direct TTL autoflash metering controls flash duration for proper exposure.....34.95



#### External Battery Pack (MIBPEP2)

An ultra-compact and portable external battery pack can be used to power the 5600HS(D). Requires 6 AAA batteries.....129.95

# KONICA MINOLTA

## MAXXUM AUTOFOCUS LENSES

### ULTRA WIDE ANGLE LENSES

#### **AF 16mm f/2.8 Fisheye** (MI1628AF)

This fisheye covers a diagonal angle of view of 180° from corner to corner of the picture. It can autofocus landscape, architectural and interior photographs. A special lens hood forms an integral part of the lens barrel. Has a built-in lens hood and four filters. ....  
IMP. 819.95 / USA 859.95

#### **AF 20mm f/2.8** (MI2028AFQ)

This ultra wideangle lens provides great depth-of-field and emphasizes perspective. Rear-focusing system ensures quick, precise focusing and corrects close-focus aberrations. Rubber focus ring provides comfortable manual focusing operation. Includes a lens hood. Filter size is 72mm .....IMP. 549.95 / USA 569.95

#### **AF 24mm f/2.8** (MI2428AFQ)

Lightweight ultra wide-angle lens provides precise auto focusing while virtually eliminating close-focus aberrations with a rear-focusing floating optical element. The 7-blade aperture provides round, natural-looking highlights with its circular opening. Includes a lens hood. Filter size is 55mm .....IMP. 349.95 / USA 369.95



USA= Imported & Warrantied by Konica Minolta USA

IMP. = Imported & Warrantied by B&H (not qualified for Minolta USA rebates and warranties)

### WIDE ANGLE and STANDARD LENSES



#### **AF 28mm f/2.0** (MI282AF)

A sharp, bright wideangle lens, the 28mm f2.0 works exceptionally well in low light. The focusing ring is wide and well dampened and the front of the lens doesn't move during autofocus. Includes a lens hood. Filter size is 55mm .....IMP. 449.95 / USA 499.95

#### **AF 28mm f/2.8** (MI2828AF)

An economical lightweight lens, this wide-angle features diminutive size and sharp 5-element optical formula that produces outstanding results in all but the darkest of handheld conditions. Has a built-in hood. Filter size is 49mm .....IMP. 194.95 / USA 204.95

#### **AF 35mm f/1.4 G** (MI3514AFQ)

The 35mm f/1.4 features a circular aperture that produces a more round and natural-looking background. Its rear focusing and ground aspheric element ensures superb sharpness and high contrast. This lens accommodates lots of background and conveys atmosphere, making it ideal for wideangle portrait photography. Filter size is 55mm .....IMP. 1029.95 / USA 1069.95

#### **AF 35mm f/2** (MI352AFQ)

Popular lens with a bright aperture, the 35mm f/2 is ideal for a wide range of situations. Manual focus ring is rubberized and wide with dampening. Includes a lens hood. Filter size is 55mm .....Call

#### **AF 50mm f/1.7** (MI5017AF)

Standard lens that duplicates the natural angle of the human eye. Outstanding cost performance for a wide range of situations. 49mm filter size .....IMP. 76.95 / USA 79.95

#### **AF 50mm f/1.4** (MI5014AF)

With large aperture this lens offers versatility, wide coverage and unmatched cost performance. Includes a lens hood. Filter size is 55mm .....IMP. 239.95 / USA 249.95



For Any Inquiries Regarding Your Order, Call Our Customer Service:  
(800) 221-5743 • (212) 239-7765 • FAX: (800) 947-2215 • (212) 239-7549

# KONICA MINOLTA

## MAXXUM AUTOFOCUS LENSES

### MACRO LENSES

#### **AF 50mm f/2.8 Macro (D)** (MI5028MAFL)

This standard macro lens comes with a double-floating element focusing design, and focuses from infinity to a 1:1 magnification ratio without the aid of attachments. The seven-blade circular aperture produces a softer, more natural-looking background. A focus-hold button and focus-range limiter enhance focusing operations. Also supports Minolta's ADI (Advanced Distance Integration) flash metering by providing precise distance information from the built-in distance encoder. This allows highly accurate flash-metering performance to be achieved. Filter size is 55mm.....IMP. 359.95 / USA 369.95

#### **AF 50mm f/3.5 Macro** (MI5035MAF)

Compact and lightweight, this lens features a floating lens element focusing design that virtually eliminates aberrations in close-focus situations. This lens allows you to focus from infinity to a 1:2 magnification ratio. Filter size is 55mm.....Call

#### **AF 100mm f/2.8 Macro (D)** (MI10028MDAF)

A high-performance mid-telephoto lens with continuous macro capability as close as 0.35m, and 1:1 magnification, the AF 100mm f/2.8 (D) provides excellent operation for auto and manual focusing. Auto Clutch Mechanism doesn't rotate the focusing ring during AF drive, making the lens easy to hold and balance. Focus-hold button lets you stop the AF drive and release the shutter at the desired position. The button can also be customized to provide different functions when the lens is attached to a camera with custom functions. In manual, the wide focus ring is easy to control, and rotates smoothly. Ideal for shooting flowers or small animals, the lens also delivers fine portrait and landscape results. The "double floating" focusing method corrects aberrations to provide fine images at any distance. In addition, the 9-blade, circular aperture produces a smooth and natural rendition of defocused images, as well as nearly circular shapes of point sources of light such as a reflection of the morning dew. Supports Minolta's ADI flash metering by providing precise distance information from the built-in distance encoder. This allows highly accurate flash-metering to be achieved. Includes a lens hood. Filter size is 55mm .....IMP. 549.95 / USA 569.95



AF 50mm f/2.8 Macro (D)

AF 50mm f/3.5 Macro

AF 100mm f/2.8 Macro (D)



AF 200mm f/4 Macro APO G

AF Macro Zoom 3x-1x f/1.7-2.8

#### **AF 200mm f/4 Macro APO G** (MI2004MAAF)

The AF 200mm f/4 Macro APO G offers continuous macro capability as close as 0.5m and 1:1 magnification. Featuring AD glass and a circular aperture, it ensures excellent performance with color correct images and a natural defocusing effect. Designed for serious photographers wanting closer wildlife pictures, the lens is equipped with a focus-hold button, focus-range limiter, and detachable tripod-mounting collar to give you perfect control in telephoto macro photography. In addition, the lens provides a sure grip by the development of a mechanism which automatically makes the focusing ring inactive in the camera's AF mode, and activates it in MF mode. There is no cumbersome operation to select the focus mode on the lens to match the camera's focus mode, letting you concentrate on the viewfinder images at a critical moment. Includes a lens hood and case. Filter size is 72mm.....IMP. 859.95 / USA 899.95

#### **AF Macro Zoom 3x-1x f/1.7-2.8** (MBX1XM)

This is the world's first macro zoom lens with a magnification ratio capability from 1:1 to 3:1. It provides handy motorized operation and a double-floating element design that eliminates aberrations, even with its 3x f/1.7 setting .....IMP. 1499.95 / USA 1599.95

CAMERAS & LENSES

85

ORDER & INFO. (212) 502-6340 • FAX: (212) 239-7770 (800) 947-7008  
1-800-290-6750 • www.bhphotovideo.com



# KONICA MINOLTA

## MAXXUM AUTOFOCUS LENSES

### PORTRAIT LENSES

#### **AF 85mm f/1.4 G (D)** (MI8514DAF)

This versatile lens features a wide focusing ring for comfort and better control, a non-rotating focusing ring while in AF, and a focus hold button for easy operation. Ideal for portrait and indoor photography, the 85mm f/1.4 has a circular aperture and floating focusing system to give you beautiful defocused images as well as high-resolution images. Also supports Minolta's ADI (Advanced Distance Integration) flash metering by providing precise distance information from the built-in distance encoder. This allows highly accurate flash-metering performance to be achieved. Includes lens hood and hard case. Filter size is 72mm .....IMP. 649.95 /USA 669.95



#### **STF 135mm f/2.8 [T45]** (MI13528STF)

The STF 135mm f/2.8 [T4.5] is an innovative lens that produces perfectly defocused image areas, as well as superb picture sharpness. Until now, imperfections in defocusing effects, such as a defocused image dissolving into cluttered unsharpness have always been a source of headaches for photographers.

The STF 135mm f/2.8 [T4.5] eliminates these imperfections, and realizes a smooth transition from focused to defocused areas with unsurpassed defocusing effects both in foreground and background.

Lens construction includes an apodization filter to implement a natural shift from focused to defocused areas. As a result, the original outline of the subject remains clear, the image is provided with depth, and the subject is visually outstanding. The lens also minimizes aberrations that deteriorate the quality of defocused image areas. 10-blade circular aperture also contributes to smooth rendition of defocused highlights, such as blurred points of sunlight coming through forage. Includes hood and hard case. Filter size is 72mm .....IMP. 929.95 /USA 949.95

#### **f/2.8 Soft Focus** (MI10028AF)

This unique lens sharply focuses your subject and provides a soft surrounding effect that can be chosen at or between three settings: The "2" setting (top) provides a maximum level softness around the edge of the subject. The "0" setting (bottom) switches off the soft effect, allowing the lens to be used as a normal 100mm with high resolution and contrast throughout the picture. Includes hood and hard case. Filter size is 55mm .....IMP. 589.95 /USA 619.95

### TELEPHOTO LENSES

#### **AF 200mm f/2.8 APO G** (MI20028AAF)

The AF 200mm f/2.8 uses AD (anomalous-dispersion) glass elements to provide apochromatic correction. The lens produces images with excellent color balance and sharpness from 4.9' to infinity, while its internal focusing system provides high-speed autofocus. In addition, its large maximum aperture enables shooting in low-light situations. Has a focus-hold button conveniently located on the side of the lens barrel. Lens comes with a protective front filter and lens hood. Filter size is 72mm .....IMP. 869.95 /USA 889.95

#### **AF 300mm f/2.8 APO G (D) SSM** (MI30028DAF)

The perfect synthesis of optical, computer and mechanical engineering, the 300mm f/2.8 APO G (D) SSM features thirteen finely crafted elements, including three AD (anomalous dispersion) lenses to virtually eliminate lens aberrations and curvature of field. The result is sharp images across the entire film area at all apertures as well as a smooth defocused image outside the depth of field. High-quality multi-coatings and internal baffles reduce flare to preserve contrast. Computer controlled functions such as DMF, focus-range limiters, prefocus, and focus hold make it the perfect tool for wildlife and sports. Includes a 360° rotating collar, lens hood, trunk case and 42mm clear filter .....IMP. 4599.00 /USA 4699.00



# KONICA MINOLTA

## MAXXUM AUTOFOCUS LENSES

### TELEPHOTO & SUPER TELEPHOTO LENSES

#### **AF 300mm f/4 APO G** (MI3004AAF)

This compact and lightweight telephoto lens uses two AD (anomalous dispersion) glass elements to provide apochromatic correction for high quality images. Its circular aperture provides a natural-looking background, while its internal focusing system assures you of high-speed autofocus. A focus-hold button and focus-range limiter improve speed shooting performance. Includes lens hood, trunk case and rear and front filters.....IMP. 899.95 /USA 949.95



#### **AF 400mm f/4.5 APO G** (MI40045AAF)

The ideal telephoto lens for sports and wildlife subjects. Its two AD (anomalous-dispersion) glass elements correct chromatic aberrations, and its circular aperture gives you a natural looking background. The focus hold button and focusing range ring improve speed-shooting performance. Includes lens hood, trunk case and rear protective filter .....IMP. 1829.95 /USA 1899.95

#### **AF Reflex 500mm f/8** (MI5008AF)

The AF 500mm f/8 is the world's first autofocus reflex telephoto lens. Thanks to its spacesaving catadioptric design, it is compact and lightweight. A convenient built-in focus-hold button is located at the side of the lens barrel for quick and sure operation. The lens can be used with any Maxxum body in manual-focusing mode (autofocusing and focus indicator do not function). Includes LH-1076 case, Normal & ND4x filters and built-in lens hood .....IMP. 549.95 /USA 569.95



#### **AF Reflex 600mm f/4 G APO** (MI6004AAF)

This extreme-telephoto lens features high-speed autofocus with its internal focusing system and uses AD (anomalous-dispersion) glass to correct color aberrations. A focus-hold button and focus-range limiter are provided for faster focusing, while a protective filter is built into the lens barrel. The 600mm focal length is ideal for capturing wildlife and sports photography. Includes lens hood, trunk case and 42mm drop-in filters (Y52, ND4x, Normal, O56, R60). Weighs 12 lbs.....IMP. 6995.95 /USA 7499.95

USA= Imported & Warrantied by Konica Minolta USA

IMP. = Imported & Warrantied by B&H (not qualified for Minolta USA rebates and warranties)

#### **1.4x and 2x Tele Converters**

Two apochromatic teleconverters are designed for use with the APO lenses: AF 1.4x Tele Converter APO (D) and AF 2x Tele Converter APO (D). These accessories increase the power of the lenses while allowing the use of the automatic Maxxum camera and lens systems. The 1.4x teleconverter creates the equivalent of a 98 - 280mm f/4.0 lens, and the 2x converter transforms the AF 70-200mm lens into an amazing 140 - 400mm f/5.6 telephoto zoom, fast enough to handhold with ISO 100 film in broad daylight. And the 1.4x converter creates the equivalent of a 420mm f/4.0 lens, while the 2x converter transforms the 300mm lens into an amazing 600mm f/5.6 super-telephoto.

AF 1.4x Tele Converter APO (D) (MI1.4XAF) .....IMP. 359.95 /USA 369.95

AF 2x Tele Converter APO (D) (MI2XAAF).....IMP. 369.95 /USA 389.95



CAMERAS & LENSES

87

ORDER & INFO. (212) 502-6340 • FAX: (212) 239-7770 (800) 947-7008  
1-800-290-6750 • www.bhphotovideo.com



# KONICA MINOLTA

## MAXXUM AUTOFOCUS LENSES

### WIDE ANGLE ZOOM LENSES



#### **AF 17-35mm f/3.5 G** (MI173535AF)

This flexible zoom gives you the freedom to compose in the super wideangle range. It is a large-aperture, super-wide angle zoom lens with very high image quality, and is constructed using aspherical elements and AD glass to ensure highly descriptive performance and minimize distortion—even at maximum wide angle at full-open aperture. Designed for people that understand image quality, super-wide angle of view is ideal for capturing the extensiveness of a scene in landscape and architecture/interior photography. Includes lens hood and hard case. Filter size is 77mm .....IMP. 1479.95 /USA 1499.95

#### **AF 20-35mm f/3.5-4.5** (MI203535AF)

A compact, wide angle zoom lens with high image quality, the 20-35mm is constructed using an aspheric element to ensure a balanced descriptive performance throughout its focal range. Aspheric elements also minimize vignetting, to produce beautiful images at large aperture settings. Like the 17-35mm, it's super-wide angle view is ideal for capturing the extensiveness of a scene in landscape and architecture/interior photography. Includes lens hood and hard case. Filter size is 72mm .....IMP. 469.95 /USA 479.95

#### **AF 24-50mm f/4** (MI24504AF)

This lens is ideal for scenery or interior situations. Its wide-to-medium coverage allows the user to photograph a variety of subjects from landscape and group shots to snapshots. Its compound -aspheric elements provide a compact design. Includes lens hood. Filter size is 55mm .....IMP. 249.95 /USA 269.95

#### **AF 24-85mm f/3.5-4.5** (MI248535AF)

The AF 24-85mm f/3.5-4.5 is a high image quality, 3.5x standard zoom lens. Yet, although this is a standard lens, its super-wide 24mm focal length provides possibilities for creative composition. It includes two compound aspheric elements to ensure a high degree of sharpness by overcoming field curvature (reduces aberration that are common at wide focal lengths). The aspheric elements also contribute greatly to the overall compactness of the lens. Internal focusing system enables autofocusing from infinity down to 19.7" Includes lens hood. Filter size is 62mm .....IMP. 219.95 /USA 229.95

#### **AF 24-105mm f/3.5-4.5 (D)** (MI2410535DAF)

An ultra-compact, standard 4.3x wide angle zoom, the AF 24-105mm f/3.5-4.5 (D) offers exceptional range with excellent focusing operation and high-quality images throughout the zooming range. Minolta's Auto Clutch Mechanism which does not rotate the focusing ring during AF drive lets you easily hold the camera in good balance.

In manual focus, the wide, well dampened ring is easy to control and rotates smoothly. Three aspheric surfaces (two elements) reduce the total number of lens elements and shorten the length of the optical system. Optimally arranged, these aspheric lenses reduce spherical aberration, sagittal flare and coma. In addition, the lens features a circular aperture diaphragm for beautiful rendition of defocused image areas. It also supports Minolta's ADI (Advanced Distance Integration) flash metering by providing precise distance information from the built-in distance encoder. This allows highly accurate flash-metering performance to be achieved. It includes a large, petal-type lens hood for optimal light shielding. Filter size is 62mm .....IMP. 339.95 /USA 369.95





# KONICA MINOLTA

## MAXXUM AUTOFOCUS LENSES

### WIDE ANGLE ZOOM LENSES

#### AF 28-100mm f/3.5-5.6 (D)



Lightweight and compact, this lens provides a 3.5x zoom range, ideal for landscape, portrait and travel photography, all in one lens. Also supports Minolta's ADI (Advanced Distance Integration) flash metering by providing precise distance information from the built-in distance encoder for highly accurate flash-metering performance. Includes lens hood. Available in black or silver. Filter size is 55mm.

**Black (MI2810035DB) or Silver (MI2810035D) ....IMP. 84.95 /USA 89.95**



### AF ZOOM (D) LENSES

Although they are designed to provide optimum image quality when used with the digital Maxxum 7D SLR, these lenses offer superior handling characteristics that make them ideal in a diverse range of shooting situations. They provide unparalleled creative control because of their circular apertures. Using a round aperture enhances the defocused areas of an image with smoother, more natural looking tone gradations.

#### Zoom Super Wide Angle AF 17-35mm f/2.8-4 (D) Autofocus Lens (MI173528AF)

A large-aperture, super-wide angle zoom lens with high image quality. The equivalent focal length with a digital SLR camera is 25.5 - 52.5mm. It is constructed using aspherical elements and AD glass to ensure highly descriptive performance which minimize distortion at the widest angle of view, and produce beautiful images at the largest aperture.....499.95



#### Zoom Wide Angle-Telephoto AF 28-75mm f/2.8 (D) Autofocus Lens (MI287528AF)

A compact standard zoom-range large-aperture lens, ideal for everyday use. Its compactness makes it look and feel like a standard zoom lens, yet provides the versatility that a fast constant maximum aperture offers. The equivalent focal length with a digital SLR camera is 42 - 112.5mm. This lens is constructed using aspherical elements and AD glass to ensure highly descriptive performance. These optics minimize distortion at the widest angle of view, and they produce beautiful images at the largest aperture .....409.95



CAMERAS & LENSES

89

USA= Imported & Warrantied by Konica Minolta USA

IMP. = Imported & Warrantied by B&H (not qualified for Minolta USA rebates and warranties)

### TELEPHOTO ZOOM LENSES

#### AF 70-200mm f/2.8 APO G (D) SSM (MI7020028DAF)

This lens employs supersonic-wave motor (SSM) technology for quieter, smoother AF operation, and uses the finest optical glass to provide sharp, color-free images across the entire film area at all apertures. It uses 19 finely crafted elements, including four AD (anomalous dispersion) lenses, to virtually eliminate aberrations and curvature of field. High-quality multi-coatings increase transmittance and reduce flare to preserve contrast. 9-blade circular aperture design keeps the defocused image of point light sources outside the depth of field round between f/2.8 and f/5.6. For convenience, three focus hold buttons let you lock the focus at the press of a button. Two DMF (Direct Manual Focus) modes give exacting control over the AF system. Standard DMF allows the photographer to fine tune the focus after the AF system has locked onto the subject. Full-time DMF gives the photographer access to manual focus control at any time by simply turning the focusing ring. The lens includes a removable tripod collar that rotates 360° so that the camera and lens can be orientated in any position when mounted from above or below. It also includes a lightweight, but durable, petal-type lens hood lined with velvet to reduce flare. The hood also has a covered polarizing-filter window so that a polarizing filter can be rotated without having to remove the hood from the lens. It includes padded lens case. Filter size is 77mm ..... IMP. 1799.95 /USA 1849.95



ORDER & INFO. (212) 502-6340 • FAX: (212) 239-7770 (800) 947-7008  
1-800-290-6750 • www.bhphotovideo.com



# KONICA MINOLTA

## MAXXUM AUTOFOCUS LENSES

CAMERAS & LENSES

90

### TELEPHOTO ZOOM LENSES

#### **AF 70-210mm f/4.5-5.6 II** (MI70210452AF)

With a 3x zoom ratio, the AF 70-210mm f/4.5-5.6 II is ideal for a portrait, sports, and other telephoto shots. It offers exceptional image quality supported by well-considered optical design. The lens focuses continuously from infinity down to 1.1m, providing the maximum magnification of 0.26X without the need for a macro setting. Furthermore, the widened, knurled zooming and focusing rings offer absolute control and balanced holding. Includes lens hood. Filter size is 49mm .....IMP. 94.95 /USA 99.95  
Also available in silver (MI7021045AFS) .....IMP. 99.95 /USA 114.95

#### **AF 75-300mm f/4.5-5.6 (D)** (MI7530045DAF)

This 4x zoom lens offers very wide coverage from short telephoto to full 300mm telephoto. It provides a continuous telephoto macro capability with autofocus and a maximum 1/4 life-size magnification ratio. Also supports Minolta's ADI (Advanced Distance Integration) flash metering by providing precise distance information from the built-in distance encoder. This allows highly accurate flash-metering performance to be achieved. Includes lens hood. Filter size is 55mm ...IMP. 139.95 /USA 149.95  
Also available in black (MI7530045DAB) .....IMP. 139.95 /USA 149.95

#### **AF 80-200mm f/2.8 APO G** (MI8020028AAQ)

This lens uses AD glass to reduce chromatic aberration to a level that places it in the distinguished "apochromat" class, while f/2.8 maximum aperture provides performance comparable to fixed focal length lens. Includes a tripod collar, lens hood and case. Filter size is 72mm .....Call



AF 70-210mm  
f/4.5-5.6 II

AF 75-300mm  
f/4.5-5.6 (D)

AF 80-200mm f/2.8 APO G



▲  
AF 100-300mm  
f/4.5-5.6 (D) APO

AF 100-400mm  
f/4.5-6.7 APO ▶

#### **AF 100-300mm f/4.5-5.6 (D) APO** (MI10030045DA)

Compact and lightweight, the AF 100-300mm f/4.5-5.6 (D) APO is an easy to carry 3X telephoto zoom that produces high-quality images. Two low-dispersion AD glass elements correct the chromatic aberrations that normally plague telephoto lenses. The lens provides excellent operation for auto and manual focusing. The focus-hold button allows for stopping AF drive and releasing the shutter at the desired position. The button can also be customized to provide different functions such as continuous autofocus or central sensor selection when attached to a camera body with Custom Functions. In manual focus, the wide ring is easy to control, and rotates smoothly. Supports ADI flash metering by providing precise distance information from the built-in distance encoder, thus ensuring accurate flash-metering. Includes lens hood. Filter size is 55mm .....IMP. 369.95 /USA 389.95

#### **AF 100-400mm f/4.5-6.7 APO** (MI10040045AA)

An ultra-telephoto yet light and compact 400mm zoom lens with wide-ranging 4x zoom, the AF 100-400mm features two AD (anomalous-dispersion) glass elements to correct chromatic aberrations, and circular aperture to provide a natural-looking background. The focus hold button is conveniently located on the lens barrel's side. Includes lens hood. Filter size is 55mm .....IMP. 599.95 /USA 699.95

USA= Imported & Warrantied by Konica Minolta USA

IMP. = Imported & Warrantied by B&H (not qualified for Minolta USA rebates and warranties)



[www.bhphotovideo.com](http://www.bhphotovideo.com)

# KONICA MINOLTA

## MAXXUM AUTOFOCUS LENSES

| Lenses                                 | Elements/<br>Groups | Angle of<br>View                    | Minimum<br>Focus                           | Minimum<br>Aperture    | Filter<br>(dia.) | Dimensions<br>(dia. x length) | Weight          |
|--|---------------------|-------------------------------------|--|------------------------|------------------|-------------------------------|-----------------|
| AF Power Zoom 35-80mm f/4-5.6 Macro*   | 8/8                 | 68°-30°                             | 1.6'                                       | f/22-32                | 49mm             | 2 1/8 x 2 1/8"                | 6 1/8 oz.       |
| AF 16mm f/2.8 Fisheye                  | 11/8                | 180°                                | 0.7'                                       | f/22                   | integral         | 2 1/8 x 2 1/8"                | 14 1/8 oz.      |
| AF 20mm f/2.8                          | 10/9                | 94°                                 | 0.8'                                       | f/22                   | 72mm             | 3 1/8 x 2 1/8"                | 10 oz.          |
| AF 24mm f/2.8                          | 8/8                 | 84°                                 | 0.8'                                       | f/22                   | 55mm             | 2 1/8 x 1 1/8"                | 7 1/8 oz.       |
| AF 28mm f/2                            | 9/9                 | 75°                                 | 1'   | f/22                   | 55mm             | 2 1/8 x 1 1/8"                | 10 1/8 oz.      |
| AF 28mm f/2.8                          | 5/5                 | 75°                                 | 1'   | f/22                   | 49mm             | 2 1/8 x 1 1/8"                | 6 1/8 oz.       |
| AF 35mm f/1.4 G                        | 10/8                | 63°                                 | 1'   | f/22                   | 55mm             | 2 1/8 x 3"                    | 16 1/8 oz.      |
| AF 35mm f/2                            | 7/6                 | 63°                                 | 1'   | f/22                   | 55mm             | 2 1/8 x 1 1/8"                | 8 1/8 oz.       |
| AF 50mm f/1.4                          | 7/6                 | 47°                                 | 1.5'                                       | f/22                   | 55mm             | 2 1/8 x 1 1/8"                | 8 1/8 oz.       |
| AF 50mm f/1.7                          | 6/5                 | 47°                                 | 1.5'                                       | f/22                   | 49mm             | 2 1/8 x 1 1/8"                | 6 oz.           |
| AF 85mm f/1.4 G (D)                    | 7/6                 | 28° 5'                              | 2.8'                                       | f/22                   | 72mm             | 3 1/8 x 2 1/8"                | 19 1/8 oz.      |
| AF 200mm f/2.8 APO G                   | 8/7                 | 12° 30'                             | 4.9'                                       | f/32                   | 72mm             | 3 1/8 x 5 1/8"                | 27 1/8 oz.      |
| AF 300mm f/2.8 APO G (D) SSM           | 11/9                | 8° 10'                              | 8.2'                                       | f/32                   | integral         | 5 1/8 x 9 1/8"                | 87 1/8 oz.      |
| AF 300mm f/4 APO G                     | 9/7                 | 8° 10'                              | 8.2'                                       | f/32                   | 42mm             | 3 1/8 x 8 1/8"                | 49 1/8 oz.      |
| AF 400mm f/4.5 APO G                   | 9/7                 | 8° 10'                              | 9.8'                                       | f/32                   | integral         | 4 1/8 x 10 1/8"               | 67 1/8 oz.      |
| AF 600mm f/4 APO G                     | 10/9                | 4° 10'                              | 20'  | f/32                   | integral         | 6 1/8 x 17 1/8"               | 194 oz.         |
| AF Reflex 500mm f/8 (1)                | 7/5                 | 5°                                  | 13'  | —                      | integral         | 3 1/8 x 4 1/8"                | 23 1/8 oz.      |
| <b>AF 17-35mm f/2.8-4 (D)</b>          | <b>11/14</b>        | <b>104°-63°</b>                     | <b>11.8"</b>                               |                        | <b>77mm</b>      | <b>3.3"x3.5"</b>              | <b>15.1 oz.</b> |
| AF 17-35mm f/3.5 G                     | 15/12               | 104°-63°                            | 0.98'                                      | f/22                   | 77mm             | 3 1/8 x 3 1/8"                | 21 1/8 oz.      |
| AF 20-35mm f/3.5-4.5                   | 13/11               | 94°-63°                             | 1.6'                                       | f/22-27                | 72mm             | 3 1/8 x 2 1/8"                | 11 1/8 oz.      |
| AF 24-50mm f/4                         | 7/7                 | 84°-47°                             | 1.1'                                       | f/22                   | 55mm             | 2 1/8 x 2 1/8"                | 10 1/8 oz.      |
| AF 24-85mm f/3.5-4.5                   | 14/12               | 84°-29°                             | 1.6'                                       | f/22-27                | 62mm             | 2 1/8 x 2 1/8"                | 14 1/8 oz.      |
| <b>AF 28-75mm f/2.8 (D)</b>            | <b>14/16</b>        | <b>75°-32°</b>                      | <b>13"</b>                                 |                        | <b>67mm</b>      | <b>2.9"x3.7"</b>              | <b>1.1 lb</b>   |
| <b>AF 28-100mm f/3.5-5.6 (D)</b>       | <b>8/10</b>         | <b>75°-24°</b>                      | <b>1.6'</b>                                |                        | <b>55mm</b>      | <b>2.6"x3.1"</b>              | <b>8.5 oz.</b>  |
| AF 24-105mm f/3.5-4.5 (D)              | 12/11               | 84°-23°                             | 1.6'                                       | f/22-27                | 62mm             | 2 1/8 x 2 1/8"                | 13 1/8 oz.      |
| <b>AF 70-200mm f/2.8 APO G (D) SSM</b> | <b>15/19</b>        | <b>34°-12°</b>                      | <b>3.9'</b>                                |                        | <b>77mm</b>      | <b>3.4"x7.7"</b>              | <b>3 lb</b>     |
| AF 70-210mm f/4.5-5.6 II               | 10/10               | 34°-12°                             | 3.6'                                       | f/22-27                | 49mm             | 2 1/8 x 3 1/8"                | 11 1/8 oz.      |
| AF 70-300mm f/4.5-5.6 II               | 13/10               | 32°-8° 10'                          | 4.9'                                       | f/32-38                | 55mm             | 2 1/8 x 4 1/8"                | 17 1/8 oz.      |
| <b>AF 75-300mm f/4.5-5.6 (D)</b>       | <b>10/13</b>        | <b>32°-8°</b>                       | <b>4.9'</b>                                |                        | <b>55mm</b>      | <b>2.8"x4.8"</b>              | <b>1.01 lb</b>  |
| AF 100-300mm f/4.5-5.6 APO D           | 11/10               | 24°-8° 2'                           | 4.9'                                       | f/32-38                | 55mm             | 2 1/8 x 4"                    | 17 1/8 oz.      |
| AF 100-400mm f/4.5-6.7 APO D           | 14/11               | 24°-6° 10'                          | 6.6'                                       | f/32-45                | 72mm             | 2 1/8 x 5 1/8"                | 29 1/8 oz.      |
| AF 50mm f/2.8                          | 7/6                 | 47°                                 | 0.7'                                       | f/32                   | 55mm             | 2 1/8 x 2 1/8"                | 11 1/8 oz.      |
| AF 50mm f/3.5                          | 5/5                 | 47°                                 | 0.7'                                       | f/32                   | 55mm             | 2 1/8 x 2 1/8"                | 7 oz.           |
| AF 100mm f/2.8 Macro (D)               | 8/8                 | 24°                                 | 1.2'                                       | f/32                   | 55mm             | 2 1/8 x 3 1/8"                | 18 oz.          |
| STF 135mm f/2.8 [T4.5] (2)             | 8/6                 | 18°                                 | 2.85'                                      | f/2.8(T4.5)-31(T32)    | 72mm             | 3 1/8 x 3 1/8"                | 25 1/8 oz.      |
| AF 100mm f/2.8 SOFT FOCUS              | 7/7                 | 24°                                 | 2.62'                                      | f/32                   | 55mm             | 2 1/8 x 3 1/8"                | 15 1/8 oz.      |
| AF 200mm f/4 Macro APO G               | 13/8                | 12°-30'                             | 1.64'                                      | f/4-32                 | 72mm             | 3 1/8 x 7 1/8"                | 40 1/8 oz.      |
| AF Macro Zoom 3x-1x f/1.7-2.8          | 7/5                 | 8x12mm (3x) (3)<br>24x36mm (1x) (3) | Working Distance<br>1.0" (3x)<br>1.6" (1x) | f/16 (3x)<br>f/27 (1x) | 46mm             | (4)<br>3 1/8 x 4 1/8 x 3 1/8" | 38 1/8 oz.      |
| AF 1.4x Tele Converter II APO(5)       | 5/4                 | —                                   | —  | —                      | —                | 2 1/8 x 1 1/8"                | 6 1/8 oz.       |
| AF 2x Tele Converter II APO(6)         | 6/5                 | —                                   | —  | —                      | —                | 2 1/8 x 1 1/8"                | 7 1/8 oz.       |

\*The Auto Zoom functions are not possible on AF Power Zoom 35-80mm Lens

**ORDER & INFO. (212) 502-6340 • FAX: (212) 239-7770 (800) 947-7008  
1-800-290-6750 • www.bhphotovideo.com**



**CAMERAS & LENSES**

**91**

# KONICA MINOLTA

## MAXXUM AUTOFOCUS LENS ACCESSORIES

### Hard Lens Cases



- LH-1011 (MILH1011):** For 28mm f/2.8, 50mm f/1.7, 50mm f/1.4.....**27.95**
- LH-1013 (MILH1013):** For 135mm f/2.8..**29.95**
- LH-1031 (MILH1031):** For 24mm f/2.8, 28mm f/2, 35-70mm f/4 .....**14.95**
- LH-1032 (MILH1032):** For 50mm f/2.8 Macro, 24-50mm f/4 .....**14.95**
- LH-1033 (MILH1033):** For 28-80mm.....**29.95**
- LH-1038 (MILH1038):** For 24-85mm f/3.5-4.5 and 28-105mm f/3.5-4.5 .....**29.95**
- LH-1044 (MILH1044):** For 70-210mm and 100-300mm .....**29.95**
- LH-1053 (MILH1053):** For 85mm f/1.4 and 20-35mm f/3.5-4.5 .....**33.50**
- LH-1074 (MILH1074):** Replacement for 17-35mm f/3.5 .....**41.95**
- LH-1076 (MILH1076):** Replacement for 500mm f/8 .....**49.95**
- LH-1084 (MILH1084):** Replacement for 200mm f/4 Macro APO .....**56.95**

### Soft Lens Cases

- LS-1100 (MILS1100):** For 24-85, 28-80, 28-100, 28-105 and 35-70mm .....**29.95**
- LS-1200 (MILS1200):** For 35-200, 70-210 and 100-300mm f/4.5-5.6.....**29.95**
- LS-2200 (MILS2200):** For 24-105mm.....**19.95**
- LS-2300 (MILS2300):** For 100-300mm f/3.5-4.5 and 75-300mm f/4.5-5.6.....**19.95**
- LS-2400 (MILS2400):** For 85mm f/1.4.....**24.95**



### Replacement Lens Caps

- LR-1000 Rear Lens Cap for Maxxum Auto Focus Lenses (MILCRAF) .....7.50**
- LF-1249 49mm Snap-On Lens Cap (MILC49).....9.95**
- LF-1255 55mm Snap-On Lens Cap (MILC55).....9.95**
- LF-1262 62mm Snap-On Lens Cap (MILC62).....9.95**
- LF-1272 72mm Snap-On Lens Cap (MILC72).....9.95**
- Leatherette Front Lens Cap (Cover) for 300mm f/2.8 APO (MILC300AFQ) .....49.95**

### FILTER PRICING

| Filter Type               | 49mm            | 55mm             | 62mm             | 72mm             | 77mm             |
|---------------------------|-----------------|------------------|------------------|------------------|------------------|
| A12 Color Conversion      |                 |                  | MIA1262<br>29.95 |                  |                  |
| B12 Color Conversion      |                 |                  | MIB1262<br>29.95 |                  |                  |
| 80B Color Conversion      |                 | M180B55<br>24.95 |                  | M180B72<br>44.95 |                  |
| 85 Color Conversion       | M18549<br>19.95 | M18555<br>24.95  |                  |                  |                  |
| Neutral Density           |                 | MIND455<br>23.95 | MIND462<br>29.95 | MIND72<br>43.95  |                  |
| Skylight 1B               | MISL49<br>19.95 | MISL55<br>22.95  | MISL62<br>39.95  | MISL72<br>44.95  |                  |
| UV Haze                   | MIUV49<br>9.95  | MIUV55<br>22.95  | MIUV62<br>39.95  | MIUV72<br>44.95  |                  |
| Circular Polarizer        | MICP49<br>44.95 |                  | MICP62<br>74.95  | MICP72Q<br>99.95 | MICP77<br>119.95 |
| Circular Polarizer II     |                 | MICP55<br>49.95  | MICP62<br>74.95  | MICP72<br>99.00  |                  |
| Green Glass for B&W Film  | MIGR49<br>19.95 | MIGR55<br>19.95  | MIGR62<br>29.95  |                  |                  |
| Orange Glass for B&W Film | MIO49<br>19.95  | MIO55<br>19.95   | MIO62<br>29.95   | MIO72<br>44.95   |                  |
| Red Glass for B&W Film    | MIR49<br>19.95  |                  | MIR62<br>29.95   |                  |                  |
| Yellow Glass for B&W Film |                 | MIY55<br>19.95   | MIY62<br>29.95   | MIY72<br>44.95   |                  |

- A12 Color Conversion Filter (MIA12200AF):** For 200, 300, 400 and 600mm AF APO Lenses **43.95**
- B12 Color Conversion Filter (MIB12200AF):** For 200, 300, 400 and 600mm AF APO Lenses **39.95**
- Drop-In Clear Glass Filter (MIC300AF):** For 300mm f/2.8 AF APO Lenses .....**234.95**
- Drop-In Polarizer Filter (MIP200AF):** For 300/2.8 400/4.5 and 600/4 AF APO Lenses .....**317.95**
- ND 4x Filter (MIND4200AF):** For 200, 300, 400 and 600mm AF APO Lenses .....**43.95**
- ND 4x Filter (MIND4500AF):** For 500mm Reflex Lenses .....**29.95**
- Normal Drop-In Filter (MIN200AF):** For 200, 300, 400 and 600mm AF APO Lenses .....**43.95**
- Normal Drop-In Filter (MIN500AF):** For 500mm Reflex Lenses .....**29.95**
- Normal Filter (MIN600):** For 600mm APO Lenses .....**48.95**
- Orange Filter for B&W Film (MIO200AF):** For 200, 300, 400 and 600mm AF APO Lenses....**43.95**
- Red Filter for B&W Film (MIR200AF):** For 200, 300, 400 and 600mm AF APO Lenses .....**43.95**
- Red Filter for B&W Film (MIR250):** For 250/500mm Reflex Lenses .....**42.95**
- Yellow Filter for B&W Film (MIY200AF):** For 250/500mm Reflex Lenses .....**43.95**



# KONICA MINOLTA

## MAXXUM AUTOFOCUS LENS ACCESSORIES

### Close-up Accessories

#### Copy Stand III (MICS3):

A simple, well-built and straight forward copy unit. It features a solid, geared center column while its baseboard is large enough for copying originals up to approximately 16 x 20". The center column can be reversed for copying on the floor when originals exceed the size of the baseboard. A firm camera mount is marked off in degrees for a certain degree of perspective correction although the mount, itself, is not rotatable. The unit disassembles for easy storage when not in use.....Call

#### Slide Copy Unit 1000 (MISCU1000):

A compact and efficient way to make dupes of all your favorite slides. Requirements are a Minolta camera and either the 50mm f/2.8 or 100mm f/2.8 Macro lenses or the 3X-1X f/1.7-2.8 Macro Lens in conjunction with the Macro Flash System 1200AF Set N.

Registration pins position the film over a diffuser and hold it steady during shooting. Vertical and horizontal adjustments are possible using knobs on either side of the stand .....199.95



### Close-up Lenses

Have you ever wished that your lens could focus closer than it does? Imagine that you could put a magnifying glass in front of your camera's lens. Close-up lenses work in this fashion and are the simplest and least expensive method of close-up photography. They are available in different "powers" (diopters). Minolta close-up lenses are available in strengths of #0, #1 and #2, with #2 having the greatest magnification. A #0 close-up lens will allow you to focus your lens somewhat closer than it already does. A +2 close-up lens will allow you to focus closer than the +1. These lenses can be used individually or in any combination to achieve ultra-close focus. The maximum magnification achieved with these attachments will depend on the focal length of your lens as well as the actual close focusing capability of that particular lens.

49mm #0 Close-up Lens (MICUL049).....29.95

55mm #0 Close-up Lens (MICUL055) .....29.95

49mm #1 Close-up Lens (MICUL149).....29.95

55mm #1 Close-up Lens (MICUL055) .....29.95

49mm #2 Close-up Lens (MICUL249).....29.95

55mm #2 Close-up Lens (MICUL055) .....29.95

### Konica Minolta 3-Year Extended Warranty for Maxxum Cameras (MIEWM)

This extended warranty covers an additional three years of parts and labor service from date of purchase. This limited warranty applies to all Minolta Maxxum series cameras. The equipment will be guaranteed to operate properly according to manufacturer's specifications or will be repaired to operate properly at no charge to you. This warranty does not cover equipment which has been misused, tampered with, modified or damaged as a result of accident, water, grit, impact or lack of proper care as indicated in the manual of operations. This limited warranty is non transferable. Note: This warranty can only be purchased within 30 days of original equipment purchase .....39.95

### Lens Hoods

Lens Hood (MILH100300AF): For 100-300mm f/4.5-5.6 APO (Replacement) .....19.95

Lens Hood (MILH100300AQ): For 100-300mm f/4.5-5.6 D APO (Replacement) .....18.95

Lens Hood (MILH100DAF): For 100mm f/2.8 Macro D f/4.5-5.6 D APO (Replacement) .....18.95

Lens Hood (MILH1735AF): For 17-35mm f/3.5 (Replacement) .....79.95

Lens Hood (MILH200AF): For 200mm f/4.0 Macro APO (Replacement) .....42.95

Lens Hood (MILH2035AF): For 20-35mm f/3.5-4.5 (Replacement) .....29.95

Lens Hood (MILH20AF): For 20mm f/2.8 (Replacement) .....19.95

Lens Hood (MILH24105AF): For 24-105mm f/3.5-4.5 D (Replacement) .....18.95

Lens Hood (MILH24AF): For 24mm f/2.8 (Replacement) .....19.95

Lens Hood (MILH28100AF): For 28-100mm f/3.5-5.6 (Replacement) .....18.95

Lens Hood (MILH2870AF): For 28-70mm f/2.8 (Replacement).....46.95

Lens Hood (MILH2880DAF): For 28-80mm f/3.5-5.6 D (Replacement) .....46.95

Lens Hood (MILH28AF): For 28mm f/2 (Replacement) .....19.95

Lens Hood (MILH300AF): For 300mm f/4 (Replacement) .....103.95

Lens Hood (MILH3580AF): For 35-80mm f/4-5.6 (Replacement) .....19.95

Lens Hood (MILH35AFQ): For 35mm f/2 (Replacement) .....19.95

Lens Hood (MILH35AFZ): For 35mm f/1.4G lens.....19.95

Lens Hood (MILH70210AFZ): For 70-210mm f/4.5-5.6 (Replacement) .....19.95

Lens Hood (MILH75300AFQ): For 75-300mm f/4.5-5.6 (Replacement) .....19.95

Lens Hood (MILH85DAF): For 85mm f/1.4 D (Replacement) .....29.50

CAMERAS & LENSES

93



# NIKON

## FM10



### 35mm Manual SLR Camera

Your entry into the exciting world of Nikon photography, the FM10 is a 35mm SLR designed for those who want full manual control. Film advance and rewind is manual. A center-weighted match-diode light metering system guides towards a great exposure, or you do it on your own selecting shutter speed and aperture. You focus manually and preview depth-of-field to see the image quality and sharpness.

Ideal for anyone who wants to learn the basics, or simply wants to add an additional camera, the FM10 includes a versatile 35-70mm f/3.5-4.8 Zoom Nikkor lens, Eveready case, strap and batteries. Incorporating the venerable F lens mount, it accepts AF Nikkor and AI-S Nikkor lenses as well as Nikon Speedlights and a range of other accessories.

### FEATURES

#### High Performance

- ◆ Shoot action stopping sharp pictures at up to 1/2000 sec., or achieve creative light patterns at slow speeds like 1 second
- ◆ For very long exposures, Bulb setting lets you capture beautiful night scenes and long time exposures for creative exciting photography. A tripod is required for best results.
- ◆ Shoot double exposures which can be lots of fun. With creative thought and careful preparation, will result in great pictures.
- ◆ Daylight, night-time and indoors—flash photography is easy. With a built-in ISO hot shoe the FM10 accepts virtually every Nikon speedlight ever made for manual or automatic (non-TTL) operation.
- ◆ Nikon's accurate center-weighted light meter guides you towards perfect exposures. With the built-in +/- LED display, creative adjustments are just a turn-of-a-dial away.
- ◆ 10-second self-timer lets you put yourself in the pictures.

#### Conveniences

- ◆ Make better pictures with the FM10's depth-of-field preview. Simply press a button to see the range of sharpness that will appear in your final photo. Using through-the-lens SLR viewing, and being able to see the range of sharpness is an exciting way for new photographers to visualize depth-of-field
- ◆ Compact, lightweight and comfortable to hold, the FM10 delivers roll after roll.
- ◆ Comes as a package with a 35-70mm f/3.5-4.8 Nikkor Zoom for flexible and creative range for general photography. This popular lens provides coverage for shooting beautiful wide-angle scenics to stunning telephoto portraits.
- ◆ Accepts dozens of AF & AI-S Nikkor lenses all perfectly compatible with the FM10's manual focusing operation. Light and compact, the optional 70-210 offers the most popular telephoto zoom range, perfect for action, candid, sports and portraiture.

#### FM10 Specifications:

- Lens Mount: Nikon F mount lenses
- Focus Modes: Manual
- Focus Type: Manual
- Exposure Modes: Manual
- Exposure Metering: Center-weighted
- Metering Range: EV 2-19 @ ISO 100 with f/2.0 Lens
- Shutter Speed: 1/2000th to 1 Second + Bulb, with sync at 1/125th second
- ISO Range: 25-5000 (manually set)
- Film Wind: Manual
- Focusing Screen: Fixed split image screen with microprism
- Diopter Correction: Interchangeable
- Self Timer: 10-second delay
- Remote Control: Accepts standard mechanical cable release
- Depth-of-Field Preview: Yes
- Mirror Lock-Up: Yes (using self-timer)
- Multiple Exposure: Yes
- Power Source: Two 1.5-volt LR44 alkaline batteries
- Dimensions: 5.5 x 3.4 x 2.0" WxHxD
- Weight: 0.88 lb

#### FM10 35mm Manual Focus SLR Camera Kit (NIFM103570):

Includes FM10, Nikon 35-70mm f3.5-4.8 AIS lens, fitted Nikon case, strap and two LR44 1.5v batteries .....IMP. 209.95 /USA 219.95

#### FM10 35mm Manual Focus SLR Camera Kit (NIFM102LK):

Same as above, plus the 70-210mm f/4.5-5.6 AIS lens .....IMP. 324.90 /USA 359.90

USA= Imported & Warrantied by Nikon USA

IMP. = Imported & Warrantied by B&H (not qualified for Nikon rebates and warranties)



EQUIPMENT LEASING AVAILABLE

# NIKON

## FM3A

### 35mm Manual SLR Camera

Designed for those who honor tradition—the photographic purist or the student first learning this craft. The FM3a (available in silver or black) is a manual-focus 35mm SLR camera featuring a special hybrid shutter control system enabling full mechanical exposure control range plus electronic shutter speed control. Fully mechanical operation with manual focusing puts the photographer in charge of any picture-taking situation. Add a small battery and you gain the advantage of Nikon's performance proven 60/40 TTL Center-Weighted Metering system, and unheard of in a mechanical SLR — aperture priority automatic exposure for the utmost in shooting flexibility. The FM3a also features a durable die-cast metal body; bright viewfinder and interchangeable screens for critical manual focusing; center-weighted TTL full-aperture exposure metering with exposure compensation; up to 1/4000 second shutter speed; and TTL flash control. With the optional MD-12 Motor Drive, you can shoot up to 3.2 frames per second.



#### FEATURES

- ◆ Hybrid shutter control system enables full mechanical shutter range plus electronic shutter speed range of operation. For mechanical operation, shutter control doesn't need battery power, allowing you to shoot in all types of conditions, including extremely cold weather, without having to worry about battery failure.
- ◆ Using batteries you can take advantage of the camera's built-in exposure meter. The battery power check is displayed for 16 seconds with the meter-on timer. Under battery power the FM3A offers Aperture-Priority Auto Exposure. With Aperture-Priority control, you choose the desired aperture, while the FM3A automatically sets the appropriate shutter speed.
- ◆ 60/40 center-weighted meter easily handles a wide range of lighting. Using it as your guide, you're in full control of the camera's shutter speed and aperture as you monitor each adjustment through the full-information viewfinder. Use match-needle metering with the FM3A's guidance or experiment with intentional over- or under-exposures.
- ◆ Top shutter speed of 1/4000 second allows critical action-stopping photos. Speed can be manually selected from 1/4000 to one second. In Aperture-Priority mode, shutter speed is controlled from 8 to 1/4000 second.
- ◆ Exposure compensation lets you vary exposure  $\pm 2$  EV in 1/3 EV Steps.
- ◆ Lock in exposure and recompose the shot as you like with Auto Exposure Lock (AE-L)
- ◆ Fast 1/250 sec. TTL flash sync, with fill-flash capability allows shooting in virtually all ambient light conditions. When used with Nikon TTL Speedlights, the FM3A's TTL sensor monitors both ambient and flash illumination. When the total light accumulated is right for the correct exposure, the flash automatically turns off.
- ◆ For fill effects, the FM3A includes a TTL flash compensation button which reduces flash output for a balanced fill-flash or to avoid overexposure of subjects against a dark background. Slow Sync Fill-Flash is also possible in manual exposure mode.
- ◆ Compatible with DX-coded film (ISO 25 to 5000) and ISO 12 to 6400 (manual)
- ◆ Includes a bright split image rangefinder and matte surface focusing screen (interchangeable) for critical manual focus.
- ◆ Rugged and durable with a die-cast body made of copper silumin aluminum, a metal alloy that significantly reduces the effects of extreme temperature and humidity. While remarkably light, the alloy is rigid and resistant to metal fatigue and corrosion.

#### FM3A Specifications

- Lens Mount: Nikon F mount lenses
- Focus Modes: Manual
- Exposure Modes: Aperture priority and manual
- Exposure Metering: Centerweighted
- Metering Range: EV -1 to 20 @ ISO 100 with f/1.4 Lens
- Shutter Speed: 1/4000th to 8 Seconds + Bulb, with sync at 1/250th second
- Exposure compensation:  $\pm 2$  EV in 1/3 EV increments
- ISO: 25-5000 (DX), 12-6400 (manual)
- Film Wind: Manual
- Focusing Screen: Interchangeable (includes K3 screen with split image & microprism)
- Diopter Correction: Interchangeable comes standard with -1
- Self Timer: 10-Second delay
- Remote Control: Accepts standard mechanical cable release
- PC Terminal: Yes
- Depth-of-Field Preview: Yes
- Mirror Lock-Up: Yes (when self timer is used) Multiple Exposure Yes
- Power: 3-volt DL13/N lithium battery
- Dimensions: 5.6 x 3.5 x 2.3" (WxHxD)
- Weight: 1.26 lb

**FM3A Chrome Body (NIFM3AC):** Includes eyecup and battery .....IMP. 499.95 /USA 579.95  
**FM3A Black Body (NIFM3AB):** Includes eyecup and battery .....IMP. 519.95 /USA 599.95

# NIKON

## ACCESSORIES for FM10 and FM3A

### MD-12 Motor Drive (NIMD12)

For the FM3a, the MD-12 provides single or up to 3.2 frames per second continuous frame advance. It can use lithium "AA" batteries to extend shooting capacity, decrease weight and improve low temperature performance .....IMP. 319.95 /USA 379.95

### MF-16 Data Back (NIMF16)

Lets you record the date or time directly upon the image area of the film as a permanent record.....IMP. 179.95 /USA 234.95

### Focusing Screens

There are two optional bright matte interchangeable focusing screens available for the FM3A. The B3 Matte/Fresnel is for close-up or long telephoto shooting. The E3 Grid-Line screen is for architecture and landscape, and offers pinpoint-focus, even in dim light.

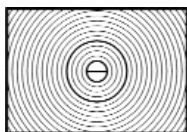

B3

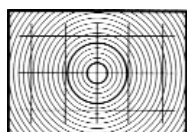

E3

**B3 Focusing Screen (NIFSB3FM3A) .....34.95**

**E3 Focusing Screen (NIFSE3FM3A) .....34.95**

### FM3A Soft Camera Cases

**CF-27 (NICF27):** For FM3A with wide-angle or 45mm f/2.8 lens.....**64.95**

**CF-27S (NICF27S):** For FM3A with standard 50mm lens.....**44.95**

**CF-27D (NICF27D):** Case base for the FM3A with MF-16 Data Back. Use with the CF-27, CF-28 and CF-28A.....**29.95**



CF-28

**CF-28 (NICF28):** For FM3A with wide-angle or short telephoto lens.....**79.95**

**CF-28A (CF28A):** An addition to the CF-27 or CF-28 cases, the

CF-28A is a front flap when using longer zoom lenses .....**39.95**

**CF-29 (NICF29):** For FM3A with MD-12 Motor Drive attached .....**94.95**

### Optional Eyepiece Accessories for the FM10

| #      | Description                             | Price |
|--------|---|-------|
| # 2370 | Eyepiece Adapter                        | 3.95  |
| # 2940 | 0 Diopter - Eyepiece correction lens    | 12.95 |
| # 2941 | +0.5 Diopter - Eyepiece correction lens | 12.95 |
| # 2942 | +1.0 Diopter - Eyepiece correction lens | 12.95 |
| # 2943 | +2.0 Diopter - Eyepiece correction lens | 12.95 |
| # 2944 | +3.0 Diopter - Eyepiece correction lens | 12.95 |
| # 2945 | -2.0 Diopter - Eyepiece correction lens | 12.95 |
| # 2946 | -3.0 Diopter - Eyepiece correction lens | 12.95 |
| # 2947 | -4.0 Diopter - Eyepiece correction lens | 12.95 |
| # 2948 | -5.0 Diopter - Eyepiece correction lens | 12.95 |

### Cable Releases for the FM3A

#### MC-12B Locking

#### Electronic Cable Release (NIMC12B)

Designed for use with the FM-3a equipped with the MD-12, the MC-12B allows remote control photography up to 2.6' away. It has a convenient handgrip, trigger release button and trigger lock lever. Depressing the button halfway turns on the camera's exposure meter. Depressing fully releases the shutter. Trigger lock enables time exposures .....**49.95**

#### AR-9 Soft Shutter Release (NIAR9)

For mounting on shutter buttons fitted with ISO-type tapered thread .....**7.50**



AR-3 Cable Release

AR-8 Cable Release

#### AR-3 Cable Release (NIAR3)

With ISO-type tapered thread for the FM3a, the AR-3 is essential for slow shutter speeds and ensures one-hand shutter release operation .....**17.50**

#### AR-8 Cable Release (NIAR8)

Adapts cable release connectors fitted with Nikon-type mount for operation with cameras having ISO-type tapered thread. For use with the AR-2/4 release only and FM3A.....**6.95**

#### DB-2 Anti-Cold Battery Pack (NIDB2)

Bring the power source outside of FM3A. The DB-2 allows you to keep the batteries in your pocket so you can shoot in extremely low temperatures. Two 1.5v "AA" batteries are required, and lithium batteries can also be used to further increase temperature resistance as well as increase battery life .....**69.95**

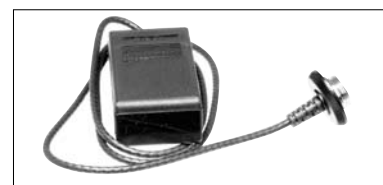

### Optional Eyepiece Accessories for the FM3A

| #      | Description                                  | Price |
|--------|--|-------|
| # 2971 | DK-13 Eyepiece Adapter                       | 11.95 |
| # 2925 | Finder Eyepiece                              | 16.95 |
| # 2362 | DK-3 Rubber Eyecup                           | 11.95 |
| # 2930 | Neutral 0 Diopter - Eyepiece correction lens | 16.95 |
| # 2931 | +0.5 Diopter - Eyepiece correction lens      | 16.95 |
| # 2932 | +1.0 Diopter - Eyepiece correction lens      | 16.95 |
| # 2933 | +2.0 Diopter - Eyepiece correction lens      | 16.95 |
| # 2934 | +3.0 Diopter - Eyepiece correction lens      | 16.95 |
| # 2935 | -2.0 Diopter - Eyepiece correction lens      | 16.95 |
| # 2936 | -3.0 Diopter - Eyepiece correction lens      | 16.95 |
| # 2937 | -4.0 Diopter - Eyepiece correction lens      | 16.95 |
| # 2938 | -5.0 Diopter - Eyepiece correction lens      | 16.95 |



For Any Inquiries Regarding Your Order, Call Our Customer Service:  
(800) 221-5743 • (212) 239-7765 • FAX: (800) 947-2215 • (212) 239-7549



# NIKON

## MANUAL FOCUS LENSES

### 20mm f/2.8 AIS Super Wide Angle Lens (NI2028)

This ultra wide angle autofocus lens allows for pinpoint focusing even in dim light. 94° Picture coverage with edge-to-edge sharpness. Tremendous depth of field enables quick shooting. Close-Range Correction for distortion-free pictures as close as 10". No light fall-off even when wide open. Accepts 62mm filters; HB-4 lens hood..... IMP. 499.95

### 24mm f/2 AIS Wide Angle Lens (NI242)

Wide 84° picture angle, extra depth of field, and a large f/2 maximum aperture make this lens ideal for many applications, but especially those that involve shooting with available light. Shoot landscapes, candid, sports or interiors. Weighs only 10.6 oz. Superb picture quality, even as close as 12", thanks to Nikon's Close-Range Correction System. Accepts 52mm filters; HK-2 lens hood ..... IMP. 589.95 /USA 799.95



### 24mm f/2 AIS Wide Angle Lens (NI2428)

Compact and lightweight, this lens offers fast and precise focusing while eliminating close-focus aberrations with a rear-focusing floating optical element. Accepts 52mm filters; HN-1 lens hood..... IMP. 359.95

### 28mm f/2 AIS Wide Angle Lens (NI282)

Considered the standard wide angle lens, the 28mm f/2 gives you a picture angle of 74°, and a fast f/2 maximum aperture for easy focusing even in dim light. Ideal for candid, cityscapes and travel photography. Sharp images at all apertures. Close-range correction system for edge-to-edge sharpness at minimum focusing distance of 11". Weighs 12.7 ounces. Accepts 52mm filters; HN-1 lens hood.....IMP. 589.95 /USA 699.95

### 28mm f/2.8 AIS Wide Angle Lens (NI2828)

A classic wide angle lens with compact size, sharpness throughout the image and Nikon's revered manual focus dampening. Accepts 52mm filters; HN-2 lens hood ..... IMP. 339.95

### 28mm f/3.5PC AIS Wide Angle Lens (NI2835PC)

This lens features Nikon "Perspective Control" technology, which is indispensable for architectural and interior photography. It offers the versatility of a view camera in a relatively compact size. 11mm off-axis shift and 360° rotation capability. 74° picture coverage. It includes a hard case, accepts 72mm filters and HN-9 lens hood .....IMP. 899.95 /USA 1259.95

### 35mm f/1.4 AIS Wide Angle Lens (NI3514)

One of the fastest Nikkor wide angle lenses, the 35mm f/1.4 provides easy pinpoint focusing, even indoors in dim light. It offers 62° of picture coverage and extra depth-of-field for spur-of-the-moment "grab shots". A close-range correction system allows sharp pictures down to 12". It accepts 52mm filters; HN-3 lens hood .....IMP. 579.95 /USA 899.95

### 35mm f/2 AIS Wide Angle Lens (NI352)

Nikon's AIS manual focus lenses feature wide, well-ribbed rubberized focusing rings with excellent dampening properties. They focus quickly and accurately and are all notably sharp. The 35mm f/2.0 is no exception and with its large maximum aperture of f/2.0 allows handheld photography in low light. It accepts 52mm filters; and the HN-3 lens hood..... IMP. 359.95

### 45mm f/2.8P AIS Compact Standard Lens

A special edition compact standard lens in a silver metallic or black finish, the 45mm f/2.8P has a simple, sharp optical formula and is very easy to focus. It features a built-in CPU for information exchange (P-type Nikkor) making it compatible with all exposure modes of CPU-controlled Nikon SLRs (P-type Nikkor) as well as the FM3A and FM10. It includes the HN-35 lens hood, a soft lens pouch and a 52mm NC filter.

45mm f/2.8P AIS Compact Standard Lens (NI4528P): Silver .....IMP. 289.95 /USA 329.95  
45mm f/2.8P AIS Compact Standard Lens (NI4528PB): Black .....IMP. 299.95 /USA 349.95



USA= Imported & Warrantied by Nikon USA

IMP. = Imported & Warrantied by B&H (not qualified for Nikon USA rebates and warranties)

ORDER & INFO. (212) 502-6340 • FAX: (212) 239-7770 (800) 947-7008  
1-800-290-6750 • www.bhphotovideo.com



# NIKON

## MANUAL FOCUS LENSES

### **50mm f/1.2 AIS Standard Lens** (NI5012)

The fastest lens available in the Nikon lineup, the 50/1.2 is only available in manual-focus AIS. Reveals new possibilities in low-light photography. Accepts 52mm filters; HS-12 lens hood.....**IMP. 429.95 /USA 549.95**

### **50mm f/1.4 AIS Standard Lens** (NI5014)

Offering versatility, wide coverage and unmatched cost performance, the 50mm f/1.4 AIS is a fast, small standard lens known for outstanding optics and the satisfying focus dampening of the Nikon AIS line of manual focus optics. Accepts 52mm filters; HR-1 lens hood.....**299.95**

### **50mm f/1.8 AIS Standard Lens** (NI5018)

Standard lenses closely duplicate the natural angle of the human eye. Very small, light and easy to focus, the 50mm f/1.8 offers outstanding cost performance for a wide range of situations. Accepts 52mm filters; HR-2 lens hood.....**119.95**

### **55mm f/2.8 AIS Macro Lens** (NI5528M)

The 55mm Micro-Nikkor is capable for both close-ups as well as normal perspective photos at infinity focus. It has a minimum focus of 10.8" and offers 1:2 life-size reproduction ratio (1:1 with optional PK-13 Extension Tube). Accepts 52mm filters; HN-3 lens hood.....**IMP. 289.95 /USA 399.95**

### **85mm f/1.4 AIS Portrait/Telephoto Lens** (NI8514)

The fastest telephoto in the Nikkor line, the 85mm f/1.4 offers beautiful selective focus at maximum aperture making it ideal for people pictures. Employs Nikon's Close-Range Correction System, ensuring high resolution down to a close focusing distance of 36". Accepts 72mm filters. Includes HN-20 lens hood.....**IMP. 699.95 /USA 969.95**

### **105mm f/2.5 AIS Short Telephoto Lens** (NI10525)

Considered the classic portrait lens with picture coverage of 23°. Relatively large maximum aperture is convenient for pinpoint focusing and shooting in available light. Focuses down to 42". 52mm filter size. Built-in lens hood.....**IMP. 339.95 /USA 409.95**

### **135mm f/2.8 AIS Telephoto Lens** (NI13528)

An excellent choice for action photography and available light shooting, the 135mm f/2.8 is very compact and light for a lens of this focal length. Stops down to f/32. Accepts 52mm filters. Has a built-in lens hood.....**IMP. 319.95 /USA 409.95**

### **180mm f/2.8ED AIS Telephoto Lens** (NI18028ED)

With extra low dispersion glass and Nikon's revered manual focus dampening, this 180mm lens is great for concert venues, sporting events and other telephoto lens requirements. Accepts 72mm filters. Has a built-in lens hood .....**749.95**

### **500mm f/8 AIS Reflex Mirror Lens** (NI5008)

An essential tool for every sports and wildlife photographer. Narrow 50° provides 10X magnification of the subject. Catadioptric (mirror) design eliminates chromatic aberration for outstanding picture quality. Focuses down to 5', and includes a CL-39 hard case, HN-27 lens hood, and five 39mm rear drop-in filters (L37C, O56, A2, B2 and NDx4).....**IMP. 769.95 /USA 869.95**

USA= Imported & Warrantied by Nikon USA

IMP. = Imported & Warrantied by B&H (not qualified for Nikon rebates, warranties)



For Any Inquiries Regarding Your Order, Call Our Customer Service:  
(800) 221-5743 • (212) 239-7765 • FAX: (800) 947-2215 • (212) 239-7549

# NIKON

## MANUAL FOCUS LENSES

### 1000mm f/11 AIS

#### Reflex Mirror Lens (NI100011)

Ideal for photographing shy or dangerous animals. Powerful frame-filling 20X magnification. Outstanding picture quality. Very compact and light for its long focal length. Catadioptric (mirror) design eliminates chromatic aberration for outstanding picture quality. Includes CL-29 hard case, tripod collar, built-in hood, and five 39mm drop-in filters (L37C, O56, A2, B2 and NDx4).....IMP. 1699.95 /USA 1999.95

### 55mm f/2.8 AIS

#### Macro Lens (NI5528M)

The 55mm Micro-Nikkor lens feature wide, well-ribbed rubberized focusing rings with excellent dampening properties. It is capable for both closeups as well as normal perspective photos at infinity focus. It has a minimum focus of 10.8" and offers 1:2 life-size reproduction ratio (1:1 with optional PK-13 Extension Tube). Accepts 52mm filters; HN-3 lens hood.....IMP. 289.95 /USA 399.95



### 85mm f/2.8D PC

#### AIS Micro Lens (NI8528M)

This lens opens up incredible macro photography realms. Greatly expanded depth of field is possible with the tilt function. Control of light direction and perspective is possible with the shift function. Like having a view camera exist in a 35mm package capable of macro magnification. Anyone shooting small objects in a still-life studio situation needs this lens. IAccepts 77mm filters; HB-22 lens hood. Includes hard case.....IMP. 1199.95 /USA 1319.95

### 200mm f/4.0 AIS

#### Micro IF Lens (NI2004M)

Internal focus keeps the length constant, which is ideal in macrophotography. The manual focus dampening that Nikon is known for is evident in this lens. True focal length of 200mm even at macro focusing distances gives extra working distance from the subject for more lighting options. Has a minimum focusing distance of 2.3' and provides 1:2 life-size magnification. Includes a tripod collar and has a built-in lens hood. Accepts 52mm filters.....IMP. 629.95 /USA 849.95

CAMERAS & LENSES

99

## MANUAL FOCUS ZOOM LENSES

### 28-85mm f/3.5-4.5 AIS Standard Zoom Lens (NI288535)

Compact and lightweight, this high performance zoom lens captures 28mm wide angle images and provides close focusing throughout the focusing range. Ideal for landscapes, full length portraits, travel and general purpose photography. Accepts 62mm filters; HK-16 lens hood ..... 489.95

### 35-70mm f/3.5-4.5 AIS Standard Zoom Lens (NI357033)

Excellent for general photography, the 35-70mm f/3.5-4.5 is a high-performance, standard zoom lens. Distortion is controlled throughout the range. Push-pull type zoom is ideal for zoom effects during shooting. Accepts 52mm filters; HN-2 lens hood .....269.95

### 35-200mm f/3.5-4.5 AIS

#### High Performance Zoom Lens (NI3520035)

A versatile wide angle-to-telephoto lens. Focus and compose quickly with one-touch focus zoom ring. Great for candid, full-length, and head-and-shoulder portraits. Focuses to 12". Accepts 62mm filters; HK-15 lens hood .....IMP. 849.95 /USA 999.95

### 70-210mm f/4.5-5.6 AIS Telephoto Zoom Lens (NI7021045)

With excellent manual focus dampening, this is a competent travel lens for portraiture and snapshots. Accepts 52mm filters; HR-1 lens hood.....IMP. 114.95 /USA 139.95



ORDER & INFO. (212) 502-6340 • FAX: (212) 239-7770 (800) 947-7008  
1-800-290-6750 • www.bhphotovideo.com



# NIKON

## N55

CAMERAS & LENSES

100

### 35mm Autofocus SLR Camera

Developed with the amateur photographers and first-time SLR users in mind, the N55 combines simple design and functionality with Nikon's proven features and exclusive technologies for superior SLR image quality and performance. Easy-to-operate, the N55 incorporates a host of intelligent features including a razor-sharp autofocus system, a wide range of exposure modes, advanced light metering systems with 3D matrix metering, and the added convenience of an automatic built-in speedlight. For the more adventurous user, the N55 also includes exposure control functions like auto exposure bracketing, exposure compensation and multiple exposure, giving budding photographers all the tools they need to fully discover their creative potential.

The N55's design enables users to effortlessly produce sophisticated photographic effects. The AUTO mode gives users point-and-shoot simplicity while producing SLR quality images. The camera features Vari-Program modes that fine-tune the camera's performance for specific scenes and subjects, and a large LCD panel with easy-to-read characters simplifies mode selection and monitoring. The built-in speedlight pops up automatically when shooting in low light conditions or photographing backlit subjects, ensuring a consistent and accurate exposure.



### FEATURES

#### 3-Area Autofocus System

3-Area Autofocus system provides versatile control of focusing in various situations. The camera automatically detects whether a subject is stationary or moving, and activates Focus Tracking with Nikon's advanced Lock-On technology to keep a fast-moving subject in continuous focus.

#### 3D Matrix Metering

Nikon's sophisticated 3D Matrix metering system ensures accurate exposures under diverse situations. To accurately determine the ideal exposure, the N55 uses three types of data — scene brightness, scene contrast and subject distance. After analyzing this data, the camera chooses the precise combination of shutter speed and aperture to achieve a balanced exposure. Also offers 5-Segment Matrix Metering and Center Partial Metering for greater manual control in specific situations.

#### Photos Made Easy

- ◆ Five Vari-Program modes are tailored to specific scenes and subjects; such as portrait, landscape, close-up, sports continuous, and night portrait.
- ◆ Selection of exposure modes including Auto-Multi Program, Shutter-and Aperture-priority Auto, and manual deliver precise exposure control to expand potential
- ◆ Exposure Compensation ( $\pm 2$  EV in 1/2 EV steps) and Auto Exposure Bracketing (3 frames in 1/2 EV steps) are extremely helpful when shooting under complicated lighting situations, or when experimenting with different exposure settings.
- ◆ F-Lens mount makes it compatible with over 40 superior AF Nikkor lenses. Accepts AF Nikkor and Ai-P Nikkor lenses (except AF Nikkor for F3AF and IX-Nikkor).

#### Flash System

- ◆ Flash system includes Matrix Balanced Fill-Flash to fill-in or eliminate shadows in bright-light situations and automatically balance foreground and background illuminations for stunning results.
- ◆ Built-in speedlight with 28mm wide angle coverage works seamlessly with the camera's exposure control and metering system. The speedlight pops up automatically in low light and is especially useful when shooting backlit subjects. Features include Slow Sync, Red-Eye Reduction, and Red-Eye Reduction with Slow Sync.

#### Conveniences

- ◆ Large easy-to-read LCD panel displays all settings including f-stop, shutter speed and flash mode.
- ◆ Built-in diopter adjustment (-1.5 to +0.8), multiple exposure control and AF Assist Illuminator for low light shooting.
- ◆ Nikon's smallest and lightest 35mm SLR provides superior performance in a classic design. It's comfortable, contoured design fits easily in your hands with buttons and dials conveniently placed to facilitate use.

#### N55 Camera Kit (NIN552880K):

With Nikon 28-80mm f/3.3-5.6 G-AF Lens. Kit includes a strap, front and rear lens caps, an eyecup, a hot-shoe cover and two CR2 3v lithium batteries .....**199.95**



[www.bhphotovideo.com](http://www.bhphotovideo.com)

# NIKON

## N75

### 35mm Autofocus SLR Camera

Designed for budding photographers who enjoy taking great pictures and want to advance their creative potential, the N75 offers an ideal combination of automation, usability and personal control to create photographs of breathtaking clarity and color. Integrating sophisticated technology with Nikon's intuitive design and proven features, the N75 empower photographers to create pictures with stunning color and exceptional sharpness, while offering them a choice of simplicity and ease-of-use, or full personal control.

Intelligent features including an easy-to-access 3-Mode Focus Area Selector switch, 25-segment Matrix metering system, 12 custom functions, 3D Multi-Sensor Balanced Fill-Flash and three cleverly engineered Dynamic Autofocus modes that ensure crisp, sharp pictures. At the same time, its simplified features such as the Vari-Program scene modes enable users to take brilliant pictures in everyday situations without any complexity.



CAMERAS & LENSES

101

### — Step-up Features from the N55 —

#### 3-Mode Dynamic AF System

- ◆ The camera allows easy framing by placing the 3-mode Focus Area Selector switch conveniently next to the right-hand thumb so that even while taking pictures, photographers can adjust focus area selection.
- In “Closest Subject Priority” mode, N75 automatically focuses on the subject closest to the camera. This is ideal for scenes where the subject is far from the background and you want to be certain that the “closest subject” will be in sharp focus, avoiding accidental focusing on the background.
- Similarly, in “Center Subject Priority” mode, the N75 sets focus for the subject in the center of the frame, ignoring objects or people that might be in the periphery and not the main subject of the picture.
- You can also choose to manually control the focus area selection, giving you all the latitude needed to creatively frame a shot.
- ◆ Innovative AF system features five separate AF detection sensors that cover the top, bottom, center, left, and right of the frame for fluid and accurate composition and coverage. In-focus confirmation beep notifies you when subject is in focus.

#### 25-Segment 3D Matrix Metering

- ◆ In addition to measuring the brightness and contrast of a particular scene, Nikon's exclusive 25-segment 3D Matrix meter also analyzes complex exposure and lighting conditions, comparing it with an on-board database of picture-taking information that is built on 30,000 actual scenes stored in the camera. The result is an incredibly versatile and accurate exposure control system.

#### Flash System

- ◆ Built-in speedlight (with 28mm wide angle coverage) with 3D Multi-Sensor Balanced Fill-Flash automatically pops up to fire in low-light or backlit conditions in AUTO and Vari-Program modes.
- ◆ The N75's advanced 3D Multi-Sensor Balanced fill-flash capability provides just the right amount of light to brighten shadows, add highlights, and make a shot look natural and beautifully enhanced.

#### Conveniences

- ◆ Comfortable (13.5 oz.), contoured design fits easily in your hands with buttons and dials conveniently placed to facilitate use.
- ◆ Self-Timer, remote control capability and 12 custom settings
- ◆ Battery/Film indicators in the viewfinder show battery power and film status.

**N75 Camera Body (Silver and Black) (NIN75):**  
Includes a slip-on body cap, DK-5 Eyepiece shield,  
DK-10 Eyecup and a 1-year warranty .....179.95

**N75 QD Camera Body (Black) (NIN75D):**  
Includes a slip-on body cap, DK-5 Eyepiece shield,  
DK-10 Eyecup and a 1-year warranty .....199.95



ORDER & INFO. (212) 502-6340 • FAX: (212) 239-7770 (800) 947-7008  
1-800-290-6750 • [www.bhphotovideo.com](http://www.bhphotovideo.com)



# NIKON

## N55/N75 ACCESSORIES

**MB-18 AA Battery Pack for N75 (NIMB18):**  
The MB-18 converts the N75 to the more available "AA" battery power, and in addition to standard alkaline batteries, lithium batteries can also be used to extend battery life, lower weight and improve low temperature performance .....**44.95**

**MS-18 Replacement Battery Holder (NIMS18):**  
For the MB-18.....**9.95**

**CF-62 Semi Soft Case (NICF62):**  
For N55 with 28-80mm lens.....**39.95**

**CF-63 Semi Soft Case (NICF63):**  
For N75 with 28-80mm Lens.....**39.95**

**Accessory Kit for N55 and N75 (NIAKSLR):** Includes two CR-2 Batteries, NS-1 strap, 2-year extended warranty, roll of film..... **24.95**

**Nikon 2-Year Extended Warranty for N55/N75 (NIEWN80):** Provides additional two years of parts and labor service from date of purchase..... **24.95**



### Optional Eyepiece Accessories for the N55/N75

|  |   |
|--|---|
| <b>Eyepiece Adapter (NIEPAN6006)</b> ..... <b>3.95</b> | <b>+3.0 Diopter (NIDP3N80)</b> ..... <b>12.95</b> |
| <b>0 Diopter (NID0N80)</b> ..... <b>12.95</b>          | <b>-2.0 Diopter (NIDM2N80)</b> ..... <b>12.95</b> |
| <b>+0.5 Diopter (NIDP.5N80)</b> ..... <b>12.95</b>     | <b>-3.0 Diopter (NIDM3N80)</b> ..... <b>12.95</b> |
| <b>+1.0 Diopter (NIDP1N80)</b> ..... <b>12.95</b>      | <b>-4.0 Diopter (NIDM4N80)</b> ..... <b>12.95</b> |
| <b>+2.0 Diopter (NIDP2N80)</b> ..... <b>12.95</b>      | <b>-5.0 Diopter (NIDM5N80)</b> ..... <b>12.95</b> |

### N55 Specifications

- Type of camera: Integral motor autofocus 35mm SLR with electronically controlled focal-plane shutter and built-in Speedlight
- Exposure Modes: AUTO mode, Vari-Program - Portrait, Landscape, Close-Up, Sports Continuous and Night Portrait modes, Auto-Multi Program and Flexible Program (P), Shutter-Priority (S), Aperture-Priority (A) and Manual (M) Modes
- Focusing Screen: B-Type Clear Matte V with focus brackets
- Lens Servo: In Auto Servo AF automatically chooses Single Servo AF or Continuous Servo AF operation according to subject status, i.e. stationary or moving (including directional information)
- Focus Area: One of three focus areas can be selected
- TTL full-aperture exposure metering systems:
  - 3-D five-segment evaluative with G & D AF Nikkor lenses
  - 5-segment matrix metering with AF Nikkor except G or D-type lenses
  - Center-weighted metering in manual exposure mode
- Exposure Compensation:  $\pm 2$  EV range, in 1/2 EV steps
- Auto Exposure Bracketing:  $\pm 2$  EV in 1/2 stop increments
- Multiple Exposure: Selectable in P,S,A,M
- Shutter Speeds: 30 to 1/2000 sec
- Built-in Speedlight: - Automatically activated (AUTO and Vari-Program modes), or by pressing flash-lock release button. GN is 12/39 (at ISO 100 ft), 28mm flash coverage, ISO 25-800 film speed range
- Flash Control:
  - Matrix Balanced Fill-Flash: built-in Speedlight or optional Speedlight
  - Standard TTL: in Manual exposure mode
  - Programmed Flash (Non-TTL Auto Flash) with optional Speedlight and CPU Nikkor lens (except in A or M exposure modes)
- Flash Sync Mode: Front-Curtain Sync (normal sync), Slow Sync, Red-Eye Reduction, Red-Eye Reduction with Slow Sync, Flash Cancel
- Film Speed Setting: Automatically set to ISO film speed of DX coded film in use (ISO 25-5000), in manual not selectable. Automatically set to ISO 100 with non-DX coded film.
- Accessory Shoe: standard ISO-type hot shoe contact with safety lock
- Self Timer: Electronically controlled; timer duration 10 seconds
- Film Advance: - Automatic advance with built-in motor up to 1.5 fps
- Film Rewind: - Automatic rewind in 20 seconds with 36 exposure film
- Power Source: Two 3v CR2 lithium batteries
- Measures 5.1 x 3.6 x 2.7", weighs 12.7 oz.

### N75 Specifications (same as N55 except):

- Focus Area: One of five focus areas can be selected
- Battery/no film remaining frame visible through the viewfinder
- Three TTL full-aperture exposure metering systems:
  - 3-D 25-segment matrix metering: with G or D-type AF Nikkor lenses
  - Spot metering selectable in auto-exposure lock
  - Center-weighted metering in manual exposure mode
- Exposure Compensation:  $\pm 3$  EV range, in 1/2 EV steps
- Flash Control:
  - 5-segment TTL 3D Multi-Sensor Balanced Fill-Flash
  - Standard TTL: in Manual exposure mode
  - Multi-sensor balanced fill-flash compatible with optional Speedlights and CPU Nikkor lens
- Measures 5.2 x 3.6 x 2.7", weighs 13.6 oz.

# NIKON

## N80

### 35mm SLR Autofocus Camera

For photographers, nothing matches the excitement of creating a great picture—one that combines your imagination with the moment to render an entirely new image. With the N80 in your hands, you can translate your passion into photographs that you'll be proud to call your own. The N80 is an outstanding single lens reflex camera that makes it possible for you to realize your creative photographic potential. In short, the N80 is an SLR that inspires confidence. Designed to build on the benefits of decades of field-proven Nikon expertise, the N80 offers the features you want—including fast, razor-sharp autofocus, a selection of exposure control modes, and a superb built-in Speedlight.

All of which gives you complete control over photography that you demand. Take advantage of the camera's advanced exposure and flash system, as you explore the complexities of light and shade. Use Nikon's unparalleled 5-Area AF system for optimum flexibility and control. Choose from a vast Nikon system of lenses and accessories. The possibilities are endless.



CAMERAS & LENSES

103

#### FEATURES

##### 5-Area AF System

- ◆ The N80 features five AF sensors, including a cross-type sensor, positioned in the center, and four additional line sensors positioned left, right, top and bottom of the viewfinder frame.
- ◆ This array of AF sensors covers a wide area in both the horizontal and the vertical ranges. And thanks to the placement of top and bottom sensors, the camera offers a cross-array of AF sensing even when you shoot vertical compositions.

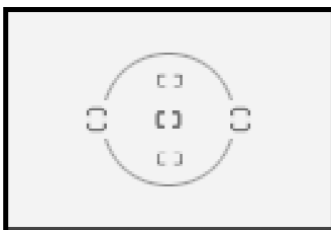

- ◆ Easy system to use, you simply press the focus area selector in the direction you want to move the AF sensor, and that area will then be superimposed in the viewfinder. Since the system lets you select the primary AF sensor before the camera is even at eye level, you can effectively anticipate the action and be ready as you bring the N80 to eye level.

##### Three AF Area Modes

- ◆ Dynamic AF mode ensures accurate focusing, even if your subject moves from its original position after you've selected a focus area. In this mode, the focus area will automatically shift from your selected focus area to the one in which the subject has moved. This makes it ideal for shooting action photos and others with unpredictable moving subjects.
- ◆ In Closest-subject-priority Dynamic AF mode, the camera automatically selects the focus area with the closest subject, so you can concentrate on shutter timing and shoot at will. This mode is ideal for candid photography.
- ◆ Single Area AF mode lets you choose a specific section of the frame (one of the five focus areas) and designate it as the primary area for focusing. This mode is ideal for shooting portraits, landscapes and other stationary subjects.

##### Focus Tracking with Lock-On

Thanks to Nikon's unique overlap Servo method, the N80's Focus Tracking enables you to focus continuously on a moving subject. Furthermore, thanks to Lock-On AF, the N80 will continue to track your main subject during Focus Tracking even if something momentarily blocks it in the viewfinder, or it moves off of an AF sensor. This feature is ideal for sports or nature photography where action is often swift and unpredictable.

##### Focusing Conveniences

- ◆ The N80 incorporates a convenient Vari-Brite Focus Area display system. Once you've selected a focus area, it is automatically superimposed in black in the viewfinder, and momentarily illuminated in red when you focus on a dark colored or poorly lit subject.
- ◆ When ambient light is insufficient for autofocusing, the AF-Assist Illuminator automatically lights up the subject. This feature works in AF-S mode when the center focus area is selected or Closest-subject-priority Dynamic AF mode is activated. It allows you to take sharply focused pictures—even in total darkness.
- ◆ Activated via Custom Setting #4, On-Demand Grid Lines suggest the best position choices for pleasing composition as well as help you keep your horizon line straight. Superimposing a grid over the viewfinder, these horizontal and vertical lines are also helpful for shooting architectural photography or landscapes that include horizons.

ORDER & INFO. (212) 502-6340 • FAX: (212) 239-7770 (800) 947-7008  
1-800-290-6750 • [www.bhphotovideo.com](http://www.bhphotovideo.com)



# NIKON

## N80

### THREE METERING SYSTEMS

#### **10-segment 3D Matrix Metering**

10-segment 3D Matrix Metering provides intelligent image analysis. In addition to reading brightness, the system analyzes the 'atmosphere' of a scene by taking the entire image into account. It achieves this by comparing the exposure information of the more than 35,000 scenes in the camera's database with a complex array of actual scene conditions, including brightness, contrast, subject-to-camera distance and the selected focus area. Use of a database distinguishes this meter from typical multi-segment meters.

#### **Center-Weighted Metering**

The meter concentrates 75% of its sensitivity on the 8mm-diameter circle while feathering the rest out to the edges, resulting in excellent overall balance. Ideal for shooting portraits or other center-dominant subjects.

#### **Spot Metering**

Gives you true pinpoint precision. Select this and the sensing area adjusts to correspond to the focus area you select manually. Ideal when individual control is critical.

### **Additional Features**

- ◆ When using Continuous Servo AF mode with film advance mode, the N80 delivers a film advance speed of 2.5 fps.
- ◆ Electronic depth-of-field preview button lets you confirm the zone of sharpest focus (in all exposure modes) before shooting.
- ◆ Built-in diopter adjustment enables near- or far-sighted photographers to adjust the eyepiece diopter from -1.8 to 0.8 DP.
- ◆ Easy-to-view LCD panel gives you at-a-glance access to vital information. It can be illuminated for viewing in dim lighting.
- ◆ 18 Custom Settings allow you to change the camera's default settings and create your own combination of settings.
- ◆ Powered by two lithium batteries, use the optional MB-16 Battery Pack (accepts 4 AA-type alkaline, lithium, Nicad or NiMH batteries) for extended power performance.

### **Four Exposure Modes—P, S, A, M**

- ◆ Auto-Multi Program mode (P) works with each of the N80's built-in light meters, including 3D Matrix Metering to provide the quickest and simplest exposure control option. Flexible Program lets you shift the combination of aperture and shutter speed set by P mode.
- ◆ Use Shutter-Priority (S) mode when you want to stop action in its tracks or blur movement for creative effect. This mode allows you to select shutter speeds between 30 seconds and 1/4000 of a second. After selecting your desired shutter speed, the N80 automatically selects the correct aperture.
- ◆ Aperture-Priority (A) mode is ideal when you want to explore the uses of depth-of-field. After selecting the aperture you want, the N80 automatically selects the correct shutter speed for you.
- ◆ Manual (M) exposure mode gives you total exposure control. You choose both the shutter speed and aperture. The electronic analog display in the viewfinder and the top-deck LCD show you the degree of exposure deviation from the metered value.

### **Exposure Compensation and Auto Exposure Bracketing**

- ◆ To experiment with varying degrees of brightness for an image, you can take pictures of the same scene with different EV values. Using the exposure compensation button, for example, you compensate the exposure within a range of  $\pm 3$  in 1/2 EV increments. Or you can perform exposure bracketing of two or three frames in 0.5 to 2.0 EV steps with all exposure modes including Manual.
- ◆ **AE-L (Auto Exposure Lock):** Press the AE-L button and the N80 memorizes the metered exposure value. Use this feature when you want to change the composition or emphasize a specific part of the picture with center-weighted or spot metering in any automatic exposure mode.
- ◆ **Multiple Exposure:** Set the film advance to multiple exposure to take as many images as you like on the same frame. When shooting in daylight, some degree of exposure compensation will be necessary.

### **Built-in Speedlight and Advanced Flash Modes**

The N80's built-in flash offers coverage for lenses as wide as 28mm and boasts a GN of 39 (ISO 100, ft.) Features include Slow Sync, Rear-Curtain Sync, Red-Eye Reduction and flash output level compensation.

#### **3D Multi-Sensor**

##### **Balanced Fill-Flash System**

The 3D Multi-Sensor Balanced Fill-Flash System analyzes scene brightness, contrast and subject reflectance to determine precisely the amount of flash needed to create a well-balanced picture—an instant before you take the picture. This is achieved by the camera's 5-segment TTL Multi Sensor and monitor pre-flash function.

##### **Flash Output Level Compensation**

You can compensate the flash output level -3 to +1EV in 1/2 steps. This lets you control the intensity of the flash to create even more exciting fill-flash photographs.

#### **Slow Sync**

Slow Sync flash mode extends the automatically controlled shutter speed range in P and A exposure modes. Use this feature to bring out the background details when shooting in low-light situations, or with an illuminated background.

#### **Rear-Curtain Sync**

With this function, the flash fires just before the second (or rear) curtain of the shutter begins to move, unlike normal sync which fires the flash at the beginning of the exposure. This creates a stream-of-light effect that follows the flash-illuminated subject.





# NIKON

## N80



CAMERAS & LENSES

105

**MB-16 AA Battery Pack for N80 (NIMB16):** Provides an improved grip that makes shooting vertical-format pictures much more comfortable, and converts the power source to four AA batteries. Quick-change battery clip easily slides in and out for fast change and accommodates alkaline, lithium or Ni-MH batteries .....**69.95**

**MS-16 Battery Holder (NIMS16):** Replacement. For the MB-16 .....**12.95**

**Accessory Kit for N80 (NIAKN80):** Includes NS-1 wide fabric logo neck strap, two 123A 3v lithium batteries, roll of film, 2- year extended warranty.....**24.95**

**Nikon 2-Year Extended Warranty for N80 (NIEWN80):** Provides additional two years of parts and labor service from date of purchase .....**24.95**

**CF-59 Semi Soft Case (NICF59):** For N80 and N80 QD with normal lens.....**39.95**

**CF60 Semi Soft Case (NICF60):** For N80 and N80 QD with short telephoto lenses .....**44.95**

**N80 Body (NIN80):** Includes DK-5 Eyepiece shield and DK-10 Eyecup .....**339.95**  
**N80 QD Body (NIN80D):** 35mm SLR Autofocus Camera Body with Date.....**369.95**  
The N80 requires two 123A 3v Lithium Batteries (GB123A) .....**3.99 ea.**

### Optional Eyepiece Accessories for the N80

|  |   |
|--|---|
| <b>Eyepiece Adapter (NIEPAN6006)</b> ..... <b>3.95</b> | <b>+1.0 Diopter (NIDP1N80)</b> ..... <b>12.95</b> |
| <b>DK-2 Rubber Eyecup (NIDK2)</b> ..... <b>9.95</b>    | <b>+2.0 Diopter (NIDP2N80)</b> ..... <b>12.95</b> |
| <b>DK-4 Rubber Eyecup (NIDK4)</b> ..... <b>9.95</b>    | <b>+3.0 Diopter (NIDP3N80)</b> ..... <b>12.95</b> |
| <b>DK-5 Eyepiece Shield (NIDK5)</b> ..... <b>1.95</b>  | <b>-2.0 Diopter (NIDM2N80)</b> ..... <b>12.95</b> |
| <b>DK-10 Rubber Eyecup (NIDK10)</b> ..... <b>3.85</b>  | <b>-3.0 Diopter (NIDM3N80)</b> ..... <b>12.95</b> |
| <b>0 Diopter (NID0N80)</b> ..... <b>12.95</b>          | <b>-4.0 Diopter (NIDM4N80)</b> ..... <b>12.95</b> |
| <b>+0.5 Diopter (NIDP.5N80)</b> ..... <b>12.95</b>     | <b>-5.0 Diopter (NIDM5N80)</b> ..... <b>12.95</b> |



**N80 Instructional Video Tape (NIVTN80):** "Getting the Most from Your Nikon N80" will help you master this camera's features, as you improve your knowledge of photography overall. National Geographic Traveler's photographer, Bob Krist explains the capabilities of this camera in a simple and understandable manner in Santa Fe, New Mexico .....**24.95**

### N80 Specifications

- Exposure modes: Programmed Auto (Flexible Program possible); Shutter-Priority Auto; Aperture-Priority Auto; Manual
- Diopter adjustment: -1.8 to +0.8 DP
- Viewfinder eyepoint: 15.5 to 20mm
- Focusing screen: Nikon Advanced Focusing Screen with Vari-Brite focus area and On-Demand Grid Lines
- Lens Servo: Single Servo AF (S), Continuous Servo AF (C), Manual focus (M) - Focus Tracking automatically status activated
- Focus area: One of five focus areas can be selected
- AF Area mode: Single Area AF and Dynamic AF (Dynamic AF Mode with Closest Subject Priority also available)
- Focus lock: Focus is locked by pressing AF-L/AE-L button or lightly pressing shutter release button in Single Servo AF
- Metering system: 10 segment 3D Matrix Metering, 75/25 Center-Weighted Metering & Spot Metering
- Exposure compensation: ±3 EV range, in 1/2 steps
- Auto exposure lock: Detected exposure value locked by pressing AF-L/AE-L button
- Auto bracketing exposure: Two or three frames, 1/2 steps
- Film speed setting: ISO 25-5000 (DX), or 6-6400 in 1/3 steps (manual)
- Shutter speeds: 30 seconds to 1/4000 of second, plus Bulb
- Additional controls: 18 user programmable Custom Settings
- Sync contact: X-contact only; flash synchronization up to 1/125 sec.
- Built-in TTL Speedlight: GN39 (ISO 100, ft) 28mm flash coverage: Red-Eye Reduction, TTL flash control including 3D Multi-Sensor Balanced Fill-Flash, Slow Sync and Rear-Curtain Sync are possible
- Flash control: 5-segment TTL Multi Sensor w/ 3D Multi-Sensor Balanced Fill-Flash with built-in and external Speedlights
- Flash sync mode : Front-Curtain Sync, Red-Eye Reduction, Red-Eye Reduction with Slow Sync, Slow Sync, Rear-Curtain Sync
- Accessory shoe: Standard ISO-type hot-shoe
- Self-timer: 2 to 20 seconds with Custom Setting
- Depth-of-field preview button: Yes
- Film advance: Automatic advance with built-in motor; S (Single) or C (Continuous) mode up to 2.5 fps
- Film rewind: 15-sec. for 36-exp., 23-sec. in quiet rewind mode
- Multiple exposure: Activated using film advance mode dial
- Power source: Two CR123A batteries
- Measures 5.6 x 3.9 x 2.8" (W x H x D), weighs 18.2 oz.

**ORDER & INFO. (212) 502-6340 • FAX: (212) 239-7770 (800) 947-7008  
1-800-290-6750 • www.bhphotovideo.com**



# NIKON

## F100

### 35mm SLR Autofocus Camera

For generations, Nikon cameras have allowed professional photographers to achieve maximum performance day-in and day-out. Performance they can count on, shot after shot. Designed to provide professional photographers with everything they need — in the studio and on assignment—the compact and rugged F100 delivers. It makes precise, responsive Dynamic Autofocus so fast, that images literally snap into focus. It also works perfectly with every AF Nikkor lens, AF-S Nikkor, AI-S Nikkor and more.

It features Nikon's 3D Matrix Metering while Nikon's automatic balanced fill-flash system is uncanny at showing up that touch of extra light for perfect exposures and cover page pictures. For extra dependability, the chassis, top, bottom and front covers, and selected parts are constructed of rugged yet lightweight magnesium alloy metal. Last, 22 custom settings and a host of accessories make the F100 a clear choice in 35mm systems.



The heart of the F100's AF system is the Multi-CAM AF module. Creatively aligned Wide-Cross Array Sensor design makes autofocus operation fast, whether you hold the camera horizontally or vertically. For creative composition, especially for action photography, you can choose any of the F100's AF sensors as a primary sensor; so you're never locked into using just the center sensor for a first AF reading.

#### Three Metering Systems

##### 10-segment 3D Matrix Metering:

10-segment 3D Matrix Metering provides intelligent image analysis. In addition to reading brightness, the system analyzes the 'atmosphere' of a scene by taking the entire image into account. It achieves this by comparing the exposure information of the more than 35,000 scenes in the camera's database with a complex array of actual scene conditions, including brightness, contrast, subject-to-camera distance and the selected focus area. Use of a database distinguishes this meter from typical multi-segment meters.

##### Center-Weighted Metering:

The meter concentrates 75% of its sensitivity on the 12mm-diameter circle while feathering the rest out to the edges, resulting in excellent overall balance. Ideal for shooting portraits or other center-dominant subjects.

##### Spot Metering:

When you need pinpoint precision, Spot Metering reads a 4mm-diameter area (1% of the image area). The sensing area also adjusts to correspond to the manually selected focus area for optimal individual control.

#### Dynamic Autofocus

Nikon's exclusive Dynamic Autofocus gives you the ability to capture the key moments, the exciting action shots that make the image special. Dynamic AF automatically follows moving objects as they cross the frame and move along five strategically placed focus areas. Should your subject move off the selected area, accurate autofocus is ensured by Nikon's Lock-On feature.

- ◆ Nikon's AF system simultaneously detects focus and drives the lens. The result is extremely precise focusing that operates smoothly and quickly frame after frame, for every frame.
- ◆ Focus tracking is automatically activated when your subject starts to move, regardless of direction, and it operates at framing rates up to 4.5 fps (frames per second). Using the optional MB-15 Multi-Power High-Speed Battery Pack, the F100 achieves speeds up to 5 fps. If the main subject wanders off the AF sensor area during focus tracking operation, or if something momentarily blocks the sensor's view, Lock-On is automatically activated and the F100 continues to track the subject, maintaining sharp focus.
- ◆ The F100 comes standard with Nikon's B-type BriteView screen. You can also choose the optional E-type screen, which also functions with the F100's built-in red LED projected display that highlights the focus detection areas.
- ◆ For maximum versatility, the F100 offers two AF modes. Single Servo AF with focus priority (AF-S) won't release the shutter until complete, sharp focus is achieved. Continuous Servo AF with release priority (AF-C) lets you release the shutter whenever you're ready. Simply press the Focus Area Selector Pad to quickly select or change a focus area.
- ◆ Manual focusing the F100 is a smooth, precise operation. It uses no battery power, so it's ideal for extending battery life in power-draining conditions. The F100's versatile electronic rangefinder simplifies manual focusing when used with lenses having a maximum aperture of  $f/5.6$  or faster—all of Nikon's AF Nikkor lenses.



### Four Exposure Modes

- ◆ Program Auto Exposure mode works with the 3D Matrix Metering to provide the quickest, simplest, most-advanced exposure control. Flexible Program automatically changes shutter speed and aperture combinations. When you don't have time to make decisions about exposure, Programmed Auto Exposure takes over.
- ◆ Aperture-Priority mode is ideal when you want to explore the uses of depth-of-field. For shooting portraits or other scenes where you want a shallow depth-of-field, try larger apertures. For more depth sharpness, as in scenic photography, use smaller apertures.



- ◆ Use Shutter-Priority mode when you want to select shutter speeds manually in 1/3 EV steps—great for stopping action in its tracks or blurring movement for creative effect. The F100 automatically selects the correct aperture in 1/3 EV increments to match the selected shutter speed. You can also customize exposure settings in 1/3, 1/2 or 1 EV steps.



- ◆ Manual mode provides complete control over exposure. Choose both the shutter speed and aperture using the F100's built-in meters as guides for optimal exposure. The electronic analog exposure display appears in the viewfinder and top deck LCD panel. This shows the exposure deviation from the metered value.

### Total Exposure Control

#### Exposure Compensation

To experiment with varying degrees of brightness for an image, you can compensate exposure up to  $\pm 5$  EV in 1/3 EV increments. Or you can perform exposure bracketing of two or three frames in 1/3 to 1 EV steps with all exposure modes including Manual. You can select bracketing with over-exposure or under-exposure only, too. For flash photography, the flash output level also varies. Custom Setting allows bracketing for either background exposure or flash exposure for flash photography.

#### Multiple Exposure

Set the film advance to multiple exposure to take several exposures on the same frame while the F100 automatically compensates for the density of the image. Explore your creative options by taking as many shots on a frame as you like. (Custom settings enable continuous multiple exposures).

#### AE-L

#### (Auto Exposure Lock)

The F100 can memorize the metered exposure value with focus lock. Use AE-L when you want to change the composition or emphasize a specific part of the picture with center-weighted or spot metering in any automatic exposure mode. Can also be used without activating focus lock (using custom settings).

#### All-Mode Depth-of-field Preview

When using an AF Nikkor or AI-type Nikkor lens, the viewfinder image is set to maximum aperture. Pressing the depth-of-field preview button stops the lens down electrically to the aperture set in any exposure mode. This lets you examine the zone of sharpest focus before shooting. Custom Settings allow changes of  $\pm 1/2$  or 1 EV steps.

### Multiple Power Sources

- ◆ The F100 is powered by 4 AA-type alkaline or lithium batteries. The optional MS-13 Battery Holder allows the camera to operate with two CR-123A lithium batteries, while the MS-12 holds 2 AA batteries. The optional MB-15 Power Pack accepts 6AA alkaline or lithium batteries as well as the MN-15 NiMH Battery Unit.

### Intuitive Operation

- ◆ The F100 has two Command Dials and a focus area selector to give you access to most features. Lock selected controls to prevent inadvertent switching. All controls are easy to operate and logically positioned for fast, easy operation.
- ◆ 22 Custom Settings enables you to choose among customized combinations of various functions/modes and two Command Dials provide access to more versatile functions. Settings allow you bypass the F100's defaults and create your own combination of settings. Change bracketing order, Command Dial functions, AE-L/AF-L button function, self-timer duration and more.

### Rugged Construction

- ◆ The F100's front body and top and bottom covers are made of rugged, armor-like magnesium alloy that provides the rigidity and strength needed to maintain precise alignment. Critical surface areas are covered with tough rubber surfaces textured to provide a secure grip and buffer against impact and harsh environments.
- ◆ Durable shutter (passed Nikon's 100,000 cycle test) and strategically placed O-rings guard against moisture and dust.
- ◆ Quick-return mirror is specially designed to help reduce mirror bounce and vibration. Coreless motors and gears are configured in a floating-type design for quiet operation. With rubber-armored, shock-absorbing construction, these motors work to minimize internal vibration.

# NIKON

## F100



Main-Command Dial



Sub-Command Dial



AE-L/AF-L Button



AF Start Button



Sync Terminal



Diopter Adjustment



AF Area Mode Selector

**Main-Command Dial:** Use this to select the shutter speed when using Shutter-Priority or Manual, or to access Flexible Program and a range of other camera settings.

**Sub-Command Dial:** Allows you to select aperture with Aperture-Priority or Manual. Custom Setting #12 let you switch the functions of the two Command Dials.

**AE-L/AF-L Button:** Simultaneously locks both exposure and focus. Use Custom Setting #21 when you want to lock exposure or focus only.

**AF Start Button:** You can activate AF operation by pressing this button or the shutter release button. This button works full time, so there's no need to use a Custom Setting to activate it.

**Sync Terminal:** Accepts all standard PC-type plug-in flash sync cords.

**Diopter Adjustment:** Enables near- or farsighted photographers to adjust the eyepiece diopter from -3 to +1.

**AF Area Mode Selector:** Lets you choose Dynamic AF or Single Area AF mode.

### Intelligent Flash System

Nikon's Automatic Balanced Fill-Flash system works perfectly with Dynamic AF and 3D Matrix Metering in terms of importance. In fact, Nikon's Fill-Flash system works perfectly with all F100 exposure modes, exposure compensation techniques, and exposure bracketing as well. It works realtime under demanding conditions for action photography, in super-bright light and dim light of dawn and dusk.

- ◆ 3D Multi-Sensor Balanced Fill-Flash works with the camera's meters, and each of the exposure control modes. With a 5-segment TTL multi-sensor, the F100 delivers sophisticated exposure control under any conditions. It precisely monitors flash output using a segmentation pattern that conforms to the classic rules of composition. The five segments enable optimum exposure control, even after the composition has changed and the subject is no longer at the original focus sensor point. Nikon's 5-segment sensor covers the entire frame, providing better flash exposure for a wider range of compositions.
- ◆ For flash photos at slower shutter speeds, Slow Sync balances the exposure of background and foreground subjects. Slow Sync extends the automatic shutter speed to the full range of available shutter speeds from 1/250 to 30 seconds.
- ◆ The F100 offers a top TTL flash sync speed of 1/250 second for automatic balanced fill-flash even with the fastest moving subjects—and sharp images with longer lenses. A wider choice of apertures offers more creative control, and lets you shoot over a wider range of ambient light conditions.
- ◆ Rear-Curtain Sync produces a stream of ambient light behind the flash illuminated subject—especially effective when slow shutter speeds are used.
- ◆ FP High-Speed sync up to 1/4000 second means you can make fill-flash pictures even in bright daylight, and still maintain wide aperture settings for expanded control of depth of field.
- ◆ Before the shutter is released, Nikon's red-eye reduction lamp (on most Speedlights) lights up to reduce red-eye. This mode can be used with Slow Sync.

### Optional Finder Accessories

**DG-2 Eyepiece Magnifier (NIDG2):** Provides 2x magnification of the central portion of the finder image (needs DK-7). Eyesight adjustment provided. Useful for critical focusing in close-up photography.....**59.95**

**DK-7 Eyepiece Adapter (NIDK7):** Lets you attach the DG-2 to the F100's finder eyepiece.....**9.95**

**DK-6 Rubber Eyecup (NIDK6):** Prevents stray light from entering the viewfinder from the rear and allows eyeglass wearers to use the F100 without fear of scratching their glasses.....**9.95**

**DK-4 Right-Angle Viewing Attachment (NIDR4):** A right angle adapter, the DR-4 provides 100% viewfinder coverage from a convenient 90° angle to facilitate low-level viewing. Diopter adjusts from +4 to -4.....**129.95**

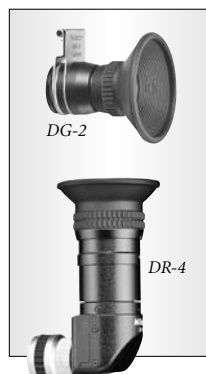

**Eyepiece Correction Lenses:** Nine optional eyepiece correction lenses from -5 to +3 allow you to adjust the diopter beyond its standard range. See page 140 for ordering info.....**16.95 ea.**

**DK-15 Anti-Fog Eyepiece Adapter (NIDK15):** This eyepiece features a transparent plastic plate with special surface coating which reduces fogging on the eyepiece.....**18.95**

**DR-4 Right-Angle Viewing Attachment (NIDR4):** A right angle adapter, the DR-4 provides 100% viewfinder coverage from a convenient 90° angle to facilitate low-level viewing. Diopter adjusts from +4 to -4.....**129.95**



**ONE HOUR FREE PARKING**  
AT 349 W. 34th STREET (with purchase of \$100 or more)

# NIKON

## F100

### Versatile Accessories

#### **E-type (Clear Matte/Fresnel with Grid) Focusing Screen** (NIFSEF100)

Etched horizontal and vertical lines added to B-type screen, the E-type screen is suitable for copying and architectural photography. Especially for use with PC-Nikkor lens .....27.95

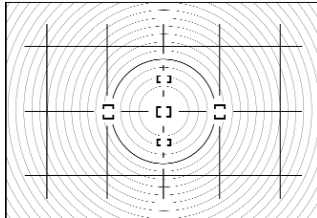

#### **MS-13 Battery Holder** (NIMS13)

Allows the F100 to operate on the power of two 3v CR-123A lithium batteries, which are lighter than the standard 4 AA alkaline batteries. The lithium batteries also offer better battery performance in low temperatures.....29.95

#### **MB-15 Multi-Power High Speed Battery Pack** (NIMB15)

The ergonomically designed MB-15 provides an alternative shutter release button, an AF start button and command dials that make shooting vertical-format pictures much more comfortable. It runs on either 6 AA alkaline or lithium batteries, or with the MN-15 NiMH battery. The MB-15 boosts film advance speed from 4.5 to 5.0 fps —regardless of the type of batteries used.....154.95

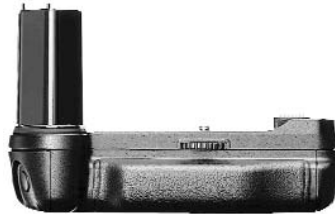

#### **MN-15 NiMH Rechargeable Battery** (NIMN15)

Exclusively designed for use with the MB-15 Multi-Power High Speed Battery Pack, the MN-15 is a NiMH rechargeable battery for convenience and improved power and speed capability up to 5 frames per second. It can be recharged approx. 500 times using the MH-15 Quick Charger .....109.95



#### **MH-15 Battery Charger** (NIMH15)

The MH-15 Ni-MH Battery Charger recharges a fully discharged MN-15 NiMH Battery in approximately 70 minutes .....249.95



#### **MF-29 Data Back** (NIMF29)

Imprints selected date and time information within frame; your choice of Year/Month/Day, Month/Day/Year, Day/Hour/Minute - or no imprint .....IMP. 119.95 /USA 139.95



Manual ISO Speed Setting



10-Pin Remote Terminal



Two-Button Reset



Depth-of-Field Preview



Focus Area Selector



Camera Back Lock Release



Top Deck LCD Panel

**Manual ISO Film Speed Setting:** You can select the film speed manually from ISO 6 to 6400 in 1/3 steps. The LCD shows you the setting. DX automatic operation is also available.

**10-Pin Remote Terminal:** Accepts Remote Cord MC-20 or MC-30 and other accessories.

**Two-Button Reset:** When you press the Exposure Mode and Custom Setting Menu buttons simultaneously for over two seconds, this returns all the F100's settings to its default settings except any Custom Settings that have been chosen.

**Depth-of-field Preview Button:** Lets you examine the zone of sharpest focus before shooting.

**Focus Area Selector:** Lets you select focus area. A lock lever is provided.

**Camera Back Lock Release:** Easy to operate and reach even when the flash bracket is attached.

**Top Deck LCD Panel:** Easy-to-see LCD gives you at-a-glance access to vital information. It can be illuminated for viewing in dim light.

CAMERAS & LENSES

109

# NIKON

## F100

**CF-57 Semi Soft Case (NICF57):** For F100 with the 28-105mm f/3-4.5D as well as all lenses which are both shorter ( up to 3.6" ) and narrower ( up to 2.9" ) .....**39.95**

**CF-58 Semi Soft Case (NICF58):** For F100 with the 70-300mm f/4-5.6D ED as well as lenses which are both shorter ( up to 4.9" ) and narrower ( up to 2.9" ) .....**44.95**

**Getting the Most from Your Nikon F100 - Instructional Video Tape (NIVTF100):** Hosted by National Geographic's Bob Krist, "Getting the Most from Your Nikon F100" covers both the fundamentals and advanced features of the camera. Join Krist on location as he explains the F100's Dynamic Autofocus operation, as well as exposure modes, flash, focus tracking and other features. Learn Krist's approach to each picture and his flair for photo composition. 60 minutes .....**24.95**



**F100 Body (NIF100):**

Includes Slip-on body cap, DK-8 Eyepiece Shield and MS-12 AA battery holder .....**899.95\*/949.95**

**Optional Eyepiece Correction Lenses for the F100**

|                     |                          |             |              |
|---------------------|--------------------------|-------------|--------------|
| <b>0 Diopter</b>    | Eyepiece correction lens | (NID08008)  | <b>16.95</b> |
| <b>+0.5 Diopter</b> | Eyepiece correction lens | (NIDP58008) | <b>16.95</b> |
| <b>+1.0 Diopter</b> | Eyepiece correction lens | (NIDP18008) | <b>16.95</b> |
| <b>+2.0 Diopter</b> | Eyepiece correction lens | (NIDP28008) | <b>16.95</b> |
| <b>+3.0 Diopter</b> | Eyepiece correction lens | (NIDP38008) | <b>16.95</b> |
| <b>-2.0 Diopter</b> | Eyepiece correction lens | (NIDM28008) | <b>16.95</b> |
| <b>-3.0 Diopter</b> | Eyepiece correction lens | (NIDM38008) | <b>16.95</b> |
| <b>-4.0 Diopter</b> | Eyepiece correction lens | (NIDM48008) | <b>16.95</b> |
| <b>-5.0 Diopter</b> | Eyepiece correction lens | (NIDM58008) | <b>16.95</b> |

### F100 Specifications

- Exposure modes: Programmed Auto (Flexible Program possible); Shutter-Priority Auto; Aperture-Priority Auto; Manual
- Viewfinder: Fixed eye-level pentaprism, built-in diopter adjustment (-3 to +1 DP), approx 96% coverage
- Focusing screen: B-type BriteView clear Matte screen III, interchangeable with optional E-type screen with grid
- AF Servo: Single Servo AF (S), Continuous Servo AF (C), Manual focus (M); Focus Tracking with Lock-On automatically activated in subject's status in Single Servo AF (S) or Continuous Servo AF (C)
- Focus area: One of five focus areas can be selected
- AF Area mode: Single Area AF and Dynamic AF (Dynamic AF Mode with Closest Subject Priority is available)
- Focus lock: Focus is locked by pressing Focus-Lock button or lightly pressing shutter release button in Single Servo AF
- Three selectable TTL full-aperture exposure metering systems: 10 segment, 3D Matrix Metering, Center-Weighted Metering (75% of the meter's sensitivity concentrated on the 12mm dia. circle) and Spot Metering (4mm dia. circle, approx. 1% of entire frame)
- Exposure compensation: ±5 EV range, in 1/3 steps
- Auto exposure lock: Detected exposure value locked by pressing AE-L button
- Auto exposure/flash: Exposure Bracketing Number of shots two or three; compensation steps: 1/3, 1/2, 2/3 or 1 steps
- Shutter speeds: In P, A: 30 to 1/8000 sec.; In S: 30 to 1/8000 sec. (in 1/3 steps); In M: 30 to 1/8000 sec. (in 1/3 steps), Bulb
- Film speed setting: DX (ISO 25-5000) or manual 6-6400 in 1/3 steps
- Flash control: Controlled by five-segment TTL Multi-Sensor; Automatic Balanced Fill-Flash with TTL Multi-Sensor, Multi-Sensor Balanced Fill-Flash, Standard TTL, Non-TTL Auto, Manual, FP Sync
- Flash sync mode: 1/250 sync, Front-Curtain Sync (normal sync), Red-Eye Reduction, Red-Eye Reduction with Slow Sync, Rear-Curtain Sync
- Self-timer: Electronically controlled; timer duration: 10 sec.
- Depth-of-field preview button: Stop-down lens aperture in all modes by pressing depth-of-field button
- Film advance speed: (with Continuous Servo AF, Manual exposure mode, shutter speed 1/250 sec. or faster, 36-exposure film) S: One frame advance, C: Continuous shooting; Approx. 4.5 fps (AA-type alkaline batteries); Approx. 5 fps (with Multi-Power High Speed Battery Pack MB-15), CS: Continuous silent-low-speed shooting; Approx. 3 fps (AA-type alkaline batteries); Approx. 3 fps (with Multi-Power High Speed Battery Pack MB-15)
- Film rewind: Automatic rewind of 36-exp. film in 9 (C) or 19 sec (CS)
- Multiple exposure: Activated using film advance mode dial 10-pin remote terminal Equipped
- Power source: AA-type battery holder MS-12 provided (four alkaline or lithium batteries); optional 3v lithium battery holder MS-13 (two CR123A); optional Multi-Power High Speed Battery Pack MB-15 (six alkaline or lithium batteries, or optional MN-15 Ni-MH battery)
- Measures 155 x 113 x 66mm (WxHxD), weighs 785g



# NIKON

## F5

### 35mm SLR Autofocus Camera

Nikon's flagship camera, the F5, offers all the features professionals demand, including dependability, accuracy, smooth handling and Nikon System compatibility - plus more. The F5 offers a range of breakthrough features such as the world's fastest autofocus operation with cross-ranged five-area AF sensors, a film advance speed of 8 frames per second (fps) even with Focus Tracking, revolutionary 3D Color Matrix Metering, and more. Many of these innovations fill the needs of professional photographers in such areas as sports, nature, fashion, photojournalism, science, and others. In addition, the F5 boasts the Nikon F lens mount, a feature which has remained virtually unchanged since the debut of the Nikon F in 1959. In this way, the F5 exemplifies Nikon's commitment to maintaining their decades-long partnership with the world's professional photographers. From its metal housing to its future-proof design, the F5 upholds the highest standards of reliability and compatibility with existing and future technologies. Indeed, it continues to be the standard for 35mm professional cameras in the 21st century.



CAMERAS & LENSES

111

### FEATURES

**The F5's combination of speed and accuracy have made it the top choice for sports and action photographers as well as photojournalists**

- ◆ The F5 offers Single Servo mode for single-frame autofocus or Continuous Servo AF operation at motor speeds up to 8 frames per second (fps) with full AF operation and Lock-On. This means that frame-after-frame—up to 8 frames per second, the F5's AF system precisely captures the subject—stationary or moving, centered or off-center, coming from left, right, top or bottom, even if there is a momentary interruption from another subject.
- ◆ In Dynamic AF mode, simply select the primary sensor (center, left, right, top or bottom) that best suits your composition. If your subject moves within the frame, the F5 automatically changes sensor to keep your subject tack sharp.
- ◆ The F5's exceptional AF performance isn't limited to average conditions—it excels under different conditions, like up-close. As a moving subject comes closer, the rate of change of the distance accelerates—and that's a problem for most AF systems: they can't keep up. The F5 keeps up at even closer distances than any other camera system.
- ◆ The F5's 5-segment AF sensor features a wide-area, cross-type design. In horizontal compositions, a complete line of sensors addresses subjects moving across the field of view. When the camera is held vertically, the cross-type design provides a line of sensors that follows the action. This sensor system works with every AF Nikkor lens.
- ◆ The F5 has a complete system of extremely reliable micro-electronics and mechanical components to provide ultra-fast operation. As subjects move quickly about the scene, the F5's micro-computers instantaneously process data. Coreless motors respond in milliseconds to drive the lens, the shutter opens and the film advances as you shoot at continuous speed up to 8 fps with autofocus. Even the mirror is designed to provide rock-steady AF operation.
- ◆ In addition to Dynamic AF operation, the F5 provides a Single Area AF mode. It's like having a choice among five carefully positioned AF spot sensors. The selected focus area is indicated on the LCD and the focusing screen.
- ◆ Choose Single Servo AF and shoot one frame at a time; use Continuous Servo AF for quick-changing situations. Either way, you'll get fast and accurate response, with sharpness you can see. You get Focus Tracking, in all AF modes, automatically activated when the F5 senses that the subject is moving. Nikon's Focus Tracking with Lock-On overcomes momentary interruptions in focus. When you want to focus manually, the accurate and versatile Electronic Rangefinder can guide you.
- ◆ For times when you want AF operation activated separately from the shutter release button, use the F5's AF start buttons—one button for horizontal, one for vertical handling. It's perfect for sports and other fast-action shooting because it lets you to concentrate solely on shutter release timing.
- ◆ The F5's built-in motor quickly rewinds the film: 4 seconds for a 36-exposure roll with the MN-30 NiMH battery, 6-seconds with fresh AA alkaline or lithium batteries—at normal temperatures. Film can also be rewound by hand.

ORDER & INFO. (212) 502-6340 • FAX: (212) 239-7770 (800) 947-7008  
1-800-290-6750 • [www.bhphotovideo.com](http://www.bhphotovideo.com)



# NIKON

## F5

### Intelligent Exposure Control

- ◆ The F5's 3D Color Matrix Meter incorporates a 1,005-pixel RGB sensor that actually evaluates a scene's colors, while AF Nikkor lenses with Distance Signal technology provide information to the meter about the quality and quantity of the light falling on the subject. When the F5 is used with the SB-800 Speedlight, a monitor pre-flash measures subject reflectance, a key element in determining exposure.
- ◆ The matrix meter evaluates all these factors, weighing them against a database of 30,000 images. Powerful Nikon software controls the entire system, integrating all the data to ensure the utmost in exposure accuracy. The results are automatic exposure control that will astonish you.
- ◆ The F5's center-weighted meter concentrates 75% of its sensitivity within the viewfinder's 12mm circle, 25% in the peripheral area—but the meter allows you to change the size of that circle to 8mm, 15mm, or 20mm to provide maximum metering versatility.
- ◆ For the highest level of exposure control, choose among the F5's five spot meters. Corresponding in position to the five sensor areas for dynamic autofocus, the F5's spot meter system provides precise metering concentration (4mm-diameter area) based on your personal exposure choices for the scene and the subject.
- ◆ Five-segment TTL Multi-Sensor precisely monitors flash output. Imperceptible monitor pre-flashes from Nikon Speedlights and distance information from D-type AF Nikkor lenses help overcome exposure failure with highly reflective surfaces, distant backgrounds, outdoor fill-flash and surfaces that don't have 18% reflectance. You can use the F5's fill-flash power together with highly automatic exposure control, or control exposure manually. Either way, you still get the proven performance of Nikon's exclusive 3D Multi-Sensor balanced fill-flash.
- ◆ Using Custom Setting #20 with Shutter Priority or Manual mode, the F5's top flash sync speed is boosted to 1/300 of a second, expanding the camera's exposure range for fill-flash shooting.



### Unequaled Versatility

- ◆ The F5 offers a wide selection of exposure control and compensation choices. There's EV compensation, AF and AE Lock controls and four exposure control systems, including Program AE, Shutter and Aperture Priority as well as full manual control plus flexible program control.
- Programmed Auto mode automatically sets the shutter speed and aperture, while Flexible Program mode allows you to shift the shutter speed and aperture combination while maintaining the correct exposure.
- Shutter Priority mode gives you a choice of speeds from 1/8000 second to 30 seconds.
- Aperture Priority mode offers a range of apertures in 1/3-stop increments.
- Manual mode turns total control of the exposure over to you.
- ◆ You can manually control exposure compensation from  $\pm 5$  EV in 1/3 EV steps. Auto Bracketing is built-in and allows you to take two or three consecutive pictures of the same scene while changing EV values in increments of 1/3, 2/3 and 1 EV. You can also select the order of the compensation, such as making the first image of the sequence with no compensation, the second with 1/3 and third at 2/3 compensation.

- ◆ Make as many images on the same frame as you wish. You can even combine Multiple Exposure Control with Exposure Bracketing and/or Exposure Compensation to achieve a variety of in-camera special effects.
- ◆ You can change the way the F5 operates by choosing from the camera's 24 built-in custom settings, which are selected using the convenient Main Command Dial. Optional backs for the F5 allow imprinting data on slides; interval timing; long exposure programming (up to 999 hours); and Freeze Focus, in which the shutter is automatically released the moment the subject enters the zone of focus.
- ◆ The F5's exposure management system combines the benefits of automatic operation and manual control. Choose from four film advance modes: Single (S), Low-Speed Continuous (CL), for up to approximately 3 fps; High-Speed Continuous (CH), for up to 8 fps; and Silent mode (CS), for near-silent operation at approximately 2 fps. Custom settings provide additional choices of motor speed rates.



The F5 is the fifth in the F series lineup which began with the Nikon F in 1959, followed by the Nikon F2 in 1971, the Nikon F3 in 1980, and the Nikon F4 in 1988. Each of these cameras incorporates the finest elements of its predecessors, including the Nikon F mount, while offering the latest innovations to meet the increasingly diversified needs of professional photographers. A great number of Nikon F series cameras and Nikkor lenses are actively working in various locations around the world - years, even decades, after their initial launch. The Nikon F5 still upholds Nikon's tradition of innovation and non-obsolescence as the new millennium approaches.

### Full Flash Control Modes

- ◆ The F5 uses five TTL sensors to precisely monitor flash output to offer versatile, capable fill-flash performance and total control of how light will affect your photograph. Choose flash compensation in 1/3 EV steps from  $\pm 3$  (with SB-800 Speedlight) to ensure natural-looking images.
- ◆ The 3D Multi-Sensor Fill-Flash allows a choice of Normal TTL Sync; Slow Sync for blurred effects; Rear-Curtain Sync (in which the flash fires at the end of the exposure); or sync at 1/300 second for fast moving subjects. In manual mode, you can use FP High-Speed Sync, which allows flash synchronization at speeds up to 1/4000 of a second.
- ◆ Automatic Balanced Fill-Flash provides auto fill-flash for every exposure mode. It will also operate during automatic exposure bracketing. The F5's advanced electro-mechanical design, which features a fast, powerful AF drive motor, provides quick, precise autofocus.



For Any Inquiries Regarding Your Order, Call Our Customer Service:  
(800) 221-5743 • (212) 239-7765 • FAX: (800) 947-2215 • (212) 239-7549



### The Ultimate in Reliability

- ◆ The F5 is strong: its major components crafted from durable metals. The chassis is made of tough aluminum alloy, rigid and strong to maintain precise alignment, as are the top shoulders, the bottom and the front-grip covers.
- ◆ The viewfinder's top cover is titanium for extra resistance to impact. Covering selected areas of this armor-like structure are rubber surfaces, textured for secure holding and for buffering against the environment and impact.
- ◆ The grip itself has a textured rubber surface. Dials and buttons are designed to resist intrusion by moisture and dust.
- ◆ The F5's design has been rigorously tested to assure reliable performance under demanding professional conditions. It is tested to resist moisture and dust. It is vibration-tested and put through extremes of temperature.
- ◆ If you've ever experienced shutter failure—shutters that sound like they're working but are not, or that have become inaccurate due to fatigue and environmental stresses, you'll appreciate the F5's Shutter Monitor. Temperatures and other conditions affect shutters, altering their performance. The Shutter Monitor checks the shutter everytime it's released. If speeds begin to shift from the calibrated speed, the camera automatically compensates to maintain an accurate exposure. If in an extreme instance the shutter fails to operate, the F5 will alert you.

### Whisper Quiet Operation

- ◆ A mirror balancer reduces noise and vibration. The F5 also has a faster-moving mirror, so it can keep up with other high-speed operations, like the motor's 8 frames per second framing rate and autofocus speed that keeps pace with the motor.
- ◆ Thanks to a floating-type design, the coreless motors and gears are quieter too. With their shock-absorber like construction, they minimize internally induced vibration. In the continuous Silent film advance mode, you get quiet film advance—not just quiet, but also with a quality of sound that isn't metallic or shrill.

## F5 Optional Accessories

### DP-30 Multi-Meter Finder (NIDP30)

The standard finder is interchangeable with three other optional viewfinders, all of which offer virtually 100% frame coverage. The high-eyepoint DP-30 enables all exposure metering systems including 3D Color Matrix. It incorporates a built-in diopter adjustment (-3 to +1) as well as a ISO-standard accessory shoe, eyepiece shutter and metering system selector.....IMP. 369.95 /USA 409.95



### DA-30 AE Action Finder (NIDA30)

Ideal when normal viewing is difficult or impossible, such as when wearing a helmet or goggles. Includes rubber hood and rubber eyepiece cover.....IMP. 829.95 /USA 979.95



### DW-30 Waist-Level Finder (NIDW30)

For use when the F5 is at a low angle or on a copystand. Fold-up type viewing hood provided. The built-in flip-up magnifier provides 5x magnification at the center of the image for accurate focusing.....IMP. 219.95 /USA 239.95



### DW-31 6x High-Magnification Finder (NIDW31)

For critical close-up work and photomicrography. It provides a sharp view of the entire image at a 6x magnification. Fitted with a -5 to +3 diopter adjustment for individual eyesight correction. Also includes a rubber eyecup and eyepiece cap.....IMP. 359.95 /USA 399.95



### MF-28 Multi-Control Back

The MF-28 enables imprinting of any of the following data: date, time, frame number, serial upcount number, fixed number, shutter speed, aperture, exposure compensation value, or any desired letters/numbers up to 6 digits inside the frame or up to 22 digits between frames. The MF-28 also enables the F5 to be used for various other advanced functions such as:



- **Interval Timer**—Commencement time, interval time, number of shots taken and number of intervals can be input
- **Auto Bracketing**—You can shoot up to 9 continuous frames, each with a different exposure
- **Long Time Exposure**—You can choose any duration from one second up to 999 seconds, 999 minutes or 999 hours
- **Freeze Focus**—Shutter is automatically released the moment the subject enters in-focus position

MF-28 Multi-Control Back (NIMF28) .....IMP. 459.95 /USA 499.95



### Data Back MF-27 (NIMF27)

A compact alternative to the MF-28, it allows you to imprint the data desired — year/month/day, month/day/year, day/year/month, day /hour/minute — or leave the blank .....IMP. 149.95 /USA 159.95

USA= Imported & Warrantied by Nikon USA

IMP. = Imported & Warrantied by B&H (not qualified for Nikon USA rebates and warranties)

# NIKON

## F5

### Interchangeable Focusing Screens

These special Nikon screens are ideal for manual focusing and as composition aids, and do not affect the F5's autofocus operation. All are made of Nikon ground glass.

**Type A (NIFSAF5):** Matte/Fresnel field with 12mm center reference circle and split-image rangefinder .....**43.50**

**Type B (NIFSBF5):** Matte/Fresnel field with 5mm diameter and 12mm-diameter reference circles and AF brackets. For general photography .....**43.50**

**Type C (NIFSCF5):** Fine-ground Matte field with 5mm diameter clear spot and crosshair. For photomicrography and other high-magnification applications using parallax focusing on aerial images .....**43.50**

**Type E (NIFSEF5):** Matte/Fresnel field with 5mm diameter and 12mm-diameter reference circles and AF brackets. For general photography .....**43.50**

**Type EC-B (NIFSECBF5):** Electrochromatic device, shows focus area selected and offers unobstructed viewing and easy focusing on the overall Matte surface .....**43.50**

**Type EC-E (NIFSECEF5):** Matte/Fresnel field with 5mm and 12mm-diameter reference circles and AF brackets, and etched horizontal and vertical lines. Ideal for architectural photography .....**99.95**

**Type G:** Clear fresnel field with extra-bright 12mm diameter microprism focusing spot for use in poor light. Models correspond to lenses with different focal lengths.

- G1 for fisheye (NIFSG1F5) .....**43.50**
- G2 for wide angle (NIFSG2F5) .....**43.50**
- G3 for 50mm f/1.2 (NIFSG3F5) .....**43.50**
- G4 for 300mm f/2.8 (NIFSG4F5) .....**43.50**

**Type J (NIFSJF5):** Matte/Fresnel field with central 5mm diameter microprism focusing spot and 12mm-diameter circle. For general photography .....**43.50**

**Type M (NIFSMF5):** Fine-ground fresnel field with 5mm diameter clear spot and crosshair for use in parallax focusing on serial images, plus millimeter scales. Suitable for close-ups, photomicrography and other high-magnification applications .....**43.50**

**Type U (NIFSUF5):** Matte/Fresnel field with 5mm and 12mm-diameter reference circles and AF brackets. Use with telephoto lenses longer than 200mm .....**43.50**

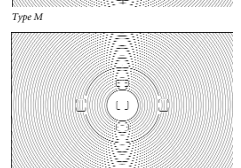
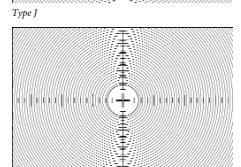
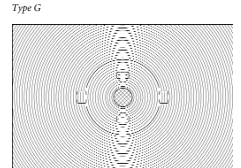
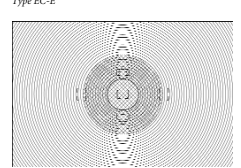
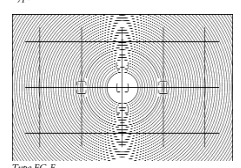
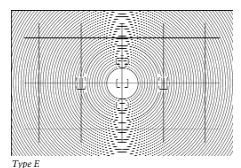
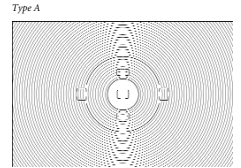
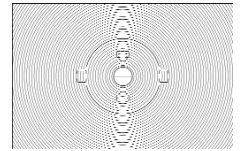

### Power Sources

The F5 comes standard with the MS-30 Battery Holder which accepts 8 AA alkaline or lithium batteries. To maximize power and speed, Nikon offers the MN-30 Rechargeable NiMH Battery for top performance.

**MN-30 Ni-MH Battery Unit (NIMN30):** Compared to regular AA-type alkaline batteries, the Ni-MH battery is more durable and maintains better performance at low temperatures .....**129.95**



**MH-30 Ni-MH Battery Charger:** Exclusive charger for the MN-30 Ni-MH Battery (NIMH30) .....**299.95**

**MC-32 External Power Cord (NIMC32)** Especially recommended when using the F5 for extended studio use, the MC-32 connects 12v external power source to the F5 .....**149.95**

### Viewing Attachments

**DK-2 Rubber Eyecup (NIDK2):** Prevents stray light from entering the viewfinder from the rear and allows eyeglass wearers to use the F5 without fear of scratching their glasses .....**9.95**

**DK-7 Eyepiece Adapter (NIDK7):** Lets you attach the DG-2 to the Multi-Meter Finder DP-30's eyepiece .....**9.95**

**DK-14 Anti-Fog Eyepiece Adapter (NIDK14):** This eyepiece features a transparent plastic plate with special surface coating which reduces fogging on the eyepiece .....**22.95**

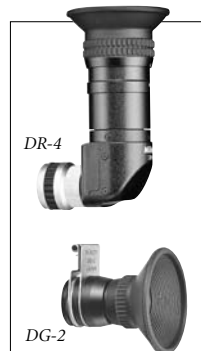

**DR-4 Right-Angle Viewing Attachment (NIDR4):** A right angle adapter, the DR-4 provides 100% viewfinder coverage from a convenient 90° angle to facilitate low-level viewing. Diopter adjusts from +4 to -4 .....**129.95**

**DG-2 Eyepiece Magnifier (NIDG2):** Provides 2x magnification of the central portion of the finder image with DK-7Adapter. Eyesight adjustment provided. Useful for critical focusing in close-up photography .....**59.95**

**Eyepiece Correction Lenses:** Five lenses (-3, -2, 0, +1 and +2m) are available. When used with the diopter adjustment dial of the Multi-Meter Finder DP-30, the combined adjustment range will extend from -5 to +4m (see next page for ordering) .....**16.95 ea.**

# NIKON

## F5 OPTIONAL ACCESSORIES

### CF-53 Semi Soft Case (NICF53):

For F5 with the 24-50mm f/3.3-4.5D lens as well as all lenses which are both shorter (up to 3.2") and narrower (up to 2.6") .....**89.95**

### CF-54 Semi Soft Case (NICF54):

For F5 with the 70-300mm f/4-5.6D ED lens as well as all lenses which are both shorter (up to 4.9") and narrower (up to 2.9") .....**114.95**

### F5 Instructional Video Tape (NIVTF5):

"How to Get Most From Your F5" shows you in detail the F5's five-sensor autofocus system, 3D Color Matrix Metering, Focus Tracking with Lock-On and more. Featuring: Peter Turner, Eddie Adams, Frans Lanting, John White and Bill Frakes Host: Joe McNally .....**24.95**



### Optional Eyepiece Correction Lenses for the F5

|                               |       |
|-------------------------------|-------|
| 0 Diopter (NID0F3HP) .....    | 16.95 |
| +1.0 Diopter (NIDP1F3HP)..... | 16.95 |
| +2.0 Diopter (NIDP2F3HP)..... | 16.95 |
| -2.0 Diopter (NIDM2F3HP)..... | 16.95 |
| -3.0 Diopter (NIDM3F3HP)..... | 16.95 |

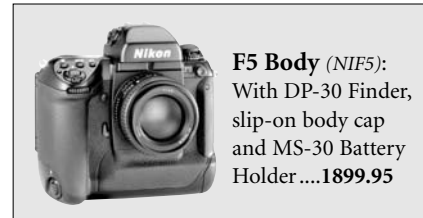

**F5 Body (NIF5):**  
With DP-30 Finder, slip-on body cap and MS-30 Battery Holder ....**1899.95**

## F5 Specifications

- Lens mount: Nikon F mount
- Focus mode: Autofocus, and Manual with Electronic Rangefinder
- AF Area mode: Single Area AF and Dynamic AF selectable
- Autofocus area: Five selectable focus areas
- Autofocus mode: Single Servo AF with Focus-Priority and Continuous Servo AF with Release-Priority
- Focus tracking: Automatically activated when subject moves
- Autofocus lock: Possible once stationary subject is in focus in Single Servo autofocus; in Continuous Servo autofocus, focus can be locked with AE-L/AF-L button
- Electronic rangefinder: In Manual focus mode with AF Nikkor and other AI-type lenses with a maximum aperture of f/5.6 or faster
- Three Exposure System: 3D Color Matrix, Center-Weighted and Spot
- Exposure mode: Programmed Auto, Shutter-Priority Auto, Aperture-Priority Auto and Manual
- Exposure compensation: ± 5 EV range, in 1/3 EV steps
- Multiple exposure: Activated with Multiple Exposure button
- Shutter speeds: from 1/8000 to 30 sec. (in 1/3 step), plus Bulb setting
- Interchangeable Viewfinder: Nikon Multi-Meter Finder DP-30 provided as standard; fixed eyelevel pentaprism high-eyepoint type; 0.75X magnification with 50mm lens set at infinity; 100% frame coverage
- Focusing screen: Nikon advanced EC-B-type screen; interchangeable with 12 other optional screens
- Depth-of-field preview button: Provides visual verification of depth-of-field, operates in all modes
- Film speed range: ISO 25 to 5000 for DX-coded film; ISO 6 to 6400 can be manually set
- Film advance: Single-frame mode, CH (Continuous High) 8 fps, CL (Continuous Low) 3fps or CS (Continuous Silent) 1fps
- Film rewind: Choice of automatic or manual; automatically rewinds when film rewind button 1 and lever 2 are used; takes approx. 4 sec. with Ni-MH battery unit and 6 sec. with eight AA-type batteries per 36-exposure roll; stops automatically when film is rewound; manual rewind when film rewind button 1 and film rewind crank are used
- Flash sync control: Normal Sync, Slow Sync and Rear-Curtain Sync built-in
- Flash synchronization: In Programmed Auto or Aperture-Priority Auto, shutter operates from 1/250 to 1/60 sec. in normal sync. 1/250 to 30 sec. in slow sync; in Shutter-Priority Auto or Manual exposure mode, shutter operates at speed set, or at 1/250 if speed is set between 1/250 and 1/8000 sec. 1/3000 TTL High-Speed Sync can be selected using Custom Setting #20 in Shutter-Priority or Manual exposure mode
- TTL Multi-Sensor: Five-segment TTL Multi-Sensor used for TTL auto flash control
- Automatic Balanced Fill-Flash with TTL Multi-Sensor: Possible with AF Nikkor lens and Nikon Speedlight SB-27, SB-26, SB-23, etc.
- Monitor Pre-flash: Nikon Speedlight SB-28/SB-27 fires Monitor Pre-flash(es) for TTL Multi-Sensor when using D-type AF Nikkor lens
- Power source: Eight AA-type Lithium batteries or optional Ni-MH Battery Unit MN-30
- Measures 6.2 x 5.9 x 3.1" (WxHxD), weights 42.7 oz.

# NIKON

## F6

### 35mm Professional SLR

Defining the pinnacle of 35mm SLR photography, the Nikon F6 is the next-legendary F-series camera. Seamlessly blending cutting-edge technologies and uncompromising craftsmanship, the flagship F6 offers film enthusiasts the finest shooting experience an SLR camera can offer. It incorporates Nikon's latest technological advancements, such as the Multi-CAM200 11-area AF system for exceptionally high-speed autofocus operation with outstanding accuracy, the i-TTL Creative Lighting System for incomparable flash photography, and a newly refined proprietary 3D Color Matrix Metering system for improved accuracy in scene recognition and exposure.

The camera also incorporates a new shutter unit crafted from DuPont Kevlar and a special aluminum alloy for unparalleled reliability, lightening-quick movement and precision. Constructed on an aluminum-alloy die-cast chassis with magnesium-alloy front body and covers (top, bottom) and strategically placed rubber surfaces, the F6 is built like a tank, and underwent many reliability and rigidity tests to ensure flawless performance.

The F6 also features a variety of exciting, innovative control options such as a customizable function button, 41 custom settings, built-in data back functions, shooting data memory and compatibility with a new Multi Power Battery Pack MB-40. This new power pack boosts the camera's framing rate from a native 5.5 frames per second to a full 8 frames per second, allowing Nikon engineers to reduce the size of the F6 significantly from the F5.

Last, Nikon engineers successfully subdued the camera's operational sounds by using a professional echoic chamber to measure sound and vibration meticulously and then craft the camera with parts that have been highly refined for absolute minimum vibration, and frequency of movement attenuated to a level below that detectable by the human ear.



#### Camera Ergonomics

In their quest for new levels of ergonomic achievement, Nikon left no part of the camera's exterior ignored. The first time you handle the F6, you're seduced by the strikingly comfortable, ergonomic design. Every curve, every undulation has been accomplished through advanced computer-aided design. But that's just the tip of the iceberg. Nikon spent unprecedented amounts



of time sculpting the contours of the grip, to ensure greater comfort and balance in the hand even during extended use. The button and dial design and layout are every bit as intelligent as they are attractive.

#### Built to Last

To ensure the high level of durability you expect from a Nikon F series SLR, the F6 has been subjected to rigorous testing. Even the lubricants applied to gear parts are carefully tested to assure peak performance in extreme temperatures and high humidity. The F6's astonishing reliability is a function of Nikon's "right material for the right place" approach.

Our engineers considered countless situations of potential camera use, then submitted the F6 to real-life testing to ensure exceptional dependability wherever and whenever you shoot. Imagine, as a photographer, the places or conditions in which you are most concerned about the toughness of your photographic tools. Now look at the F6 — an aluminum alloy die-cast chassis; magnesium-alloy front body and covers (top, bottom); strategically placed rubber surfaces; an easy-to-grip texture, and a shutter that has undergone testing to assure accurate release up to and beyond 150,000 cycles. The F6 features the strength, rigidity and durability to perform whenever you need it. Put it to the test and see for yourself.



### 11-Area High-Speed Autofocus System

Featuring 11 AF sensors — including nine cross-type sensors which cover the greater part of the viewing area — the Multi-CAM2000 AF sensor module responds quickly and delivers razor-sharp focus even in the most challenging situations. The cross-type sensors function with all AF Nikkor lenses with a maximum aperture of *f*/5.6 or faster, and enable enhanced small or low-contrast subject detection. Furthermore, large sensors help make possible smooth, swift AF operation with markedly wider defocus detection capability.

### Dynamic AF Operation

Even when shooting a moving subject, the F6's Dynamic AF ensures highly precise focusing, by shifting rapidly to the focus area to which the subject has moved. In Dynamic AF mode, one of three available modes, you can assign top priority to the most suitable focus area for your composition. Engage Closest-Subject-Priority Dynamic AF mode to have the F6 select the appropriate area for you. For optimum results when attempting to capture a moving subject, use Group Dynamic AF mode. Select several adjacent focus areas (center, top, bottom, left, right), and the camera automatically focuses on the center focus area of the selected areas.

### 3D Color Matrix Metering

The F6's 3D Color Matrix Metering offers enhanced precision thanks largely to an improved scene-detecting algorithm. It analyzes numerous aspects of the scene conditions — including brightness, contrast, selected focus area, subject-to-camera distance and color — and compares them to the reference information of more than 30,000 actual scenes in the database, ensuring super-precise exposure control and faithfully preserving the ambience of the scene.

### Flexible Center-Weighted and Spot Metering

Nikon's own flexible center-weighted metering provides you with the option of selecting the size of the sensing area in Custom Settings. Spot metering changes to correspond with the focus area you've selected.

## New Levels of Precision

### High-Precision Shutter Unit:

No shutter unit in any other camera comes close to matching the precision of the F6's assembly. Created from cutting-edge materials — DuPont Kevlar and a special aluminum alloy — the blades of the shutter unit offer unparalleled reliability and are extremely lightweight, for lightning-quick movement. For enhanced accuracy, during shutter unit development, the movement of the blades is carefully analyzed using a high-speed video camera and computer simulations, enabling unprecedented precision even at shutter speeds of up to 1/8,000 second. Shutter accuracy is maintained by the Shutter Monitor, which scrutinizes every single shutter release. Should the shutter speed vary even slightly from the calibrated speed, the camera automatically compensates to maintain accurate exposure.

### High-Speed Mirror Balancing:

A sophisticated mirror balance mechanism reduces the time required to lower the mirror. The F6's Mirror Balancer, in addition to minimizing mirror bounce, extends viewing time, allowing more time for AF operation — this is one reason the F6 can offer autofocus and Focus Tracking at motor speeds of up to 8fps, shot after wonderful shot. In conjunction with the bright, easy-to-view 0.74x viewfinder, the Mirror Balancer provides distinct advantages that give you sharper views whenever and wherever the moment happens to occur.

### Minimized Operational Sound and Vibration:

Nikon engineers were so intent on subduing the camera's operational sounds that they used a professional audio room to properly gauge the sound quality and frequency. The degree to which every part of the camera would be subjected was measured. The implementation of floating-type designs for the shutter unit, aperture control mechanics and shutter charge motor have significantly suppressed internal vibrations. This approach has resulted in virtually noise-free movement, diminished to levels unheard of with other SLR cameras. The F6 has been refined for absolute minimum vibration, to levels below detection by the human ear.

### Highly Efficient Mechanics:

The F6 marks the first time 3D computer movement analysis has ever been applied to an SLR. This technique reveals the degree of power distributed to or generated by particular components in specific directions. This made it possible for Nikon to optimize the mechanical operation of the camera with fewer parts, leading to lower power consumption and higher durability.

### Exposure Modes

- ◆ Programmed Auto (P) mode offers automatic shutter speed and aperture settings. In Flexible Program, rotate the Main-Command Dial to choose settings other than those automatically selected.
- ◆ Shutter-Priority Auto (S) lets you manually set shutter speeds ranging from 1/8,000 to 30 seconds.
- ◆ Aperture-Priority Auto (A), you can choose from available apertures in 1/3 EV steps. For complete control over exposure settings, select Manual (M) mode.
- ◆ Manually control exposure compensation from +5 EV to -5 EV in 1/3 EV steps.
- ◆ Automatic Bracketing allows you to shoot the same scene two or three times at exposure values differing in increments of 1/3, 1/2, 2/3, or 1 EV.

# NIKON

## F6

### Multiple Power Sources



Multi Power Battery Pack MB-40

The F6's standard power source, two CR123A 3v lithium batteries, enables high-speed film advance at 5.5 fps. Or you can go with the optional, multifaceted Multi Power Battery Pack MB-40 that offers up to 8 fps film advance. It requires either eight AA-size batteries or the EN-EL4 Lithium-ion Battery. The MB-40 also offers outstanding vertical shooting operation, as it incorporates a shutter release button, AF Start button, Multi-selector and Command Dials.

### Film Advance Modes

Four modes are available: Single (S), Continuous Low-Speed (CL) for up to approximately 2 frames per second (fps), Continuous High-Speed (CH) for up to 5.5 fps (or 8 fps with optional Multi-Power Battery Pack MB-40), and Continuous Silent (CS) for nearly silent operation at approximately 1 fps.

### Databack Functions

Access built-in databack functions easily via the rear LCD panel and Multi Selector. Functions include data imprint (in-frame or between-frame), multiple exposure and interval timer. You also have control over 41 Custom Settings. The recorded data of each shot can be downloaded to your computer as text data via optional Data Reader MV-1, which is equipped with a CF (CompactFlash) card.

### Nikon F-Mount

Nikon's legendary lens mount compatibility allows you to use any Nikkor lens in the incredibly deep, varied lineup. Even with older non-CPU lenses, Color Matrix Metering can still be performed after programming the lens' focal length and maximum aperture in the camera's memory. The F6 can store this data for as many as ten non-CPU lenses at a time.

### Flash and Lighting

#### i-TTL Balanced Fill-Flash

The F6 supports the i-TTL Flash Control system, providing outstanding results and myriad creative possibilities. Nikon's Creative Lighting System, the most advanced flash control system anywhere, uses a new algorithm and a brighter, shorter Monitor Pre-flash to lift the precision of i-TTL Balanced Fill-Flash even beyond that of Nikon's acclaimed 3D Multi-Sensor Balanced Fill-Flash systems. Furthermore, the Creative Lighting System allows you to employ advanced flash techniques including Advanced Wireless Lighting and FV (Flash Value) Lock.

#### Advanced Wireless Lighting

Wireless multiple flash can be performed just as easily as with an on camera Speedlight, affording you the freedom to explore the limitless creative potential of the system. You can also enjoy comprehensive control over scene lighting when using Nikon's i-TTL Speedlights SB-800/SB-600 as they can be separated into as many as four groups (the master\* and three i-TTL Speedlight groups). Control independent flash mode settings and adjustment of compensation values for each group's flash output level via the master. To pre-check a scene for illumination and shadows, there's the Modeling Flash function. Each group can comprise as many speedlights as you want, virtually putting you in total command of background lighting. (\*The SB-600 cannot be used as a master unit.)



#### Flash Value Lock (FV Lock)

Flash Value represents the degree of flash exposure for a given subject. Engaging FV Lock maintains the desired flash exposure during zooming or recomposition, allowing you to concentrate on the scene's lighting.

#### Auto FP High-Speed Sync

Enables fill-flash photography even in bright conditions at wide apertures with shallow depth of field unhindered by the standard 1/250 second flash sync. Once the mode is activated, the F6's rapid flash synchronization makes available shutter speeds faster than the camera's flash sync speed.

### Viewfinder Accessories

#### DK-17C Optional Diopter Lenses:

Five optional eyepiece correction lenses allow you to adjust the diopter beyond its standard range of -2 to +1m .....17.95

#### DK-17 Rubber Eyecup (NIDK17):

Increases viewing comfort and prevents stray light from entering the viewfinder .....14.95

#### DK-17A Antifog Finder Eyepiece (NIDK17A):

Features a special surface coating to reduce fogging on the eyepiece.....24.95

#### DR-5 Right-Angle Viewing Attachment (NIDR5):

Provides an upright, frontward facing image with right-angle viewing. Select a reproduction ratio of 1:1 or 2:1.....184.95

#### DG-2 Eyepiece Magnifier (NIDG2):

Provides 2x magnification of the central portion of the viewfinder image. Requires optional DK-7 Eyepiece Adapter for attachment to the F6 .....59.95

#### DK-7 Eyepiece Adapter (NIDK7):

Lets you attach the DG-2 to the F6 .....9.95



DK-7 Eyepiece Adapter



DG-2 Eyepiece Magnifier ▶



**ONE HOUR FREE PARKING**  
AT 349 W. 34th STREET (with purchase of \$100 or more)

## Interchangeable Focusing Screens

A wide choice of high-quality ground glass screens ideal for manual focusing or compositional aides, without influencing autofocus performance. There are seven types available (B, U, E, M, J, A, and L).

**Type B (NIFSBF6):**  
This standard screen offers unobstructed viewing and easy focusing on its overall matte surfaces...**29.95**

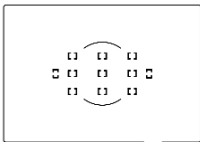
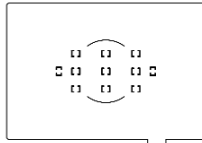

**Type U (NIFSUF6):**  
For lenses with focal lengths longer than 200mm .....**29.95**

**Type E (NIFSEF6):**  
Grid lines for accurate picture composition of architectural subjects.....**29.95**

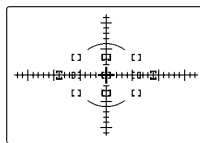
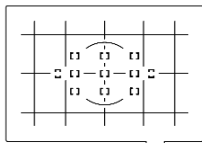

**Type M (NIFSMF6):**  
Cross hair and millimeter scales. For astrophotography & high-magnification close-ups .....**29.95**

**Type J (NIFSJF6):**  
Equipped with a microprism for use with manual focusing.....**29.95**

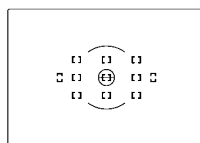
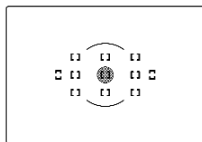

**Type A (NIFSAF6):**  
Has a matte fresnel field with split-image rangefinder and microprism collar.....**29.95**

**Type L (NIFSLF6):**  
Same as Type A but with split-image rangefinder line at a 45° angle.....**29.95**

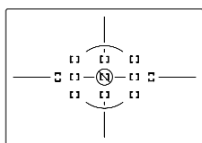

## F6 Specifications

- Type of camera: Integral-motor autofocus 35mm single-lens reflex with electronically controlled focal-plane shutter
- Exposure modes: Programmed Auto (Flexible Program possible), Shutter-Priority Auto, Aperture-Priority Auto and Manual
- Viewfinder: Fixed eye-level pentaprism, built-in diopter adjustment (-2.0 to +1)
- Focusing screen: B-type BriteView clear Matte screen II, interchangeable with six other optional focusing screens
- Viewfinder frame coverage: Approx. 100%
- Autofocus: TTL phase detection, Nikon Multi-CAM2000 autofocus module
- Autofocus detection range: Approx. EV -1 to EV 19 (ISO 100, at normal temperature)
- Focus modes: Single Servo AF and Continuous Servo AF, and Manual
- Focus Tracking: Automatically activated in Single or Continuous Servo AF
- Focus area: One — or a group — of 11 focus areas can be selected
- AF Area Modes: Single Area AF, Dynamic AF, Group Dynamic AF or Dynamic AF with Closest-Subject Priority selectable
- Focus lock: Focus is locked by pressing AE-AF-L button or lightly pressing shutter release button in Single Servo AF
- Exposure metering: 3D Color Matrix, Center-Weighted and Spot
- Exposure compensation: ±5 EV range, in 1/3, 1/2 or 1 steps
- Auto Exposure Bracketing: 2-7 shots with 1/3, 1/2, 2/3, or 1 EV compensation steps
- Film speed setting: ISO 25-5000 (DX), or manual ISO 6-6400 in 1/3 steps
- Shutter speeds: 30 to 1/8,000 (1/3 steps in S and M modes); Bulb setting available in M mode (Shutter speed can be prolonged to 30 minutes in M mode)
- Accessory shoe: ISO518 hot-shoe contact digital data communication (sync contact, ready-light contact, TTL auto flash contact, monitor contact, GND), safety lock provided
- Sync contact: X-contact only; flash synchronization up to 1/250 (up to 1/8,000 possible in AUTO FP High-Speed Sync)
- Flash control: TTL flash control by combined five-segment TTL Multi Sensor with single-component IC and 1,005-pixel RGB sensor; i-TTL Balanced Fill-Flash with SB-800/600; Film speed range in TTL auto flash: ISO 25-1000
- Sync terminal: ISO519 terminal, lock screw
- Self-timer: 10-sec. electronically controlled
- Depth-of-field preview button: Press to stop-down lens aperture
- Mirror lockup: Set using film advance mode selector
- Film advance modes: (S) One-frame advance; (CL) Continuous low-speed shooting of 2 fps or 4 fps with MB-40; (CH) Continuous high-speed shooting of 5.5 fps or 8 fps with MB-40; (CS) Continuous silent-low-speed shooting at 1 fps or 2 fps with MB-40
- Film rewind: automatic or manual; rewind speed with 36-exp. film is 7 seconds
- Multiple exposure: Activated via shooting menu
- Interval timer: Activated via menu
- Data imprint: Activated via shooting menu; in-frame, between frame and 0-frame imprint possible:
- Shooting data: Recordable number of film rolls (36 exposures): Approx. 57 rolls in basic shooting data (13 items), Approx. 31 rolls in detailed shooting data (21 items)
- 10-pin remote terminal: Equipped
- Power source: Battery holder MS-41 provided (two 3V lithium batteries); optional Multi Power Battery Pack MB-40 and AA-type battery holder MS-40 (for 8 alkaline, lithium or Ni-MH batteries, or one Rechargeable Li-ion Battery EN-EL4)
- Tripod socket: 1/4" (ISO1222)
- Custom Settings: 41 settings available
- Dimensions: 6.2 x 4.7 x 3.1" (WxHxD)
- Weight (without batteries): 34.4 oz.

# NIKON

## SPEEDLIGHTS

### *Creative Lighting Made Easy*

*Innovative Nikon technology has continuously revolutionized flash photography. Trailblazing innovations like Matrix Balanced Fill-Flash, 3D Multi-Sensor Balanced Fill-Flash, 5-Segment TTL Sensor, Distance Integration and Monitor Pre-Flash have opened new territory in speedlight functionality. Nikon speedlights let you shoot complex lighting situations with confidence, so in dim light, or even where there's no light at all, you can flex your creative muscles and always be assured of great looking pictures.*

#### **3D Multi-Sensor Balanced Fill-Flash**

The most advanced automatic balanced fill-flash technique. The camera precisely sets the appropriate flash output level using the TTL Multi Sensor which detects the monitor pre-flashes the speedlight flashes to 'test' the scene just before making the exposure.

#### **Matrix Balanced Fill-Flash**

In this technique, the matrix meter adjusts exposure for the background and then the flash exposure is controlled. This is done to balance the flash illumination so that it doesn't overpower the foreground subject.

#### **Slow Sync**

Slow sync extends the automatically controlled shutter speed range, thus enabling the background details to stand out.

#### **Rear-Curtain Sync**

Rear-curtain sync turns available light into a stream of light that follows the flash-illuminated subject. This is especially effective at slow shutter speeds.

#### **Red-Eye Reduction**

Red-eye reduction lamp lights up in advance to contract the subject's pupils, thus reducing the appearance of red-eye.

#### **FP High-Speed Sync**

With this feature, the flash output continues once the shutter curtain opens until it is fully closed. This allows flash synchronization with shutter speeds from 1/250 to 1/4000 sec.

#### **AF-Assist Illuminator**

Nikon AF Speedlights incorporates an autofocus illuminator which projects an LED pattern of light on the subject making it possible to take sharp autofocus pictures even in total darkness.



## SB-30

*The SB-30 is a versatile speedlight that offers photographers creative lighting ability in a simple, compact, and lightweight design. Weighing only 3.2 ounces, the SB-30 was designed to be ultra-compact, so that photographers could keep it on the camera nearly all the time, matching the advantages of a built-in speedlight. Plus, its automatic features offer creativity, while built-in slave flash sensor makes it an excellent second or third flash for multiple flash photography. Compact, lightweight and versatile TTL speedlight, the SB-30 is ideal as a primary flash for wide-aperture fill flash scenarios where not much pop is needed, or for macro work.*

- ◆ Works seamlessly with Nikon SLR cameras that feature TTL control, all digital SLR cameras, and select Coolpix cameras
- ◆ To make it less obtrusive, the flash's shoe allows the flash to be rotated down by 50°, nearly flush with the camera top.
- ◆ Flash can be rotated down by 50°, nearly flush with the camera top. The downward tilt makes it well suited for on-camera close-ups (up to 3.3' from the subject).
- ◆ A safety lock system ensures that the SB-30 is tightly fastened to the camera in use.
- ◆ The SB-30 covers a wide-angle area of 28mm, and can cover up to 17mm with the built-in wide flash filter.
- ◆ Has a guide number of 52 (at 28mm setting, ISO 100), and a recycle time of four seconds in full power manual mode (with fresh batteries).
- ◆ At 3.2 ounces, you can mount this speedlight on a camera and shoot comfortably, without noticing a significant change in camera weight and handling.
- ◆ Encapsulated in the SB-30 is an advanced circuitry that provides users with features typically found in higher-end flash units.
  - Built-in wireless mode lets the SB-30 fire synchronously, triggered from as far as 23' (auto mode) or 131' (manual mode) by other speedlights.
  - Using its built-in infrared filter, the SB-30 can act as a remote commander for triggering other Nikon speedlights during a multiple flash set-up.

**SB-30 Speedlight (NISB30) .....84.95**





# NIKON

## SB-50DX



The SB-50DX is a high-performance, compact and lightweight flash that offers photographers enhanced creative flash performance that's easy! Designed to expand the creative picture-taking capabilities of Nikon 35mm and professional digital SLR cameras, the SB-50DX simplifies otherwise complex processes. When used with a Nikon N75 or N80, it provides a variety of features that complement the camera's built-in speedlight. The

SB-50DX can serve as a bounce flash, an extra-wide flash using its adapter for 14mm wide-angle coverage, TTL wireless slave flash, as an infrared remote commander to trigger off camera wireless TTL or manually controlled speedlights, and for close up shooting, as well. Features 3D Multi-Sensor Balanced Fill-Flash capability, a GN of 72 (ISO 100/feet) at 35mm position, and minimum recycling time of 3.5 seconds.

- ◆ Guide Number of 72 (ISO 100/feet) at 35mm position when used as accessory speedlight. Combined Guide Number of 82 (ISO 100/feet) when used in combination with N80 or N75's built-in speedlight.
- ◆ Operates in combination with Nikon's built-in SLR speedlights for an easy two-light on camera TTL flash system. The SB-50DX in bounce position and built-in speedlight operating with TTL precision provides more reach or supplemental bounce illumination.
- ◆ Up to 260 flashes in full Manual mode with 2 CR-123A lithium batteries
- ◆ Auto-zoom (24 to 50mm) flash head tilts up 90° for bounce flash or down to -18° for close up shooting (up to 11.8 inches).
- ◆ AF-Assist Illuminator automatically fires an LED beam toward the subject to augment dim light or dark conditions.
- ◆ Slow and Rear-Curtain Sync controlled from the camera automatically sets the shutter from 30 seconds to the highest sync speed.
- ◆ Ready-light indicates charge level; flash button for test firing; 14mm wide flash adapter and diffuser for bounce operation
- ◆ 3D Multi-Sensor Balanced Fill-Flash with F5, F100, N90s and N80 35mm AF SLRs
- ◆ Built-in flash compensation from +/-3 EV in 1/6 EV steps (digital)
- ◆ Can be used as a wireless slave flash with TTL Auto Control in multiple flash set-up, or used on camera to trigger other Nikon TTL speedlights using the supplied SW-91R Infra-red filter. (Effective range up to 23' in auto mode, 130' in manual mode).
- ◆ Safety lock prevents the SB-50DX from accidentally slipping off the camera's flash shoe.

SB-50DX Speedlight (NISB50DX).....164.95

## SB-600

### *i-TTL Shoe Mount Flash*

Featuring Nikon's next generation *i-TTL* flash control technology, the versatile SB-600 delivers automatic balance fill-flash and advanced wireless lighting capabilities for outstanding results and creative possibilities. (The SB-600 is also seamlessly compatible with the D70 digital SLR camera's built-in speedlight as well as the D2H professional digital SLR. The SB-600 effectively integrates with the SB-800 Speedlight, both individually and in arrangements of multiple SB-600/800 speedlights, offering consistent *i-TTL* control for automatic and accurate lighting for creative and complex situations. Designed for a variety of users ranging from experienced and amateur photographers to beginning enthusiasts, the SB-600 incorporates a host of new features designed to make flash photography simple, accurate and creative.

The SB-600 speedlight features wireless TTL technology first introduced with the SB-800 Speedlight. Photographers using the SB-800 as the Controller can employ up to three groups of compatible Speedlights, with any quantity of compatible SB-600 and SB-800 speedlights within each of the three groups, to achieve Advanced Wireless *i-TTL* exposure control. Most major functions of the SB-600 can be controlled remotely by the master SB-800. The SB-600 can be remotely controlled either in *i-TTL* mode or manual mode for maximum creativity. In addition to the wireless capabilities, the SB-600 offers a host of additional features for Nikon's Creative Lighting System.



# NIKON

## SB-600 con't

- ◆ Includes support for Nikon Advanced wireless TTL operation, and can function as a remote flash when controlled by the SB-800 or the D70 digital SLR's built-in speedlight. Additionally, the SB-600's Auto FP High Speed Sync Mode allows it to fire at up to 1/8000 second shutter speed when used with the D2H digital SLR camera.
- ◆ Built-in modeling flash fires a stroboscopic burst of light for approximately one second, allowing photographers to visually confirm lighting and shadow effects before shooting.
- ◆ Offers a full manual mode with power ratios from full power to 1/64 power, in 1/2 step increments for independent flash output control and creative lighting effects.
- ◆ Custom settings allow you to personalize the speedlight according to selected preferences.
- ◆ Equipped with a wide area illuminator that assumes autofocus assist functions in low light conditions. The Illuminator covers all AF-points in all Nikon SLR cameras, giving photographers the freedom to compose their shots creatively and shoot with confidence.
- ◆ Compatible with all Nikon digital and film SLR cameras, achieving performance that is limited by each camera's capability:
  - Will realize full i-TTL control when used with the D2H or D70 digital SLR cameras
  - D-TTL control and Auto Aperture Flash (AA) when used with Nikon digital SLR cameras.
  - The SB-600 offers TTL and non-TTL Auto Flash control when used with all Nikon film SLR cameras.
- ◆ LCD provides large, easy to read graphics, and ergonomic control design makes buttons and switches simple to access and use.
- ◆ Optional accessory filters for special color effects and emulation of fluorescent and incandescent lighting are available. The SB-600 is compatible with Nikon's SJ-1 Color Filter Set—eight color filters, including filters for balancing tungsten lighting, fluorescent lighting, red, blue, yellow and amber for special effects
- ◆ Additional features include a rotating flash head which tilts horizontally and vertically, front and side ready-light indicators for easy viewing, and a locking flash shoe.

SB-600 (NISB600) .....194.95

## SB-800

*The ultimate speedlight for photographers requiring maximum automation, integration, and control, the SB-800's i-TTL system supports advanced wireless lighting and versatile functions for up to four groups of speedlights, with three remote SB-600/SB-800's controlled through the master SB-800. i-TTL (intelligent-through-the-lens) Balanced Fill-Flash flash control employs Nikon's Advanced Data Communication system to introduce an improved method for the monitor pre-flash and wireless operation—making wireless multiple flash photography as automatic as a single on-camera speedlight.*



### Automatic Wireless Multi-Flash

At the heart of the Nikon Creative Lighting System is the advanced data communications technology, which provides complete control of any number of remote speedlights from the camera position. You can independently manage up to four groups of remotely positioned SB-600/SB-800 Speedlights from and SB-800 operating as the master controller, attached via the SC-29 AF Off-Camera TTL cord.

- ◆ With all groups set for i-TTL the camera measures pre-flash information from each group and determines the exposure virtually instantaneously for maximum automation and ease of use.
- ◆ Select a different flash mode for each group—including master controller) for lighting control based on the brightness of the subject and not on general output ratios for each group—manual mode for one, AA (Aperture Auto) for another, Flash Compensation with i-TTL for the third, i-TTL for the master controller—and adjust settings for each from the camera position.
- ◆ Auto flash control is set to match the camera body: i-TTL Balanced Fill-Flash control with the D2H, D-TTL Balanced Fill-Flash control and Auto Aperture Flash (AA) with D1 Series and D100 digital SLR cameras, and TTL and Non-TTL Auto Flash (A) with film cameras
- ◆ A flash version of AE (Auto Exposure) Lock, FV (Flash EV) Lock lets you change the composition or zoom for the shot while maintaining desired lighting of the subject. Operates in i-TTL and AA modes, as well as FP mode, and with all wireless SB-800 groups.

### Additional Features

- ◆ Built-in wide-area AF Illuminator is compatible with every AF Nikkor lens
- ◆ Distance Priority manual flash mode, for automatic power setting of manual mode flash based on f/stop, distance and ISO. A great feature for manual flash [M] shooting at weddings and for product shots
- ◆ Modeling flash for preview of flash effects
- ◆ Custom settings for greater control
- ◆ GN 184 (ft. at ISO 100) at 105mm
- ◆ ±3 EV flash compensation in 1/3 EV steps
- ◆ Super-large dot matrix LCD with graphical user interface offering easy-to-read graphics
- ◆ Supplied SD-800 Quick Recycling Battery Pack adds a fifth battery to shorten recycle time to as little as 2.9-seconds
- ◆ Supplied SJ-800 Color Filter system includes TN-A1 tungsten and FL-G1 fluorescent filters. Also includes AS-19 stand, soft case and SW-10H Diffusion Dome.

SB-800 (NISB800) .....319.95



For Any Inquiries Regarding Your Order, Call Our Customer Service:  
 (800) 221-5743 • (212) 239-7765 • FAX: (800) 947-2215 • (212) 239-7549

# NIKON

## SPEEDLIGHT ACCESSORIES

### SK-6 Power Bracket (NISK6)

External power unit and mounting bracket combination. Reduces flash recycling by half while nearly doubling the amount of available flashes. Offers convenient, adjustable side-mounted handle for entire camera/speedlight system, or for creative lighting effects when unit is detached from camera. Camera, flash and all other necessary connections are made within this single unit. Requires 4 AA batteries. Compatible with the SB-800 and F5, F100, N80 and N75.....**264.95**



### SU-4 TTL Wireless Slave Flash Controller (NISU4SG2)



Attached to any current Nikon Speedlight and many previous models, the SU-4 enables wireless remote slave flash with automatic TTL or manual exposure control. The SU-4 detects the firing of the master flash (including built-in speedlights) and sends firing start signal to the slaved unit. The SU-4 stops the firing of the slaved flash by detecting the firing stop of the master flash. Eliminates the use of connecting cords. Operates up to 23' from the location of the main flash.....**74.95**

**SK-7 Bracket:** For SU-4 Wireless Slave Flash Controller. Allows you to position camera and SU-4 side by side..**19.95**



### SD-7 DC Power Supply (NISD7)

Operates on six C-type batteries and offers a separate power source for the SB-800 and optional SK-6 Power Bracket. Shortens flash recycling and dramatically increases flash capacity. Includes SC-16 Power Connecting Cord .....**129.95**



### SD-8A High Performance Battery Pack (NISD8A)

Shortens flash recycling time by as much as 60 to 75% and more than doubles flash capacity. Operates on 6 AA alkaline, lithium or nicad batteries. Compatible with the SB-800 Speedlite as well as the SK-6 Power Bracket.....**119.95**

### SJ-1 Color Filter Set (NISJ1)

Includes 20 color-balancing filters developed for Nikon cameras and designed to either compensate for flash or to add creative expression: TN-A1 and TN-A2 Tungsten Balancing and FL-G1 and FL-G2 Fluorescent Balancing in clear, red, yellow, blue, and amber. Compatible with the SB-50DX, SB-600 and SB-800 .....**19.95**

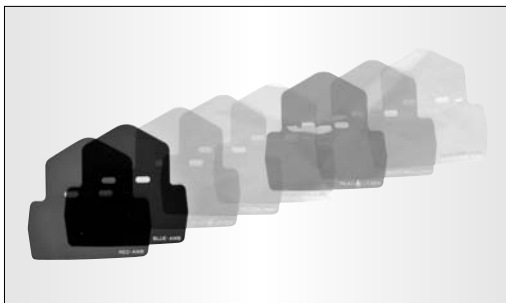

### SC-24 TTL Cord (NISC24)

For TTL flash control when using the F5 and DW-30 or DW-31 finders. (It ONLY fits the above mentioned viewfinders which have a dedicated terminal specific to this cord. SC-18/19 cords can be used as extensions from the shoe-end of the SC-24 .....**59.95**



### SC-26 and SC-27 TTL Multi-Flash Sync Cords

Use these cords to connect TTL flash units to each other or through the AS-10 TTL Multi-Flash Adapter or SC-28 TTL Remote Cord for multi-flash operation. SC-26 is 5' long, the SC-27 is 10' long. NISC26.....**29.95** NISC27.....**39.95**

### SC-28 TTL Remote Cord (NISC28)

A 3' coiled cord that connects multiple SB-600 and SB-800's to Nikon SLRs with a standard ISO accessory shoe (F5, F100, N80, N75). Up to two units can be connected to the SC-28's terminals via the SC-26 or SC-27 TTL Multi-Flash Sync Cord for TTL multi-flash photography .....**54.95**

### SC-29 Off-Camera TTL Cord (NISC28)

The SC-29 mounts to the camera's hot shoe, enabling an attached SB-600, SB-800 flash to accurately autofocus in low light when placed on a flash bracket, for beautiful shadowless lighting. The cord incorporates an AF illuminator at the mounting point that overrides the SB-600/SB-800's AF Illuminator eliminating any discrepancies when using them off-camera.....**74.95**



### AS-19 Speedlight Stand (NIAS19)

Lets you set up your flash on any flat surface. Compatible with all Nikon flashes except the SB-29s .....**7.95**

CAMERAS & LENSES

123

# NIKON

## SB-29s

CAMERAS & LENSES

124



### Macro Speedlight

This speedlight lets you use TTL automatic exposure for shadowless wrap around macro photography. Two built-in flash modules provide full-surround illumination, so you can flawlessly capture the details of the world in miniature, without distracting shadows. This flexible unit lets you adjust the flash output to have either the right or left modules flash, or both together. You can even set the flash output balance (left:right, right:left) to 1:4. Moreover, modeling flash mode lets you see through the viewfinder what effect the flash will have on your scene before you take the shot.

- ◆ TTL automatic control with Nikon F5, F100, N80 and N75; Non-TTL automatic control; manual control (full, 1/2, 1/4, 1/8 and 1/16 output)
- ◆ Guide Number 112 (with zoom head set at 50mm)
- ◆ Convenient focus illuminator ensures pinpoint focus adjustment, and a wide illumination panel lets you shoot flash-to-subject distances closer than 1.6".
- ◆ Two flash tubes provide extremely accurate TTL flash control during ultra close-up photography
- ◆ Main unit can be attached to controller on top of hot shoe; flash brightness can be reduced down to 1/4 power; modeling flash mode lets you see what effect the flash will have on your scene before you shoot.
- ◆ Easy-to-read reproduction-ratio scale on back of the controller is matched to Micro Nikkor lenses
- ◆ Multiple flash compatibility includes: SC-26 and SC-27 cords and SU-4 Wireless Slave Flash Controller for TTL operation.
- ◆ Powered by 4 AA alkaline, lithium, nicad or NiMH batteries

SB-29s (NISB29S).....IMP. 334.95 /USA 359.95

## Remote Control Accessories for the F5 and F100

Nikon remote controls let you stay out-of-sight while your camera stays within range. Now you can shoot without disturbing the action.



**ML-3 Modulite Remote Control Set (NIML3)**  
The ML-3 is a 10-pin auto triggering device with delayed shutter release for the F5 and F100. The ML-3 offers remote control for two separate channels via an infrared LED beam, enabling automatic operation from a distance of up to 26'. Auto triggering, delayed shutter release, single and continuous shooting are possible. Transmitter is powered by two AAA batteries, the receiver by the camera .....**169.95**

**MC-20 Remote Cord with Timer (NIMC20)**  
Enables remote firing (2.6' locking electronic cable release) and long time-exposures settings (up to 10 hours) for the F5 and F100. An illuminated LCD panel counts exposure time up or down. Provides both B and T operation .....**104.95**

**MC-30 Remote Cord (NIMC30)**  
A 32" standard (10-pin) remote release cord that enables remote firing of a camera with trigger-lock function .....**54.95**



**MC-21 Extension Cord (NIMC21)**  
The MC-21 is a 9.9' extension cord that's used with the MC-20, MC-30 or MC-22 .....**63.95**



**MC-23 Connecting Cord (NIMC23)**  
The MC-23 is 1.3' cord for connecting two cameras for simultaneous or synchronized shutter release.....**49.95**

**MC-25 10-Pin Adapter Cord (NIMC25)**  
An 8" adapter cord, the MC-25 enables use of two- or three-pin Nikon remote accessories like the MC-12B with the 10-pin remote terminal of the F5 and F100 .....**59.95**

**MC-12B Remote Trigger Cord (NIMC12B)**  
Equipped with convenient handgrip, trigger release button and trigger lock lever, the MC-12B provides remote control photography up to 2.6' away. Depressing the button halfway turns on the camera's exposure meter, depressing fully, releases the shutter. Trigger lock enables time exposures (F5 and F100 require the MC-25 Adapter Cable).....**49.95**



## NIKON CLOSE-UP ACCESSORIES

### Close-up Attachment Lenses

Nikon's easy-to-use close-up lenses screw directly into the front thread of your lens—a simple, easy way to increase magnification. Even when attached, you can still use automatic exposure control and TTL metering. To improve image contrast and reduce flare, lenses are treated with Nikon Integrated Coating.



Close-up lenses 1 and 2 are for lenses with a focal length up to 55mm. 3T, 4T, 5T and 6T are two-element achromatic lenses that ensure a high image quality. 3T and 4T work best with 85mm to 200mm lenses, and 5T and 6T with lenses from 70mm to 210mm. 5T and 6T have a 62mm front attachment size; all others 52mm.

The higher the lens numbers, the closer you can focus. For the prime lens, the longer the focal length the greater the reproduction ratio you can obtain. Use singularly or in combination.

- 52mm #1 Close-up Lens (NICUL152) .....36.95
- 52mm #2 Close-up Lens (NICUL252) .....36.95
- 52mm #3T Close-up Lens (NICUL3T52) .....36.95
- 52mm #4T Close-up Lens (NICUL4T52) .....36.95
- 62mm #5T Close-up Lens (NICUL5T62) .....46.95
- 62mm #6T Close-up Lens (NICUL6T62) .....46.95

### PK/PN Auto Extension Rings



Nikon's Auto Extension Rings mount on or off your camera in seconds for a wide range of reproduction ratios. They fit between the camera body and lens either alone or in combinations, and retain automatic diaphragm and meter coupling with Nikon lenses. This means you can compose, focus and meter at the brightest fullest aperture position without having to manually stop down the lens before shooting. They also allow automatic exposure control.

- PN-11 (NIPN11) .....96.95
- PK-11A (NIPK11A) .....59.95
- PK-12 (NIPK12) .....59.95
- PK-13 (NIPK13) .....62.95

### Bellows Focusing Attachment and Accessories

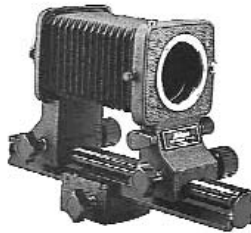

#### PB-6 Bellows Focusing Attachment (NIPB6):

A real gem of the Nikon close-up photography system is the superbly crafted PB-6. A twist of the knob lets you vary the lens extension at will, producing frame-filling images of the most minute subjects. Provides continuously variable extension from 48mm to 208mm. The PK-12 Auto Extension Ring is required when the PB-6 is used with the F5.....229.95

#### PB-6D Bellows Spacer (NIPB6D)

Enables you to move an F5 on the PB-6 rail without interference. The PB-6D also allows horizontal/vertical changeover anywhere along the rail. Two PB-6Ds are needed with the PB-6; three are needed when using the PB-6E .....53.95

#### PB-6E Extension Bellows (NIPB6E)

Attaches to the PB-6 for magnification to an astounding 23x life-size when using a 20mm wide angle lens in reverse position.....159.95

#### PS-6 Slide Copying Adapter (NIPS6)

Used with the PB-6 and a Nikkor lens to make duplicate slides. Cropping of the original is possible .....129.95

#### PB-6M Macro Copy Stand (NIPB6M)

A stand for small items that attaches to the PB-6 Bellows Focusing Unit.....44.95

#### PG-2 Focusing Stage (NIPG2)

Simplifies close-up focusing when using a camera or camera plus motor drive mounted on a tripod .....149.95

#### BR-2A Macro Adapter Ring (NIBR2A)

Fits between the camera and lens to enable reverse-mounting of lenses. It is an inexpensive means of obtaining a relatively high reproduction ratio. The BR-2A also increases the working distance for normal or wide angle lenses. The BR-2A is compatible with lenses that have a 52mm front attachment size .....23.95



#### BR-5 Macro Adapter Ring (NIBR5)

Needed when using the BR-2A Macro Adapter Ring with lenses that have a 62mm front attachment size.....23.95

#### BR-3 Adapter Ring (NIBR3)

Converts the bayonet mount of reverse mounted lenses to the 52mm thread used for filters and hoods .....23.95

#### ES-1 Slide Copying Adapter (NIES1)

The ES-1 enables duplication of 35mm film. It attaches to the Micro-Nikkor 55mm f/2.8 lens, or to the AF Micro-Nikkor 60mm f/2.8D lens with an optional BR-5 Ring.....49.95



#### AR-7 and AR-10 Double Cable Releases

The AR-7 and AR-10 Cable Releases provide the PB-6 with automatic diaphragm control, even for a lens in the reversed position.

AR-7 (NIAR7): For the FM10, FM3a, N55, N75, and N80 cameras .....42.95

AR-10 (NIAR10): For the F5 and F100. Requires the optional MC-25 Adapter Cord .....67.95

# NIKON

## AF NIKKOR LENSES

When it comes to choosing photographic equipment, perhaps the most important decision a photographer faces is which lens system to use. For the majority of professional photographers, that choice is simple: Nikkor. The reasons for this are many, not the least of which is Nikon's total commitment to controlling every aspect of lens manufacturing. This no-compromise attitude toward manufacturing extends performance. For each Nikkor lens is designed to function seamlessly with Nikon SLRs. This is exemplified most clearly in the legendary Nikon F mount. Even the most advanced Nikkor lenses incorporate this standard for its consistency and reliability. This design also ensures that when Nikon introduces new cameras with revolutionary features such as 3D Color Matrix Metering and Multi-Sensor Balanced Fill-Flash, you'll always have an array of lenses available to handle these advances.



### AF D-type Nikkor Lenses

AF Nikkor D-type lenses are special because they relay subject-to-camera distance information to AF Nikon camera bodies that use the information. This makes possible new technologies like Nikon's 3D Color Matrix Metering and 3D Multi-Sensor Balanced Fill-Flash.

### Aspherical Lens Elements

Nikon introduced the first photographic lens with aspherical lens elements in 1968. Aspherical lenses minimize the problem of coma and other types of lens distortion—even when used at the widest aperture. They are particularly useful in correcting the distortion in wide-angle lenses. In addition, use of aspherical lenses contributes to a lighter and smaller lens design.

### ED Glass

Nikon developed ED (Extra-low Dispersion) glass to make telephoto lenses that offer superior sharpness and color correction by minimizing chromatic aberration. (Chromatic aberration is a type of image and color distortion that occurs when light rays of varying wavelengths pass through optical glass). ED lenses deliver stunning sharpness and contrast even at their largest maximum apertures.

### Nikon Integrated Coating (NIC)

To enhance the performance of lens elements, Nikon employs sophisticated multi-layer coating to help reduce ghost and flare to negligible levels. Nikon Integrated Coating (NIC) minimizes reflections over a wide wavelength range, and enhances color balancing. It is carefully integrated into the design of each Nikkor lens type, with the coatings calculated to match the lens type and glass.

### Close-Range Correction System

Providing superior picture quality at close focusing distances and increasing the close focus range, the Close-Range Correction (CRC) system is one of Nikon's most important focusing innovations. With CRC, the lens elements are configured in "floating element" design wherein each lens group moves independently to achieve focusing. This ensures superior lens performance even when shooting very close.

### Internal Focusing

Imagine being able to focus a lens without it changing in size. Nikon's IF technology enables just that. All internal optical movement is limited to the interior of the non-extending lens barrel. This allows for a more compact, lightweight construction as well as a closer focusing distance.

### Rear Focusing (RF)

With Nikon's Rear Focusing (RF) system, all the lens elements are divided into specific groups, with only the rear lens group moving to conduct focusing. As with IF, this technique makes autofocus operation smoother and faster.

### AF-S Technology

AF-S lenses feature Nikon's Silent Wave Motor (SWM) which converts "traveling waves" into rotational energy to focus the optics. This enables high-speed autofocus that's extremely accurate and quiet.

### M/A Mode

AF-S lenses also feature Nikon's exclusive M/A mode, that allows switching from autofocus to manual operation with virtually no time lag – even during AF servo operation.

### Vibration Reduction System

Stability is critical for telephoto and close-up photography. Nikon Vibration Reduction (VR) technology automatically compensates for camera shake to ensure sharp pictures at slower shutter speeds. If you can steadily hand-hold at 1/125 second, VR will enable you to shoot at about 1/15 second. The system even automatically detects and compensates for panning when the camera is following a moving subject.

### AF DC-Nikkor Lenses

A set of unique lenses for unique portraits, exclusive AF DC (Defocus-image Control) technology allows photographers to control the degree of spherical aberration in the foreground or background by rotating the lens' DC ring. This will create a rounded out-of-focus blur that is ideal for portrait photography.

# NIKON

## AF NIKKOR LENSES

### FISHEYE and ULTRA WIDE ANGLE LENSES

#### **AF 14mm f/2.8D ED** (NI1428DAF)

Fast, ultra wide angle lens offers a 114° angle of view. Ideal for shooting interiors, real estate, landscape or special effects. Rectilinear design renders images that are amazingly true and undistorted. ED glass and two aspheric lens elements provide superior image quality and compact size, as well as minimized distortion and aberration. A/M switch for quick shifting from automatic to manual focusing. Built-in lens hood minimizes ghosting and enhances contrast. Includes CL-S2 soft case. Filtering is possible using the integrated gelatin filter holder.....IMP. 1229.95 /USA 1399.95

#### **AF Fisheye 16mm f/2.8D** (NI1628DAF)

Full frame 180° fisheye coverage with D-type autofocus lens technology. Delivers high-contrast images even at full aperture. CRC system provides high performance at both near and far focusing distances. Super Integrated Coating minimizes flare and ghosting. Filter size is 39mm bayonet.....IMP. 599.95 /USA 729.95



AF 18mm f/2.8D, top  
AF 14mm f/2.8D ED, bottom

#### **AF 18mm f/2.8D** (NI1828DAF)

Compact ultra wide angle with aspherical lens element and rear focusing capability, the AF 18mm f/2.8D's outstanding image correction quality makes it ideal for architecture and landscape photography. Superb center-to-edge sharpness with excellent control of distortion and aberration. Includes CL-47 case and HB-8 hood. Filter size is 77mm.....IMP. 959.95 /USA 1299.95

#### **AF 20mm f/2.8D** (NI2028DAF)

Compact ultra wide angle lens, the AF 20/2.8D features Close Range Correction (CRC) to provides high performance at both near and far focusing distances. Delivers distortion-free pictures as close as 0.85". Superb optical design for architecture, wedding and landscape photography. Nikon Integrated Coating for minimized flare and ghosting. Filter size is 62mm .....IMP. 439.95 /USA 479.95

CAMERAS & LENSES

127

USA= Imported & Warrantied by Nikon USA

IMP. = Imported & Warrantied by B&H (not qualified for Nikon USA rebates and warranties)

### WIDE ANGLE and NORMAL LENSES

#### **AF 24mm f/2.8D** (NI2428DAF)

Compact and lightweight, the AF 24/2.8D is ideal for candid and landscapes. Close Range Correction system provides high performance at both near and far focusing. 52mm filter size .....IMP. 279.95 /USA 299.95

#### **AF 28mm f/2.8D** (NI2828DAF)

Standard wide-angle lens for general photography, the AF 28/2.8D is exceptionally light, weighing only 7.4oz. Wide 74° coverage lets you take candid, portraits and travel photos. 52mm filter size .....IMP. 199.95 /USA 224.95

#### **AF 28mm f/1.4D** (NI2814DAF)

Compact lens with Nikon's Rear Focus system for fast, smooth autofocusing. Exceptionally large aperture makes it perfect for low-light photography—indoors or out. Precision ground-glass aspherical lens elements minimize distortion and coma. Filter size is 72mm.....IMP. 1449.95 /USA 1694.95



AF 50mm f/1.4D

AF 35mm f/2D

AF 28mm f/1.4D

#### **AF 35mm f/2D** (NI352DAF)

Versatile wide-angle lens for a broad range of uses, the fast f/2 maximum aperture make it ideal for low light, hand-held shooting. Perfect for the photographer on the go. Filter size is 52mm.....IMP. 259.95 /USA 299.95

#### **AF 50mm f/1.8D** (NI5018DAF)

Compact and very affordable Nikon lens that combines the ease of autofocus operation with advanced Nikon optics. Ideal for scenery or full-length portraits. Steps down to f/22 providing great depth-of-field control. Filter size is 52mm.....IMP. 89.95 /USA 99.95

#### **AF 50mm f/1.4D** (NI5014DAF)

A high-speed normal lens, the AF 50mm f/1.4 is great for travel and for shooting full-length portraits in available light. High-contrast and distortion-free images with superb resolution and color, even at maximum aperture. Filter size is 52mm.....IMP. 229.95 /USA 264.95

ORDER & INFO. (212) 502-6340 • FAX: (212) 239-7770 (800) 947-7008  
1-800-290-6750 • www.bhphotovideo.com



# NIKON

## AF NIKKOR LENSES

### MACRO LENSES



AF 105mm  
f/2.8D Micro

#### **AF 60mm f/2.8D Micro** (NI6028DMAF)

A versatile and compact macro lens, the AF 60mm f/2.8D Micro is ideal for photomicrography, forensic, flora, flat field copy, as well as candids and landscape photography. Close-Range Correction (CRC) system provides high performance at both near and far focusing distances. Continuous focusing from infinity to life-size (1:1). Close-up to approximately 8.6". Filter size is 62mm.....IMP. 339.95 /USA 379.95

#### **AF 105mm f/2.8D Micro** (NI10528DMAF)

Medium telephoto macro lens for portrait and other high magnification close-up applications, the AF 105mm f/2.8D Micro provides extra working distance for elusive subjects or ones requiring supplemental illumination. Close-Range Correction (CRC) system provides high performance at near and far focusing distances. Continuous focusing from infinity to life-size (1:1). Close-up to 12.4". Filter size is 52mm.....IMP. 539.95 /USA 649.95

#### **AF 200mm f/4D Micro** (NI2004DMAF)

A legendary close-up lens, the AF 200mm f/4D Micro delivers images of striking clarity while providing reproduction ratios of up to 1:1 without additional accessories. Extra Low Dispersion (ED) glass ensures apochromatic-like performance, with high contrast and sharper images, while the extra long focal length provides versatile working distance. Also offers internal focusing and an A/M (Automatic/Manual) switch. Continuous focusing from infinity to life-size. Close-up to 19.4". Filter size is 62mm .....1324.95



### PORTRAIT and TELEPHOTO LENSES



AF 180mm f/2.8D ED-IF

#### **AF 85mm f/1.8D** (NI8518DAF)

Compact and lightweight, the high-speed AF 85mm f/1.8D is perfect for indoor or outdoor portrait shooting. RF (Rear Focusing) technology provides fast AF operation. Includes HN-23 lens hood. Filter size is 62mm .....IMP. 319.95 /USA 384.95

#### **85mm f/1.4D IF** (NI8514DAF)

Fast f/1.4 aperture makes this lens a standout for indoor portraits, sports, and all-around photo journalism. The lens' aperture has extra blades, enabling the diaphragm shape to be a near-perfect circle. This ensures crisper images and more flattering highlights in the out-of-focus portion of the image. Internal focusing technology guarantees fast autofocus operation. Includes HN-31 lens hood. Filter size is 77mm .....IMP. 859.95 /USA 999.95



AF 135mm f/2D

#### **AF 105mm f/2D DC** (NI1052DAF)

A fast, medium telephoto, this lens features Defocus-image Control, allowing you to create a rounded out-of-focus blur that is ideal for portrait photography. Large aperture permits shooting in low-light, while the rounded diaphragm opening makes out-of-focus elements appear more natural. Rear focusing technology for fast AF operation. Built-in lens hood. Filter size is 72mm .....IMP. 769.95 /USA 919.95

#### **AF 135mm f/2D DC** (NI1352DAF)

Except for the longer focal length, this lens is identical to the AF 105mm f/2D. A standard telephoto lens, the AF 135mm f/2D also features Defocus-image Control, rounded diaphragm and rear focusing technology for fast AF operation. Built-in lens hood. Filter size is 72mm .....IMP. 899.95 /USA 1069.95

#### **AF 180mm f/2.8D ED-IF** (NI18028DEDAF)

High-performance telephoto lens for sports arenas, concert halls, photo journalism and astronomical photography. This lens uses ED glass elements to ensure high-resolution and high-contrast image even at maximum aperture. Internal Focusing technology for fast AF operation. Has a built-in lens hood. Includes CL-38 hard case. Filter size is 72mm.....IMP. 619.95 /USA 749.95





## AF NIKKOR LENSES

### TELEPHOTO LENSES

#### **AF-S VR Nikkor 200mm f/2.0G IF-ED (NI2002AF)**

Combining fast f/2.0 performance with the precision of 'Super ED' Glass and innovative Vibration Reduction (VR) technology, the AF-S VR Nikkor 200mm f/2G IF-ED lens offers photographers razor sharp images in the most demanding situations. It allows emphasis on subjects in portraits by rendering background elements completely out of focus, or use it for its large aperture, superb clarity and immense potential with VR technology for shooting in low light conditions or from moving platforms.

Super ED glass is a significant new material that is more resilient than typical fluorite lenses. While the optical properties of this new glass closely resemble those of fluorite, Super ED glass is more resilient to rapid temperature changes (thermal shock)—ensuring consistent performance even under extremely harsh shooting conditions. Super ED glass boasts a higher refractive index, making it highly capable of correcting aberrations other than chromatic aberration. Additionally, the unique composition of Super ED glass ensures consistency in optical properties and performance, enabling applications in a variety of lenses including those with very large apertures. The lens incorporates a host of convenient features that are placed within comfortable reach of photographers' natural grip, helping keep their eye on the subject. A switch on the bottom of the lens gives fast access to the AF-L function, which allows a desired focus position to be easily preset. The same switch can also be used to access the AF-ON function enabling more subjective focus with fine manual manipulation. The switch can also activate the lens to revert back to the preset focus position whenever desired. Includes HK-31 lens hood, 52mm drop-in filter holder with NC filter, and LN-1 lens strap.....IMP. 3799.95 /USA 3995.00



#### **AF-S VR Nikkor 300mm f/2.8G IF-ED**



The AF-S VR Nikkor 300mm f/2.8G IF-ED is a super-telephoto lens that features Nikon's remarkable Vibration Reduction (VR) technology to achieve sharper pictures in low light or shaky conditions than any other existing technology. Now sports and action photographers can reap the benefits of VR in a focal length they most often use. Coupled with the added advantage of Nikon's new Nano-Crystal AR coat, photographers can expect very sharp, high-contrast images from this lens.

The lens also offers handy access to a control pad on the side of the barrel for seamless usability. A Focus Mode switch enables instant and easy switching between M/A (Manual-Priority Autofocus) and M (Manual Focus) modes, while a Focus Limiter

switch restricts AF-servo movement within a selected shooting distance range. New Focus Preset buttons can instantly recall a preset focal point - a priceless feature when photographers shooting sports need to quickly return focus to a specific location such as a base or a team's goal.

The AF-S VR Nikkor 300mm f/2.8G IF-ED also benefits from Nikon's new Nano-Crystal AR Coat, which demonstrates superior anti-reflective properties to virtually eliminate ghost and flare to provide clear and vivid images when shooting under powerful sunlight or indoors under spotlights.

Other features include Nikon's exclusive SWM (Silent Wave Motor) that combines fast and accurate autofocusing with super-quiet operation, ED glass elements that minimize chromatic aberration, Internal Focusing (IF) for smoother focusing and a better balanced body, as well as a rubber ring on the lens mount that delivers the same level of resistance to dust and drops of water as Nikon's professional cameras such as the F6.

AF-S VR Nikkor 300mm f/2.8G IF-ED (NI30028DAFSB): Black color .....4399.95

AF-S VR Nikkor 300mm f/2.8G IF-ED (NI30028DAFSG): Light Gray color.....4399.95

USA= Imported & Warrantied by Nikon USA

IMP. = Imported & Warrantied by B&H (not qualified for Nikon USA rebates and warranties)

# NIKON

## AF NIKKOR LENSES

### SUPER TELEPHOTO LENSES

*Ideal for a wide range of picture taking, from sports, action and wildlife, to extraordinary tight-close-up portraits, to general landscape photography, these super telephoto lenses combine Nikon's superior optical quality with the legendary Nikon Silent Wave Motor for fast, quiet, and accurate autofocus. In addition, Nikon optical design including Extra Low Dispersion (ED) optical glass and Internal Focusing (IF) optical design compliments the smooth mechanical construction of these lenses.*



AF-S 500mm f/4D ED-IF II

- ◆ Exclusive Silent Wave Motor (SWM) makes autofocus operation virtually silent while providing extremely fast and accurate focus. Subjects literally “pop” into focus.
- ◆ Three high performance Extra Low Dispersion (ED) optical glass elements (the 300mm f/4 has two) eliminates secondary optical chromatic aberrations which are typical in ordinary telephoto optics.
- ◆ Internal Focusing (IF) allows a smaller and more compact design. Also enables auto and manually focus without lenses changing size or balance. Provides smooth and fast autofocus or responsive, finger-light manual focusing.
- ◆ 9-blade rounded aperture makes out-of-focus elements appear more natural while providing crisper details.
- ◆ Nikon D-type (Distance Signal Technology) design provides focus distance information to camera's metering systems. This enables the lenses to support Nikon's 3D Matrix Metering and flash operation and achieve precise exposure accuracy, anywhere.
- ◆ They accept Nikon's TC-14E II TC-17E II and TC20E II AF-S teleconverters.
- ◆ M/A Mode provides instant switching from autofocus to manual focus even during AF servo operation.
- ◆ Nikon Super Integrated Optical coating is applied to enhance image quality for crisper color rendition and reduced flare and ghosting.
- ◆ They offer a lightweight magnesium die-cast body with a tripod mounting foot for easy portability and handling. Lens hoods are supplied to minimize stray light.
- ◆ With Nikon's legendary F lens mount they are manual focus -compatible with every Nikon SLR made since 1959.
- ◆ Easy, smooth manual focusing operation; simulated leather finish for superior grip; filter attachment does not rotate during focusing; dust- and water drop-resistant.

#### **AF-S 300mm f/2.8D ED-IF II**

Close focusing in AF mode down to 7.5'. Includes CL-L1 reinforced ballistic nylon case for storage – even when attached to an SLR, HK-26 lens hood and 52mm rear ND filter. Weighs 5.6 lbs.

NI30028DAFSB Black .....4199.95  
NI30028DAFSG Light Gray.....4399.95

#### **AF-S 300mm f/4D ED-IF**

Close focusing to 4.8' gives photographers the ability to make dramatic portraits. Incredibly lightweight at 3.1 lbs. Built-in, retractable lens hood. Detachable tripod-mounting collar. 77mm filter size.

NI3004DAFS Black.....1099.95  
NI3004DAFSG Light Gray.....1159.95

#### **AF-S 400mm f/2.8D ED-IF II**

Close focusing to 11.8'. Weighs 9.8 lbs. Includes CT-402 Trunk Case, HK-25 Lens Hood and 52mm rear ND filter.

NI40028AFS2B Black.....7699.95  
NI40028AFS2G Light Gray.....7799.95



AF-S 300mm f/4D ED-IF

#### **AF-S 500mm f/4D ED-IF II**

Close focusing to 16'. Weighs 7.6 lbs. Includes Trunk Case, HK-24 Lens Hood and 52mm rear ND filter. A great lens for a sports or wildlife photographer

NI5004AFB Black.....7099.95  
NI5004AFG Light Gray.....7199.95

#### **AF-S 600mm f/4D ED-IF II**

The ultimate super telephoto lens for sports, distant fast-moving subjects and wildlife. Close focusing to 18.4'. Weighs 10.7 lbs. Includes CT-606 Trunk Case, HK-23 Lens Hood and 52mm rear ND filter. This second-generation AF-S lens features lighter weight and higher magnification.

NI6004AFB Black.....8999.95  
NI6004AFG Light Gray.....8999.95



**EQUIPMENT LEASING AVAILABLE**

# NIKON

## AF NIKKOR LENSES

| Lens                       | Lens Construction (groups/elements) | Picture Angle | Minimum f/stop | Filter Size | Lens Case     | Lens Hood | Weight   |
|----------------------------|-------------------------------------|---------------|----------------|-------------|---------------|-----------|----------|
| AF 14mm f/2.8D ED          | 14/12                               | 90°           | 22             | Provided    | Soft Case     | Built-in  | 23.6     |
| AF Fisheye 16mm f/2.8D     | 5/8                                 | 180°          | 22             | Provided    | CL-31S, CL-S2 | Built-in  | 10.1     |
| AF 18mm f/2.8D             | 10/13                               | 100°          | 22             | 77          | CL-47         | HB-8      | 13.6     |
| AF 20mm f/2.8D             | 9/12                                | 94°           | 22             | 62          | CL-30S, CL-S2 | HB-4      | 9.5      |
| AF 24mm f/2.8D             | 9/9                                 | 84°           | 22             | 52          | CL-30S, CL-S2 | HN-1      | 9.5      |
| AF 28mm f/1.4D             | 8/11                                | 74°           | 16             | 72          | CL-44, CL-S2  | HK-7      | 18.3     |
| AF 28mm f/2.8D             | 6/6                                 | 74°           | 16             | 52          | CL-30, CL-S2  | HN-2      | 7.3      |
| AF 35mm f/2D               | 5/6                                 | 62°           | 22             | 52          | CL-30S, CL-S2 | HN-3      | 7.2      |
| AF 50mm f/1.4D             | 6/7                                 | 46°           | 16             | 52          | CL-30S, CL-S2 | HR-2      | 7.9      |
| AF 50mm f/1.8              | 5/6                                 | 46°           | 22             | 52          | CL-30S, CL-S2 | HR-2      | 5.5      |
| AF 85mm f/1.4D IF          | 8/9                                 | 28° 30'       | 16             | 77          | CL-44, CL-S2  | HN-31     | 19.8     |
| AF 85mm f/1.8D             | 6/6                                 | 28° 30'       | 16             | 62          | CL-15S, CL-S2 | HN-23     | 13.2     |
| AF DC 105mm f/2D           | 6/6                                 | 23° 20'       | 16             | 72          | CL-38, CL-S2  | Built-in  | 21.9     |
| AF DC 135mm f/1.8D         | 6/7                                 | 18°           | 16             | 72          | CL-38, CL-S2  | Built-in  | 28.6     |
| AF 180mm f/2.8D ED-IF      | 6/8                                 | 13° 40'       | 22             | 72          | CL-38, CL-S2  | Built-in  | 27.2     |
| AF-S VR 200mm f/2G IF ED   | 9/13                                | 12° 20'       | 22             | 52          | CL-L1         | HK-31     | 6.4 lbs  |
| AF-S 300mm f/4D ED IF      | 6/8                                 | 8° 10'        | 32             | 82/39       | CL-42         | Built-in  | 46.9     |
| AF-S VR 300mm f/2.8G IF-ED | 8/11                                | 8° 10'        | 22             | 52          | TBA           | TBA       | 6.38 lbs |
| AF-S 300mm f/2.8D ED-IF II | 8/11                                | 8° 10'        | 22             | 52          | CT-305        | HK-26     | 105.8    |
| AF-S 400mm f/2.8D ED-IF    | 9/11                                | 6° 10'        | 22             | 52          | CT-402        | HK-27     | 169.3    |
| AF-S 500mm f/4D ED-IF      | 9/11                                | 5°            | 22             | 52          | CT-502        | HK-28     | 130.5    |
| AF-S 600mm f/4D ED-IF      | 7/10                                | 4° 10'        | 22             | 52          | CT-605        | HK-28     | 204.6    |

CAMERAS & LENSES

131

USA= Imported & Warrantied by Nikon USA  
 IMP. = Imported & Warrantied by B&H (not qualified for Nikon USA rebates and warranties)

### AF-S TELECONVERTER LENSES

Nikon's AF-S Teleconverters incorporate Nikon's Integrated Coating to reduce flare and ghosting as well as a cosmetic design that matches the latest AF-S Nikkor lenses. Designed for use with Nikon AF-S and AF-I Nikkor lenses, the TC-14EII (1.4x), TC-17EII (1.7x) and TC-20EII (2x) teleconverter lenses allow photographers to increase focal length without reducing optical quality and to retain a sense of overall comfort in the hand. The lenses offer full aperture metering with compatible cameras and also allow for autofocus when used with Nikon F6, F5, F100 and N80 AF SLR Cameras. In addition, the lenses come with a BF-3A front cap which can also be used as a body cap.



TC-14EII

#### **TC-14EII** **1.4x Teleconverter**

- Increases focal length by 1.4x
- Reduces lens aperture by one f-stop
- Supports the use of Nikon Vibration Reduction (VR) function

NITC14E2 .....IMP. 329.95 /USA 399.95

#### **TC-17EII 1.7x Teleconverter**

- Allows focal length to be extended by a factor of 1.7x while retaining a sense of overall comfort in the hand. Minimal effect on f-number of 1.5 stops
- Supports the use of Nikon Vibration Reduction (VR) function

NITC17E2 .....IMP. 339.95 /USA 409.95

#### **TC-20EII** **2x Teleconverter**

- Increases focal length by 100% - 2x
- Reduces lens aperture by two f-stops
- Supports the use of Nikon Vibration Reduction (VR) function

NITC20E2 .....IMP. 339.95 /USA 429.95

ORDER & INFO. (212) 502-6340 • FAX: (212) 239-7770 (800) 947-7008  
**1-800-290-6750 • www.bhphotovideo.com**



# NIKON

## AF NIKKOR LENSES

CAMERAS & LENSES

132

### SUPER WIDE ANGLE ZOOM LENSES



AF 18-35mm f/3.5-4.5D IF



AF 24-85mm f/2.8-4D IF

#### **AF-S 17-35mm f/2.8D ED-IF** (NI173528DAFS)

An ultra-wide-angle rectilinear zoom lens. Features ED glass and aspheric lens elements to provide superior optical performance and minimized chromatic aberration, even at close distances (0.9' through the entire zoom range). Internal Focusing (IF) design for smoother focusing, Silent Wave Motor for super-fast, super-quiet AF operation, and M/A mode for instant switching to manual focus even during AF operation by simply rotating the focus ring. Includes case and HB-23 lens hood. Filter size is 77mm.....IMP. 1349.95 /USA 1479.95

#### **AF 18-35mm f/3.5-4.5D** (NI183535DAF)

Compact ultra wide to wide angle lens with a focus distance of 1' to infinity—ideal for landscape, candid, close-up and full-length portrait photography. Features an internal focusing (IF) design, and an aspherical lens element to minimize distortion throughout the zoom range. Supplied HB-23 hood shields the lens against reflection from stray light. Filter size is 77mm .....IMP. 409.95 /USA 489.95

#### **24-85mm f/3.5-4.5G AF-S ED-IF** (NI248535GAFS)

Compact and lightweight, this high performance zoom lens captures 24mm wide angle images and provides close focusing throughout the focusing range. Ideal for landscapes, full length portraits, travel and general purpose photography. AF-S motor provides superior speed, silence and convenient operation. Includes HB-28 lens hood. Filter size is 67mm .....IMP. 309.95 /USA 349.95

#### **AF 24-85mm f/2.8-4D** (NI248528DAF)

Compact and lightweight, this high performance lens captures 24 mm images with a fast f/2.8 maximum aperture, making it ideal for available light shooting or slow/rear flash sync techniques. Maximum reproduction ratio from 35-85mm is 1:2 life-size allowing superb close-ups. Features Nikon Super Integrated optical coating, two aspherical lens elements (hybrid and molded-glass aspherical) and Internal Focusing design. Filter attachment does not rotate during focusing or zooming. Supplied with HB-25 flower-type lens shade. Filter size is 72mm .....IMP. 469.95 /USA 539.95

USA= Imported & Warrantied by Nikon USA

IMP. = Imported & Warrantied by B&H (not qualified for Nikon USA rebates and warranties)

### WIDE ANGLE ZOOM LENSES

#### **AF-S 28-70mm f/2.8D ED-IF** (NI287028AFS)

Equipped with all of Nikon's exclusive lens technologies, this is one of the world's highest performing lenses. Features include Silent Wave Motor (SWM), aspherical lens element, two ED glasses, 9-blade rounded aperture, M/A mode, Super Integrated Optical coating, Nikon D-type (Distance Signal Technology) and IF (Internal Focusing) design. Rotating zoom ring offers precise zoom control. Filter attachment does not rotate during focusing or zooming. Dedicated lens shade effectively shields against stray light. Has a dust and moisture-resistant design. Filter size is 77mm .....IMP. 1329.95 /USA 1429.95

#### **AF 28-80mm f/3.3-5.6G** (NI288033GAF)

Ultra-compact with a comfortable, well-balanced feel, this lens is ideal for travel landscapes, scenics and general family photography. Built-in aperture control via the Command Dial (found on the newest Nikon SLRs) allows the aperture ring to be left off, resulting in a more compact and lighter lens. Also features an aspherical lens element and Super Integrated Coating. A rounded diaphragm opening with seven blades, makes out-of-focus elements appear more natural. Filter size is 58mm .....IMP. 74.95 /USA 89.95

#### **AF 35-70mm f/2.8D** (NI357028DAF)

Excellent for general photography, this high-performance, high-speed zoom lens has a fast and constant f/2.8 maximum aperture. Distortion is controlled throughout the range. Push-pull type zoom is ideal for zoom effects during shooting. Filter size is 77mm .....IMP. 549.95 /USA 679.95



AF-S 28-70mm f/2.8D ED-IF



AF 28-80mm f/3.3-5.6G



**ONE HOUR FREE PARKING**  
AT 349 W. 34th STREET (with purchase of \$100 or more)

# NIKON

## AF NIKKOR LENSES

CAMERAS & LENSES

133

### HIGH-POWER ZOOM LENSES



AF 24-120mm f/3.5-5.6D IF, top  
AF 28-105mm f/3.5-4.5D, bottom



AF 28-100mm f/3.5-5.6 G

#### **AF 24-120mm f/3.5-5.6G ED-IF AF-S VR** (NI2412035GAF)

An incredibly compact and versatile 5X zoom lens the AF 24-120mm is ideal for travel, landscape, stock and portraiture photography as well as photo journalist applications. Hybrid and molded-glass aspherical lens elements for minimized distortion, higher resolution and excellent contrast. IF (Internal Focusing) design for fast AF operation. Filter size is 72mm .....IMP. 484.95 /USA 509.95

#### **AF 28-100mm f/3.5-5.6 G** (NI2810035GAF)

This all-around lens is ideal for travel, landscapes and even portraits. It features Super Integrated Coating to enhance color performance while minimizing flare, G technology to enable lens apertures to be selected directly from Nikon SLR camera, and Distance Technology which provides precision distance information from the lens. Filter size is 72mm.....IMP. 89.95 /USA 119.95

#### **AF 28-105mm f/3.5-4.5D IF**(NI2810535DAF)

A versatile 3.8X zoom lens, the AF 28-105mm creates sharp and beautiful images including close-ups (up to half life-size at 105mm), landscapes, portraits, fast action, nature and wildlife pictures. Hybrid-type aspherical lens element minimizes distortion and IF (Internal Focusing) technology for fast AF operation. Nine-blade rounded diaphragm opening makes out-of-focus elements appear more natural. Built-in lens hood. Filter size is 62mm .....IMP. 289.95 /USA 324.95

#### **AF 28-200mm f/3.5-5.6G ED-IF** (NI2820035GAF)

A flexible high-power 7x zoom lens, the AF 28-200 covers an amazing 28mm wide angle to 200mm telephoto range, incorporating eight popular focal lengths. Ideal for travel, landscapes, portraits, sports and much more. Compact and lightweight, it features IF (Internal Focusing) technology for fast AF operation, and aspherical elements for minimized distortion, higher resolution and excellent contrast. Includes HB-12 lens hood. Filter size is 72mm .....IMP. 269.95 /USA 299.95

### TELEPHOTO ZOOM LENSES

#### **AF 70-300mm f/4-5.6D ED** (NI703004DAF)

A powerful, yet compact and lightweight 4.3x tel zoom lens. It features a rotating zoom ring for precise zoom operation and ED glass for high resolution and high contrast even at maximum aperture. Supplied lens hood minimizes stray light. Filter size is 62mm .....IMP. 279.95 /USA 299.95



#### **AF 70-300mm f/4-5.6G** (NI7030045GAF)

The AF 70-300mm f/4-5.6G is a portable telephoto zoom lens with Nikon quality optics, high-performance Nikon Super Integrated Coating and a 9-blade rounded diaphragm opening, which makes out-of-focus elements appear more natural. It is also a "G-type" Nikon lens, meaning there are no aperture rings (the aperture is selected on the camera body). The result is a more compact lens with mistake free operation since the aperture does not need to be set to minimum. Filter size is 62mm .....IMP. 99.95 /USA 129.95

#### **AF 80-200mm f/2.8D** (NI8020028DAQ)

High-performance, high-speed telephoto zoom lens, the AF 80-200mm f2.8D is a superb choice for sports and nature photography. Features fast and constant f/2.8 maximum aperture, and three ED glass elements for high-resolution and high-contrast even at maximum aperture. Includes CL-43a lens case. Filter size is 77mm .....IMP. 799.95 /USA 899.95



ORDER & INFO. (212) 502-6340 • FAX: (212) 239-7770 (800) 947-7008  
1-800-290-6750 • www.bhphotovideo.com



# NIKON

## AF NIKKOR LENSES

### VR TELEPHOTO ZOOM LENSES

#### **AF-S VR Zoom-Nikkor 70-200mm f/2.8G IF-ED**

The AF-S VR Zoom-Nikkor 70-200mm f/2.8G IF-ED lens is designed with professional and advanced amateur photographers in mind, offering them a truly compact and lightweight telephoto zoom lens featuring some of Nikon's most innovative technologies. With Nikon's advanced Vibration Reduction technology, the lens enables photographers to make crisp, sharp pictures by minimizing the blur caused by hand holding a camera at slow shutter speeds and by potential shaking when shooting from a moving vehicle, aircraft or any other moving platform that induces vibration. Other features include Manual Automatic mode (M/A) which allows for instant switching between auto and manual focus, virtually eliminating lag time in the transition and enabling photographers to make a last minute adjustment, even if the autofocus system has locked onto the subject. This performance is complimented by Nikon's AF Tracking with Lock-on, a technology that enables the system to maintain sharp focus even if the subject is momentarily obscured from view, or if the camera's AF sensor momentarily moves off the main subject. Includes HB-29 lens hood and CL-M2 case. Filter size is 77mm.



- ◆ Incorporates Extra Low Dispersion (ED) optical glass enabling superior performance from this versatile, compact lens. Through low dispersion characteristics the lens' color performance is enhanced by virtually eliminated secondary chromatic aberrations that are common to telephoto optics that don't have ED glass; this technology enhances image quality with added visible sharpness and contrast to the image.
- ◆ Nikon's exclusive Silent Wave Motor technology provides silent and fast autofocus with superior accuracy and ultra-quiet operation.

- ◆ Designed for Nikon cameras with a built in Sub-Command Dial, G-type design allows aperture control exclusively from the camera. This facilitates better lens handling, and lets you keep a more positive grip on the camera as you use your right index finger to adjust aperture.
- ◆ Distance Technology provides precision distance information from the lens which is then incorporated into exposure calculations for both ambient light and flash illumination, as well as combinations of both. This leads to improved exposure control and enhances the Nikon system for automatic balanced fill flash.

NI7020028AFS Black.....IMP. 1449.95 /USA 1599.95

NI7020028AFQ Light Gray .....IMP. 1469.95 /USA 1649.95

#### **AF VR 80-400mm f/4.5-5.6 D ED (NI8040045AF)**

Now photographers who shoot hand-held, especially in low light conditions can count on dramatically sharper pictures. Equipped with Nikon's Vibration Reduction (VR) technology and superior optical design, the AF VR 80-400mm delivers sharp images in otherwise impossible situations. Extending hand-held picture-taking into the realm of photography that usually requires a cumbersome tripod, sports and nature photographers can concentrate on capturing the hoop shot of the century or the flight of a rare bird knowing that even if their hand is not steady, the images will be sharper and truer. Includes HB-24 lens hood and CL-M1 case. Filter size is 77mm.



- ◆ Proprietary VR system detects and compensates for image blur caused by camera shake. When activated, the system allows photographers to shoot with ambient light at shutter speeds that are slower by up to about 3 stops, when compared to the restrictions of shooting without vibration reduction.
- ◆ The VR system uses angular speed sensors that detect minute shifts in camera movement. Data from the sensors is used to calculate the change in position and drive voice coil motors to shift the position of the VR lens element.

- ◆ Automatically detects shake that takes place during panning in any direction. And there is no need to stop and reset the lens for panning action; it happens automatically.
- ◆ Three ED glass elements reduce secondary chromatic aberrations and help the lens provide significantly sharper pictures throughout the 80-400mm zoom range.
- ◆ Also features Nikon's Super Integrated Coating, a nine-blade diaphragm for rounder more natural highlights, and A/M switch for fast switching from auto to manual focus.

AF VR 80-400mm f/4.5-5.6 D ED (NI8040045AF).....IMP. 1229.95 /USA 1429.95



For Any Inquiries Regarding Your Order, Call Our Customer Service:  
(800) 221-5743 • (212) 239-7765 • FAX: (800) 947-2215 • (212) 239-7549

## AF NIKKOR LENS SPECIFICATIONS

| Lens                                | Lens Construction<br>(elements/groups) | Picture<br>Angle | Minimum<br>f/stop | Filter<br>Size | Lens<br>Case  | Lens<br>Hood | Weight   |
|-------------------------------------|--|------------------|-------------------|----------------|---------------|--------------|----------|
| <b>Zoom</b>                         |  |                  |                   |                |               |              |          |
| AF-S 17-35mm f/2.8D                 | 13/10                                  | 104°-62°         | 22                | 77             | CL-76         | HB-23        | 26.3     |
| AF 18-35 f/3.5-4.5D                 | 11/8                                   | 100°-62°         | 22                | 77             | CL-S2         | HB-23        | 13       |
| AF 24-85mm f/2.8-4D                 | 15/11                                  | 84°-28° 30'      | 22                | 72             | CL-S2         | HB-25        | 19.2     |
| AF 24-85mm f/3.5-5.6G ED-IF         | 12/15                                  | 84°-28° 30'      | 22                | 67             | -             | HB-28        | 14.3     |
| AF 24-120mm f/3.5-5.6D IF           | 11/15                                  | 80°-20° 30'      | 22                | 72             | CL-49, CL-S2  | HB-11        | 19.6     |
| AF-S 28-70mm f/2.8D                 | 15/11                                  | 74°-34° 20'      | 22                | 77             | CL-74         | HB-19        | 33       |
| AF 28-80mm f/3.3-5.6G               | 7/7                                    | 74°-30° 10'      | 22                | 58             | CL-32S, CL-S2 | HB-10        | 7.8      |
| AF 28-105mm f/3.5-4.5D              | 16/12                                  | 74°-23° 20'      | 22                | 62             | CL-49         | HB-18        | 16       |
| AF 28-200mm f/3.5-5.6D IF           | 13/16                                  | 74°-12° 20'      | 22                | 72             | CL-49, CL-S2  | HB-12        | 19.6     |
| AF 35-70mm f/2.8D                   | 12/15                                  | 62°-34° 20'      | 22                | 62             | CL-33S, CL-S2 | HB-1         | 23.8     |
| AF-S VR 70-200mm f/2.8G IF- ED      | 15/21                                  | 34° 20'          | 22                | 77             | CL-M2         | HB-29        | 51.1 oz. |
| AF 70-300mm f/4-5.6D ED             | 9/13                                   | 34° 20'-8° 10'   | 32                | 62             | CL-72, CL-S2  | HB-15        | 18.2     |
| AF 70-300mm f/4-5.6G                | 9/13                                   | 34° 20'-8° 10'   | 32                | 62             | CL-S4         | HB-26        | 18.1     |
| AF-S 80-200mm f/2.8D ED             | 18/14                                  | 30° 10'-12° 20'  | 22                | 77             | CL-73         | HB-17        | 51.1     |
| <b>Special Purpose</b>              |  |                  |                   |                |               |              |          |
| AF Micro 60mm f/2.8D                | 7/8                                    | 39° 40'          | 32                | 62             | CL-32S, CL-S2 | HN-22        | 16.0     |
| AF Micro 105mm f/2.8D               | 8/9                                    | 23° 20'          | 32                | 52             | CL-15S, CL-S2 | HS-7         | 19.6     |
| AF Micro 200mm f/4D ED IF           | 8/13                                   | 12° 20'          | 32                | 62             | CL-45         | HN-30        | 42.3     |
| AF Micro 80-400mm f/4.5-5.6D ED VR  | 17/11                                  | 30°-6° 10'       | 32                | 77             | CL-M1         | HB-24        | 47       |
| AF Micro 200-400mm f/4.5-5.6D ED VR | 24/17                                  |                  | 22                | 52 Rear        | CL-L2         | HK-30        | 7 lbs.   |

### 200-400mm f/4G IF-ED AF-S VR Zoom-Nikkor

Combines four fixed focal length super-telephoto lenses into a single compact super-telephoto AF Zoom Nikkor lens. The world's first AF-S VR super-telephoto 200-400mm zoom lens, it automatically detects when a photographer is panning and compensates. Has two VR modes: Normal mode or Active Mode for when taking pictures with extreme movement. VR operation offers the equivalent of using a shutter speed 3 stops faster.

It also features an exclusive Silent Wave Motor enabling ultra-high-speed autofocus with exceptional accuracy and powerful super-quiet operation. 4 Extra-Low Dispersion (ED) glass elements minimizes chromatic aberration and provides higher resolution and superior contrast. Internal Focusing (IF) design for smoother focusing and great body balance.

M/A mode enables instant switching from autofocus to manual with virtually no time lag even during AF servo operation



- Compatible with AF-S TC14E (II), TC17E (II) and TC20E (II) teleconverters
- Minimum focus distance of 6.2' at all focal lengths
- No power consumption during manual focus operation
- Rounded diaphragm (9 blades) for natural blur

- Includes detachable tripod mounting collar
- G design enables apertures to be selected from select camera bodies
- Nikon D-type design provides precise distance information for flash and ambient light exposure processes
- Fully Compatible with F6, F5, F100, N80, N75 and N65 cameras

200-400mm f/4G IF-ED AF-S VR Zoom-Nikkor (NI2004004GAF) .....IMP. 4999.90 /USA 5099.95

**Nikon USA lenses include 1-Year Nikon USA Warranty, plus 4-years extended service coverage. Many lenses also include rebates up to \$400. Please go on-line or call us for details and expiration dates.**

# NIKON

## NIKON LENS ACCESSORIES

### Lens Hoods

A lens hood is an integral part of your Nikon system. By reducing stray light and minimizing flare, your pictures show improved contrast and better color saturation. Hoods also provide important shock protection, should your lens be dropped or bumped. Hoods are available in four types:



HN-12 Hood

**Screw-On Hoods:** Screws onto the front of the lens. Metal type is available for extra strength. Rubber type folds back over the lens when not in use.

**Slip-On Hoods:** Slips over the front of the lens. Tightened with knurled screw and retainer ring. Use with wide-zoom and ultra-wide lenses.

**Snap-On Hoods:** Snaps onto the front of the lens with a spring-type retainer ring. The mounting can be conveniently reversed for storage.

**Bayonet Hoods:** Twist-lock mounting for extra security.

### Lens Caps

- LC-52 (NILC52)  
52mm snap-on front lens cap.....9.95
- LC-58 (NILC58)  
58mm snap-on front lens cap.....13.50
- LC-62 (NILC62)  
62mm snap-on front lens cap.....10.95
- LC-72 (NILC72)  
72mm snap-on front lens cap.....13.50
- LC-77 (NILC77)  
77mm snap-on front lens cap.....17.95
- BF-1A (NIBF1A)  
Lens mount cap for SLR cameras.....7.95
- LF-1 (NILF1)  
Rear lens cap for All F-mount lenses.....8.95

### Nikon Neck Straps

- AN-1 (NIAN1): Leather .....14.95
- AN-4B (NIAN4B): Black nylon .....14.95
- AN-4Y (NIAN4Y): Yellow nylon .....14.95
- NS-5 (NINS5): Soft wide .....14.95
- AN-6Y (NIAN6Y): Yellow nylon wide .....25.95

### LENS HOODS

| Type            | Hood  | B&H #  | Attachable Lenses  | Price  |
|-----------------|-------|--------|--|--------|
| Snap-On         | HS-7  | NIHS7  | 105mm f/2.8 Micro AF   | 23.95  |
| Snap-On         | HS-9  | NIHS9  | 50mm f/1.4 AIS   | 23.95  |
| Snap-On         | HS-11 | NIHS11 | 50mm f/1.8 AIS   | 23.95  |
| Snap-On         | HS-12 | NIHS12 | 50mm f/1.2 AIS   | 24.95  |
| Rubber Screw-On | HR-1  | NIHR1  | 50mm f/1.4 AIS, 70-210mm f/4.5-5.6 AIS                                     | 12.95  |
| Rubber Screw-On | HR-2  | NIHR2  | 50mm f/1.2 and f/1.8 AIS, 50mm f/1.4 and 1.8 D-AF                          | 12.95  |
| Screw-On        | HN-1  | NIHN1  | 24mm f/2.8 and 28 f/2 AIS  | 14.95  |
| Screw-On        | HN-2  | NIHN2  | AF 28mm f/2.8D   | 14.95  |
| Screw-On        | HN-3  | NIHN3  | 35mm f/1.4, AF 35mm f/2  | 14.95  |
| Screw-On        | HN-9  | NIHN9  | PC 28mm f/3.5  | 14.95  |
| Screw-On        | HN-12 | NIHN12 | 52mm Circular Polarizer  | 24.95  |
| Screw-On        | HN-13 | NIHN13 | 72mm Circular Polarizer  | 29.95  |
| Screw-On        | HN-20 | NIHN20 | 85mm f/1.4 (Replacement)   | 27.50  |
| Screw-On        | HN-22 | NIHN22 | AF 60mm f/2.8D Micro   | 21.95  |
| Screw-On        | HN-23 | NIHN23 | 85mm f/1.8 D-AF  | 21.95  |
| Screw-On        | HN-26 | NIHN26 | 62mm Circular Polarizer  | 29.95  |
| Screw-On        | HN-28 | NIHN28 | 80-200mm f/2.8 ED D-AF   | 29.95  |
| Screw-On        | HN-30 | NIHN30 | 200mm f/4.0 D-AF Micro   | 39.95  |
| Screw-On        | HN-31 | NIHN31 | 85mm f/1.4 D-AF (Replacement)  | 39.50  |
| Screw-On        | HN-34 | NIHN34 | 77mm Polarizer   | 29.95  |
| Screw-On        | HN-35 | NIHN35 | 45mm f/2.8P Nikkor (Replacement)   | 29.95  |
| Slip-On         | HK-2  | NIHK2  | 24mm f/2   | 24.95  |
| Slip-On         | HK-7  | NIHK7  | 28mm f/1.4D  | 52.50  |
| Slip-On         | HK-26 | NIHK26 | AF-S 300mm f/2.8D ED-IF II (Replacement)                                   | 279.95 |
| Slip-On         | HK-27 | NIHK27 | AF-S 400mm f/2.8D ED-IF II (Replacement)                                   | 359.95 |
| Slip-On         | HK-28 | NIHK28 | AF-S 500mm f/4D ED-IF II (Replacement)                                     | 299.95 |
| Slip-On         | HK-29 | NIHK29 | AF-S 600mm f/4D ED-IF II (Replacement)                                     | 579.95 |
| Slip-On         | HK-30 | NIHK30 | AF-S VR 200-400mm f/4G ED-IF (Replacement)                                 | 279.95 |
| Bayonet         | HB-1  | NIHB1  | AF 35-70mm f/2.8D  | 16.95  |
| Bayonet         | HB-4  | NIHB4  | AF 20mm f/2.8D   | 16.95  |
| Bayonet         | HB-7  | NIHB7  | AF 80-200mm f/2.8D   | 29.95  |
| Bayonet         | HB-15 | NIHB15 | AF 70-300mm f/4-5.6D ED (Replacement)                                      | 17.95  |
| Bayonet         | HB-18 | NIHB18 | AF 28-105mm f/3.5-4.5D   | 18.95  |
| Bayonet         | HB-20 | NIHB20 | 28-80mm f/3.3-5.6G   | 11.95  |
| Bayonet         | HB-22 | NIHB22 | 85mm f/2.8 PC Micro  | 39.95  |
| Bayonet         | HB-23 | NIHB23 | 17-35mm f/2.8 D AF-S and 18-35mm f/3.5-4.5 D-AF (Replacement)              | 15.95  |
| Bayonet         | HB-25 | NIHB25 | 24-85mm f/2.8-4.0 D-AF and 24-120mm f/3.5-5.6G ED-IF AF-S VR (Replacement) | 14.95  |
| Bayonet         | HB-26 | NIHB26 | 70-300mm f/4.0-5.6 G-AF (Replacement)                                      | 14.95  |
| Bayonet         | HB-27 | NIHB27 | 28-100mm f/3.5-5.6 G-AF  | 12.95  |
| Bayonet         | HB-28 | NIHB28 | 24-85mm f/3.5-4.5 G-AFS (Replacement)                                      | 14.95  |
| Bayonet         | HB-29 | NIHB29 | 70-200mm f/2.8 G-AFS (Replacement)   | 29.95  |
| Bayonet         | HB-30 | NIHB30 | 28-200mm f/3.5-5.6 G-AF (Replacement)                                      | 9.95   |



For Any Inquiries Regarding Your Order, Call Our Customer Service:  
(800) 221-5743 • (212) 239-7765 • FAX: (800) 947-2215 • (212) 239-7549



# NIKON

## NIKON LENS ACCESSORIES



### Filters for Color and B&W

Circular Polarizers darken the sky without affecting color balance, cut glare from water and metallic surfaces, and allow shooting through glass. Their mounts can be rotated for different angles which you can monitor through the viewfinder. (Note: they require a filter hood.) Conversion Filters match film color balances. For example, the A12 shifts the color balance of tungsten

film to daylight. B2 and B8 counteract existing light that is too warm. B12 matches artificial light to that of daylight film. Yellow filters absorb both blue and UV light so skies appear darker. Use them to clear up haze around distant objects. Stronger than yellow, Orange tones down blue and green. It heightens contrast between sky and objects and darkens foliage. Red filters out all colors except red, so blue skies appear almost black and green leaves darker. Green absorbs red and blue, letting green and yellow through. The X0 is for general-purpose use. The X1 gives skin a more natural tone.

### NIKON FILTERS

| Filter Type              | Desc. | 39mm              | 52mm              | 58mm            | 62mm              | 72mm              | 77mm              | 82mm              |
|--------------------------|-------|-------------------|-------------------|-----------------|-------------------|-------------------|-------------------|-------------------|
| Clear/<br>No Tint        | NC    | NINC39<br>26.50   | NINC52<br>31.95   | NINC58<br>33.95 | NINC62<br>44.95   | NINC72<br>79.95   | NINC77<br>89.95   |                   |
| Skylight                 | L1BC  | NIL1BC39<br>24.95 | NIL1BC52<br>25.95 |                 | NIL1BC62<br>38.95 | NIL1BC72<br>57.95 |                   |                   |
| Ultraviolet              | L37C  | NIL37C39<br>23.95 | NIL37C52<br>23.95 |                 | NIL37C62<br>33.95 | NIL37C72<br>54.95 | NIL37C77<br>62.95 | NIL37C82<br>74.95 |
| Yellow<br>Light          | Y44   |                   | NIY4452<br>23.95  |                 |                   |                   |                   |                   |
| Yellow<br>Medium         | Y48   | NIY4839<br>24.95  | NIY4852<br>23.95  |                 | NIY4862<br>34.95  | NIY4872<br>44.95  | NIY4877<br>59.95  |                   |
| Yellow<br>Dark           | Y52   | NIY5239<br>24.95  |                   |                 |                   |                   |                   |                   |
| Orange                   | O56   | NIO5639<br>24.95  | NIO5652<br>23.95  |                 | NIO5662<br>34.95  | NIO5672<br>44.95  | NIO5677<br>59.95  |                   |
| Red                      | R60   | NIR6039<br>24.95  | NIR6052<br>23.95  |                 | NIR6062<br>34.95  | NIR6072<br>44.95  | NIR6077<br>59.95  |                   |
| Green<br>Light           | X0    |                   | NIX052<br>23.95   |                 |                   |                   |                   |                   |
| Green<br>Dark            | X1    |                   | NIX152<br>23.95   |                 |                   |                   |                   |                   |
| Circular<br>Polarizer II | CP    |                   | NICP52<br>64.95   | NICP58<br>Call  | NICP62Q<br>84.95  | NICP72<br>109.95  | NICP77<br>139.95  |                   |
| Neutral<br>Density       | ND2s  | NIND2S39<br>32.95 |                   |                 |                   |                   |                   |                   |
| Neutral<br>Density       | ND4s  | NIND4S39<br>32.95 | NIND4S52<br>24.95 |                 |                   |                   |                   |                   |
| Neutral<br>Density       | ND8s  | NIND8S39<br>32.95 | NIND8S52<br>24.95 |                 |                   |                   |                   |                   |
| Amber<br>Light           | A2    | NIA239<br>24.95   | NIA252<br>23.95   |                 | NIA262<br>34.95   | NIA272<br>44.95   | NIA277<br>59.95   |                   |
| Amber<br>Dark            | A12   | NIA1239<br>24.95  | NIA1252<br>23.95  |                 | NIA1262<br>34.95  |                   |                   |                   |
| Blue<br>Light            | B2    | NIB239<br>24.95   | NIB252<br>23.95   |                 | NIB262<br>34.95   | NIB272<br>44.95   | NIB277<br>59.95   |                   |
| Blue<br>Medium           | B8    | NIB839<br>24.95   | NIB852<br>23.95   |                 |                   |                   |                   |                   |
| Blue<br>Dark             | B12   | NIB1239<br>24.95  | NIB1252<br>23.95  |                 | NIB1262<br>34.95  |                   |                   |                   |
| Soft Focus<br>No. 1      |       |                   | NISF152<br>56.95  |                 | NISF162<br>79.95  | NISF172<br>99.95  | NISF177<br>Call   |                   |
| Soft Focus<br>No. 2      |       |                   | NISF252<br>56.95  |                 | NISF262<br>79.95  | NISF272<br>99.95  |                   |                   |

### Lens Cases

#### Cylindrical Cases:

Tough black leatherette finish combined with soft, plush lining to protect your lenses, shielding them from shocks and bumps.

**CL-13A (NICL13A):** For 35-200/3.5-4.5 and 200/4 AIS lenses .....16.95

**CL-15S (NICL15S):** For 35/2, 85/1.8D, and AF 105/2.8 lenses .....34.95

**CL-30S (NICL30S):** For 20/2.8, 24/2.8, 28/2.8, 35/2D, 50/1.4 and 50/1.8 lenses .....26.95

**CL-31S (NICL31S):** For 16/2.8D, 24/2, 28/2, 35/1.4, 35/2.0, 50/1.2 and 85/1.8 lenses...26.95

**CL-32S (NICL32S):** For 24-50/3.3-4.5, 55/2.8, 60/2.8, 105/2.5 and 135/2.8 lenses .....32.95

**CL-33S (NICL33S):** For 28-85/3.5-4.5, 35-70/2.8 and 55/2.8 lenses .....32.95

**CL-34 (NICL34):** For 85/1.4 AIS lens .....26.95

**CL-36 (NICL36):** For 200/4 AIS lens .....49.95

**CL-38 (NICL38):** For 105/2D DC and 135/2D DC lenses.....34.95

**CL-44 (NICL44):** For 28/1.4D and AF 85/1.4D lenses .....49.95

**CL-47 (NICL47):** For 18mm f/2.8 lens .....59.95

**CL-49 (NICL49):** For 28-105/3.5-4.5D and AF 28-200/3.5-5.6 lenses .....47.95

**CL-71 (NICL71):** For 70-180/4.5-5.6 ED ..74.95

**CL-72 (NICL72):** For 70-300/4-5.6 lens ....44.95

#### Soft Pouches:

Accommodates different lenses with different focal lengths; put it away in a pocket when you're not using it.

**CL-S2 (NICLS2):** For the 14mm f/2.8, 18-35/3.5-4.5, 24-85/3.5-4.5G, 24-85/2.8 D-AF, 24-120/3.5-5.6G and 28-200/3.5-5.6G lenses .....29.95

**CL-S4 (NICLS4):** For the 70-300mm f/4.0-5.6 G-AF lenses .....29.95

**CL-L2 (NICLL2):** For the 400, 500 600mm and 70-200mm VR lenses .....129.95

**CL-M2 (NICLM2):** For the 300/4D AF-S and 70-200/2.8 lenses.....49.95

# PENTAX

## ZX-M

### **Manual Focus 35mm SLR Camera**

*Like its sister models in the popular ZX-series, the ZX-M offers super-compact dimensions and straightforward, easy to read dial controls; but focus is totally manual. It incorporates an array of creative and user-friendly features, including a multi-mode exposure system; an advanced light metering system; and a 1/2000-second high-speed shutter. For convenience, it offers easy film handling, LCD and viewfinder displays, depth-of-field preview and a Memory Lock function. As a result, this is the model for the next generation of photographers as well as those who want to learn the basic skills through creativity and fun. The ZX-M helps teach photography in a simple and easy way. It is also very lightweight, so just about anybody can take it just about anywhere. Accepts all A, FA, and F-mount lenses.*



#### **FEATURES**

##### **Compact, Lightweight Body**

The ZX-M measures just 135mm (5.3") wide, 90.5mm (3.6") high and 55mm (2.2") deep, and weighs only 305 grams (10.8 oz.), making it compact enough for the user to bring along on every occasion.

##### **Multi-Mode Exposure System**

The ZX-M offers four different exposure modes: the hands-off Programmed AE, the depth-oriented Aperture-Priority AE, the action oriented Shutter-Priority AE, and the totally maneuverable Metered Manual. The selection of an exposure mode is made simply by adjusting the lens aperture ring and/or the camera's shutter dial.

##### **Multi-Pattern Metering System**

The ZX-M multi-pattern metering system is designed to get the maximum performance from the camera's auto-exposure modes – even in difficult backlighting and high-contrast situations.

##### **Manual ISO Film Setting**

Film speed can be manually adjusted between ISO 6 and ISO 6400 in 1/3 steps, so that the photographer can set the right film speed for non-DX coded film or intentionally shift the exposure level on an entire roll of film.

##### **Exposure Compensation**

With a simple turn of the exposure compensation dial, this function allows the user to adjust the level of exposure within a  $\pm 3EV$  range in 1/2EV steps for bracketing or for intentional over - or underexposure.

##### **Memory Lock**

This function allows the user to ensure correct exposure on a single element in the final image by memorizing the exposure data for 10 seconds with simple push-button operation.

##### **LCD and Viewfinder Display**

The external LCD panel and viewfinder display offer a range of useful photographic data to the photographer at a glance. The viewfinder also features a Pentax original Natural-Bright-Matte focusing screen for a sharp, clear viewfinder image and an automatic illuminator for easy reading of data regardless of the subject's lighting condition.

##### **Easy Film Handling**

The built-in film winder loads the film, advances it to the first frame, winds it at the speed of two frames per second, and rewinds the film at the end of the roll – all automatically.

##### **High-Speed Shutter**

With a top shutter speed of 1/2000 second, the ZX-M can freeze a critical moment in the subject's movement. Such high shutter speeds are very useful in sports and action photography.

##### **Depth-of-field Preview**

One push of the preview button allows the user to check the depth of focus to create the desired visual effect, even when the lens aperture ring is set to the "A" (auto) position.

##### **Self-Timer**

The built-in self-timer delays shutter release by 12 seconds, allowing the photographer to be part of the picture. This is also useful for avoiding camera shake in slow-shutter and bulb applications.

##### **Compatibility with Pentax Lenses and Accessories**

Most existing high-quality Pentax 35mm interchangeable lenses and a wider range of optional accessories can be used with the ZX-M to satisfy the photographer's every creative need. (Note that autofocus operation is not available with the ZX-M even when a Pentax-FA lens is mounted.)



### Specifications

- Type: TTL automatic exposure multi-mode 35mm SLR
- Lens Mount: Pentax KA2 bayonet mount compatible with KAF2 KAF and K mounts
- Focus Modes: Manual
- Exposure Modes: Program AE, Aperture priority, Shutter priority & Manual
- Exposure Metering: 2-Zone evaluative metering with FA, F and A lenses; Centerweighted metering with all other lenses
- Metering Range: EV 1-21 @ ISO 100 with f/1.4 Lens
- Shutter Speed: 1/2000th to 30 Seconds + B, with sync at 1/100th second
- Exposure Compensation: ± 3 EV in 0.5 EV increments
- ISO Range: 25-5000 ( DX ), 6-6400 in Manual setting
- Film Wind: single and continuous up to 2 frames per second
- Focusing Screen: Fixed overall matte with split image & microprism
- Diopter Correction: Standard -1 (other "M" diopters available optionally )
- Self Timer: 12-Second delay
- Remote Control: Optional Cable Switch F
- Depth-of-Field Preview: Yes
- Power: Two CR2 3v lithium batteries
- Measures 5.3 x 3.6 x 2.2" WxHxD, weighs 0.67 lb.

- ZX-M Silver Body (PEZXM):**  
Includes strap and FH Eyecup...**159.95**
- FH Eyecup (PEECFH):**  
Replacement ..... **17.95**
- FG Hot Shoe Cover (PEHSCFG).....6.95**
- FK Front Case (L) (PECFLZX):**  
For ZX-M with up to 80-200mm f/4.7-5.6 lens .....**34.95**
- FK Front Case (M) (PECFMZ):**  
For ZX-M with up to a 35-105mm lens ..... **32.95**
- FK Front Case (S) (PECFSZX):**  
For ZX-M with up to a 35-80mm lens ..... **29.95**

### MANUAL FOCUS LENSES

#### **SMCP-A 50mm f/1.2** **Manual Focus Lens (PE5012)**

Pentax was the first to introduce a f/1.2 lens in the 50mm focal length. This new version has unsurpassed contrast and resolution for a lens of this aperture. Filter size is 52mm.....**659.95**



SMCP-A 50mm f/2.0

#### **SMCP-A 50mm f/2.0** **Manual Focus Lens (PE502)**

This is an excellent normal lens with high sharpness and contrast. A great first lens for students, and a must-have in any one's collection of optics. Filter size is 49mm.....**59.95**



SMCP-A 80-200mm f/4.7-5.6

#### **SMCP-A 35-80mm f/4.0-5.6** **Manual Focus (PE35804)**

A lightweight zoom lens for Pentax manual focus cameras, the 35-80mm f/4.0-5.6 is compact and easy to use. Filter size is 49mm ...**69.95**

#### **SMCP-A 80-200mm f/4.7-5.6** **Manual Focus (PE8020047)**

An all-manual telephoto zoom lens for Pentax and other K-mount cameras that's lightweight and doesn't need a tripod collar despite the focal length. Filters are inexpensive thanks to the 49mm thread size .....**119.95**

### Hove / Magic Lantern Book:

#### **Magic Lantern Guide For Pentax K1000 and ZX-M Cameras by Joseph Meehan (HOMSLR)**

Fully illustrated in color and black and white, the book offers step-by-step instructions in an easy-to-understand format that helps you learn how to use the camera's many capabilities and take better pictures. This guide is especially helpful for learning how to use your camera's manual settings and offers details about the cameras' features and functions. Topics covered are: controlling exposure, selecting lenses and lens accessories, using filters, and using flash. Magic Lantern Guides have sewn bindings and laminated covers for long life. 5 x 7 1/2", 176 pages.....**19.95**



#### **FJ Data Back (PEDBFJQ)**

The FJ Data Back replaces the existing camera door on the ZX-M camera and allows you to imprint the date or time on your pictures, with a choice of five different modes, in the lower right corner of the picture .....**39.95**

# PENTAX

## \*IST DATE

### 35mm Autofocus SLR with Date

Offering superior 35mm SLR performance with compact dimensions and easy operation and display systems, the Pentax \*ist easily satisfies a wide range of photographers from demanding professionals and advanced amateurs to SLR novices. The Pentax \*ist Date SLR incorporates a host of advanced, user-friendly features for easy operation and more creative results. Features include a multi-mode exposure system with an innovative Auto Picture mode and an accessible illumination mode dial, a 16-segment multi-pattern metering system, an 11-point Auto Focus system, a 1/4000-second high-speed shutter, 17 custom functions, a large LCD panel, a multi-data LCD viewfinder indicator, and a retractable auto pop-up flash. The \*ist Date also accepts a full range of high-quality Pentax lenses and accessories, like the BG-20 battery grip to maximize the fun and excitement of advanced SLR photography.



### FEATURES

#### Ultra Compact

- ◆ Ultra-compact with a functional design, the \*ist Date measures 4.8 x 3.3 x 2.5" and weighs 11.8 oz. All controls are positioned for easy operation and accessibility.

#### Sophisticated Auto Focus

- ◆ An advanced SAFOX VIII phase-matching AF system assures that the \*ist delivers crisp focus even under poor lighting conditions.
- ◆ An 11-point AF sensor constantly monitors 11 different points in the image field and covers a wide area — both vertically and horizontally — to ensure optimum focus.
- ◆ In addition to the "AUTO" mode where the camera selects the optimum focusing point and "SPOT" mode, you can select one of 11 AF sensor points using the cross-shaped AF point selector on the back panel.
- ◆ Predictive Auto Focus function automatically activates when the system detects subject motion and predicts the subject position at the moment of shutter release. This also lets you shoot a few frames after the subject has moved out of the AF sensor field.

#### Three Metering System

- ◆ A 16-segment multi-pattern metering system helps solve the most complicated lighting conditions to produce beautifully exposed photographs. In addition to an all-purpose multi-pattern mode, the \*ist offers spot and center-weighted modes for specialized applications.

#### Auto Picture Mode

- ◆ In Auto Picture Mode, the \*ist Date selects the appropriate auto-exposure mode from five different programs, based on the subject's distance, focal length, lighting and subject motion. This ensures better results and allows you to concentrate fully on shutter opportunity and picture-framing.
- ◆ For added convenience, the large illumination mode dial clearly indicates the selected exposure program, even in the dark. The selected program also is indicated in the viewfinder indicator.
- ◆ In addition to Auto Picture Mode, there are six user-selectable Picture Modes, Aperture and Shutter-Priority, manual and bulb.

#### Flash System

- ◆ Built-in multi-function retractable auto flash with auto pop-up feature. Covering an angle of view as wide as 28mm, the auto flash automatically pops up and discharges when the camera detects low-light and/or backlight situations. It also retracts to the storage position automatically when the power is off. Employs red-eye reduction function as well.
- ◆ Advanced TTL flash control system simplifies complicated flash techniques (such as daylight sync, slow-shutter sync and bulb sync) even when used in combination with accessory flashes. When combined with the AF360FGZ, the \*ist offers a variety of advanced wireless remote functions. In addition, it briefly discharges in the dark to assist the camera's AF system.



#### High Speed Shutter

- ◆ The compact, reliable shutter unit offers a top shutter speed of 1/4000 second to freeze the decisive moment of fast-action scenes and features a high flash synchronization speed of 1/125 second, so photographers may open up the aperture to capture dramatic flash images.

\*ist Date Body (PEISTD): Includes Logo Strap, Viewfinder Shield and Eyecup .....299.95  
 CR-2 3v Lithium Battery (GBCR2): Requires two batteries.....3.99 each  
 CF-12 Holster style case (PESCI): For \*ist Date with a compact zoom lens.....64.95  
 Remote Control F (PERCF): Infra-red remote control for \*ist Date .....14.95



# PENTAX

## \*IST DATE

### Custom Functions

- ◆ The \*ist offers 17 custom functions enabling the photographer to customize some basic camera functions to suit individual preferences. These functions include the AF pointer display in the viewfinder, the LED illuminator operation mode in the LCD panel, the order of exposures in the auto bracketing mode, and the timing of remote shutter release.

### LCD Data Panel

- ◆ Located on the back panel, is a large, easy-to-read LCD data panel with automatic illuminator that offers a full range of information with large icons and numbers to supplement the camera's user-friendly operation system. Users may activate its orange LED illuminator by turning the main switch to the preview position. With the custom functions, users may select automatic illumination under low-light conditions or deactivate the illuminator at all times.

### Viewfinder and LCD

- ◆ Bright viewfinder with full-information LCD viewfinder indicator and AF pointer. Thanks to the renowned Natural-Bright-Matte focusing screen, the \*ist offers a sharp, clear viewfinder image even in unfavorable lighting conditions. The LCD viewfinder indicator at the bottom provides a full range of information, including the selected Picture Mode and exposure compensation factors.
- ◆ For easy data confirmation, the \*ist comes equipped with automatic brightness control to change the brightness level in proportion to the subject's lighting condition. Within its image field, the viewfinder features LED AF pointers, one of which lights up to indicate the user-selected AF sensor.
- ◆ Diopter adjustment allows users to adjust the viewfinder image between -2.0m-1 and +1.0m-1 to obtain the clearest view of the subject.
- ◆ The depth-of-field preview function is electronically operated for easy confirmation of the in-focus area in the image field before the shot to help ensure photographers create their desired visual effect.

### High Performance

- ◆ The high-speed motor drive winds the film at a speed of 2.5 frames per second. You can select either single-frame advance or consecutive advance with simple push-button operation. It also simplifies film loading and rewinding operations.
- ◆ Auto exposure bracketing lets you get the right exposure. With a single shutter release, you can capture three different exposures of the same subject (in order of proper exposure, under-exposure and over-exposure) in all exposure modes (except Bulb mode). The desired compensation value ( $\pm 0.3EV$ ,  $\pm 0.5EV$  or  $\pm 1.0EV$ ) can be selected using one of the custom functions. The use of auto bracketing as well as the selected compensation value are indicated in both the LCD panel and the viewfinder display.
- ◆ Handy wireless remote control. In combination with the optional Remote Control F, the \*ist Date offers the convenience of remote shutter release from a distance. The user can select either an instant release or a three-second-delay release using one of the custom functions. The operation is confirmed by the self-timer indicator on the camera's front panel.
- ◆ Creative multi-exposure—photographers can make two exposures on a single frame with pushbutton ease to produce dramatic, eye-catching images. To expose the same frame more than three times, you simply repeat this operation after each exposure.
- ◆ Easy-setting exposure compensation and AE lock. Using the exposure compensation button and the select dial, the photographer can easily set the desired compensation value within a range of  $\pm 3EV$  in  $1/2EV$  increments (except when the metered manual mode is selected). Positioned at the upper right-hand corner of the back panel, the AE lock button makes the camera memorize the measured exposure value for approximately 20 seconds, during which period the photographer is free to re-compose the image.
- ◆ Durable metallic lens mount to hold the lens firmly in place and minimize wear caused by countless lens changes.
- ◆ Data recording capability allows users to automatically record the date, or day and time, of picture-taking on the photograph for quick, easy reference of captured images.

### \*ist Date Specifications

- Lens Mount: Pentax KAF2 (also KAF, KA & K mounts usable)
- Focus Modes: One Shot AF, continuous AF and manual
- Focus Type: TTL Phase detection (11-point AF with dual crosshair sensors)
- Focusing Sensitivity Range: EV -1 to 18 (@ ISO 100 with f/1.4 lens)
- Exposure Modes: Auto picture mode, 6 picture modes, Shutter and Aperture priority AE, metered manual & bulb
- Exposure Metering: TTL 16-segment metering, Centerweighted and Spot
- Metering Range @ ISO 100 with f/1.4 Lens: EV 0-21 (@ ISO 100 with f/1.4 lens)
- Shutter Speed: 1/4000 to 30 seconds + B, with sync at 1/125th
- Exposure Compensation:  $\pm 3 EV$  in 0.5 EV increments
- Exposure Bracketing: 3 Frames in 0.3, 0.5, or 1.0 EV increments
- ISO Range: 25-5000 (DX), 6-6400 in manual setting
- Built-in Flash: GN 39', 28mm coverage
- Film Wind: Single & continuous at 2.5 frames per second
- Focusing Screen: Fixed matte field with AF points
- Diopter Correction: (-2 to +1)
- Self Timer: 2- or 12-second delay
- Depth-of-Field Preview: Yes
- Mirror Lock-Up: with custom function
- Multiple Exposure: Yes
- Power: Two CR2 3v lithium batteries
- Dimensions: 4.8 x 3.3 x 2.5" WxHxD
- Weight: 11.8 oz (335g)

# PENTAX

## MZ-S

### 35mm SLR Autofocus Camera with Date

The MZ-S features a wide range of innovative features required for advanced photography, including a user-friendly "Hyper Operation" system, a new six-point AF system, a top shutter speed of 1/6000 second, an on-the-film data recording function, and a well designed body. When combined with high-quality SMC PENTAX lenses, the MZ-S produces excellent results, with beautiful, true-to-life images in almost any type of photographic situation.



#### FEATURES

##### High Performance

- ◆ SAFOX VII autofocus system features an extra-wide AF frame with six AF points: five points aligned horizontally, and one above the middle point. In Auto AF mode, the camera automatically selects the optimum point to capture the subject in sharp focus, even when it is far away from the center of the image field. In the Spot AF mode, you can select one of the six points manually to best suit your subject and/or application. Also offers the predictive AF function when the focus mode is set to Servo.
- ◆ Three metering modes provide exact exposure control: multi-pattern, center-weighted and spot. Six-segment metering system responds to any lighting condition with perfect exposures.
- ◆ Provides a top shutter speed of 1/6000 second to meet specialized applications.
- ◆ Record valuable data directly onto film for future reference. Film roll #, ISO speed and data-imprinting brightness are recorded on the film's leader portion, while the exposure mode, metering mode, shutter speed, aperture, exposure compensation, use of auto bracketing function and multiple exposure functions are indicated in the space between the picture frame and the perforation.
- ◆ PC connection enables use with a studio flash.
- ◆ 19 Personal Functions let you customize operation to suit your individual preferences.

##### Conveniences

- ◆ KAF2 lens mount accepts large assortment of lenses. Changing lenses in low light is easy with an illuminated lens mount index.
- ◆ Body components are made from a lightweight, extra-strong die-cast magnesium alloy for rugged use and high performance.
- ◆ Positioned inside the select dial, the large LCD panel presents a host of valuable operational data at a glance. An electro-luminescence illuminator makes it easy to read data reading in the dark.
- ◆ Dramatically slanted top panel not only makes camera operation more accessible, but also provides a quick, effortless confirmation of the LCD panel and other settings.
- ◆ Electronic preview lever lets you check the depth of field without having to take your eye off the viewfinder.
- ◆ Large, analog dial controls with electronic precision make for easy adjustments with quick visual verification on the LCD panel. Just one dial allows adjustment of shutter speeds, autofocus points, ISO settings and custom functions; another large dial control allows adjustment of exposure compensation, auto bracketing settings, and other control functions with one touch.
- ◆ Hyper operation control allows instant mode-changing from Programmed Auto to shutter- or aperture-priority exposure to metered manual exposure modes, with just one turn of the main control dial.

##### MZ-S Specifications

- Lens Mount: Pentax KAF2 (also KAF, KA & K mounts usable)
- Focus Modes: One Shot AF, continuous AF and manual focus
- Focus Type: TTL Phase detection (6-point AF with dual crosshair sensors)
- Exposure Modes: Programmed AE, Shutter and Aperture priority AE, manual and Bulb
- Exposure Metering: 6-Zone Evaluative, Centerweight and Spot
- Metering Range @ ISO 100 with f/1.4 Lens: EV 0-21
- Shutter Speed: 1/6000th to 30 Seconds + B, with sync at 1/180th second
- Exposure compensation and bracketing:  $\pm 3$  EV in 0.5 EV increments
- ISO range: 25-5000 (DX), 6-6400 in manual
- Built-in Flash: GN39', 28mm coverage
- Film Wind: Single & continuous at 2.5 fps
- Focusing Screen: Interchangeable, includes overall matte field with AF points
- Diopter Correction: Built-in -2.5 to +1.5
- Self Timer: 10-Second delay
- Remote Control: Yes (requires BG-10 grip)
- PC Terminal: Yes
- Depth-of-Field Preview: Yes
- Mirror Lock-Up: with custom function F14
- Multiple Exposure: Yes
- Power Source: 2 CR2 3v lithium batteries
- Dimensions: 5.4 x 3.7 x 2.5"; 1.14 lb.

MZ-S Body (PEMZSD): Includes strap and one-year warranty .....799.95



EQUIPMENT LEASING AVAILABLE

# PENTAX

## Accessories for \*ist, ZX-M and MZ-S

### Right-Angle Finder A (PEFRAA)

A 360° rotating angle viewfinder for easier viewing on a reproduction stand or for shots from a worm's-eye view. It has built-in 2x magnification, a vertically and laterally correct image and an adjustable diopter. ...**369.95**

### Diopter Correction Lenses

Clip-on prescription eyepieces designed for eye glass wearers.

- 5 Diopter M (PEDM5M).....**19.95**
- 4 Diopter M (PEDM4M).....**19.95**
- 3 Diopter M (PEDM3M).....**19.95**
- 2 Diopter M (PEDM2M).....**19.95**
- 1 Diopter M (PEDM1M).....**19.95**
- +1 Diopter M (PEDP1M).....**19.95**
- +2 Diopter M (PEDP2M).....**19.95**
- +3 Diopter M (PEDP3M).....**19.95**

### FB 2X Magnifier (PEMFB)

Recommended for critical focusing, this clip-on hinged magnifier adds 2x magnification to the central portion of the focusing screen. It can be raised to view the entire focusing screen, and has a built-in eyepiece correction lens with an adjustable diopter range .....**49.95**

### Microscope Adapter B (PEMA)

This adapter is designed to fit the camera body directly onto a microscope. It can be used with any microscope having a 25mm outside diameter tube. When used on these cameras, aperture-priority exposure is retained .....**99.95**

### Helicoid Extension Tube B (PEETH)

The "Adjustable Extension Tube", the internal helicoid tube provides an infinitely stepless adjustment range for 26.5mm to 46.5mm. Manual diaphragm and stop-down metering operations are required with all lenses. Magnification range with a 50mm lens is .50x-1.00x. May be combined with either Auto or Manual Extension tubes for greater magnification.....**109.95**

### Reverse Adapter (PERA52)

Permits 52mm lenses to be mounted on a Pentax camera body or extension tubes in reverse position for better image quality at magnifications greater than 1.0 (1:1), and for higher magnifications with less extension. When used with a Pentax automatic exposure camera, aperture priority automation is retained within the measurable range. Magnification of reversed 50mm lens is approximately .60x.....**19.50**

### Macro Focus Rail III (PEMFR3MPS)

Provides fast, accurate and precise focusing for close-up and extreme magnification (5x or more), precisely setting the position of the lens, or extension tube. It is also useful for making close-ups with a predetermined magnification. Has a tripod socket .....**169.95**



### AA Battery Packs

#### AA Battery Pack FG for ZX-M (PEBPFG):

Powered by 4 AA batteries, Battery Pack FG adds a vertical grip to the camera body. It advances from 20-200 rolls of 24 exposure film (depending on flash usage), and offers increased balance and handling .....**19.95**

#### BG-20 Battery Grip for \*ist (PEBG20):

Battery grip powered by four AA batteries. Usability is enhanced with the shutter release and AE lock buttons for vertical positioning of the camera.....**59.95**

#### BG-10 Battery Grip for MZ-S (PEBG10):

Uses four AA-sized batteries to power the MZ-S. This dramatically increases the film count before changing batteries, plus adds a vertical release to the camera.....**144.95**

### Cable Switches

#### Cable Switch F for ZM-M (PECSF):

This 3.5' cable release trips the shutter electronically, without transferring mechanical movement to the camera. Pressing the cable release switch partway will activate the camera's metering and/or autofocus, and a locking switch is provided for long time exposures .....**28.95**



#### CS-205 Cable Switch for \*ist (PECS205):

A 1.7' cable release that helps prevent camera shake when shooting super telephoto shots, macrophotography and bulb exposures. Handy for taking pictures of subjects that are difficult to approach, or to minimize vibration for close-ups and time exposure .....**34.95**

#### CS-105 Cable Switch for MZ-S (PECS105):

Same as above, for the MZ-S.....**59.95**

#### CS-130 Cable Switch for MZ-S (PECS130):

Same as above, but with a 10' reach.....**69.95**

#### Cable Release 30 (PECR30):

12" cable release with a locking collar to allow time exposures. Fits any camera that accepts standard mechanical cable release .....**17.95**

#### Cable Release 50 (PECR50):

Same as above with a 20" reach.....**19.95**

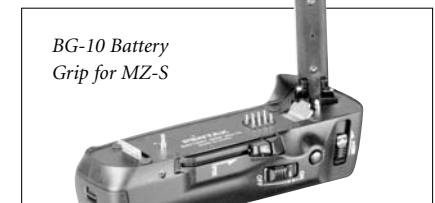

BG-10 Battery Grip for MZ-S

Accessories for the MZ-S:



#### TS-110 Release Timer Switch (PETS110):

Acts as a standard cable switch and has a built-in timer to perform interval shooting, extended-time bulb exposures, and designated time shooting. 3.3' long .....**134.95**

#### GG-60 Focusing Screen (PEFSGG60):

Matte with Grid & Crosshairs .....**34.95**

CF-10 (S) Case (PECSMZS): fits up to 28mm f/2.8, 43mm f/1.9 or 50mm lenses.....**49.95**

CF-10 (M) Case (PECMZS): (fits up to 100mm f/3.5 Macro, 135mm f/2.8 or 28-70mm f/4 lenses.....**54.95**

CF-10 (L) Case (PECLMZS): Fits up to 100mm f/2.8 Macro, 28-105mm f/4 or 70-200mm f/4 lenses..**59.95**

# PENTAX

## AUTOFOCUS LENSES

### WIDE ANGLE and ULTRA WIDE ANGLE LENSES

#### **SMCP-FA 20mm f/2.8 (PE2028FA)**

A super wide-angle lens with a 94° field of view for sweeping landscapes and dramatic interior shots. Light and precise, it will render subjects with excellent contrast and no color fringing. Pentax's exclusive SMC (Super Multi-Coating) process gives incredibly high transmissivity (the retention of light passing through the reflective elements within a lens) to make the lens up to 10% brighter than an equivalent 20mm f/2.8 lens with conventional coatings. Includes soft lens case. Filter size is 67mm .....**499.95**



SMCP-FA  
20mm f/2.8

SMCP-FA 24mm  
f/2.0 AL IF

#### **SMCP-FA 24mm f/2.0 AL IF (PE242ALFA)**

The 24mm F2 is a moderate wide-angle lens that offers outstanding versatility and is well suited for architectural and landscape photography. Its compact and lightweight dimensions make it ideal for traveling. An eight-blade aperture diaphragm provides excellent out of focus blur, and internal floating lens elements insuring optimal results throughout the focus range. Treated with SMC coating for maximum light transmission, sharp definition, and high contrast while minimizing flare and ghost imaging. Includes PH-RBA67 Lens Hood and a soft case. Filter size is 67mm .....**379.95**

#### **SMCP-FA 28mm f/2.8 AL (PE2828FA)**

The 28mm F2.8 is often the standard choice for wide angle photography, offering good coverage without limiting distortion. It is also ideally suited for architectural and landscape photography. Provides a bright viewfinder image while the simple five-element lens formula renders high-contrast images. Aspherical lens element helps transmit the light more efficiently through the lens to the film. Treated with SMC coating for maximum light transmission, sharp definition, and high contrast while minimizing flare and ghost imaging. Compact and lightweight, it measures 2.5 x 1.6" and weighs a mere 6.5 ounces. Filter size is 49mm .....**229.95**

SMCP-FA  
28mm  
f/2.8 AL



#### **SMCP-FA 31mm f/1.8 AL Limited Edition (PE3118FA)**

Offering exceptionally high image quality and a beautiful aluminum body with metallic silver finish, the SMCP-FA 31mm f/1.8 AL Limited Edition incorporates a glass-molded aspherical lens element into its 9-element, 7-group optics to provide sharp, crisp image reproduction, even at the maximum aperture of f/1.8, with a very soft rendition of out-of-focus areas. The floating mechanism effectively compensates for fluctuating aberrations, especially when photographing relatively close subjects. It offers a minimum focusing distance of just 12". Comes equipped with a specially-designed flower-shaped lens hood, which not only cuts down excessive light, but also allows for easy attachment and removal of filters. Filter size is 58mm ..**879.95**

SMCP-FA  
31mm f/1.8  
AL Limited  
Edition



#### **SMCP-FA 35mm f/2 AL (PE352ALFA)**

Weighing a mere 6.9 oz. the SMCP-FA 35mm f/2 AL is one of the most compact and light-weight wide-angle lenses available. It incorporates a high-quality aspherical lens element to effectively compensate for spherical aberrations. It produces sharp, high-contrast images from the minimum focusing distance (1 ft.) to infinity. Additionally, it assures outstanding image resolution from edge to edge, even at the maximum f/2 aperture. Pentax's acclaimed SMC (Super-Multi-Coating) provides maximum light transmission, sharp definition, and high contrast, while minimizing flare and ghost imaging, even in backlit conditions. A large, detachable flower-shaped lens hood (included) effectively shields the lens from excessive incident light, plus has a window that allows you to rotate the polarizing (PL) filter to control the amount of polarization without removing the hood from the lens. Filter size is 49mm .....**299.95**

SMCP-FA  
35mm f/2 AL





# PENTAX

## AUTOFOCUS LENSES

### STANDARD LENSES

#### **SMCP-FA 43mm f/1.9 Limited Edition** (PE4319FA)

In the 35mm format the ideal definition of a “standard” lens is 43mm, the distance from the corner to corner on a frame of 35mm film. Featuring an elegant, high-quality look with a beautiful satin chrome finish, the 43mm f/1.9 Limited Edition offers true-to-life image reproduction with a focal length that offers a natural perspective with a fine definition of depth. High-refraction lens elements minimize spherical aberration, coma flare and chromatic aberration to produce sharp, well-defined images even in poorly illuminated areas of the picture. This also assures a soft, natural reproduction in out-of-focus areas. Images are sharp and contrasty thanks to Pentax’s SMC (Super Multi Coating) process, which results in a high retention of light. An incredibly lightweight lens with ultra-thin body design, the well-balanced mechanical design of the focus ring and aperture ring assures smooth, comfortable operation. Includes a metal lens hood and soft lens pouch. Filter size is 49mm .....479.95

SMCP-FA  
43mm f/1.9  
Limited  
Edition



#### **SMCP-FA 50mm f/1.4** (PE5014FA)

A standard lens for Pentax autofocus cameras with a bright f/1.4 aperture, the 50mm lens provides an angle of view and perspective similar to the human eye. Its natural perspective of subjects makes it ideally suited for everyday use including indoor photography, traveling, and hiking. Excellent for low-light handheld photography. Pentax SMC (Super Multi Coating) process provides the highest possible transmission of light. Filter size is 49mm.....209.95



SMCP-FA  
50mm f/1.4

CAMERAS & LENSES

145

### PORTRAIT LENSES

#### **SMCP-FA 77mm f/1.8 Limited Edition** (PE7718FA)

The SMCP-FA 77mm f/1.8 Limited Edition is a versatile, high resolution medium-telephoto lens specifically designed with portrait and snapshot applications in mind. As a result, it accurately reproduces the tones, colors and texture of the subject’s skin, clothes and accessories as well as assuring an excellent rendering of highlight and out of focus areas. The lens also features Pentax’s exclusive FREE (Fixed Rear Element Extension) focusing system to ensure sharp, crisp image reproduction over the entire focusing range. Beautifully finished with an aluminum lens barrel and a dark green indicator for easy lens attachment, the lens is treated with Pentax’s acclaimed SMC (Super-Multi-Coating) for maximum light transmission, sharp definition, and high contrast, while minimizing flare and ghost imaging. Has built-in lens hood. Filter size is 49mm.....689.95



SMCP-FA  
77mm f/1.8  
Limited Edition

#### **SMCP-FA\* 85mm f/1.4 IF** (PE8514FA)

A 9-blade aperture diaphragm and fantastic multicoating distinguish this portrait lens. Solidly built, this is a confidence inspiring lens, with a large bayonet mounting hood supplied as standard. It is quite short, but wide construction and weighty feel give the impression of a “barrel of glass”. Internal floating lens elements give optimal results throughout the focus range. FA\* lenses make use of a “de-clutching” mechanism to switch between manual and auto-focus. This improves the handling as the focus ring doesn’t revolve when in the AF position. When in the manual focus position the lens has a better feel than most other AF lenses. Includes MH-RBB67 Lens Hood and a soft case. Filter size is 67mm .....799.95



SMCP-FA\*  
85mm  
f/1.4 IF

ORDER & INFO. (212) 502-6340 • FAX: (212) 239-7770 (800) 947-7008  
1-800-290-6750 • [www.bhphotovideo.com](http://www.bhphotovideo.com)



# PENTAX

## AUTOFOCUS LENSES

### MACRO LENSES

#### **SMCP-D FA 50mm f/2.8 & 100mm f/2.8 Macro**

The SMCP-D FA 50mm F2.8 Macro and SMCP-D FA 100mm F2.8 Macro are designed to optimize image quality in both digital SLR and film photography. They offer a maximum magnification of 1x (life size), producing impressive, well-defined macro images. They feature an image circle accommodating the image size (36mm x 24mm) of 35mm format SLR film cameras. As a result, the lenses produce high-quality images with edge-to-edge, vignette-free sharpness even when mounted on conventional 35mm format SLR cameras. Well known for advanced optical design technologies, Pentax optimizes the optical characteristics of the new lenses with lens coating and curvature and positioning of optical elements. In particular, lens flare and ghost have been reduced to a minimum for clear, high-quality digital images.

- ◆ Each lens is equipped with an aperture ring to accommodate the lens-set aperture-priority AE and metered manual modes assuring fingertip aperture control from the shooting position.
- ◆ The 100mm F2.8 Macro incorporates the FREE (Fixed Rear Element Extension) focusing system, while the 50mm F2.8 Macro features the dependable floating system. These systems ensure exceptional focusing distance to infinity by effectively reducing annoying aberrations at any focusing distance.
- ◆ Wide focusing ring assures fast, high-accuracy focusing in manual-focus mode.
- ◆ Built-in focus-clamp mechanism to fix focus at any distance
- ◆ Large lens hood effectively shields the lens surface from excessive incident light
- ◆ Both are designed to be extremely compact and lightweight. Filter size is 49mm

|   |        |
|---|--------|
| SMCP-FA 50mm f/2.8 Macro (PE5028MDFA) .....   | 429.95 |
| SMCP-FA 100mm f/2.8 Macro (PE10028MDFA) ..... | 564.95 |



### TELEPHOTO LENSES

#### **SMCP-FA 135mm f/2.8 IF (PE13528FA)**

The 135mm focal length has long been a favorite of photographers, being great for portraits with well-blurred backgrounds as well as creating a compression roughly equivalent to the human eye when focusing on a particular element of the landscape. The SMCP-FA 135mm F2.8 (IF) is a great portrait lens as it allows a comfortable distance between the photographer and subject. It allows for a shallow depth of field and is ideal for working in low-light conditions. It features an internal focus system to make focusing smoother and faster, and is treated with SMC coating for maximum light transmission, sharp definition, and high contrast while minimizing flare and ghost imaging. Has a built-in lens hood. Filter size is 52mm .....

#### **SMCP-FA 200mm f/2.8 ED-IF (PE20028FA)**

A fixed, non-rotating lens front, chromatic aberration-free optics and Pentax's unique SMC coating are traits of this ultra-sharp telephoto prime lens. The 200mm F2.8 (IF) telephoto is an ideal lens for sports and wildlife photography. Easy to maneuver and not bulky, it is ideal for working in low-light conditions. It features an internal focus system to make focusing smoother and faster, and is treated with the acclaimed SMC coating for maximum light transmission, sharp definition, and high contrast while minimizing flare and ghost imaging. Minimum focusing distance is 4.7'. Includes a lens hood and soft carrying case. Weighs 25 oz. Filter size is 77mm .....



For Any Inquiries Regarding Your Order, Call Our Customer Service:  
(800) 221-5743 • (212) 239-7765 • FAX: (800) 947-2215 • (212) 239-7549

# PENTAX

## AUTOFOCUS LENSES

### ZOOM LENSES

#### **SMCP-FA J 18-35mm f/4-5.6 AL** (PE18354JFAAL)

The ideal lens for the photo enthusiasts looking for a compact ultra wide to wide angle lens. With a minimum focus distance of only 11" and a wide-angle zoom range of 18-35mm, this lens is ideal for landscape, candid, environmental, close-up and full-length portrait photography. This 'J' type lens is a compact, light-weight lens that was designed to match the smaller size of the \*ist camera. One of the ways the smaller size was made possible was by removing the aperture ring control from the lens. All aperture changes can be done directly on the camera. (Note: This lens is not compatible with some of the older PZ series cameras, or with manual exposure camera models). Includes PH-RBL lens hood. Filter size is 67mm .....**164.95**

#### **SMCP-FA Zoom 20-35mm f/4 AL** (PE20354FA)

Only 2.7" long and weighing just 8.6 oz. this compact zoom lens covers angles of view from an ultra-wide 94° at the 20mm setting to a wide 63° at 35mm. It is constructed of ten elements in eight groups, has a fully automatic diaphragm, and features TTL open-aperture metering, with a minimum aperture of 22. Two aspherical lens elements reduce distortion to a minimum, even at 20mm for sharp, crisp image reproduction. It features zoom macro capability down to 12". Includes a case as well as detachable flower-shaped lens hood with a polarizing filter adjustment window, which allows you to rotate the polarizing filter without removing the hood from the lens. Filter size is 58mm .....**499.95**



SMCP-FA J  
18-35mm f/4-5.6

SMCP-FA Zoom  
20-35mm f/4 AL

SMCP-FA  
24-90mm  
f/3.5-4.5  
AL [IF]



SMCP-FA  
28-70mm  
f/2.8 AL

#### **SMCP-FA 24-90mm f/3.5-4.5 AL [IF]** (PE249035FA)

This versatile 3.75x zoom lens covers the most frequently used focal lengths (from 24mm wide angle to 90mm medium telephoto) and offers a minimum focusing distance of 1.65' at any focal length. Thanks to the incorporation of two aspherical lens (AL) elements and extra-low-dispersion glass lens elements, it offers a high-contrast, high-resolution image reproduction over its entire zoom range. It also features internal-focus (IF) mechanism and ghostless lens coating to offer a bright, true-to-life image throughout the image field "even at the edges" when the picture is taken with a wide-angle setting at a close distance and against backlight. In addition, it comes equipped with a flower-shaped oval lens hood, which not only effectively shields the lens from excessive light, but also allows you to attach and remove the lens cap and adjust the polarizing filter through a window without having to remove the lens hood. Filter size is 67mm .....**429.95**

#### **SMCP-FA 28-70mm f/2.8 AL** (PE287028FA)

The 28mm~70mm f/2.8 is ideal for advanced amateurs and professionals. It provides wide-to-telephoto zoom coverage and high-quality image reproduction and features a maximum aperture setting of 2.8 throughout the zoom range. Autofocus is quiet and responsive. Zoom can be power-operated or done manually. Floating internal elements deliver optimal results throughout the focusing range. Features Pentax's acclaimed SMC coating to maximize light transmission and produce sharp, high-contrast images while minimizing flare and ghost imaging. Includes PH-RBC77 lens hood and soft case. Filter size is 67mm.....**1019.95**

# PENTAX

## AUTOFOCUS LENSES

### ZOOM LENSES

#### **SMCP-FA J 28-80mm f/3.5-5.6 AL** (PE288035JFAA)

A standard zoom lens from a wide 28mm to a medium telephoto range of 80mm, this 'J'-type lens is a compact, light-weight lens that was designed to match the smaller size of the \*ist and ZX-60 cameras. One of the ways the smaller size was made possible was by removing the aperture ring control from the lens. All aperture changes can be done directly on the camera. Treated with the acclaimed SMC-multi-coating to produce sharp, high-contrast images with minimal aberrations. (Note: This lens is not compatible with some of the older PZ series cameras, or with manual exposure camera models). Filter size is 58mm .....**59.95**

#### **SMCP-FA 28-90mm f/3.5-5.6 L** (PE289035FA)

The 28mm~90mm f/3.5~f/5.6 is a standard zoom lens ideal for both beginner and advanced photographers. It features super-compact dimensions and covers the most frequently-used focal length range — from 28mm wide angle to 90mm telephoto. Incorporates ten elements in eight groups and features a minimum focusing distance of 1.3 feet at any focal length. Its extra-compact, lightweight body measures 2.6 x 2.7" and weighs just 6.9 ounces. Filter size is 58mm.....**79.95**

#### **SMCP-FA 28-105mm f/3.2-4.5 AL IF** (PE2810532FA)

The SMC-FA 28-105mm lens is one of the most compact and light-weight in its category. Thanks to the incorporation of a hybrid aspherical lens element, it measures only 2.6" in diameter and 2.6" in length and weighs a mere 9.0 ounces. This aspherical element also contributes to the improvement in image quality and the reduction of coma and spherical aberrations. Image quality is further enhanced by the application of Pentax's original SMC ghostless coating. Other features include zoom macro capability down to 1.65'; an inner focus mechanism for fast, flawless focusing operations; and a flower-shaped lens hood (PH-RBC58) with a polarizing filter adjustment window. Filter size is 58mm .....**209.95**

#### **SMCP-FA J 75-300mm f/4.5-5.8 AL** (PE7530045FAB)

This telephoto-zoom lens is ideal for sports, portraiture, animals, etc. The telephoto effect can make the picture look compressed or have excellent background blur. This 'J'-type lens is compact and lightweight, designed to match the smaller size of the \*ist and ZX-60 cameras. One of the ways the smaller size was made possible was by removing the aperture ring control from the lens. All aperture changes can be done directly on the camera. Treated with the acclaimed SMC-multi-coating it produce sharp, high-contrast images with minimal aberrations. (Note: This lens is not compatible with some of the older PZ series cameras, or with manual exposure camera models). Filter size is 58mm .....**129.95**



SMCP-FA J  
28-80mm  
f/3.5-5.6 AL

SMCP-FA 28-90mm  
f/3.5-5.6 L

SMCP-FA  
28-105mm  
f/3.2-4.5 AL IF

SMCP-FA J  
75-300mm  
f/4.5-5.8 AL



# PENTAX

## AUTOFOCUS LENSES

### TELEPHOTO ZOOM LENSES

CAMERAS & LENSES

149



SMCP-FA  
80-200mm  
f/4.7-5.6

SMCP-FA  
100-300mm  
f/4.7-5.8 A

#### SMCP-FA 80-200mm f/2.8 ED-IF (PE8020028FA)

A fast telephoto zoom with a constant bright aperture and outstanding optics. The 80mm-200mm f/2.8 lens is a moderate to long telephoto lens flexible enough to use in a variety of situations including sports and portrait photography. It provides a maximum aperture setting of 2.8 throughout the zoom range and incorporates a high-refraction extra low dispersion (ED) glass element to produce a high-resolution, high-contrast image with true-to-life color rendition. Pentax SMC multicoating gives the maximum light transmission. The zoom can be power-operated or moved manually. The tripod collar is removeable. Internal floating elements give optimal results throughout the focus range at all focal lengths. Includes soft lens case and PH-RBC77 lens hood. A great lens for photojournalism or portraiture. Filter size is 77mm.....1369.95

#### SMCP-FA 100-300mm f/4.7-5.8 A (PE10030047AS)

The SMCP-FA Zoom 100mm-300mm f/4.7-5.8 features a wide 3x zoom range covering a 100mm medium-telephoto to a 300mm super-telephoto range, making it versatile enough for many different subjects - from casual snapshots and portraits to sports and wildlife photography. This lens also incorporates zoom macro capability with a minimum focusing distance of 4.9' and reliable autofocus operation in combination with the ZX series SLR cameras. Pentax SMC multi-coating produces sharp, high-contrast images with minimal aberrations and gives maximum light transmission. Filter size is 58mm.....169.95

**FILTERS:** *The purpose of any filter - colored, UV, or polarizing - is to give the photographer greater control by determining the kind of light which enters his lens. Colored filters effect the picture by absorbing certain light wavelengths or color values and heighten the importance of others. Ultra-Violet filters absorb the ultra-violet wavelengths. Almost all light sources produce UV rays - the sun, fluorescent lights, flash bulbs or electronic flashes. Though the human eye cannot actually see UV rays, if they are not absorbed, they will create a haze effect over the photograph. (Most colored filters are also treated to absorb UV rays.) Polarizing filters cut through reflections by absorbing certain right-angle ray vibrations. Because Pentax SLRs have TTL exposure meters built in, they automatically adjust for the change in light produced by the filter.*

|                    |                  |                  |                  |                  |                  |                  |
|--------------------|------------------|------------------|------------------|------------------|------------------|------------------|
| Skylight 1A        | PESL49<br>24.95  | PESL52<br>24.95  | PESL58<br>34.95  | PESL62<br>54.95  | PESL67<br>54.95  | PESL77<br>59.95  |
| UV                 | PEUV49<br>24.95  | PEUV52<br>24.95  | PEUV58<br>34.95  | PEUV62<br>54.95  | PEUV67<br>54.95  | PEUV77<br>59.95  |
| 81A                | PE81A49<br>24.95 | PE81A52<br>24.95 | PE81A58<br>34.95 | PE81A62<br>54.95 | PE81A67<br>54.95 | PE81A77<br>59.95 |
| Circular Polarizer | PECP49<br>64.95  | PECP52<br>64.95  | PECP58<br>79.95  | PECP62<br>109.95 | PECP67<br>109.95 | PECP77<br>164.95 |
| Orange 02          | PEO49<br>24.95   |                  | PEO58<br>34.95   | PEO62<br>54.95   | PEO67<br>54.95   | PEO77<br>59.95   |
| Red R2             | PER49<br>24.95   |                  | PER58<br>34.95   | PER62<br>54.95   | PER67<br>54.95   | PER77<br>59.95   |
| Yellow #Y2         | PEY49<br>24.95   |                  |                  | PEY62<br>54.95   | PEY67<br>54.95   | PEY77<br>59.95   |

ORDER & INFO. (212) 502-6340 • FAX: (212) 239-7770 (800) 947-7008  
1-800-290-6750 • [www.bhphotovideo.com](http://www.bhphotovideo.com)



# PENTAX

## FLASHES

CAMERAS & LENSES

150

### Sync Cords for

#### AF-400T or Hot Shoe Grip

**4P Sync Cord A (PESCA4P):** For PC terminal of LX camera—retains TTL and dedicated flash functions (3' long) .....**33.95**

**4P Sync Cord B (PESCB4P):** For hot shoe contact. Can be used on all camera bodies; retains TTL and dedicated flash functions where applicable (3' long) .....**44.95**

**4P Sync Cord C (PESCC4P):** For standard PC terminal/Non-TTL (3' long) .....**33.50**

**4P Sync Cord A (PESCA4P16):** For PC terminal of LX camera; 16' long .....**44.95**

**4P Sync Cord B (PESCB4P16):** For hot shoe contact; 16' long .....**49.50**

**Distributor for Multistrobe Lighting (PED)**  
Allows the use of up to three flash units for fully synchronized multi-flash photography. Attaches to camera via a 4P Sync Cord. Retains camera and flash automatic functions when used with 4P Sync Cord A or B. Connects to AF-400T or Hot Shoe Grip with 5-meter 4P Multi Sync Cord .....**39.95**

### Off-Camera Operation

Used together, the Hot Shoe Adapter FG and Off-Camera Shoe Adapter F permit off-camera flash operation with ZX-series SLR cameras and AF-220T, AF-360FGZ, and AF-500FTZ flashes. The Extension Cord F5P or F5PL connects the two of them together.

Alternatively, you can combine a Hot Shoe Adapter F and Extension Cord F5/F5PLP.

#### Hot Shoe Adapter F (PEHSAF)

Features a hot shoe connection on the top and bottom, plus a 5P (5 pin) cable connection on its side. 1.2 x .9 x 1.1" .....**24.95**

#### Hot Shoe Adapter FG (PEHSAFG)

Attaches to the camera hot shoe .....**35.95**

#### Off-Camera Shoe Adapter F (PEOCSAF)

Provides the same functions as the Hot Shoe Adapter FG without occupying the TTL hot shoe. It has a hot shoe on the top, and a 1/4-20" threaded hole at the bottom ....**42.95**

**3' Extension Cord F5P (PEECF5P) .....24.95**

**9.5' Extension Cord F5PL (PEECF5PL) .54.95**



#### AF-201SA TTL Shoe Mount Flash (PEAF201SA)

Compact and lightweight, the AF-201SA is a dedicated auto flash that is the perfect companion for the ZX-M. Featuring an easy clip-on mounting mechanism, this series-controlled flash offers Programmed Auto Flash operation, a 35mm wide-angle coverage, and a guide number of 20 (at ISO 100/m). When mounted on the hot-shoe of the ZX-M, it automatically sets the X-sync speed when power is turned on. It also selects the appropriate aperture for the film used (provided that a A, F or FA series lens is used). Powered by 4 AA alkaline batteries .....**39.95**

#### AF-220T TTL Shoe Mount Flash (PEAF220T)

A compact and lightweight flash featuring an advanced TTL auto flash system, vertically adjustable flash head with a guide number of 22 (ISO 100/m), and an illumination range of 2.3 to-18'. Used with Pentax PZ- and ZX-series autofocus cameras, the flash discharge level is automatically adjusted; when turned on, the camera's X-sync speed is automatically selected and the flash-ready mark in the camera's viewfinder lights up. In addition to the conventional horizontal position, the flash head can be set at a 60- or 90° angle to the subject for bounce flash photography. Powered by 4 AA alkaline or nicad batteries .....**49.95**



#### AF-280T TTL Thyristor Auto Shoe Mount Flash (PEAF280T)

The AF-280T features powerful guide number of 92 (ISO 100/m) and 28mm wide angle coverage, yet the flash is extremely compact, lightweight and well-balanced. TTL mode delivers an automatic exposure range from 0.8 to 65' with an f/1.4 lens and ISO 100 film. In automatic it allows you to select from two aperture settings (f/4 and f/8) for depth-of-field control and a maximum automatic operating distance of 24'. Override allows for total manual control and synchronization at speeds other than "X". A versatile shoe mount unit, the AF-280T features a rotating flash head with 270° horizontal and 90° vertical settings plus a -15° setting for closeup work. The rotating head is especially useful for bounce or angle flash in the TTL mode. Powered by 4 AA alkaline or nicad batteries .....**169.95**



#### AF-360FGZ TTL Power Zoom Flash (PEAF360FGZ)

The professional AF-360FGZ works with all cameras. Full manual control of flash output is possible, or use the TTL flash capabilities of the camera to achieve easy exposure with every aperture. The pop-up flash incorporated into many Pentax SLRs can be used to trigger the AF-360 FGZ wirelessly, and when combined with the MZ-S this is done with TTL metering. Powered by 4 AA alkaline, lithium, or NiMH batteries.

- ◆ Auto zoom head covers from 24-80mm (includes 20mm wide angle adapter)
- ◆ Full TTL at all apertures ( with TTL-capable Pentax cameras )
- ◆ Second-curtain sync, illuminated LCD panel, AF infrared lowlight assistance
- ◆ Vari-Power 1/1, 1/2, 1/4th, 1/8th, 1/16th and 1/32nd

- ◆ When used with the MZ-S, it offers "P-TTL" Preflash evaluative metering, "HSS" Focal plane high-speed flash sync, wireless TTL capability with ratio lighting control & four transmission channels, and Stroboscopic flash allows user to preview flash effects



**\$209<sup>95</sup>**



For Any Inquiries Regarding Your Order, Call Our Customer Service:  
(800) 221-5743 • (212) 239-7765 • FAX: (800) 947-2215 • (212) 239-7549

# PENTAX

## FLASHES

CAMERAS & LENSES

151

### AF-400T TTL

#### Handle Mount Flash Kit (PEAF400TK)

The AF-400T is a professional handle mount unit for those who require maximum light output with total automatic and manual exposure control plus a wide variety of internal and external power source options. Handsomely-styled, it offers a guide number of 130 (ISO 100/m) and fully integrated TTL automatic exposure control with a host of Pentax cameras. It features TTL (up to 108-ft.), three power settings with Auto Flash (up to 33-ft.), and four power settings (full, 1/4, 1/16 or 1/25) with manual operation. Its rotating flash head can be adjusted 270° horizontal, 90° vertical and features a -15° setting for close-ups. The vertical angle can be further adjusted by changing the adjustment angles on the bracket and clamp. Includes clamp, quick release bracket, AA Grip Battery Pack and 4P Sync Cord B.....**439.95**



### AF-500FTZ TTL Power Zoom Flash (PEAF500FTZ)



A shoe-mount flash, the AF-500FTZ has full TTL exposure control with the ZX, PZ and SF autofocus cameras, and its internal zoom head automatically adjusts to the F or FA zoom lens setting when the camera's shutter button is pressed. The 24-85mm zoom range can also be set manually. The AF-500FTZ has a guide number of 50 (ISO 100/m) and can be used in TTL Auto or adjustable manual modes.

There is a Multiple Flash mode for stroboscopic flash effects, and the flash head tilts 90° vertically and swivels 270° horizontally. Other features include AF Spotbeam Projector for low-light autofocus and full information illuminated LCD panel.

To combine existing light and flash, Leading Shutter Curtain Sync and Trailing Shutter Curtain Sync modes are available. The Contrast Control Sync mode gives a 1:2 lighting ratio with the PZ's RTF flash. For cable-free, off-camera manual flash operation, a built-in slave trigger is fired by the on shoe-mount flash .....**299.95**

### AF140-C Macro Ring Light Flash (PEAF140C)

The AF140-C is a TTL auto flash with a guide number of 14 (ISO 100/m) for shadowless macro flash photography. It has a 360° circular flash head that clips-on to the camera lens to provide even illumination for a wide variety of subjects. It also has four separate flash tubes, so depending on lighting conditions, the tubes can be manually selected to fire either as one or two pairs, for perfect exposures and three dimension flash effects.



- ◆ Built-in modeling light to check lighting conditions
- ◆ Manual flash capability, in addition to the TTL auto flash mode
- ◆ Aperture can be manually selected in the TTL auto flash mode. When the camera's aperture is set to auto, the flash selects f/5.6 or f/22 automatically for proper exposure.
- ◆ Operates jointly with the AF Ring Light Control Unit, which attaches directly to the camera's hot-shoe.
- ◆ Powered by 4 AA alkaline or nicad batteries
- ◆ Includes soft case and 49mm, 52mm and 58mm attachment adapters .....**389.95**

### Hot Shoe Grip (PEGHS):

For using Hot Shoe type flash units off camera. Must be used with 4P Sync Cords A, B, or C. Retains all TTL and dedicated functions where applicable. Has tripod socket on bottom cover .....**44.95**

### Cold Shoe Clamp (PECL10):

For remote use .....**54.95**

### Hot Shoe Adapter 2P (PEHSA2P):

For cameras without PC terminals. Attaches to camera's hot shoe; has a standard PC terminal. Use with ZX, PZ and flash units that require a PC cord connection .....**31.95**

### TR Power Pack II

#### for AF-500FTZ Flash (PETRPP2):

Uses 6 "C" batteries to give approximately 400 flashes with 4-sec. recycle time with fresh alkaline (only) batteries. Comes with case, power cord and strap .....**129.95**

### Transistor Pack

#### for AF-400T (PETPPAF400T):

Power stored in units transistor circuitry for fast recycle time. Uses 6 "C" cell batteries. Carry with either the supplied shoulder strap or belt loop. Approx. 210 flashes available with 17-second intervals at full power with alkaline batteries, 150 flashes with nicad batteries. Recycle time is 7 seconds with fresh alkaline or 6 seconds with fully charged nicad batteries at full power .....**119.95**



### 510v Power Pack

#### for AF-400T (PEPP510AF400):

Uses a 510v high-voltage laminated battery. Has greatest number of flashes and faster recycling time than other portable power sources. Carry with either the supplied shoulder strap or belt loop. Approx. 300 flashes available with 30-second intervals at full power. Recycle time is 2 seconds at full power with fresh batteries .....**197.95**

### AFT-2 Telephoto Adapter II

#### for AF-400T (PETA2AF400T):

Concentrates flash beam when using telephoto lenses .....**27.95**

### AFW-2 Wide Angle Adapter II

#### for AF-400T (PEWAA2AF400T):

Extends flash coverage to use with wide angle lenses down to 24mm .....**16.50**

ORDER & INFO. (212) 502-6340 • FAX: (212) 239-7770 (800) 947-7008  
**1-800-290-6750 • www.bhphotovideo.com**



# PHOENIX

## MANUAL FOCUS LENSES



### 24mm f/2.8 Wide Angle Lens

Perfect for all those wide-angle shots where you want to get more of an area in the photograph such as a magnificent landscape or a holiday dinner with all the relatives at the table. Filter size is 52mm.

|  |       |                                    |       |
|--|-------|------------------------------------|-------|
| For Canon FD (PH2428C).....                      | 74.95 | For Contax/Yashica (PH2428CY)..... | 74.95 |
| For Minolta MD (PH2428M).....                    | 74.95 | For Nikon AI (PH2428N).....        | 74.95 |
| For Olympus OM (PH2428O).....                    | 74.95 | For Pentax K (PH2428P).....        | 74.95 |
| For Universal Screw Mount Cameras (PH2428U)..... | 74.95 |                                    |       |

### 28mm f/2.8 Wide Angle Lens

This is the most popular wide angle focal length. The 28mm lens can be used for scenes, group shots and interiors. It is perfect for the person who doesn't need the extra versatility of a zoom lens in the wide angle focal lengths. Filter size is 49mm.

|  |       |                                    |       |
|--|-------|------------------------------------|-------|
| For Canon FD (PH2828C).....                      | 64.95 | For Contax/Yashica (PH2828CY)..... | 64.95 |
| For Minolta MD (PH2828M).....                    | 64.95 | For Nikon AI (PH2828N).....        | 64.95 |
| For Olympus OM (PH2828O).....                    | 64.95 | For Pentax K (PH2828P).....        | 64.95 |
| For Universal Screw Mount Cameras (PH2828U)..... | 64.95 |                                    |       |

### 100mm f/3.5 Macro Lens

Whether you are an oral surgeon or just love to take close-ups of flowers, this lens features 1:2 macro without the included adapter and 1:1 with the adapter. It focuses down to an incredible 2.6" from the front of the lens. Filter size is 49mm.

|  |        |                                      |        |                                 |        |
|--|--------|--------------------------------------|--------|---------------------------------|--------|
| For Canon FD (PH10035MC).....                      | 119.95 | For Contax/Yashica (PH10035MCY)..... | 119.95 | For Minolta MD (PH10035MM)..... | 119.95 |
| For Nikon AI (PH10035MN).....                      | 119.95 | For Olympus OM (PH10035MO).....      | 119.95 | For Pentax K (PH10035MP).....   | 119.95 |
| For Universal Screw Mount Cameras (PH10035MU)..... | 119.95 |                                      |        |                                 |        |

### 500mm f/8 Lens

This incredibly compact and lightweight ultra-telephoto lens uses an advanced reflex design that is ideally suited for wildlife and sports photography. It has a fixed aperture of f/8 and comes complete with a soft pouch and three rear mounted 30.5mm filters (ND2x, ND4x and Skylight). Simple T-mount adapters screw on the lens and make this lens adaptable to fit almost any current or even discontinued camera.

|   |        |                                    |        |                               |        |
|---|--------|------------------------------------|--------|-------------------------------|--------|
| For Canon FD (PH5008C).....                       | 109.95 | For Contax/Yashica (PH5008CY)..... | 109.95 | For Minolta MD (PH5008M)..... | 109.95 |
| For Nikon AI (PH5008N).....                       | 109.95 | For Olympus OM (PH5008O).....      | 109.95 | For Pentax K (PH5008P).....   | 109.95 |
| For Universal Screw Mount Cameras (PH5008PU)..... | 109.95 |                                    |        |                               |        |

### 19-35mm f/3.5-4.5 Wide Angle Zoom Lens

A perfect, inexpensive choice for the user that needs the versatility of a wide angle zoom. Ideal for use at sporting events, family outings, or on vacations. A bayonet mount lens hood is included. Filter size is 77mm.

|  |        |                                      |        |
|--|--------|--------------------------------------|--------|
| For Canon FD (PH193535C).....                      | 139.95 | For Contax/Yashica (PH193535CY)..... | 139.95 |
| For Minolta MD (PH193535M).....                    | 139.95 | For Nikon AI (PH193535N).....        | 139.95 |
| For Olympus OM (PH193535O).....                    | 139.95 | For Pentax K (PH193535P).....        | 139.95 |
| For Universal Screw Mount Cameras (PH193535U)..... | 139.95 |                                      |        |

### 28-80mm f/3.5-5.6 Wide Angle Zoom Lens

Weighing only 8.3 oz., this small, compact lens is the perfect replacement for a standard 50mm lens. It covers the typical wide-angle to a moderate telephoto range while retaining the size and weight most desired in an everyday lens. Filter size is 58mm.

|  |       |                                      |       |
|--|-------|--------------------------------------|-------|
| For Canon FD (PH288035C).....                      | 84.95 | For Contax/Yashica (PH288035CY)..... | 84.95 |
| For Minolta MD (PH288035M).....                    | 84.95 | For Nikon AI (PH288035N).....        | 84.95 |
| For Olympus OM (PH288035O).....                    | 84.95 | For Pentax K (PH288035P).....        | 89.95 |
| For Universal Screw Mount Cameras (PH288035U)..... | Call  |                                      |       |





# PHOENIX

## MANUAL FOCUS LENSES

### 28-210mm f/3.5-5.6 High Power Wide Angle Zoom

A inexpensive lens that is ideal for everyday usage. The 28-210mm gives you the advantage of wide angle views as well as moderate telephoto views. Perfect for any type of photography wherever you may travel. Filter size is 72mm.

For Canon FD (PH2821035C) .....134.95 For Contax/Yashica (PH2821035CY) 134.95  
 For Minolta MD (PH2821035M) ....134.95 For Nikon AI (PH2821035N).....134.95  
 For Olympus OM (PH2821035O) ..134.95 For Pentax K (PH2821035P).....134.95  
 For Universal Screw Mount Cameras (PH2821035U) .....134.95

### 70-210mm f/4.5-5.6 Telephoto Zoom

This lens is the most popular telephoto zoom lens. Incredibly compact and light-weight, the 70-210mm is ideal for portaiture use. It also makes a great companion to the 28-80mm wide angle zoom lens. Filter size is 52mm.

For Canon FD (PH7021045C) .....89.95 For Contax/Yashica (PH7021045CY)...89.95  
 For Minolta MD (PH7021045M) .....89.95 For Nikon AI (PH7021045N) .....89.95  
 For Olympus OM (PH7021045O) ....89.95 For Pentax K (PH7021045P) .....89.95  
 For Universal Screw Mount Cameras (PH7021045U) .....89.95

### 100-300mm f/5.6-6.7 Super Telephoto Zoom

The 100-300mm tele-zoom lens is an inexpensive way to grab those far-away shots. Manufactured by using the latest technology, this lens is extremely lightweight and compact. Use this lens to zoom in on your favorite baseball player on the field at a ball game, the quarterback about to pass at a football game, your favorite tennis star or your child at a little league game. The opportunities are endless. Filter size is 55mm.

For Canon FD (PH10030056C).....109.95 For Contax/Yashica (PH10030056CY).109.95  
 For Minolta MD (PH10030056M) ..109.95 For Nikon AI (PH10030056N).....109.95  
 For Olympus OM (PH10030056O)..109.95 For Pentax K (PH10030056P).....109.95

### 100-500mm f/5.6-8.0 Super Telephoto Zoom

An ultra-telephoto zoom lens, the 100-500mm offers the outdoor photographer amazing versatility because of it's 5x zoom range. It goes from portrait length to extreme telephoto with one-touch ease. When you need to get up close but you physically can't, this is the lens to use. When comparing focal length, range, features and price, no other zoom lens comes close. It features a rotating tripod mount with locking knob. Includes a hard lens case. Filter size is 67mm.

For Canon FD (PH10050056C).....349.95 For Contax/Yashica (PH10050056CY)..349.95  
 For Minolta MD (PH10050056M) ..349.95 For Nikon AI (PH10050056N) .....349.95  
 For Olympus OM (PH10050056O).349.95 For Pentax K (PH10050056P) .....349.95  
 For Universal Screw Mount Cameras (PH10050056U).....349.95

### 650-1300mm f/8-16 Super Telephoto Zoom

This lens is the economical way to do extreme telephoto photography, up to 1300mm. The lens features a 650-1300mm zoom range, and has only one effective aperture at any focal length, which is variable from f/8 at 650mm to f/16 at 1300mm. This lens features a T-mount, and requires an appropriate T-mount camera adapter.

Available with a Canon FD T-Mount (PH6501300TC), Konica T-Mount (PH6501300TK), Minolta MD T-Mount (PH6501300TM), Nikon T-Mount (PH6501300TN), Olympus OM T-Mount (PH6501300TO), Pentax K T-Mount (PH6501300TP), Contax/Yashica T-Mount (PH6501300TCY), Pentax Universal T-Mount (PH6501300TPU), Canon EOS T-Mount (PH6501300TCE), or with Minolta Maxxum T-Mount (PH6501300TMM).....299.95  
 Without T-Mount (PH6501300T).....299.95



28-210mm  
f/3.5-5.6  
High Power  
Wide Angle Zoom

70-210mm f/4.5-5.6  
Telephoto Zoom

100-500mm  
f/5.6-8.0  
Super Telephoto  
Zoom

CAMERAS & LENSES

153

# PHOENIX

## AUTOFOCUS LENSES

CAMERAS & LENSES

154



100mm f/3.5  
Macro Lens



19-35mm  
f/3.5-4.5  
Wide Angle  
Zoom



28-105mm  
f/2.8-3.8  
Wide Angle  
Zoom Lens



28-300mm  
f/4.0-6.3  
High Powered  
Wide Angle  
Zoom Lens

### 100mm f/3.5 Macro Lens

Whether you are an oral surgeon or just love to take close-ups of flowers, this lens features 1:2 macro without the included adapter and 1:1 with the adapter. It focuses down to an incredible 2.6" from the front of the lens.

For Canon EOS (PH10035MCAF) .....169.95 For Nikon AF (PH10035MNAF) .....149.95  
For Minolta Maxxum (PH10035MMAF) ...149.95 For Pentax AF (PH10035MPAF) .....149.95

### 19-35mm f/3.5-4.5 Wide Angle Zoom Lens

A perfect, inexpensive choice for the user that needs the versatility of a wide angle zoom. Ideal for use at sporting events, family outings, or on vacations. A bayonet mount lens hood is included.

For Canon EOS (PH193535CAF) .....169.95 For Nikon AF (PH193535NAF) .....159.95  
For Minolta Maxxum (PH193535MAF) .....159.95 For Pentax AF (PH193535PAF) .....159.95

### 28-80mm f/3.5-5.6 Wide Angle Zoom Lens

Weighing only 8.3 oz., this small, compact lens is the perfect replacement for a standard 50mm lens. It covers the typical wide-angle to a moderate telephoto range while retaining the size and weight most desired in an everyday lens.

For Canon EOS (PH288035CAF) .....79.95 For Nikon AF (PH288035NAF) .....69.95  
For Minolta Maxxum (PH288035MAF) .....69.95 For Pentax AF (PH288035PAF) .....69.95

### 28-105mm f/2.8-3.8 Wide Angle Zoom Lens

This autofocus Phoenix lens is the perfect, inexpensive, lightweight lens for all-around use. Because of the fast aperture, it is great even in lower light conditions. Take it on vacations, sports events or family outings. Bayonet mount lens hood is included.

For Canon EOS (PH2810528CAF) .....169.95 For Nikon AF (PH2810528NAF) .....159.95  
For Minolta Maxxum (PH2810528MAF) .....159.95

### 28-210mm f/3.5-5.6 High Power Wide Angle Zoom

A inexpensive lens that is ideal for everyday usage. The 28-210mm gives you the advantage of wide angle views as well as moderate telephoto views. Perfect for any type of photography wherever you may travel.

For Canon EOS (PH2821035CAF) .....159.95 For Nikon AF (PH2821035NAF) .....149.95  
For Minolta Maxxum (PH2821035MAF) .....149.95

### 28-210mm f/4.2-6.5 Aspherical IF Zoom

This lens features aspherical elements to produce extra sharp pictures with almost no distortion. It also features "internal focusing" so that the lens does not rotate on the front when focusing, a helpful feature when using a polarizer filter and it's unique (included) lens hood.

For Canon EOS (PH2821042CAF) .....189.95 For Nikon AF (PH2821042NAF) .....179.95  
For Minolta Maxxum (PH2821042MAF) ...179.95 For Pentax AF (PH2821042PAF) .....179.95

### 28-300mm f/4.0-6.3

#### High Powered Wide Angle Zoom Lens

The Phoenix AF 28-300mm lens is your do-it-all lens. If you have only one lens, this is the one to have. The incredible range gives you everything from wide vistas to cropped in telephoto shots for sports or perfect candid of wild animals.

For Canon EOS (PH283004CAF) .....199.95 For Nikon AF (PH283004NAF) .....189.95  
For Minolta Maxxum (PH283004MAF) .....189.95



EQUIPMENT LEASING AVAILABLE

# PHOENIX

## AUTOFOCUS LENSES

### 70-210mm f/4.5-5.6 Telephoto Zoom

This lens is the most popular telephoto zoom lens. Incredibly compact and lightweight, the 70-210mm is ideal for portaiture use. It also makes a great companion to the 28-80mm wide angle zoom lens.

For Canon EOS (PH7021045CAF) .....99.95 For Nikon AF (PH7021045NAF) .....99.95  
 For Minolta Maxxum (PH7021045MAF) .....99.95

### 100-300mm f/5.6-6.7 Telephoto Zoom

The 100-300mm tele-zoom lens is an inexpensive way to grab those far-away shots. Manufactured by using the latest technology, this lens is extremely lightweight and compact. Use this lens to zoom in on your favorite baseball player on the field at a ball game, the quarterback about to pass at a football game, your favorite tennis star or your child at a little league game. The opportunities are endless.

For Canon EOS (PH10030056CA) .....129.95 For Nikon AF (PH10030056NA) .....114.95  
 For Minolta Maxxum (PH10030056MA) ...114.95 For Pentax AF (PH10030056PA) .....114.95

### 100-400mm f/4.5-6.7 Telephoto Zoom

Take this lens on your next safari, or to the zoo with the kids. Focus on your subject, come in tight for detail and catch the unexpected. If you're at a sports event or standing on top of a mountain, you can focus out to infinity and still get breathtaking results. Getting spectacular zoom-effect shots takes a super tele-zoom like this 100-400mm lens and just a little creativity. Bayonet mount lens hood is included.

For Canon EOS (PH10040045CA) .....209.95 For Nikon AF (PH10040045NA) .....189.95  
 For Minolta Maxxum (PH10040045MA) ...189.95 For Pentax AF (PH10040045PA) .....209.95



CAMERAS & LENSES

155

## FLASHES



### RL-59C TTL Macro Ringlight Flash

With unbelievable power for the price, the RL-59 series of ringlight flashes from Phoenix delivers. Made for each specific autofocus camera, they give full TTL metering to allow accurate exposures of closeup subjects. When shooting at extremely short distances, relatively minor movement of lighting and subject results in relatively large changes of exposure. Shooting quick-moving subjects in rapidly changing conditions becomes an exercise in dependency on film latitude. TTL metering eliminates the need for lengthy calculations of exposure, because the inherent loss of light at macro distances can automatically be accounted with ease.

RL-59C for Canon EOS (PHRLCAF) .....89.95  
 RL-59C for Minolta Maxxum (PHRLMAF) .....89.95

RL-59C for Nikon AF (PHRLNAF) .....89.95  
 RL-59C for Pentax AF (PHRLPAF) .....89.95

### Phoenix 66S Pro Slave Manual Handle Mount Flash (PH66S)

The PH-66 is a handle mount flash ideal for use with point and shoot cameras. There is no need to connect the flash and camera because the unit has a built-in slave system. Of course, a PC cord can also be used when you have a camera equipped with a PC terminal .....39.95

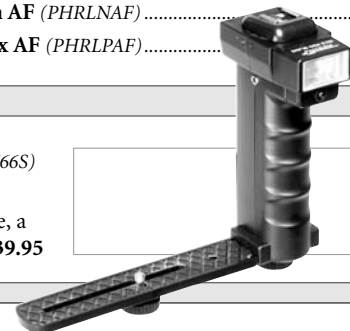

ORDER & INFO. (212) 502-6340 • FAX: (212) 239-7770 (800) 947-7008  
 1-800-290-6750 • www.bhphotovideo.com



# SIGMA

## SA-7/SA-9QD

### 35mm Autofocus SLRs

*Sigma's AF SLR cameras, the SA-7 and SA-9QD provide the right mix of features for great photographic versatility, in compact, lightweight camera bodies. Together with Sigma's comprehensive system of lenses, flash and accessories, they can fulfill almost any photographic need, while maintaining simplicity of design and operation.*

*They feature automatic and manual exposure control, as well as automatic and manual focus capabilities. In addition they feature a stainless steel lens-mount, built-in flash with red-eye reduction, automatic film handling, three metering systems, multiple auto exposure modes including a shiftable program exposure mode, AE Lock, auto-exposure bracketing, depth-of-field preview, mirror lock-up capability, 3-channel wireless remote control receiver, and wireless TTL control flash (with optional EF500 DG Super or EF500 Super flash units). The SA-7 features a high-speed shutter of 1/2000 and flash sync 1/90 of a second. Continuous shooting of up to 1.5 fps (frames-per-second) is possible. Otherwise identical, the high performance SA-9 QD steps up with action-stopping shutter (1/8000) and flash sync (1/180) speeds, high speed 3 fps shooting and a built-in databack.*



### FEATURES

#### Precise Autofocus

- ◆ Using AF-cross sensor in the center of the viewfinder, they feature fast, easy and precise autofocusing capability. You simply set the point of focus on any selected part of a subject while looking through the viewfinder. The AF-cross sensor does the rest offering excellent tracking capability and the ability to focus multiple subject types. Your pictures will never be out of focus.
- ◆ There are two focus modes to match shooting purpose and subject:
  - Single AF mode with a “focus” indicator light in the viewfinders along with an electronic sound to indicate correct focus.
  - Continuous AF mode when shooting a subject moving at constant speed, such as sporting events or people marching in a parade.
- ◆ A predictive AF function in the Continuous AF mode ensures optimum focus when taking pictures of subjects moving towards or away from you at constant speed. It will latch onto subjects between infinity and 26.4 feet moving as fast as 30 miles per hour.

#### Three Metering Systems

- ◆ 8-Segment Evaluative Metering: When selected this mode divides the image into 8 parts, and the light intensity of each segment is measured independently. An optimum exposure is calculated based on the information obtained by this metering.
- ◆ Center Area Metering: In this mode, the light intensity of an area (about 9mm in diameter at the center of the viewfinder) is measured so that you can select an exposure value to obtain the intended image. Since the light intensity is detected only at the center of the viewfinder, this mode lets you eliminate the effects of surrounding light sources when setting the exposure.
- ◆ Average Metering: This mode measures the light intensity at the center of the viewfinder image, but also takes the brightness of the surrounding area into consideration. This is the most common metering mode. When used with the exposure compensation function, this mode provides effective exposure control, according to the type of subject being photographed.

#### Exposure Modes

- ◆ The dial for adjusting shutter speed and the selector for setting exposure mode are positioned together for smooth and reliable operation.
  - Program Auto (P): In this mode, the cameras automatically set the shutter speed and aperture, enabling quick shooting.
  - Shiftable Program mode lets you enjoy the creative benefits of aperture- or shutter-priority without having to change exposure modes. While in P mode you can quickly shift the programmed autoexposure setting to a desired aperture or shutter speed without affecting the original exposure
  - In Aperture-priority mode you select the aperture and the cameras set the optimum shutter speed.
  - In Shutter-priority you select the shutter speed and the cameras sets the correct aperture value.
  - In Manual mode you select both the aperture and shutter speed in any combination.



# SIGMA

## SA-7/SA-9QD

### Preview Button

- ◆ Pressing the Preview button adjusts the lens aperture to the value set, allowing you to check the depth of field of the intended image. The Preview function also lets the photographer confirm the

### Dioptr Compensation

- ◆ Diopter compensation function enables dioptic adjustment of the viewfinder to suit individual users. This makes the viewfinder image easier to see, facilitating image composition setting.

### Mirror Lock-Up

- ◆ The Mirror Lock-up function opens the shutter after vibration caused by flipping the mirror up stops, to ensure image sharpness. This function is especially useful when using a super-long telephoto lens to take scenic shots.
- ◆ Use the RS-21 Remote Control with the Mirror Lock-up function to ensure blur-free pictures, unaffected by mirror impact. The remote also lets you operate the shutter away from the camera. This is ideal for taking self-portraits, family pictures, etc. (The RS-21 has three channels to prevent interference with other SA cameras being operated by remote control nearby.)



### Exposure Control

- ◆ When shooting in tricky lighting situations such as high-contrast scenes, snowy landscapes, or dark shadows, you can use exposure compensation or bracketing to ensure you get the exposure that best renders the scene. With the SA-7 and SA-9D, exposure can be compensated up to  $\pm 3$  EV in 0.5 increments.
- ◆ In addition, the Auto Bracket function allows continuous shooting of images at three different exposure levels (standard, under- and over-exposure).
- ◆ Multiple exposure function allows the creation of dazzling, surreal effects by recording up to nine images on a single frame of film.



### Built-in Flash

When flash is required for indoor shooting due to insufficient light, the flash indicator in the viewfinder blinks. The cameras have a built-in flash that employs a TTL auto light control system covering a 28mm lens with a Guide Number of 40/ft ISO 100. Flash modes include red-eye reduction.

### Internal Motor (HSM-equip) for High-Speed Noiseless AF

An AF internal lens motor drive ensures ideal focusing operation for more than 40 different types of Sigma lenses including hypersonic motor (HSM) lenses. Use of Sigma lenses equipped with a hypersonic motor (HSM) ensures high speed focusing with minimal operating sound.

### Convenient Controls and Displays

- ◆ The Command Dial is located near the shutter button. The Command Dial allows the setting of various functions when used in combination with other dials or function buttons. It minimizes operating errors and ensures precise control.
- ◆ The Drive dial is used for fine adjustment when taking pictures. Simply turning the dial easily sets both the Mirror Lock-up function and high-speed film advance. The Drive dial is designed to simplify operation for users.
- ◆ The dial for adjusting shutter speed and the selector for setting the exposure mode are located near one another. Designed with users in mind, these controls provide easy, reliable control of camera operations.
- ◆ The viewfinder displays a variety of information in easy-to-read characters and color, to assist photographers. You don't have to look away to obtain the necessary information. When used with the diopter compensation function, the viewfinder ensures the optimum diopter setting for every user.
- ◆ The LCD panel on top of the cameras display a variety of shooting information. These include low-battery warning, flash mode, metering mode, film counter, etc.
- ◆ Equipped with two- and ten-second self-timer modes. The 10-second self-timer mode is suitable for family pictures. The 2-second timer can be used instead of a cable release shutter mechanism, to help minimize vibration.

## SA-7 vs. SA-9QD COMPARISON

|                            | SA-7  | SA-9QD   |
|----------------------------|---|--|
| Shutter Speeds             | 30 sec. to 1/2000, B  | 30 sec. to 1/8000 plus B   |
| Program/Aperture Priority  | 1/2000 to 30 sec.   | 1/8000 to 30 sec.  |
| Shutter Priority           | 1/2000 to 4 sec.  | 1/8000 to 30 sec.  |
| Manual Mode                | 1/2000 to 4 sec.  | 1/8000 to 30 sec.  |
| Film Advance               | 1.5 frames per second   | 3 frames per second  |
| External Flash Sync        | Hot shoe (contact X, synchronized at 1/90-sec. or less, with dedicated flash linking contact), synchronization with high shutter speeds of up to 1/2000-sec. when using EF-500 Super in FP flash mode | Hot shoe (contact X, synchronized at 1/180-sec. or less, with dedicated flash linking contact), synchronization with high shutter speeds of up to 1/8000-sec. when using EF-500 Super in FP flash mode |
| Databack                   | —   | Built-in   |
| Dimensions (WxHxD)         | 5.2 x 3.6 x 2.7"  | 5.6 x 3.8 x 2.7"   |
| Weight (excluding battery) | 13.9 oz.  | 15.3 oz.   |

# SIGMA

## SA-7/SA-9QD

### SA-7 & SA-9QD PRICING

**SA-7 Body (SISA7)**  
Includes a wide strap and two CR2 3v lithium batteries.....**179.95**

**SA-7 Kit (SISA72LK)**  
Includes an SA-7 body, 28-80mm and 70-300mm lenses and a gadget bag.....**349.95**

**SA-9 QD Body with Date (SISA9D)**  
Includes a wide strap and one 2CR5 6v lithium battery .....**299.95**

**SA-9 QD Kit (SISA9D2LK)**  
Includes an SA-9QD body, 28-80mm and 70-300mm lenses and a gadget bag.....**399.95**

## FLASHES

### EF-500 DG ST / EF-500 DG Super *Advanced Flash Photography*

Sigma EF-500 series flashes provide large quantities of light with complete control of the camera (Canon, Nikon, Pentax, Minolta or Sigma). They feature high guide numbers and full TTL exposure automation, with simple operation. Powerful shoe-mount flashes, each is designed to compliment the capabilities of the 35mm SLR camera for which it is intended.

The standard (ST) model features full exposure automation, full auto-zoom function and ease of operation. The Super model has the same power and automation, but steps up with more user control and creative functions, including wireless TTL exposure control, high speed (FP) synchronization, distance information functions, modeling light, slave functions and more.



- ◆ They provide a large amount of light, featuring a guide number of 165/ft with ISO 100.
- ◆ Autozoom function automatically sets the illumination angle in accordance with the focal length of the lens (from 28mm to 105mm)
- ◆ Built-in wide angle diffuser covers angle of view down to 17mm
- ◆ The flash head can be tilted by up to 90°, to the left by 180°, or to the right by 90°. It can also be tilted down by 7° for close-up shots.
- ◆ They run on four AA alkaline or NiMH batteries

**EF-500 DG ST Flash:**

For Minolta (SIEF500DGSTM), Pentax AF (SIEF500DGSTP), Sigma SA (SIEF500DGSTS), Canon EOS (SIEF500DGSTC) and Nikon AF (SIEF500DGSTN) ....**149.95**

### EF-500 DG Super *Step-up Features*

- ◆ Wireless slave function enables the control of multiple EF-500 DG Super flashes while preserving the automatic TTL control function
- ◆ “Modeling flash” mode provides proper light distribution to check the shadow of the subject.
- ◆ Multi pulse flash enables reduced power setting from 1/4 to 1/128 and the interval time of the flash can be set from 1Hz to 199Hz.
- ◆ FP flash which is capable of synchronizing the flash illumination with high shutter speeds, and the rear curtain synchro flash which allows delayed synchro photography.

**EF-500 DG Super:**

For Sigma (SIEF500DGSS), Nikon (SIEF500DGSN), Minolta (SIEF500DGSM), Pentax (SIEF500DGSP) and Canon EOS (SIEF500DGSC).....**199.95**

### EM-140 DG TTL Macro Ringlight Flash



Designed for close-up photography the EM-140 DG Ring Flash is extremely effective for scientific and medical applications. Dual flash tubes can fire simultaneously or separately. Using only one flashtube creates modeling, which can give a three-dimensional feeling to the subject. The Modeling Flash function makes it possible to check for reflections and shadows before actually taking the

flash picture. A wireless flash function is also available, where the EM-140 DG is used as master and the EF-500 DG Super as a slave unit for creating fine shadow details. High Speed Synchro and exposure compensation functions are also available for advanced flash photography.

**EM-140 DG:** For Sigma SA (SIEM140DGS), Canon EOS (SIEM140DGC) and Nikon AF (SIEM140DGN).....**349.00**



**EQUIPMENT LEASING AVAILABLE**

# SIGMA

## AF LENSES FOR CANON, MINOLTA, NIKON, PENTAX & SIGMA

### AF Lenses for Canon, Minolta, Nikon, Pentax and Sigma

As the world's largest independent manufacturer of zoom and fixed focal length lenses, Sigma offers a highly innovative and creative selection of lenses ranging from 8mm to 800mm and virtually everything in between. The lenses offer a high level of performance, easy handling and advanced optical precision to create profound and emotional images. Sigma lenses are built with corresponding mounts to make them fully compatible with the SA-7 and SA-9QD as well as digital cameras from Canon, Minolta, Nikon and Pentax.

In addition, Sigma offers a number of lenses designed specifically for digital SLR cameras, which can also be used with 35mm SLRs. They are mostly wide-angle and wide zoom type lenses with large apertures (e.g. 20mm f/1.8, 24mm f/1.8, 28mm f/1.8, 24-70mm f/2.8, 15-30mm f/3.5-4.5), and feature superior light distribution, so that there is minimal light fall-off or vignetting, even when used at maximum aperture.

These lenses are designated DG type, and are part of Sigma's EX series of lenses. Remember that the digital imaging device is generally much smaller than a 35mm negative, so the lens will have a longer "effective" focal length. The conversion factor is generally about 1.5x, so a 14mm lens effectively becomes about 21mm when used on these digital cameras. As a result, there are few choices available for wideangle lenses, or even fast "normal" lenses, for these digital cameras. The DG lenses help fill this void.



CAMERAS & LENSES

159

### ULTRA WIDE-ANGLE LENSES

#### 8mm f4 EX Circular Fisheye

This circular image focus fisheye lens captures a 180° view in all directions in a 22.08mm circle. In addition, it is useful for technical applications with solid angle measurement, such as the angle of view through the window with driver in the car or the pilot in the cockpit of an airplane. It accepts removable gelatin filters in a holder near the rear of the lens. The optical materials used are lead and arsenic free ecological glass.

For Canon (SI84CAF) .....609.00 For Nikon (SI84NAF) .....609.00  
 For Minolta (SI84MAF) .....609.00 For Sigma SA (SI84SA) ...609.00 For Pentax AF (SI84PAF).....609.00



#### 14mm f2.8 EX Aspherical

The world's shortest focal length non-fisheye wide-angle AF lens with a fast f2.8 maximum aperture and a close focusing distance of only 7.1". The lens also incorporates a built-in "Perfect-Hood" lens hood and a gelatin filter holder behind the rear lens element. The AF drive for Nikon and Canon feature the ultra-quiet Hyper Sonic Motor (HSM). Includes padded case.

For Canon (SI1428ACAF).....899.00 For Nikon (SI1428ANAF) .....899.00  
 For Minolta (SI1428AMAF) .....899.00 For Sigma SA (SI1428ASA) .....899.00  
 For Pentax AF (SI1428APAF) .....899.00

ORDER & INFO. (212) 502-6340 • FAX: (212) 239-7770 (800) 947-7008  
**1-800-290-6750 • www.bhphotovideo.com**



# SIGMA

## AF LENSES FOR CANON, MINOLTA, NIKON, PENTAX & SIGMA

CAMERAS & LENSES

160

### WIDE-ANGLE LENSES

#### 15mm f2.8 EX Diagonal Fisheye

This is a full-frame fisheye auto focus lens that fills the entire 35mm negative with a full 180° diagonal field of view. This unique lens enables you to create a variety of unusual compositions even when shooting ordinary subjects. It accepts gelatin filters in a holder near the rear of the lens. Includes padded case and built-in "Perfect-Hood" lens hood.

For Canon (SI1528CAF) .....469.00      For Nikon (SI1528NAF) .....469.00  
 For Minolta (SI1528MAF) .....469.00      For Sigma SA (SI1528SA) .....469.00  
 For Pentax AF (SI1528PAF) .....469.00



#### 20mm f1.8 EX DG Aspherical RF



A super wide-angle lens with an angle of view 94.5°. It has macro focusing with a minimum focusing distance of 7.9" (reproduction ratio 1:4). An aspherical lens element in both the front and in the rear lens groups minimizes distortion, aspherical aberration and astigmatism. It has non-vignetting optical construction, in order to obtain adequate peripheral brightness even with open aperture. It incorporates a rear focus system eliminating front lens rotation. Dual-focus mechanism makes it easy to hold the lens, since the focusing ring does not rotate during auto-focus, yet it provides adequate focusing torque during manual focusing. Includes "Perfect-Hood" lens hood and case. Filter Size: 82mm.

For Canon (SI2018CAF) .....409.00      For Nikon (SI2018NAF) .....409.00  
 For Minolta (SI2018MAF) .....409.00      For Sigma SA (SI2018SA) .....409.00  
 For Pentax AF (SI2018PAF) .....409.00

#### 24mm f1.8 EX DG Aspherical Macro

This fast wide angle lens incorporates non-vignetting optical construction in order to obtain adequate peripheral brightness even at open aperture. This makes it desirable for digital cameras. The lens also has macro focusing capability down to 7.1", while the 9-bladed iris obtains beautiful out of focus images. The lens incorporates the floating focus system and uses two aspherical lens elements for minimizing distortion, spherical aberration and astigmatism. Internal focus system eliminates front lens rotation allowing the use of a "Perfect Hood" and polarizing filters. Dual-focus mechanism makes it easy to hold the lens, since focusing ring does not rotate during auto-focus, yet it provides adequate focusing torque during manual focusing. Includes reversible lens hood and padded soft case. Filter size: 77mm.



For Canon (SI2418MCAF) .....339.00      For Minolta (SI2418MMAF) .....339.00  
 For Nikon (SI2418MNAF) .....339.00      For Sigma SA (SI2418MSA) .....339.00      For Pentax AF (SI2418MPAF) .....339.00

#### 28mm f1.8 EX DG Aspherical Macro



Almost identical to the 24mm f/1.8, the compact 28mm f1.8 EX DG (3.1" long) also incorporates minimum vignetting optical construction to ensure adequate peripheral brightness with open aperture, making it desirable for digital cameras. The lens focuses down to 7.9" in macro mode, while the 9-bladed iris obtains beautiful out of focus images. In addition, the lens is equipped with two aspherical lens elements, internal focus system and dual-focus mechanism. A "perfect hood" shields the lens to prevent ghosting and internal reflection. Includes reversible lens hood and padded soft case. Filter size: 77mm.

For Canon (SI2818MCAF) .....269.00      For Nikon (SI2818MNAF) .....269.00  
 For Minolta (SI2818MMAF) .....269.00      For Sigma SA (SI2818MSA) .....269.00  
 For Pentax AF (SI2818MPAF) .....269.00





## AF LENSES FOR CANON, MINOLTA, NIKON, PENTAX & SIGMA

### MACRO LENSES

#### 50mm f2.8 EX DG Macro

To maintain high optical performance from infinity to close-up 1:1 macro photos without accessories, the Sigma 50mm f/2.8 EX DG incorporates a "Floating Internal Focusing" (FIF) system. As a result, the lens also features a non-rotating front lens group which makes it easier to work with polarizing filters, and has a focus limiter to narrow down the broad focus range. Plus, the improved minimum aperture of f/45 provides improved depth of field. This lens is designed as a high-quality primary macro lens, good for film or digital SLR cameras. The improved DG lens design corrects for various aberrations. This macro lens is specially coated to get the best color balance while cutting down on ghosting caused by reflections from the digital image sensor. Filter Size: 55mm.



For Canon (SI5028MDGCAF).....269.00      For Nikon (SI5028MDGNAF).....269.00  
 For Minolta (SI5028MDGMAF).....269.00      For Sigma SA (SI5028MDGSA).....269.00      For Pentax (SI5028MDGPAF).....269.00



#### 105mm f2.8 EX DG Macro

This macro lens delivers superb, distortion-free images throughout its broad focus range, from infinity telephoto to lifesize (1:1) macro, as close as 12.2" without accessories. Its non-rotating front lens group makes it easier to work with polarizing filters. A focus limiter helps divide the broad focus range into more manageable chunks. The "focus-free" mechanical design allows the lens to autofocus without any interference from the manual focus ring. Rugged construction makes it durable for even the heaviest use required by professional photographers. The improved DG lens design corrects various aberrations. This lens is coated to get the best color balance while cutting down on ghosting. Filter Size: 58mm.

For Canon (SI10528MDGCA).....399.00      For Nikon (SI10528MDGNA).....399.00  
 For Minolta (SI10528MDGMA).....399.00      For Sigma SA (SI10528MDGSA).....399.00      For Pentax (SI10528MDGPA).....399.00

#### 150mm f2.8 EX APO DG Macro/HSM

A super compact and lightweight large aperture telephoto lens, with life-size macro capability. To maintain high optical performance from infinity to close-up 1:1 macro photos without accessories, it incorporates a "Floating Internal Focusing" (FIF) system. As a result, the lens also features a non-rotating front lens group which makes it easier to work with polarizing filters. The AF drive for Canon and Nikon feature the ultra-quiet Hyper Sonic Motor (HSM). This DG lens design corrects various aberrations and provides the utmost correction against lateral chromatic aberration. Filter Size: 72mm.



For Canon (SI15028ACAF).....629.00      For Nikon (SI15028ANAF).....629.00  
 For Minolta (SI15028AMAF).....629.00      For Sigma SA (SI15028ASA).....629.00      For Pentax (SI15028APAF).....629.00



#### 180mm f3.5 EX APO Macro/HSM

This lens can focus from infinity to full 1:1 life-size from 18" away, making it ideal for shooting small animals or insects, etc. Apochromatic design and two SLD glass elements, plus floating inner focus system effectively control chromatic and spherical aberrations providing superb performance throughout the focusing range. Also features a focus limiter. Canon and Nikon mounts employ HSM for quiet, responsive AF function plus "full time" manual focus. Includes lens hood and case. Filter Size: 72mm.

For Canon (SI18035ACAF).....689.00      For Nikon (SI18035ANAF).....689.00  
 For Minolta (SI18035AMAF).....689.00      For Sigma SA (SI18035ASA).....689.00      For Pentax (SI18035APAF).....689.00

# SIGMA

## AF LENSES FOR CANON, MINOLTA, NIKON, PENTAX & SIGMA

### SUPER TELEPHOTO LENSES

#### 300mm f2.8 APO EX/HSM

A compact Apochromatic telephoto lens with a fast f2.8 maximum aperture. It incorporates two Extraordinary Low Dispersion (ELD) glass elements to reduce chromatic aberration to a minimum. It incorporates internal focusing which enables responsive and fast auto focus speed. The AF drive for Canon and Nikon feature the ultra-quiet Hyper Sonic Motor (HSM). Includes a detachable tripod socket, rotatable drop-in filter holder, lens hood, padded carry case with strap, normal filter and circular polarizing filter. Filter Size: 46mm rear drop-in.

For Canon (SI30028AEXCA).....2599.00      For Nikon (SI30028AEXNA) .....2599.00  
 For Minolta (SI30028AEXMA) .....2599.00      For Sigma SA (SI30028AEX) .....2599.00  
 For Pentax AF (SI30028AEXPA).....2599.00



#### 500mm f4.5 APO EX/HSM

Ultra-telephoto lens with a fast F4.5 maximum aperture, this lens incorporates two ELD glass elements to reduce chromatic aberration to a minimum. Internal focusing enables responsive and fast auto focus speed. The AF drive for Canon and Nikon features Sigma's ultra-quiet Hyper Sonic Motor (HSM). Very rugged, the lens also offers a host of conveniences including a built-in grip, rotating filter drawer, and tripod mount. Includes a lens hood, soft padded case, normal and circular polarizer rear drop-in filters and a front cover. Filter Size: 46mm rear drop-in.

For Canon (SI50045ACAFD) .....3249.00      For Nikon (SI50045ANAFD) .....3249.00  
 For Minolta (SI50045AMAF) .....3249.00      For Sigma SA (SI50045ASA).....3249.00      For Pentax (SI50045APAF) .....3249.00

#### 600mm f8.0 Mirror

"Mirror" lenses refer to systems comprised of reflecting mirrors with lenses, a combination that allows telephotos to be lighter and more compact than conventional lenses. The effect on the image is ring blur — great for portrait work. The beauty is heightened even more when lighting is effectively used in shooting, resulting in photographs with overwhelming emotive power. Characteristics that make this lens a true classic. This improved model delivers better performance at close range with increased peripheral light. The use of rear-insertion type filters enable rapid secure filter changes. The barrel's rugged ZEN finish helps it withstand hard outdoor use.

For Canon (SI6008CAF) .....399.00      For Minolta (SI6008MAF) .....399.00  
 For Nikon (SI6008NAF).....399.00      For Sigma SA (SI6008SA)...399.00      For Pentax (SI6008PAF) ....399.00



#### 1.4x and 2x EX APO Tele-Converters

Sigma's tele extender lenses can be used with fixed focal length lenses as well as most zoom lenses. Optically superb, they preserve the image quality of the lens their mounted to while multiplying their focal length by 1.4x or 2x. However, effective aperture is reduced by one f-stop and two f-stops respectively. (Note: call or check the B&H website for compatible lenses!)



1.4x APO for Canon (SI1.4XCAF) .....169.00      2x APO for Canon (SI2XCAF).....189.00  
 1.4x APO for Nikon (SI1.4XNAF) .....169.00      2x APO for Nikon (SI2XNAF) .....189.00  
 1.4x APO for Minolta (SI1.4XMAF)...169.00      2x APO for Minolta (SI2XMAF) .....189.00  
 1.4x APO for Pentax (SI1.4XPAF) .....169.00      2x APO for Pentax (SI2XPAF).....189.00  
 1.4x APO for Sigma SA (SI1.4XSA) ...169.00      2x APO for Sigma SA (SI2X) .....189.00

## AF LENSES FOR CANON, MINOLTA, NIKON, PENTAX & SIGMA

### ULTRA-WIDE ANGLE ZOOM LENSES

#### 12-24mm f4.5-5.6 EX DG Aspherical/HSM

This lens has a large angle of view (122° super wide angle of view at 12mm along the diagonal axis) making it ideal for shooting indoors as well as outdoor landscape photography. It has a variable angle of view from 122° to 84.1°. It is equipped with four Special Low Dispersion (SLD) glass elements for effective compensation of color aberration which is a common problem with super wide-angle lenses. Three pieces of aspherical lenses offer excellent correction for distortion as well as all types of aberration for a high level of optical performance. Inner focusing system ensures the length of the lens remains unchanged while controlling aberration. By effective arrangement of lens elements and advanced technology the lens has super compact dimensions of 100mm full-length, and 87mm maximum diameter. Minimum focusing distance of 28" at all focal lengths. The lens is equipped with an integral petal-type hood to block out extraneous light. Rear gelatin filter slot.



For Canon (SI122445CAF).....709.00 For Nikon (SI122445NAF) .....709.00  
 For Minolta (SI122445MAF) .....709.00 For Sigma SA (SI122445SA) .....709.00 For Pentax (SI122445PAF) .....709.00



#### 15-30mm f3.5-4.5 EX Aspherical DG DF

This rectilinear lens has a minimum focusing distance of 11.8" at all focal lengths. A hybrid aspherical lens in the front lens group minimizes distortion and astigmatism, while molded glass aspherical lens in the rear group minimizes spherical aberration. 8-blade diaphragm achieves beautiful out of focus images in the foreground and background. Dual focus mechanism and inner focusing system makes it easy to hold. Includes non-removable "Perfect-Hood" and uses rear gelatin filters. Used on most digital SLR cameras, the effective zoom will be 22.5-45mm. Includes a padded case. 82mm filter size.

For Canon (SI153035CAF) .....619.00 For Nikon (SI153035NAF).....619.00  
 For Minolta (SI153035MAF) .....619.00 For Sigma SA (SI153035SA).....619.00  
 For Pentax (SI153035PAF) .....619.00

#### 17-35mm f2.8-4 EX DG/HSM

The 17-35mm EX DG/HSM lens covers a super wide-angle range and has improved closer focusing over its predecessor. It is equipped with the Inner Focusing system that will keep the length of the lens unchanged while controlling aberration. The models which are equipped with HSM system (available for Sigma, Canon and Nikon camera mount lens) offer Full Time Manual Focusing. SLD (Special Low Dispersion) Glass is used for effective compensation of color aberration. Filter size: 77mm.



For Canon (SI173528DCAF).....499.00 For Nikon (SI173528DNAF) .....499.00  
 For Minolta (SI173528DMAF).....499.00 For Sigma SA (SI173528DSA) .....499.00  
 For Pentax (SI173528DPAF) .....499.00



#### 20-40mm f2.8 EX Aspherical DG DF

The 20-40mm f2.8 EX provides a large maximum aperture for all focal lengths. The lens has minimum focus distance of 11.8 inches at all focal lengths and maximum magnification is 1: 4.6. It incorporates aspherical lenses in the front and rear lens group to minimize distortion, astigmatism and spherical aberration. Equipped with a Dual Focus and Inner Focus mechanism. Designed for digital SLR cameras, includes a removable petal shaped hood to prevent extraneous light

For Canon (SI204028CAF).....479.00 For Nikon (SI204028NAF) .....479.00  
 For Minolta (SI204028MAF).....479.00 For Sigma SA (SI204028SA) .....479.00  
 For Pentax (SI204028PAF) .....479.00

# SIGMA

## AF LENSES FOR CANON, MINOLTA, NIKON, PENTAX & SIGMA

### WIDE ANGLE ZOOM LENSES



#### 24-60mm f2.8 EX DG

A very compact design for a lens with this large an aperture. By effective arrangement of Special Low Dispersion (SLD) and aspherical glass elements, this lens has compact dimensions of 3.29" maximum diameter, and 33.2" length. In addition, features like IF (Internal Focusing) and a Zoom Lock switch make it a high performance zoom lens ideal for everyday or traveling use. The DG lens coating reduces flare and ghosting and creates optimum color balance. Filter size: 77mm.

For Canon (SI246028CAF) .....419.00 For Nikon (SI246028NAF) .....419.00  
 For Minolta (SI246028MAF) ..419.00 For Sigma SA (SI246028SA)419.00 For Pentax (SI246028PAF) .....419.00

#### 24-70mm f2.8 EX Aspherical DG DF

This fast lens covers ultra wide-angle to medium telephoto while providing a large f2.8 aperture at all focal lengths. It employs three aspherical lens elements to minimize spherical aberration, astigmatism and sagittal coma flare. It has two SLD glass elements to correct chromatic aberration and achieve a high level of optical performance. It also incorporates a Dual Focus mechanism. Since the front of the lens does not rotate, it allows use of polarizing filters. Includes "Perfect-Hood" and a padded soft case. Filter size: 82mm.

For Canon (SI247028DGCA) .....439.00 For Nikon (SI247028DGNA) .....439.00  
 For Minolta (SI247028DGMA) .....439.00 For Sigma SA (SI247028DGSS) .....439.00  
 For Pentax (SI247028DGPA) .....439.00



#### 24-70mm f3.5-5.6 Aspherical HF

Employing a Helical Focusing system (HF) for focus adjustment, the front of this lens doesn't rotate allowing the use of polarizing filters. Minimum focusing distance to subject at all focal lengths is 15.7". Aspherical lens elements minimize distortion, spherical aberration and astigmatism, resulting in high image contrast and resolution. A depth of field scale helps in determining the subject's depth of field at a specific focal length and distance. Includes "Perfect-Hood" lens hood. Filter size: 62mm.

For Canon (SI247035CAF) .....129.00 For Nikon (SI247035NAF) .....129.00  
 For Minolta (SI247035MAF) ...129.00 For Sigma SA (SI247035SA)119.00 For Pentax (SI247035PAF) .....129.00

#### 24-135mm f2.8-4.5 Aspherical IF

This lens achieves a large aperture from a wide angle of view more than 80° at 24mm to standard 135mm zoom. A Special Low Dispersion (SLD) glass element and two aspherical lenses optimizes optical performance. At 24mm focal length this lens has a fast F2.8 maximum aperture. This lens has a super wide range of angles of view from 84.1 to 18.2°. It incorporates an internal focusing system, which eliminates front lens rotation, allowing use of polarizing filters and petal-type hoods. The lens materials used in this lens are lead and arsenic-free ecological glass. Filter size: 77mm.

For Canon (SI2413528ACA) .....359.00 For Nikon (SI2413528ANA) .....359.00  
 For Minolta (SI2413528AMA) .....359.00 For Sigma SA (SI2413528ASA) .....359.00  
 For Pentax (SI2413528APA) .....359.00



#### PERFECT HOODS



Designed for lenses that have a non-rotating front barrel. It has four flanges on its front, two longer at the top and bottom and two shorter ones at the sides with the "corners" between them cut away. They provide more effective shading than conventional hoods because they can be longer or deeper, without cutting off the corners of the image (vignetting).



## AF LENSES FOR CANON, MINOLTA, NIKON, PENTAX & SIGMA

### WIDE ANGLE ZOOM LENSES



#### 28-70mm f2.8-4

This high speed lens features a large aperture, light weight and compact dimensions. At 28mm focal length this lens has a fast f2.8 maximum aperture. Very compact, the lens weighs only 8.6 oz. and measures 2.4" at full-length. The size and weight of this standard lens makes it very suitable for landscape photography, and snapshots. This lens has a minimum focus distance of 19.7" at all focal lengths. It incorporates an aspherical lens element to minimize distortion. The ecological glass used is lead and arsenic free. Filter size: 77mm.

|   |               |   |               |
|---|---------------|---|---------------|
| <b>For Canon</b> (SI287028CCAF) .....   | <b>119.00</b> | <b>For Nikon</b> (SI287028CNAF) .....   | <b>119.00</b> |
| <b>For Minolta</b> (SI287028CMAF) ..... | <b>119.00</b> | <b>For Sigma SA</b> (SI287028CSA) ..... | <b>119.00</b> |
| <b>For Pentax</b> (SI287028CPAF) .....  | <b>119.00</b> |   |               |

#### 28-70mm f2.8 EX DG

The world's smallest, large and constant aperture zoom lens, the 28-70mm f2.8 EX DG features Super Multi Layer (SML) coating to give superb color performance while cutting down flare and ghost. Two SLD elements and four aspherical lenses provide the ultimate correction against distortion as well as all types of aberration, especially spherical aberration. Its advanced optical design ensures high performance throughout the entire zoom range. The use of aspherical lenses also produces a very small and lightweight lens design. Its compact, yet robust, construction has an overall length of 3.4", diameter of 2.9" and a weight of 18 oz. It has a minimum focusing distance of 13" at all focal lengths and a maximum magnification ratio of 1:4.4 which is convenient for close-up photography. The inner focus system allows the lens to be focused without rotating the front element, therefore a Petal-type hood and circular polarizing filters can easily be used. Filter size: 67mm.

|   |               |  |               |
|---|---------------|--|---------------|
| <b>For Canon</b> (SI287028DGCA) .....   | <b>329.00</b> | <b>For Nikon</b> (SI287028DGNA) .....    | <b>329.00</b> |
| <b>For Minolta</b> (SI287028DGMA) ..... | <b>329.00</b> | <b>For Sigma SA</b> (SI287028DGSA) ..... | <b>329.00</b> |
| <b>For Pentax</b> (SI287028DGPA) .....  | <b>329.00</b> |  |               |



#### 28-80mm f3.5-5.6 II Aspherical Mini Zoom Macro

Covering the most popular focal length range from 28mm wide to 80mm mid-range telephoto, this ideal zoom has tele-macro capability for a maximum magnification ratio of 1:2, plus a minimum shooting distance of under 9.5". Everything from grab shots to portraits to close-ups are possible. Sigma's exclusive optical technology makes optimum use of aspherical lens elements to achieve results on par with fixed focal length lenses throughout the entire range. And with an overall length of 2.7" and a weight of under 9 oz., it is perfect for the photographer on the go. Filter size: 55mm.

|   |              |                                       |              |
|---|--------------|---------------------------------------|--------------|
| <b>For Canon</b> (SI288035CAFQ) .....   | <b>79.00</b> | <b>For Nikon</b> (SI288035NAFQ) ..... | <b>79.00</b> |
| <b>For Minolta</b> (SI288035MAFQ) ..... | <b>79.00</b> | <b>For Sigma SA</b> (SI288035P) ..... | <b>79.00</b> |
| <b>For Pentax</b> (SI288035PAFQ) .....  | <b>79.00</b> |                                       |              |



#### 28-105mm f2.8-4.0 Aspherical IF

Featuring a wide focal length range and an unusually large aperture, this lens is perfect for snapshots and great travel photos. The 4-group zoom mechanism fully corrects astigmatism and distortion. Extra-wide aspherical lens allows large f2.8 maximum aperture (at the wide setting) in a compact body. Effective anti-flare feature helps achieve crisp-to-the-edge images. An internal focusing mechanism allows the front of the lens to remain stationary, allowing use of polarizing filters. Includes "Perfect-Hood" lens hood. Filter size: 72mm.

|   |               |   |               |
|---|---------------|---|---------------|
| <b>For Canon</b> (SI2810528CAF) .....   | <b>199.00</b> | <b>For Nikon</b> (SI2810528NAF) .....   | <b>199.00</b> |
| <b>For Minolta</b> (SI2810528MAF) ..... | <b>199.00</b> | <b>For Sigma SA</b> (SI2810528SA) ..... | <b>199.00</b> |
| <b>For Pentax</b> (SI2810528PAF) .....  | <b>199.00</b> |   |               |



# SIGMA

## AF LENSES FOR CANON, MINOLTA, NIKON, PENTAX & SIGMA

CAMERAS & LENSES

166

### WIDE ANGLE ZOOM LENSES

#### 28-105mm f3.8-5.6 UC III Aspherical IF

Building upon its predecessors, this lens offers the same focal length range (28mm to 105mm), and focusing range (19.7 inches to infinity, at all zoom settings) and provides a slightly larger effective aperture (f/3.8-5.6), while reducing the weight to less than 10 oz. A new lens design, including the use of aspherical optics and new mechanical construction, are credited with the reduction in weight, while maintaining the high level of performance for which these lenses are known. Filter size: 62mm.

For Canon (SI2810538CAF) .....129.00      For Nikon (SI2810538NAF) .....129.00  
 For Minolta (SI2810538MAF) .....129.00      For Sigma SA (SI2810538SA) .....129.00  
 For Pentax (SI2810538PAF) .....129.00



#### 28-135mm f/3.8-5.6 Aspherical IF Macro

This lens incorporates aspherical optics, plus a floating inner focusing system, and minimizes spherical aberration and stigmatism. This lens can focus from infinity to 19.7" at all focal lengths and as close as 9.4" (1:2 reproduction ratio) at the 135mm zoom position. It incorporates an inner focusing system and a non-rotating front lens barrel for convenient filter use. Aspherical optics minimize spherical aberration and stigmatism, while the supplied "Perfect-Hood" prevents extraneous light from degrading the image quality. Filter size: 62mm.

For Canon (SI2813538CAF) .....159.00      For Nikon (SI2813538NAF) .....159.00  
 For Minolta (SI2813538MAF) .....159.00      For Sigma SA (SI2813538SA) .....159.00  
 For Pentax (SI2813538PAF) .....159.00



#### 28-200mm f/3.5-5.6 Compact Aspherical Hyperzoom Macro

High performance 28-200mm incorporates one aspherical lens element in the rear lens group and one Special Low Dispersion (SLD) glass element in the front lens group. With a maximum diameter of 2.75" and length of 2.96", it has a compact size. Internal focusing enables it to focus as close as 19.7" from film plane to subject, at all focal lengths, and the use of polarizing filters. Because of the inner focus system, the front barrel does not have to rotate to focus the lens, and a circular polarizing filter can be easily used. It includes the reversible "Perfect-Hood". Filter Size: 62mm.

For Canon (SI2820035MCA) .....199.00      For Nikon (SI2820035MNA) .....199.00  
 For Minolta (SI2820035MMA) .....199.00      For Sigma SA (SI2820035MSA) .....199.00  
 For Pentax (SI2820035MPA) .....199.00



#### 28-300mm f3.5-6.3 Macro

Ultra compact dimensions (3.3" length, 2.9" diameter, and 10.7:1 zoom ratio) make this the ultimate traveling companion. Able to capture a wide ranging series of subjects it incorporates SLD (Special Low Dispersion) glass elements and aspherical lenses, to produce a high level of optical performance. It has a minimum focusing distance of 19.7" at all focal lengths, and is equipped with a macro mechanism for close-up photography at 300mm telephoto, with a reproduction ratio of 1:3. A "zoom lock" prevents the setting from being changed inadvertently, while an internal focusing system eliminates front lens rotation, allowing the use of polarizing filters and Petal type hoods. Filter Size: 62mm

For Canon (SI2830035MCA) .....269.00      For Nikon (SI2830035MNA) .....269.00  
 For Minolta (SI2830035MMA) .....269.00      For Sigma SA (SI2830035MSA) .....269.00  
 For Pentax (SI2830035MPA) .....269.00



**ONE HOUR FREE PARKING**  
 AT 349 W. 34th STREET (with purchase of \$100 or more)

## AF LENSES FOR CANON, MINOLTA, NIKON, PENTAX & SIGMA

### TELEPHOTO ZOOM LENSES

#### 50-500mm f/4-6.3 EX RF APO/HSM

This magnificent 10x superzoom encompasses all focal lengths from "normal" to ultra-telephoto for unmatched versatility. The use of an APO design, SLD glass, a seven group zoom system, and multi-coated optics, enables the highest level of performance. It also employs a rear focus system to insure quick, convenient manual focus and a non-rotating front barrel. The Hyper Sonic Motor provides quiet, responsive autofocus plus "full time" manual focus. Zoom Lock mechanism eliminates "zoom creep" when the lens is tilted up or down. Includes lens hood, magnesium tripod mount and case. Filter size: 86mm (coarse pitch).

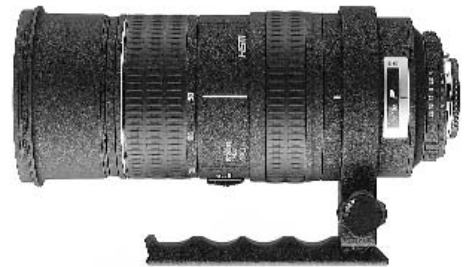

For Canon (SI505004ACAF) .....**999.00** For Nikon (SI505004ANAF) .....**999.00**  
 For Minolta (SI505004AMAF) .....**999.00** For Sigma SA (SI505004A) .....**999.00** For Pentax (SI505004APAF) .....**999.00**

#### 70-200mm f/2.8 EX APO IF/HSM

This lens features apochromatic optical design and four SLD glass elements for high image contrast, resolution and color saturation. Large f/2.8 aperture is constant throughout the zoom range. Hyper Sonic Motor (HSM) provides silent, responsive autofocus action with Canon and Nikon AF cameras, and permits manual focus without having to switch off the autofocus function. Focus Free mechanism keeps the manual focus ring from spinning when the camera is autofocus. Internal zooming mechanism allows the lens length to remain constant during zooming. Includes "Perfect-Hood" lens hood, removable tripod collar and padded soft case. Filter Size: 77mm.



For Canon (SI7020028ACA) .....**839.00** For Nikon (SI7020028ANA) .....**839.00**  
 For Minolta (SI7020028AMA) .....**839.00** For Sigma SA (SI7020028ASA) .....**839.00** For Pentax (SI7020028APA) .....**839.00**

#### 70-300mm f4-5.6 APO Macro Super II

This tele-macro zoom is capable of focusing down to 1:2 (half life-size) ratio at 300mm. An optional 58mm achromatic close-up lens allows even closer focusing and reproduction ratios up to 1:1 (life-size) with superb optical quality. An APO tele zoom lens, the 70-300mm also incorporates two Special Low Dispersion (SLD) glass elements in the front lens group and one in the rear lens group, to minimize chromatic aberration. It includes a reversible bayonet hood and a padded soft case. Filter size: 58mm.



For Canon (SI703004ASCA) .....**219.00** For Nikon (SI703004ASNA) .....**219.00**  
 For Minolta (SI703004ASMA) .....**219.00** For Sigma SA (SI703004ASSA) .....**219.00**  
 For Pentax (SI703004ASPA) .....**219.00**

#### 70-300mm f/4-5.6 Macro Super II

The 70-300mm f4-5.6 DL is a compact tele-macro zoom lens capable of focusing down to 1:2 (half life-size) reproduction ratio at 300mm. An optional 58mm achromatic close-up lens allows even reproduction ratios up to 1:1 (life-size) with superb optical quality. A reversible bayonet hood is provided. Filter Size: 58mm.



For Canon (SI703004SCAF) .....**139.00** For Nikon (SI703004SNAF) .....**139.00**  
 For Minolta (SSI703004SMAF) .....**139.00** For Sigma SA (SI703004SSA) .....**139.00**  
 For Pentax (SSI703004SPAF) .....**139.00**

# SIGMA

## AF LENSES FOR CANON, MINOLTA, NIKON, PENTAX & SIGMA

### TELEPHOTO ZOOM LENSES

#### 80-400mm f/4.5-5.6 EX OS APO

An ultra-telephoto zoom lens with a built-in image stabilizer to eliminate blur caused by camera shake. Two modes compensate for image blurring. Mode 1 determines the camera shake in vertical and horizontal panning and compensates blurring, which is effective when shooting static subjects. Mode 2 detects the vertical camera shake, and overcomes blurring. It is especially effective with moving subjects such as motor sports etc. Two Special Low Dispersion (SLD) glass elements in the front lens group and one in the rear group offer effective control of color aberration. This lens features full-time manual focusing and a removable tripod collar. The rear focus system prevents the front of the lens from rotating; a circular polarizing filter can be easily attached and used. This lens is also equipped with Zoom Lock Switch that eliminates "Zoom Creep".



For Canon (SI8040045CAF) .....999.00      For Nikon (SI8040045NAF) .....999.00      For Sigma SA (SI8040045SA) .....999.00

#### 100-300mm f4.5-6.7 DL



The most compact zoom lens in its class, the 100-300mm f4.5-6.7 DL is less than 4" long and under 2.8" in diameter, with a filter diameter of just 55mm. SLD glass keeps color aberration to a minimum. Ideal for portrait, sports and nature shooting. Includes lens hood. Filter size: 55mm.

For Canon (SI10030045CA) .....129.00      For Nikon (SI10030045NA) .....129.00  
 For Minolta (SI10030045MA) .....129.00      For Sigma SA (SI10030045SA) .....129.00  
 For Pentax (SI10030045PA) .....129.00

#### 100-300mm f4 EX APO IF/HSM

This remarkable telephoto zoom lens provides a large F4.0 maximum aperture at all focal lengths. It uses an APO design and 4 SLD glass elements (two in the front lens group and two in the rear group) for full correction of chromatic aberration — achieving the highest level of optical performance. Canon and Nikon mount are equipped with silent, responsive and high speed HSM (Hyper Sonic Motor) as well as full-time manual focus. A removable tripod mount is also included. This lens incorporates an internal focusing system, allowing the use of a "Perfect Hood" and circular polarizing filters. And since focusing and zooming do not change its overall length, this lens is easy to hold and use. Includes lens hood and case. Filter size: 82mm.



For Canon (SI1003004CAF) .....899.00      For Nikon (SI1003004NAF) .....899.00  
 For Minolta (SI1003004MAF) .....899.00      For Sigma SA (SI1003004SA) .....899.00      For Pentax (SI1003004PAF) .....899.00

#### 120-300mm f2.8 EX APO/HSM



A telephoto zoom lens which retains a constant fast aperture of F2.8 at all focal lengths and allows you to determine the picture composition you want without having to change your vantage point. It has two SLD (Special Low Dispersion) glass elements in the front lens group and one in the rear lens group for excellent correction of chromatic aberration. Models equipped with an HSM (Hyper Sonic Motor) combine high AF speeds with whisper-quiet operation. Since the front lens group does not rotate, it accepts a circular polarizing filter. Use this lens as a 168-420mm f4 AF tele-zoom

lens with the optional APO 1.4x Teleconverter or as a 240-600 mm f5.6 AF ultra-telephoto zoom lens with the APO 2x Teleconverter. The lens materials used in this lens are lead and arsenic free ecological glass. Filter Size: 105mm.

For Canon (SI12030028CA) .....2399.00      For Nikon (SI12030028NA) .....2399.00      For Sigma SA (SI12030028SA) .....2399.00



EQUIPMENT LEASING AVAILABLE



## AF LENSES FOR CANON, MINOLTA, NIKON, PENTAX & SIGMA

### SUPER-TELEPHOTO ZOOM LENSES

#### 135-400mm f/4.5-5.6 Aspherical RF APO

Covering the most frequently used focal lengths, from mid to long-range telephoto, this lens lets you handle an unprecedented range of subjects from landscapes to fast action sports. It incorporates a 5-group zoom system to achieve sharp, high contrast results throughout the entire zoom range. Three SLD glass elements eliminate the secondary spectra effect normally associated with telephotos, while the rear focus system keeps the front lens from rotating, giving you easier use of polarizing filters. A convenient built-in rotary tripod mount eliminates vibration during shutter release. Includes reversible lens hood and padded soft lens case. Filter size: 77mm.



|                                  |        |                                   |        |
|----------------------------------|--------|-----------------------------------|--------|
| For Canon (SI13540045CA) .....   | 559.00 | For Nikon (SI13540045NA) .....    | 559.00 |
| For Minolta (SI13540045MA) ..... | 559.00 | For Sigma SA (SI13540045SA) ..... | 559.00 |
| For Pentax (SI13540045PA) .....  | 559.00 |                                   |        |

#### 170-500mm f5-6.3 Aspherical RF APO

This convenient and practical lens is great for sports and nature. It combines a 5 lens group zoom system with an aspherical lens element to deliver sharp high contrast images throughout the entire zoom range. It uses Sigma's unique apochromatic lens design and three SLD glass elements to eliminate aberrations usually found in ultra-telephoto lenses. And with Sigma's new focusing system, the front lens group doesn't rotate, which makes using polarized filters a snap. A convenient built-in rotary tripod mount eliminates vibration during shutter release. Includes a reversible lens hood and padded soft lens case. Filter Size: 86mm coarse pitch.



|                                  |        |                                   |        |
|----------------------------------|--------|-----------------------------------|--------|
| For Canon (SI1705005ACA) .....   | 699.00 | For Nikon (SI1705005ANA) .....    | 699.00 |
| For Minolta (SI1705005AMA) ..... | 699.00 | For Sigma SA (SI1705005ASA) ..... | 699.00 |
| For Pentax (SI1705005APA) .....  | 699.00 |                                   |        |

#### 300-800mm f5.6 EX IF APO/HSM

The 300-800mm f/5.6 EX IF APO/HSM is currently the longest zoom lens made by any manufacturer, and is ideal for nature/outdoor or sports photography. This extreme telephoto zoom lens provides a relatively large constant f/5.6 maximum aperture at all focal lengths. It covers the ultra-telephoto range up to 800mm. By continuously varying the angle of view from 8.2° to 3.1°, the lens takes a lot of the footwork out of picture composition. The use of Apochromatic design and two ELD (Extraordinary Low Dispersion) glass elements in the front lens group give full correction of chromatic aberration and provide a high level of optical performance. The AF drive for the Canon EOS, Nikon and Sigma mounts are equipped with the silent, responsive and high speed Hyper Sonic Motor and provides full-time manual focus override. A tripod mount is provided with the lens. Since zooming does not change the lens overall length, the lens is easy to hold and use. The materials used are lead and arsenic free ecological glass. Filter size: 46mm, in rear.



|                                |         |                                |         |                                   |         |
|--------------------------------|---------|--------------------------------|---------|-----------------------------------|---------|
| For Canon (SI3008005ACA) ..... | 6199.00 | For Nikon (SI30080056NA) ..... | 6199.00 | For Sigma SA (SI3008005ASA) ..... | 6199.00 |
|--------------------------------|---------|--------------------------------|---------|-----------------------------------|---------|

# SIGMA

## LENS SPECIFICATIONS

| Lens                    | Corresponding AF Mount |   |   |   |   | Angle of View View (Diag.) | Minimum Aperture | Minimum Focus Distance | Filter Size   | Dimensions   | Weight    |
|-------------------------|------------------------|---|---|---|---|----------------------------|------------------|------------------------|---------------|--------------|-----------|
|                         | S                      | M | N | P | C |                            |                  |                        |               |              |           |
| 8mm f/4                 | O                      | O | D | O | O | 180°                       | 32               | 7.9"                   | Rear Filter   | 2.9 x 2.4"   | 11.2 oz.  |
| 14mm f/2.8              | O                      | O | D | O | O | 114.2°                     | 22               | 7.1"                   | Rear Filter   | 3.2 x 3.6"   | 23.3 oz.  |
| 15mm f/2.8              | O                      | O | D | O | O | 180°                       | 22               | 5.9"                   | Rear Filter   | 2.9 x 2.8"   | 11.7 oz.  |
| 20mm f/1.8              | O                      | D | D | O | O | 94.5°                      | 22               | 7.9"                   | 82mm          | 3.5 x 3.4"   | 18.3 oz.  |
| 24mm f/1.8              | O                      | D | D | O | O | 84.1°                      | 22               | 7.1"                   | 77mm          | 3.3 x 3.1"   | 17.1 oz.  |
| 28mm f/1.8              | O                      | O | D | O | O | 75.4°                      | 22               | 7.9"                   | 77mm          | 3.3 x 3.1"   | 16.9 oz.  |
| 50mm f/2.8              | O                      | O | D | O | O | 46.8°                      | 32/45            | 1.6"                   | 55mm          | 2.8 x 2.5"   | 11.3 oz.  |
| 105mm f/2.8             | O                      | O | D | O | O | 23.3°                      | 32/45            | 4.7"                   | 58mm          | 3.1 x 3.7"   | 15.9 oz.  |
| 150mm f/2.8             | O                      | O | D | O | O | 16.4°                      | 22               | 15"                    | 72mm          | 3.1 x 5.4"   | 31.6 oz.  |
| 180mm f/3.5             | O                      | O | D | O | O | 13.7°                      | 32               | 9.05"                  | 72mm          | 3.1 x 7.1"   | 33.3 oz.  |
| 300mm f/2.8             | O                      | O | D | O | O | 8.2°                       | 32               | 98.4"                  | 46mm (rear)   | 4.7 x 8.4"   | 84.7 oz.  |
| 500mm f/4.5 APO         | O                      | O | D | O | O | 5°                         | 32               | 157.5"                 | 46mm (rear)   | 4.8 x 13.8"  | 109.7 oz. |
| 600mm f/8               | O                      | O | O | O | O | 4.1°                       | 8 (fixed)        | 78.7"                  | 30.5mm (rear) | 3.9 x 4.8"   | 29.3 oz.  |
| 12-24mm f/4.5-5.6       | O                      | D | D | O | O | 122°-84.1°                 | 22               | 11"                    | Rear filter   | 3.4 x 3.9"   | 21.6 oz.  |
| 15-30mm f/3.5-4.5       | O                      | D | D | O | O | 110°-71.6°                 | 22               | 11.8"                  | Rear Filter   | 3.4 x 5.1"   | 21.8 oz.  |
| 17-35mm f/2.8-4         | O                      | D | D | O | O | 103.7°-63.4                | 22               | 10.6"                  | 77mm          | 3.3 x 3.4"   | 19.8 oz.  |
| 20-40mm f/2.8           | O                      | D | D | O | O | 94.5°-56.8°                | 22               | 11.8"                  | 82mm          | 3.5 x 4.2"   | 20.9 oz.  |
| 24-60mm f/2.8           | O                      | D | D | O | O | 84.1° - 39.6°              | 22               | 14.9"                  | 77mm          | 3.3 x 3.4"   | 19.4 oz.  |
| 24-70mm f/2.8           | O                      | D | D | O | O | 84.1° - 34.3°              | 32               | 15.7"                  | 82mm          | 3.5 x 4.5"   | 25.2 oz.  |
| 24-70mm f/3.5-5.6       | O                      | D | D | O | O | 84.1° - 34.3°              | 22               | 15.7"                  | 62mm          | 2.7 x 3"     | 10.1 oz.  |
| 24-135mm f/2.8-4.5      | O                      | D | D | O | O | 84.1°-18.2°                | 32               | 19.7"                  | 77mm          | 3.3 x 3.6"   | 18.8 oz.  |
| 28-70mm f/2.8-4         | O                      | D | D | O | O | 75.5°-34.3°                | 22               | 19.7"                  | 58mm          | 2.7 x 2.4"   | 8.6 oz.   |
| 28-70mm f/2.8 EX DG     | O                      | O | D | O | O | 75.4°-34.3°                | 32               | 15.7"                  | 77mm          | 3.3 x 4.0"   | 22.7 oz.  |
| 28-80mm f/3.5-5.6 II    | O                      | O | D | O | O | 75.4° - 30.3°              | 22               | 23.9" (9.8" Macro)     | 55mm          | 2.7 x 2.8"   | 9 oz.     |
| 28-105mm f/2.8-4        | O                      | O | D | O | O | 75.4°-23.3°                | 22-32            | 19.7"                  | 72mm          | 3.0 x 3.1"   | 14.3 oz.  |
| 28-105mm f/3.8-5.6      | O                      | O | D | O | O | 75.4°-23.3°                | 22               | 19.7"                  | 62mm          | 2.8 x 2.9"   | 9.7 oz.   |
| 28-135mm f/3.8-5.6      | O                      | O | D | O | O | 75.4° - 18.2°              | 22               | 19.7" (9.4" Macro)     | 62mm          | 2.9 x 2.9"   | 14.5 oz.  |
| 28-200mm f/3.5-5.6      | O                      | D | D | O | O | 75.4° - 12.3°              | 22               | 18.9"                  | 62mm          | 2.76 x 2.96" | 13.4 oz.  |
| 28-300mm f/3.5-6.3      | O                      | D | D | O | O | 75.4° - 8.2°               | 22               | 19.7"                  | 62mm          | 2.9 x 3.3"   | 16.2 oz.  |
| 50-500mm f/4-6.3        | O                      | O | D | O | O | 46.8°-5°                   | 22               | 39.4-118.1"            | 86mm          | 3.7 x 8.5    | 64.9 oz.  |
| 70-200mm f/2.8          | O                      | O | D | O | O | 34.3°-12.3°                | 32               | 70.9"                  | 77mm          | 3.4 x 7.2"   | 44.8 oz.  |
| 70-300mm f/4-5.6 APO II | O                      | O | D | O | O | 34.3°-8.2°                 | 22               | 95" (37.4 Macro)       | 58mm          | 3.0 x 4.7"   | 18.7 oz.  |
| 70-300mm f/4-5.6 II     | O                      | O | D | O | O | 34.3°-8.2°                 | 22               | 59" (37.4" Macro)      | 58mm          | 3.0 x 4.8"   | 19.2 oz.  |
| 80-400mm f/4.5-5.6      | O                      | - | D | - | O | 30.3° - 6.2°               | 32               | 70.9"                  | 77mm          | 3.74 x 7.6"  | 61.8 oz.  |
| 100-300mm f/4.5-6.7 DL  | O                      | O | D | O | O | 24.4°-8.2°                 | 22-32            | 78.8"                  | 55mm          | 2.8 x 3.9"   | 14.5 oz.  |
| 100-300mm f/4           | O                      | D | D | O | O | 24.4° - 8.2°               | 32               | 70.9"                  | 82mm          | 3.6 x 8.9"   | 50.8 oz.  |
| 120-300mm f/2.8         | O                      | - | D | - | O | 20.4° - 8.2°               | 32               | 59-98.4"               | 105mm         | 4.4 x 10.74" | 91.7 oz.  |
| 135-400mm f/4.5-5.6     | O                      | O | D | O | O | 18.2° - 6.2°               | 32               | 78.8 - 86.6"           | 77mm          | 3.5 x 0.72"  | 43.9 oz.  |
| 170-500mm f/5-6.3       | O                      | O | D | O | O | 14.5° - 5°                 | 32               | 118.1 - 126"           | 86mm          | 3.6 x 9.1"   | 47.4 oz.  |
| 300-800mm f/5.6         | O                      | - | D | - | O | 8.2° - 3.1°                | 32               | 236.2"                 | 46mm (rear)   | 6.5 x 21.4"  | 207.4 oz. |



For Any Inquiries Regarding Your Order, Call Our Customer Service:  
 (800) 221-5743 • (212) 239-7765 • FAX: (800) 947-2215 • (212) 239-7549

# ROLLEI

## 35RF



### Manual Rangefinder Camera

The 35 RF is a manual rangefinder camera reminiscent of old times. Its die-cast aluminum chassis, silver finish, rubber side grip and high quality bayonet-mount lenses all make this the perfect choice for the serious rangefinder user. A classic rangefinder camera with high-end features, the 35RF offers mechanical and optical perfection, as well as brilliant viewfinder image, compact design, precise distance measurement and modern high-performance lenses.

- ◆ Its range-viewfinder is an optical tool of the utmost precision and guarantees a precise manual focusing.
- ◆ Framelines for 40, 50, 80mm lenses
- ◆ Precise trigonometric focusing in a permanently brilliant viewfinder ensures pin-point focus even in critical lighting conditions.
- ◆ Camera body is made of die-cast aluminum, and metal cover plates are in silver finish, with black rubberized finger grips
- ◆ Rollei M bayonet mount (accepts Leica and other brand M-mount lenses, as well as Canon, Contax, Leica, Nikon and Voigtlander 39mm screwmount lenses with an adapter)
- ◆ The laminar metal focal-plane shutter makes shutter release an aesthetic pleasure. A very exact sounding shutter release tells you that your picture has been recorded on film.
- ◆ Manually set ISO from 25-3200
- ◆ Shutter speeds range from a slow 1 second to a fast 1/2000 of a second to cover the most demanding shooting situations.
- ◆ Offers flash sync at 1/125 second via PC terminal and hot-shoe contact
- ◆ For exposure metering, the 35RF offers center-weighted TTL average metering (activated by lightly pressing the shutter release). Has a correct-exposure display and warnings against over/under exposure
- ◆ Manual loading, winding and rewinding
- ◆ Complete functional range even if batteries are low (except for exposure metering)

#### 35RF 35mm Rangefinder Manual Focus Camera Body (RO35RF)

With strap, two 1.5-volt batteries and 2-year warranty .....599.95

#### 35RF 35mm Rangefinder Manual Focus Camera Kit (RO35RF40K)

With Sonnar 40mm f/2.8 HFT lens, strap, two 1.5-volt batteries and 2-year warranty ...1019.95

## 35RF ACCESSORIES

### 40mm f/2.8 Sonnar HFT Manual Focus Lens

The 40mm f/2.8 Sonnar HFT is a high-quality general purpose lens for the 35RF, ideal for indoor and outdoor use. Compact and lightweight, its initial aperture of f/2.8 gives it a wide margin for shooting in low light with excellent focusing results. Available in black or chrome. Filter size is 39mm.



40mm f/2.8 Sonnar HFT (RO4028RF35S):  
Chrome .....549.95

40mm f/2.8 Sonnar HFT (RO4028RF35B):  
Black .....679.95

### 80mm f/2.8 Planar HFT Manual Focus Lens

The 80mm f/2.8 Planar HFT lens for the 35RF rangefinder camera is a medium focal length lens ideal for portraiture, landscape details and candid shots from a certain distance. This lens design is based on the legendary medium-format lens used in the famous twin-lens Rolleiflex 2.8 Series, known for its superior field flattening. Available in black or chrome. Filter size is 43mm.

80mm f/2.8 Planar HFT (RO8028RF35S): Chrome.....1349.95  
80mm f/2.8 Planar HFT (RO8028RF35B): Black .....1449.95



### Rapid Trigger Winder

A valuable accessory for the 35RF, this winder can be skillfully operated for a film advance rate of up to 3 fps (frames per second). You can leave the winder on the camera and still change the film (RORTW35) .....400.00



# TAMRON

## MANUAL FOCUS LENSES

### Adaptall-2 Interchangeable Mount System

Tamron stands apart from other lens manufacturers with its use of an interchangeable mount system instead of a fixed-mount. Fixed-mount lenses are limited to use on cameras using that specific mount system. Tamron's interchangeable Adaptall mounts mean you can use the lens on virtually any manual-focus SLR camera. In fact, Tamron offers approximately 20 different mounts useable with some 200 35mm SLRs.



#### Adaptall-2 Mounts are available for:

- Canon FD/FT Series
- Contax/Yashica Series
- Fujica ST Series
- Fujica AX Bayonet Series
- Konica AR Series
- Leica R4 Series
- Mamiya ZE Series
- Minolta MD/SR Series
- Nikon AI Series
- Olympus OM Series
- Pentax ES/Spotmatic Series
- Pentax K Series
- Pentax Super-A Series
- Praktica B200 Series
- Ricoh XR-P Series
- Rollei SL-35/Voigtlander VSL Series
- Universal (42mm Screw)
- Dynax/Maxxum Series
- C-mount for CCTV/VCR

#### 24mm f/2.5 (TA2425)

This lens provides a field of view of 84° for full image framing applications. It also has an F number of f/2.5 which is approximately 25% faster than comparable f/2.8 lenses. Yet this lens is very compact with an overall length of 1.7" and diameter of 2.7" and weighs just 8oz. Filter size: 55mm.....**249.95**

#### SP 90mm f/2.8 1:1 Macro (TA9028M)

The portrait capabilities of this popular lens is further enhanced with its fast f2.8 aperture. For handling ease, the lens weighs a mere 14oz., making it ideal for taking advantage of its maximum macro magnification ratio of 1:1. Its f2.8 aperture and 9-bladed diaphragm help in producing soft out-of-focus backgrounds, while the optical design of the lens ensures sharp images from corner-to-corner. Includes hood and soft pouch. Filter size: 55mm .....**489.00**

#### SP 300mm f/2.8 LD (IF) (TA30028)

An ultra-high performance, fast telephoto lens that is well suited to both the fast-action world of sports photography and to shooting indoor theatrical events. The nine-blade aperture design makes a nearly circular opening for a soft blurred background-an ideal effect for portraiture. Two large LD elements incorporated in the optical design produce sharp, clear pictures with high contrast and true color fidelity from corner-to-corner. Includes a lens hood, soft case and 43mm drop-in filter holder with filter. Filter size: 112mm front; 43mm rear drop-in .....**2649.95**

#### SP 500mm f/8 Reflex (TA5008)

This is a catadioptric-type ("reflex") telephoto lens with two silver evaporation coated reflective mirrors. The silver evaporation coating on the rear lens surface compensates for spherical aberrations on reflective surface giving high quality images throughout the focusing range. Tele-macro is also available with a short minimum focusing distance of 67" and a maximum magnification ratio of 1:3. It includes a hood, hard case, and a 30.5mm drop-in filter holder with a UV Filter. Filter size: 82mm front; 30.5mm rear drop-in .....**459.95**



24mm f/2.5

SP 90mm f/2.8 1:1 Macro

SP 300mm f/2.8 LD (IF)

SP 500mm f/8 Reflex



**ONE HOUR FREE PARKING**  
**AT 349 W. 34th STREET** (with purchase of \$100 or more)

# TAMRON

## MANUAL FOCUS LENSES

### **28-70mm f/3.5-4.5** (TA287035)

Extremely lightweight and compact, this zoom lens feels more like a standard fixed focal length lens yet delivers coverage from a real wide angle 28mm to a medium telephoto 70mm. In addition, the 28-70mm has a tele-macro function with a maximum magnification ratio of 1:3 at 70mm for good close-ups. The 28-70mm is made to travel since this focal length range can handle everything from group shots to scenic landscape pictures. Filter size: 52mm.....**189.95**

### **SP 28-105mm f/2.8 LD Aspherical (IF)** (TA2810528)

This lens establishes a new benchmark as a standard lens, extending from a wide 28mm all the way to 105mm telephoto, with a fast constant 2.8 maximum aperture. The use of four large diameter aspherical elements and three LD glass elements reduces various aberrations while minimizing the fall-off of light at the corners. Tamron's Internal Focusing system and Triple-Cam zoom system combine to permit a body that at the 28mm zoom position is very compact, with excellent optical performance. Also, an Anti-Slip-Mode mechanism prevents the lens barrel from sliding outward under its own weight. Includes a lens hood and soft case. Filter size: 82mm .....**949.00**

### **28-200mm f/3.8-5.6 LD Aspherical (IF) Super** (TA2820038A)

The 28-200mm is loaded with state-of-the-art features, and can be used with more than 200 different 35mm SLR cameras, old and new. Furthermore, zoom and focus ring patterns are changed to improve overall handling ease. Includes a lens hood. Filter size: 72mm.....**299.95**

### **60-300mm f/3.8-5.4** (TA6030038)

This powerful telephoto zoom lens goes from a medium telephoto of 60mm to an ultra-telephoto range of 300mm quickly and easily. The lens includes a macro function with a maximum magnification ratio of 1:1.5. A one-touch ring feature means focusing, zooming, and macro modes are accessible using just one control ring. Includes a lens hood and case. Filter size: 62mm .....**439.00**

### **SP 70-210mm f/3.5** (TA7021035)

Another zoom from the high quality SP series, this lens features a constant F/3.5 maximum aperture and 3x zoom ratio. Tele-macro is also available with a maximum magnification ratio of 1:2.6. The true color reproduction quality combined with the macro feature make this lens an excellent choice for flower photography or any detailed nature study. Includes a lens hood and a soft case. Filter size: 62mm .....**399.95**

### **70-210mm F/4-5.6** (TA702104)

A very compact zoom measuring just 79mm (3.1") yet zoom up to a focal length of 210mm. The lens which is highly portable and easy to use is constructed of 13 elements in 9 groups. It produces corner-to-corner sharp pictures with good contrast. A macro function is incorporated with a maximum magnification ratio 1:4. Includes hood. Filter size: 52mm .....**194.95**

### **2x Tele-Converter**

This tele-converter doubles both the aperture and magnification ratio of lens, and retains the original lens minimum focus. It has a 2.6" diameter, and weighs 4.2 oz. Available for Nikon AI (TA2X4N), Olympus OM (TA2X4O), Minolta MD (TA2X4M) and Pentax/Ricoh (TA2X4P).....**68.50**



28-70mm f/3.5-4.5

SP 28-105mm f/2.8 LD Aspherical (IF)

28-200mm f/3.8-5.6 LD Aspherical (IF) Super

70-210mm f/4-5.6

SP 70-210mm f/3.5

2x Tele-Converter

CAMERAS & LENSES

173

ORDER & INFO. (212) 502-6340 • FAX: (212) 239-7770 (800) 947-7008  
**1-800-290-6750 • www.bhphotovideo.com**



# TAMRON

## AUTOFOCUS LENSES

CAMERAS & LENSES

174

### WIDE-ANGLE, TELEPHOTO & MACRO LENSES

#### **SP AF14mm f/2.8 Aspherical [IF]**

This ultra wide angle lens features a fast F/2.8 aperture and a sophisticated optical system allowing photographers to create dynamic photographs that take full advantage of the rectangular characteristics of the lens. Two Hybrid Aspherical lens elements eliminate distortion and comatic flare associated with ultra wide angle lenses. The result is a fast focusing lens that delivers high quality images with minimal light fall off at the picture corners. The lens is also equipped with a one-touch focusing mechanism that allows the focus mode to be switched with a simple push/pull movement. The lens has a large focusing ring, built-in lens hood and gelatin filter holder at the rear element of the lens. Includes built-in lens hood and a padded case.



For Canon (TA1428ACAF) .....999.95    For Nikon (TA1428ANAF) .....999.95  
 For Minolta (TA1428AMAF) .....999.95    For Pentax (TA1428APAF) .....999.95



#### **SP AF90mm f/2.8 Di 1:1 Macro**

This compact and lightweight lens boasts high resolving power and sharp image depiction with ideal background blur, making it ideal for close-up and portrait photography. A wide, smooth focusing ring makes delicate manual focusing in the macro mode easy and precise. An optical multi-coating is applied to its element surfaces to meet digital SLR performance characteristics. Includes a hoos and soft pouch. Filter size: 55mm.

For Canon (TA9028MCAF) .....479.95    For Nikon (TA9028MNAF) .....479.95  
 For Minolta (TA9028MMAF) .....479.95    For Pentax (TA9028MPAF) .....479.95

#### **AF 180mm f/3.5 Di LD [IF] 1:1 Macro**

This lens employs an internal focusing system that maintains the overall length of the lens during focusing. Two Low Dispersion glass elements effectively compensate for chromatic aberration. It provides high-contrast, outstanding image quality and a soft out-of-focus background effect. An AF/MF one touch switch over mechanism is built into the focus ring (for Canon and Nikon only). An FEC (Filter Effect Control) function enhances the operational ease of polarizing filter use by rotating the filter to the desired position while the hood is attached. The lens comes complete with a tripod mount, a hood and a neoprene custom case with a carrying strap. Filter size: 72mm.



For Canon (TA18035CAF) .....679.95    For Nikon (TA18035NAF) .....679.95  
 For Minolta (TA18035MAF) .....679.95    For Pentax (TA18035PAF) .....679.95

#### **SP AF300mm f/2.8 LD [IF]**



This fast telephoto delivers the exacting performance demanded by professionals. Two large LD (Low Dispersion) elements provide high contrast and crystal-clear image quality from the full open aperture. Internal Focusing (IF) lets you maintain optimum holding balance since the lens' overall length remains constant during focusing. Tamron's Floating Focusing System improves optical performance especially at close shooting distances. Nine bladed iris forms a nearly perfect circle to create excellent background blur for outdoor portraits. The ideal lens for shooting nature, sports and low light indoor performances. Conveniences include easy-to-use AF/MF focusing ring, supplied rear filter insertion frame and circular polarizer, detachable tripod mount, and a lens hood. It also includes a soft case. Filter size: 43mm rear drop-in, 112mm front.

For Canon (TA30028CAF) .....2999.00    For Nikon (TA30028NAF) .....2799.00    For Minolta (TA30028MAF) .....2799.00

Select Tamron lenses include rebates up to \$300. Please go on-line or call for details and expiration dates.



EQUIPMENT LEASING AVAILABLE

# TAMRON

## AUTOFOCUS LENSES

### WIDE ANGLE ZOOM LENSES

CAMERAS & LENSES

175



#### **SP AF17-35mm F/2.8-4 Di LD Aspherical [IF]**

A super wide-angle zoom lens that provides extended focal length covering and an entirely new optical system for optimal performance with digital SLR cameras. When used with CCD or CMOS image sensors the 17mm-focal length can achieve a 35mm SLR equivalent of approximately 24mm, allowing photographers to fully utilize its vast perspective and depth of field.

Ghost flare, common in backlit situations, is vastly reduced, enabling clear, high-definition photography. Image distortion, aspherical aberrations and other aberrations are corrected and eliminated through the use of a compound aspherical element. Moreover, color aberrations characteristic of wide-angle lenses have been diminished through the use of an LD element. Includes a lens hood. Filter Size is 77mm.

**For Canon (TA173528CAF) .....469.95      For Nikon (TA173528NAF) .....469.95**  
**For Minolta (TA173528MAF) .....469.95      For Pentax (TA173528PAF) .....469.95**

#### **AF19-35mm f/3.5-4.5**

An affordable super wide-angle zoom ideal for travel, landscape, group portrait, adventure photography and more. Offering an authentic super wide-angle range with an angle of view of 97°- 63° and a close M.O.D. of 19.68", this 19-35mm provides dramatic and fun image making. The lens is easy to carry anywhere as it weighs just 10.5 ounces and is only 2.66" long. It also features a fixed front element group and filter mount, facilitating the use of polarizing filters. It includes a hood. Filter size is 77mm.

**For Canon (TA193535CAF) .....219.95      For Nikon (TA193535NAF) .....219.95**  
**For Minolta (TA193535MAF) .....219.95**



#### **SP AF24-135mm f/3.5-5.6 AD Aspherical [IF]**

Versatile and flexible, this high power zoom lens takes you from 24mm wide angle to 135mm telephoto. It incorporates an AD (Anomalous Dispersion) glass element with four hybrid aspherical elements to achieve sharp, crisp resolution and brilliant, vivid color reproduction. Internal Focusing (IF) makes the lens more compact and allows the use of a polarizing filter. The lens also features a high 1:3.3 macro magnification ratio at 135mm, making it possible to fill the frame with a subject no larger than a postcard. It includes a lens hood and a case. Filter size: 72mm.

**For Canon (TA2413535CAF) .....369.95      For Nikon (TA2413535NAF) .....369.95**  
**For Minolta (TA2413535MAF) .....369.95      For Pentax (TA2413535PAF) .....369.95**

#### **SP AF28-75mm f/2.8 XR Di LD Aspherical [IF] Macro**

The world's lightest and most compact fast standard zoom lens, the SP AF28-75mm Macro utilizes XR size reduction technology to achieve the lens' compact size—maximum diameter of 2.9", 3.6" long and only 17.9 oz. In addition, with the Digitally Integrated Design, it provides optimum performance when used with the latest digital SLR cameras. The use of Extra Refractive Index glass enables reduction in size while at the same time compensating for aberrations. Three LD (Low Dispersion) elements ensure superb image quality. It incorporates a convenient zoom lock mechanism that keeps the lens retracted when being carried on a camera, helping to prevent the lens from accidentally being knocked or bumped when walking through crowds. Supplied flower-shaped hood with excellent stray-light shielding properties. 67mm filter size.

**For Canon (TA287528CAF) .....369.95      For Nikon (TA287528NAF) .....369.95**  
**For Minolta (TA287528MAF) .....369.95      For Pentax (TA287528PAF) .....369.95**



**ORDER & INFO. (212) 502-6340 • FAX: (212) 239-7770 (800) 947-7008**  
**1-800-290-6750 • www.bhphotovideo.com**



# TAMRON

## AUTOFOCUS LENSES

CAMERAS & LENSES

176

### HIGH PERFORMANCE ZOOM LENSES

#### **SP AF28-105mm f/2.8 LD Aspherical [IF]**

This lens features a fast f/2.8 aperture even at 105mm, so you can shoot fantastic portraits with better background blur. The use of four large diameter aspherical elements and three LD (Low Dispersion) glass elements reduces various aberrations while minimizing the fall-off of light at the corners. IF (Internal Focusing) and Triple-Cam zoom system contribute to the lens' extreme compactness and excellent optical performance. Since the front lens group doesn't rotate, you can use polarizing filters or the supplied lens hood. An Anti-Slip-Mode mechanism prevents the lens barrel from slipping downward. Includes a lens hood and soft case. Filter size: 82mm.

For Canon (TA2810528CAF) .....769.95    For Nikon (TA2810528NAF) .....769.95    For Minolta (TA2810528MAF) ..769.95



#### **AF28-200mm f/3.8-5.6 XR Aspherical [IF] Macro**

Incorporating revolutionary optics, the AF 28-200mm achieves superior image quality and compactness in the same zoom lens. XR Glass bends light more than normal or lower refractive index glasses, which makes the length of the whole optical system shorter. In addition, optical power is enhanced with three aspherical lenses, each which do the job of several lenses combined, to reduce and eliminate aberration in the shortened optical configuration. Key to the perfection of the lens was development of the 'moving triple cam' – the mechanism that helps the lens achieve rock-solid stability during the radical barrel movement between the retracted 28mm position to the extended 200mm position. This remarkable mechanism transforms the conventional fixed triple cam into a moving unit that slides in conjunction with zooming action. Includes a lens hood. Filter size: 62mm.

For Canon (TA2820038CAF) .....269.95    For Nikon (TA2820038NAF) .....269.95  
 For Minolta (TA2820038MAF) .....269.95    For Pentax (TA2820038PAF) .....269.95

#### **AF28-300mm f/3.5-6.3 XR Di LD Aspherical [IF] Macro**

A quantum leap in design, technology and manufacturing, the AF28-300mm is built with an optical system that incorporates three Hybrid Aspherical elements and two high-grade LD (Low Dispersion) glass elements. Together they provide never-before-possible sharpness, contrast and color depth, while eliminating chromatic aberrations inherent to a high-power zoom lens of this magnitude. These state-of-the-art optics are housed in a sophisticated "Quad-Cam Zoom Mechanism" which enables four lens barrels to be extended and retracted effortlessly - achieving compactness at 28mm, while holding precise extension at 300mm. It features an Internal Focusing (IF) system, minimizing illumination loss at image corners, and suppressing aberrations that are caused by focusing positions. Includes a lens hood. Filter size: 62mm.

For Canon (TA2830035XDC) .....399.00    For Nikon (TA2830035XDN) .....399.00  
 For Minolta (TA2830035XDM) .....399.00    For Pentax (TA2830035XDP) .....399.00



#### **AF70-300mm f/4.0-5.6 LD Macro**

This is the definitive lightweight, compact telephoto macro zoom with a maximum magnification ratio of 1:2 at the 300mm setting — ideal for shooting subjects that are difficult to approach such as sporting and theatrical events. The lens also has the ability to provide beautifully blurred backgrounds and to highlight the main subject in protraiture, or "compression effects" that make the most of the telephoto lens. Switch to macro mode, and subjects as close as 37" can be shot within the focal range of 180-300mm, for true macro photography. It includes a lens hood. 62mm filter size.

For Canon (TA703004MCAF) .....149.95    For Nikon (TA703004MNAF) .....149.95  
 For Minolta (TA703004MMAF) .....149.95    For Pentax (TA703004MPAF) .....149.95



EQUIPMENT LEASING AVAILABLE



# TAMRON

## AUTOFOCUS LENSES

### HIGH PERFORMANCE ZOOM LENSES

#### *SP AF200-500mm f/5-6.3 Di LD [IF*

Bring your far away subjects up close while compressing the distance between the main subject and the background for professional-looking results. Even though this lens covers a range up to 500mm, its design is relatively lightweight and compact. The optical design of this lens enables you to get as close as 8.2' from your main subject at any focal length, and provides a maximum magnification ratio of 1:5 at the 500mm end, allowing for dynamic and impressive pictures of small objects.

This lens sports the detachable Filter Effect Control ring which allows a filter to be rotated to the desired position with the hood still attached. This enables you to simultaneously perform minute adjustments to a polarizer filter. You can confirm the Polarizing effect through the viewfinder, all while using the hood to prevent harmful light from entering the lens. The Di designation means that this lens features an optical system that is designed to meet the performance characteristics of digital SLR cameras. This lens includes a lens hood, detachable filter effect control and a soft lens case with a strap. Filter size: 86mm.



For Canon (TA20050056C) .....**879.00** For Nikon (TA20050056N).....**879.00** For Minolta (TA20050056M) ..**879.00**

CAMERAS & LENSES

177



| AF TeleConverters                          | 1.4X                                   | 2X                                   | 1.4X SP                          | 2X SP                            |
|--|--|--------------------------------------|----------------------------------|----------------------------------|
| <b>Lens Construction (Groups/Elements)</b> | 4 groups<br>4 elements                 | 4 groups<br>4 elements               | 4 groups<br>5 elements           | 4 groups<br>7 elements           |
| <b>Maximum Magnification</b>               | 1.4X the mag<br>ratio of original lens | 2X the mag<br>ratio of original lens | Approx. 2 times<br>= 1 diaphragm | Approx. 4 times<br>= 2 diaphragm |
| <b>Length</b>                              | 0.7"                                   | 1"                                   | 19.4mm                           | 43.5mm                           |
| <b>Available Mounts</b>                    | Canon, Minolta,<br>Nikon, Pentax       | Canon, Minolta,<br>Nikon, Pentax     | Canon, Minolta,<br>Nikon         | Canon, Minolta,<br>Nikon         |
| <b>Price</b>                               | <b>79.95</b>                           | <b>144.95</b>                        | <b>174.95</b>                    | <b>194.95</b>                    |

| AF Lenses                             | Groups/<br>Elements | Angle<br>of View | Minimum Focusing<br>Distance | Filter<br>Size | Dimensions   | Weight   |
|---------------------------------------|---------------------|------------------|------------------------------|----------------|--------------|----------|
| SP AF14mm f/2.8 IF                    | 12/14               | 114°             | 7.9"                         | —              | 3.4 x 3.4"   | 23.8 oz. |
| SP AF90mm f/2.8 Di Macro              | 9/10                | 27°              | 11.4"                        | 55mm           | 2.8 x 3.8"   | 14.3 oz. |
| AF 180mm f/3.5 Di 1:1 Macro           | 11/14               | 14°              | 18.5"                        | 72mm           | 3.3 x 6.5"   | 32.5 oz. |
| SP AF300mm f/2.8 LD IF                | 7/10                | 8°               | 98.4"                        | 43mm           | 4.7 x 8.4"   | 80 oz.   |
| SP AF17-35mm f/2.8-4 Di LD Aspherical | 11/14               | 104° - 63°       | 11.8"                        | 77mm           | 3.41 x 3.28" | 15.5 oz. |
| AF19-35mm f/3.5-4.5                   | 13/11               | 97° - 63°        | 1.6'                         | 77mm           | 2.7 x 3.2"   | 9.6 oz.  |
| SP AF24-135mm f/3.5-5.6 IF            | 10/14               | 84° - 18°        | 15.7"                        | 72mm           | 3.1 x 3.2"   | 18.7 oz. |
| SP AF28-75mm f/2.8 XR Di LD Macro     | 14/16               | 75° - 32°        | 13"                          | 67mm           | 2.9 x 3.6"   | 18 oz.   |
| SP AF28-105mm f/2.8 LD IF             | 13/15               | 75° - 24°        | 19.3"                        | 82mm           | 3.4 x 4.4"   | 1.93 lb. |
| SP AF28-200mm f/3.8-5.6 XR IF         | 10/14               | 75° - 12°        | 19.3"                        | 62mm           | 2.8 x 3"     | 12.5 oz. |
| AF28-300mm f/3.5-5.6 XR IF Di         | 13/15               | 75° - 8°         | 19.3"                        | 62mm           | 2.9 x 3.3"   | 14.8 oz. |
| AF70-300mm f/4.0-5.6 LD Macro         | 13/9                | 34° - 8°         | 4.9' (3.1' in macro mode)    | 62mm           | 3 x 4.6"     | 15.3 oz. |
| SP AF200-500mm f/5-6.3 Di LD IF       | 10/13               | 12° - 5°         | 98.4"                        | 62mm           | 3.7 x 8.9"   | 43.6 oz. |

ORDER & INFO. (212) 502-6340 • FAX: (212) 239-7770 (800) 947-7008  
**1-800-290-6750 • www.bhphotovideo.com**



# TOKINA

## MANUAL FOCUS LENSES

### WIDE ANGLE & TELEPHOTO ZOOM LENSES

#### **MF 28-70mm f/3.9-4.8 II**

This compact lightweight lens is designed for use with manual focus camera bodies. It is perfect for beginning photographers, photo students who are required to use manual focus equipment, and photographers looking for a lighter, smaller alternative to older bulky lenses. The optics are made from glass provided by Hoya Corporation, the worlds largest optical glass manufacturer, and have multi-coating applied to the elements to reduce or eliminate reflections that can cause image degrading flare and ghosting. The lens has an excellent close focusing ability of just 13.4" that yields a macro ratio of 1:4.

For Canon FD (TO287039C) .....124.95 For Nikon AI (TO287039N) .....124.95  
For Minolta MD (TO287039M) .....124.95 For Pentax PK (TO287039N) .....124.95

#### **MF 28-105mm f/3.5-4.8**

This all-purpose lens will provide the avid shooter with a convenient, compact 28-105mm wide-angle to moderate telephoto focal range in a lightweight package. It's "two touch" rotary zoom design and all metal lens barrels give this lens excellent handling and durability at an affordable price. It also offers a 1:5 macro ratio for interesting close-ups. The creative capabilities are only limited by your imagination.

For Canon FD (TO2810535CQ) .....189.95 For Pentax PK (TO2810535PQ) .....189.95  
For Minolta MD (TO2810535MQ) .....189.95 For Yashica Contax (TO2810535CYQ) ..189.95  
For Nikon AI (TO2810535N) .....189.95 For Olympus (TO2810535OQ).....189.95



#### **MF 28-200mm f/3.5-4.3**

With a zoom ratio of over 7:1, this remarkable manual focus lens covers all focal lengths required for virtually any situation. It is less than 4.3" long and weighs only 24.3 oz. Photographic applications range from landscapes and portraits to sports. Made from traditional all metal barrels and all glass optics, this lens will provide years of dedicated service.

For Canon FD (TO2820035C) .....219.95 For Pentax PK (TO2820035P) .....219.95  
For Minolta MD (TO2820035M).....219.95 For Yashica Contax (TO2820035CY)....219.95  
For Nikon AI (TO2820035N).....219.95 For Olympus (TO2820035O) .....219.95

#### **MF 60-300mm f/4-5.6**

A useful 5x manual focus zoom that covers the entire range from 60mm standard to 300mm telephoto. This lens can easily handle many aspects of photography. The "one touch" zoom/focus operation gives it excellent handling and range of magnifications in a compact body.

For Canon FD (TO603004C) .....179.95 For Pentax PK (TO603004P) .....179.95  
For Minolta MD (TO603004M) .....179.95 For Nikon AI (TO603004N) .....179.95

#### **MF 70-210mm f/4.5-5.6**

Barely 3.43" long and 15 oz. in weight, this is one of the world's smallest telephoto zoom lenses. It's one-touch system holds focus throughout the zoom, it's size is perfect for fast moving hand-held photography, and it's range makes it suitable for a wide range of applications.

For Canon FD (TO7021045C) .....124.95 For Nikon AI (TO7021045N).....124.95  
For Minolta MD (TO7021045M).....124.95 For Pentax PK (TO7021045P) .....124.95

# TOKINA

## AUTOFOCUS LENSES

AT-X (Advanced Technology-Xtra) signifies a special group of lenses that are manufactured without compromise. Combining advanced design and fabrication technology with a unique optical configuration system developed by Tokina, has made advanced features, high performance, light weight and compact designs possible. Tokina's proprietary AT-X lens technology has evolved toward optical perfection for nearly 20 years. They have made continuous improvements and each new model is a further refinement of previous designs and materials. The current PRO series, recognizable by their distinctive Gold rings, continues this evolution.



CAMERAS & LENSES

179

### The Tokina Difference:

#### Mechanisms:

- All metallic moving parts are coated with a special lubricant to improve durability
- Tokina's independently developed technology maintains the high precision of mechanical fittings, accurately measured in microns
- Micron tolerances also give smooth operation and durability to operating rollers and internal focus cams
- Brass is used in the lens mount to maintain high precision. Other mechanisms are plated with hard chrome for optimum durability

#### Exterior Finish:

- PRO models have a hardened Armalite finish to increase durability and give a top-quality feel and finish

- Ergonomic designs emphasize control, grip and ease of operation with textured rubber used on zoom and focus barrels.

#### Operation:

- Use of special alloy Duralumin for metal parts provides excellent durability, stabilizes torque and provides better handling. It also maintains smoother operation under all conditions.
- A special lubricant formulated to perform even under extreme temperatures, is used on moving parts
- Unique lens coating makes the lenses resistant to flare and ghosting, and helps them achieve faithful color reproduction

## AT-X PRO FIXED FOCAL LENGTH LENSES



### AF 17mm f/3.5 AT-X Pro

This super wide angle lens features Tokina's exclusive "Focus Clutch Mechanism" for faster, smoother auto focus as well as smooth manual focus. It also features a floating element auto focus system for high resolution and contrast, an all glass aspherical lens element, and all aluminum lens barrels with a chrome-plated, brass mount plate. The lens elements are made of higher quality HLD (high refraction, low dispersion) glass to provide even illumination across the whole film plane and prevent light fall-off. Filter size is 77mm.

For Canon (TO1735PCAF) .....389.95      For Nikon (TO1735PNAF) .....389.95  
 For Minolta (TO1735PMAF) .....389.95

### AF 300mm f/2.8 AT-X Pro IRF

Features the exclusive "Focus Clutch Mechanism" for auto and manual focusing that is much faster and smoother than other lenses. As with all Tokina AT-X AF lenses, this lens is constructed using all aluminum lens barrels and a chrome-plated, brass mount plate. The first lens group is made from two elements of high quality SD (Super Low Dispersion) glass to minimize chromatic aberration. The patented Internal Rear Focus (IRF) system moves smaller lens groups within the lens barrel, which is useful for long telephoto lens designs. The IRF system also allows faster auto focusing and a more compact lens design.

For Canon (TO30028PCAF) .....2299.95      For Nikon (TO30028PNAF) .....2299.95  
 For Minolta (TO30028PMAF) .....2299.95



ORDER & INFO. (212) 502-6340 • FAX: (212) 239-7770 (800) 947-7008  
**1-800-290-6750 • www.bhphotovideo.com**



# TOKINA

## AUTOFOCUS LENSES

### AT-X PRO ZOOM LENSES

#### AF 20-35mm f/2.8 AT-X Pro IF

Just look through the viewfinder and see the world in a dramatic new perspective. An ultra wide-angle zoom, the AF 20-35mm produces edge-to-edge razor-sharp images, while the fast f/2.8 aperture makes picture taking indoors or at dusk—effortless. Additional features include two (the front and rear) molded multi-coated aspherical elements, and the exclusive “Focus Clutch Mechanism”. In addition, IF (Internal Focus) means filter threads don’t move during focusing. The advantage is when a special effects filter is used, it isn’t necessary to readjust the position of the filter every time the focus is changed. Like all Tokina AT-X AF lenses the AF 20-35mm f/2.8 AT-X Pro is constructed using an all aluminum lens barrel and a chrome-plated brass mount plate. Lens elements are made of high-quality HLD (high refraction, low dispersion) glass for high resolution and contrast. Filter size is 77mm.



|  |               |                                       |               |
|--|---------------|---------------------------------------|---------------|
| <b>For Canon</b> (TO203528CAF) .....   | <b>479.95</b> | <b>For Nikon</b> (TO203528NAF) .....  | <b>479.95</b> |
| <b>For Minolta</b> (TO203528MAF) ..... | <b>479.95</b> | <b>For Pentax</b> (TO203528PAF) ..... | <b>479.95</b> |

#### AF 28-70mm f/2.8 AT-X Pro SV

This lens provides a constant wide f/2.8 aperture for excellent low light photography at any focal length in the zoom range. The wide aperture allows more light through to the camera for taking pictures in difficult lighting situations, or for use of faster shutter speeds to either reduce vibrations or capture fast action. Also, constant aperture lenses make manual strobe calculations easier. With the increased use of non-corrosive materials this lens will give you years of use. Filter size is 77mm.

|  |               |
|--|---------------|
| <b>For Canon</b> (TO287028ACA) .....   | <b>249.95</b> |
| <b>For Nikon</b> (TO287028AND) .....   | <b>249.95</b> |
| <b>For Minolta</b> (TO287028AMA) ..... | <b>249.95</b> |
| <b>For Pentax</b> (TO287028APE) .....  | <b>249.95</b> |



#### AF 28-80mm f/2.8 AT-X Pro

Constructed of the highest-quality optical glass, this lens uses two aspherical lens elements and one SD (super low dispersion) glass element to insure critical sharpness across the film plane. In addition to outstanding optical quality, it offers conveniences such as a window showing a distance scale. This makes it possible to tell the focusing distance, regardless of the actual setting of the focus mode. Redesigned Focus Clutch Mechanism allows the focus ring to be snapped back to the manual focus position at anytime. This means you don’t have to change the AF/MF switch every time the lens is switched from auto to manual focus. Filter size is 77mm.

|  |               |
|--|---------------|
| <b>For Canon</b> (TO288028CAF) .....   | <b>519.00</b> |
| <b>For Nikon</b> (TO288028NAF) .....   | <b>519.00</b> |
| <b>For Minolta</b> (TO288028MAF) ..... | <b>519.00</b> |
| <b>For Pentax</b> (TO288028PAF) .....  | <b>519.00</b> |

#### AF 80-200mm f/2.8 AT-X Pro

Built to professional specifications, the AF 80-200mm f/2.8 provides uniformly high image quality from infinity to close focus using a unique floating element system that separately focuses the first three and last two elements in the forward lens groups. It also uses SD (Super-Low Dispersion) glass to minimize chromatic aberration. Tokina’s exclusive “Focus Clutch Mechanism” assures top performance during auto and manual focusing, while a new exterior finish improves overall handling and durability. Filter size is 77mm.



|   |               |  |               |
|---|---------------|--|---------------|
| <b>For Canon</b> (TO8020028PCA) .....   | <b>609.95</b> | <b>For Nikon</b> (TO8020028PNA) .....  | <b>609.95</b> |
| <b>For Minolta</b> (TO8020028PMA) ..... | <b>609.95</b> | <b>For Pentax</b> (TO8020028PPA) ..... | <b>609.95</b> |

# TOKINA

## AUTOFOCUS LENSES

### AT-X ZOOM LENSES

#### AF 19-35mm f/3.5-4.5

One of Tokina's most popular lenses, the AF19-35mm f/3.5-4.5 uses high refraction, low dispersion (HLD) glass and multi-coated lens elements for outstanding performance in a value-priced lens. It offers easy handling, since it is compact and there is no change in overall length when zooming. Special filters can also easily be used because the front filter thread doesn't rotate. Lens barrel is made from black polycarbonate to reduce overall weight, making it convenient to carry. Filter size is 77mm.

**For Canon (TO193535CAFQ).....169.95**      **For Nikon (TO193535NAFQ) .....169.95**  
**For Minolta (TO193535MAFQ).....169.95**      **For Pentax (TO193535PAF).....169.95**



CAMERAS & LENSES

181



#### AF 24-200mm f/3.5-5.6 ATX IF

The ultimate traveling lens, the AF 24-200mm is currently the widest zoom range available. It is constructed using a chrome plated brass mount plate and a combination of aluminum and composite lens barrels to reduce weight while maintaining strength and durability. Optically, the lens uses two Aspherical lens elements and one SD (Super Low Dispersion) glass element to ensure sharpness across the film plane. Internal Focusing (IF) mechanism gives this lens fast auto focus and means the filter threads don't move during focusing. This allows special effects filter such as a circular polarizer to be used. Focus distance is indicated on the manual focus ring. Like the rest of the lenses in the AT-X series, the AF 24-200mm is a parafoveal lens, meaning, when focus is achieved at a telephoto focal length, you can zoom back to wide angle and maintain focus. Filter size is 72mm.

**For Canon (TO2420035CAF).....299.95**      **For Nikon (TO2420035NAF) .....299.95**  
**For Minolta (TO2420035MAF).....299.95**      **For Pentax (TO2420035PAF).....299.95**

#### AF 80-400mm f/4.5-5.6 ATX II

A complete range of lenses in one! The AF 80-400mm has an incredibly compact design for its enormous zoom focal length range and is ideal for those who don't want to lug around huge zoom lenses—but still want the flexibility to take long range sport or nature shots. Specialized features for this lens include a supplied tripod clamp that is rotatable for landscape or portrait shots, and a zoom lock. By locking the zoom at its shortest (80mm) setting, the lens can be carried comfortably suspended at the camera. SD (Super Low Dispersion) glass reduces chromatic aberration for high contrast shots of maximum definition with any color fringe. High quality is also achieved with the bayonet hood and internal "flare cutter". Filter size is 72mm.

**For Canon (TO8040045TCC).....489.95**      **For Nikon (TO8040045TCN).....489.95**  
**For Minolta (TO8040045TCM).....489.95**      **For Pentax (TO8040045TCP) .....489.95**



### AF LENS SPECIFICATIONS

|                    | 17mm      | 300mm           | 20-35mm   | 28-70mm   | 28-80mm   | 80-200mm  | 19-35mm  | 24-200mm  | 80-400mm  |
|--------------------|-----------|-----------------|-----------|-----------|-----------|-----------|----------|-----------|-----------|
| Minimum Focusing   | .82'      | 7.9'            | 1.64'     | 1.65'     | 1.6'      | 5.9'      | 1.3'     | 2.9'      | 2.5m      |
| Focusing System    | Internal  | Internal (rear) | Internal  | Internal  | Internal  | Internal  | Internal | Internal  | Rotary    |
| Filter Size        | 77mm      | 112/35.5mm      | 77mm      | 77mm      | 77mm      | 77mm      | 77mm     | 72mm      | 72mm      |
| Supplied Lens Hood | BH-773    | MH-112N         | BH-773    | BH-776    | BH-775    | MH-774N   | BH-774   | BH-723    | BH721     |
| Supplied Case      | Soft Case | Hard Case       | Soft Case | Soft Case | Soft Case | Hard Case | —        | Soft Case | Soft Case |

ORDER & INFO. (212) 502-6340 • FAX: (212) 239-7770 (800) 947-7008  
**1-800-290-6750 • www.bhphotovideo.com**



# VIVITAR

## V3800N

SLR CAMERAS

182

### 35mm Manual Focusing SLR Camera

An inexpensive all-manual SLR built on a Pentax K-mount chassis known for reliability, the V3800N includes a self-timer, a depth-of-field preview and the ability to shoot multiple exposures on a single frame. The venerable K-mount assures that a ready supply of sharp, reasonably priced lenses (both new and used) is available for the camera. Powered via two 1.5v alkaline or silver batteries, the shutter is operable without battery power at all speeds up to 1/2000 of a second.



#### FEATURES

- ◆ Easy to use manual SLR camera ideal for the first-time SLR user
- ◆ Depth of field preview
- ◆ Multiple exposure capability
- ◆ Bright viewfinder with split image focusing and three-LED display
- ◆ Hot shoe with x-contact for flash photography, synchronized at 1/125 second or slower
- ◆ Film speed range: ISO 25 to 3200
- ◆ Accurate center-weighted, TTL metering system
- ◆ Self timer with 10 second delay
- ◆ Takes regular mechanical cable release
- ◆ Only available in kits which include a 50 mm f/1.7 lens or 28-70mm f/3.4-4.8, a camera case, and with or without the Vivitar 2000 Auto Flash

**V3800N Camera Kit (VIV3800N5017)**  
Includes V3800N camera, 50mm f/1.7 lens and camera case .....**139.95**

**V3800N Camera Kit (VIV38005017K)**  
Includes V3800N camera, 50mm f/1.7 lens, camera case and 2000 Auto Flash .....**149.95**

**V3800N Camera Kit (VIV3800N2870)**  
Includes V3800N camera, 28-70mm f/3.4-4.8 lens and camera case ..... **159.95**

**V3800N Camera Kit (VIV38002870K)**  
Includes V3800N camera, 28-70mm f/3.4-4.8 lens, camera case and 2000 Auto Flash...**169.95**

**Lens Mount:** "K" Type Bayonet

**Exposure & Focus Modes:** Manual

**Exposure Metering:** Centerweighted LED

**Metering Range:** EV 2-19 @ ISO 100 with f/1.7 lens)

**Shutter Speed:** 1/2000 to 1 Second + bulb with flash sync at 1/125 of a second

**ISO Range:** 25-3200 (manually set)

**Film Wind:** Manual

**Focusing Screen:** Fixed matte with horizontal split image

**PC Terminal:** Yes

**Depth-of-Field Preview:** Yes

**Multiple Exposure:** Yes

**Power Source:** Two 1.5v LR44/SR44 alkaline or lithium batteries

**Dimensions:** 5.3 x 2.3 x 2.0" (WxHxD)

**Weight:** 0.98 lb

## FIXED FOCAL LENS



### 100mm f/3.5 Macro AF and Manual Focus Lenses

With an aperture range of f/3.5-22, a macro ratio of 1:1 and a minimum focusing distance of 1.4', this lens is designed for high detail macro photography. It's also flexible enough to be good for portrait photography and is available in all popular SLR camera mounts. Superior optical performance is ensured with 5 elements in 4 groups, and with multi-coated optics to reduce flare and increase light transmission. Filter size is 49mm.

#### MANUAL LENSES

For Canon FD (V110035MC) .....**119.95**      For Pentax PK (V110035MP) .....**119.95**

For Nikon AI (V110035MN).....**119.95**      For Contax/Yashica (V110035MCY) ..**119.95**

For Olympus (V110035MO) .....**119.95**

#### AF LENSES

For Canon EOS (V110035MCAF).....**149.95**      For Minolta Maxxum (V110035MMAF) ..**139.95**

For Nikon AF (V110035MNAF) .....**139.95**      For Pentax AF (V110035MPAF).....**139.95**



[www.bhphotovideo.com](http://www.bhphotovideo.com)

# VIVITAR

## T-MOUNT LENSES

### 500mm f/8 Manual Focus Mirror Reflex Lens

Ideal for sports and nature photography, the economical and compact 500mm f/8 features a 30.5mm rear filter system and is available with a wide selection of Vivitar T-mount lens adapters. Minimum focusing distance is 5.5'.

|  |        |   |        |
|--|--------|---|--------|
| For Canon FD (VI5008C) .....             | 109.95 | For Minolta MD (VI5008M).....             | 109.95 |
| For Canon EOS (VI5008CAF).....           | 109.95 | For Nikon (VI5008NAF).....                | 109.95 |
| For Contax/Yashica (VI5008CY).....       | 109.95 | For Olympus (VI5008O).....                | 109.95 |
| For Konica (VI5008K).....                | 109.95 | For Pentax PK (VI5008P).....              | 109.95 |
| For Minolta Maxxum (VI5008MAF).....      | 109.95 | For Universal Screw Mount (VI5008PU)..... | 109.95 |
| Without T-mount (required) (VI5008)..... | 99.95  |   |        |



### 600-1000mm f/9.9-16 Super Telephoto

#### AF and Manual Focus Zoom Lens with 2x Teleconverter



Ideal for long range wildlife and sports photography, this T-mount lens offers smooth one-touch zoom control and is multi-coated for reduced flare and increased light transmission. But it doesn't stop there. It also includes a 2x converter—transforming the lens into an incredible 1200 -2000mm super telephoto zoom lens. (Minimum focus without the 2x is 13'.) T-mount adapter included.

|  |        |  |        |                                 |        |
|--|--------|--|--------|---------------------------------|--------|
| For Canon FD (VI6001000C) .....              | 299.95 | For Konica (VI6001000K) .....          | 299.95 | For Nikon (VI6001000N) .....    | 299.95 |
| For Canon EOS (VI6001000CAF).....            | 299.95 | For Minolta Maxxum (VI6001000MAF)..... | 299.95 | For Olympus (VI6001000O).....   | 299.95 |
| For Contax/Yashica (VI6001000CY).....        | 299.95 | For Minolta MD (VI6001000M).....       | 299.95 | For Pentax PK (VI6001000P)..... | 299.95 |
| For Universal Screw Mount (VI6001000PU)..... | 299.95 |  |        |                                 |        |

SLR CAMERAS

183

## ZOOM LENSES

### 19-35mm f/3.5-4.5 Series 1 Ultra Wide-Angle AF and Manual Focus Zoom Lens

With an aperture range of f/3.5-22 and a minimum focusing distance of 1.6', this compact and lightweight lens is the perfect wide angle partner to any SLR camera. Available in all popular SLR camera mounts. Filter size is 77mm.

#### MANUAL LENSES

|                                      |        |                                 |        |
|--------------------------------------|--------|---------------------------------|--------|
| For Canon FD (VII93535C).....        | 139.95 | For Minolta MD (VII93535M)..... | 139.95 |
| For Contax/Yashica (VII93535CY)..... | 139.95 | For Pentax PK (VII93535P).....  | 139.95 |
| For Nikon AI (VII93535N) .....       | 139.95 | For Olympus (VII93535O).....    | 139.95 |

#### AF LENSES

|                                  |        |                                      |        |
|----------------------------------|--------|--------------------------------------|--------|
| For Canon EOS (VII93535CAF)..... | 179.95 | For Minolta Maxxum (VII93535MAF) ... | 159.95 |
| For Nikon AF (VII93535NAF) ..... | 159.95 | For Pentax AF (VII93535PAF) .....    | 159.95 |

### 28-80mm f/3.5-5.6

#### Manual Focus Wide-Angle Zoom Lens

This manual focus zoom lens, with an aperture range of f/3.5-22 and a minimum focusing distance of 2.8', is ideal for wide angle closeups. It has enough zoom range for moderate portraiture, and is available in many popular camera mounts. Filter size is 58mm.

|                                       |       |                                   |       |
|---------------------------------------|-------|-----------------------------------|-------|
| For Canon FD (VII288035C).....        | 99.95 | For Nikon AI (VII288035N) .....   | 99.95 |
| For Contax/Yashica (VII288035CY)..... | 99.95 | For Minolta MD (VII288035M) ..... | 99.95 |
| For Pentax PK (VII288035P).....       | 99.95 |                                   |       |



ORDER & INFO. (212) 444-5027 • FAX: (212) 239-7770 (800) 947-7008  
1-800-947-9927 • www.bhphotovideo.com



# VIVITAR

## ZOOM LENSES

### 28-210mm f/3.5-5.6 High Performance Manual Focus Wide-Angle Zoom Lens

With an aperture range of f/3.5-22 and a macro ratio of 1:4, this lens is an ideal addition to any photographer's bag of tricks. The 7x zoom provides versatile performance. Filter size is 72mm.

|  |               |   |               |
|--|---------------|---|---------------|
| <b>For Canon FD</b><br>(VI2821035C).....   | <b>139.95</b> | <b>For Olympus</b><br>(VI2821035O) .....        | <b>139.95</b> |
| <b>For Nikon AI</b><br>(VI2821035N) .....  | <b>139.95</b> | <b>For Contax/Yashica</b><br>(VI2821035CY)..... | <b>139.95</b> |
| <b>For Minolta MD</b><br>(VI2821035M)..... | <b>139.95</b> | <b>For Pentax PK</b><br>(VI2821035P) .....      | <b>139.95</b> |

### 28-210mm f/4.2-6.5 Series 1 Autofocus Wide-Angle Zoom Lens

With an aperture range of f/4.2-22 and a macro ratio of 1:6, this lens is a great addition for any photographer. The 7x zoom provides versatile performance. Minimum focusing distance is 1.6'. Filter size is 67mm.

|  |               |   |               |
|--|---------------|---|---------------|
| <b>For Canon EOS</b><br>(VI2821042CAF) ..... | <b>189.95</b> | <b>For Minolta Maxxum</b><br>(VI2821042MAF) ..... | <b>179.95</b> |
| <b>For Nikon AF</b><br>(VI2821042NAF).....   | <b>179.95</b> | <b>For Pentax AF</b><br>(VI2821042PAF) .....      | <b>179.95</b> |

### 28-300mm f/4.0-6.3 Series 1 Autofocus Wide-Angle Zoom Lens

This lens offers the widest zoom range available (over 10x) today in a single autofocus lens. Compact and lightweight, it is ideal for the traveler who wants to carry one lens and still cover virtually every photographic situation with ease. Minimum focusing distance is 1.6'. Filter size is 67mm.

|  |               |  |               |
|--|---------------|--|---------------|
| <b>For Canon EOS</b> (VI283004CAF).....      | <b>209.95</b> | <b>For Nikon AF</b> (VI283004NAF)..... | <b>199.95</b> |
| <b>For Minolta Maxxum</b> (VI283004MAF)..... | <b>199.95</b> |  |               |



### 70-210mm f/4.5-5.6 AF & Manual Focus Telephoto Zoom

An exceptionally compact and lightweight telephoto zoom lens with macro focusing as close as 1:4x. It delivers superior optical performance with 12 elements in 8 groups, has a one-touch focus and zoom control, and is multicoated for reduced flare and increased light transmission. It is ideal for sports and wildlife photography. Filter size is 52mm.

|  |               |  |              |
|--|---------------|--|--------------|
| <b>For Canon EOS</b> (VI7021045CAF) .....      | <b>119.95</b> | <b>For Nikon AI</b> (VI7021045N) .....   | <b>99.95</b> |
| <b>For Nikon AF</b> (VI7021045NAF) .....       | <b>99.95</b>  | <b>For Minolta MD</b> (VI7021045M) ..... | <b>99.95</b> |
| <b>For Minolta Maxxum</b> (VI7021045MAF) ..... | <b>99.95</b>  | <b>For Pentax K</b> (VI7021045P) .....   | <b>99.95</b> |
| <b>For Canon FD</b> (VI7021045C) .....         | <b>99.95</b>  |  |              |

### 100-300mm f/5.6-6.7 AF & Manual Focus Telephoto Zoom

An affordable telephoto zoom ideal for sports and wildlife photography, the 100-300mm is also exceptionally compact and lightweight for a zoom with this reach. Multicoated for reduced flare and increased light transmission, it features one-touch focus and zoom control, and macro focusing as close as 1:4x and fast f/5.6 aperture. Filter size is 52mm.

|   |               |   |               |
|---|---------------|---|---------------|
| <b>For Canon EOS</b> (VI10030056CA) .....   | <b>124.95</b> | <b>For Canon FD</b> (VI10030056CM) .....  | <b>109.95</b> |
| <b>For Nikon AF</b> (VI10030056NA) .....    | <b>114.95</b> | <b>For Nikon AI</b> (VI10030056NM) .....  | <b>109.95</b> |
| <b>For Min. Maxxum</b> (VI10030056MA) ..... | <b>114.95</b> | <b>For Minolta MD</b> (VI10030056MM)..... | <b>109.95</b> |
| <b>For Pentax AF</b> (VI10030056PA) .....   | <b>114.95</b> | <b>For Pentax K</b> (VI10030056PM) .....  | <b>109.95</b> |





# VIVITAR

## ZOOM LENSES

### 100-400mm f4.5-6.7 AF Telephoto Zoom Lens

With a maximum magnification of 8x, this lens allows you to capture distant subjects with ease. A must for the long range shooter, the 100-400mm lens allows you to capture distant subjects with ease. Available in all popular SLR camera mounts, it offers precision auto focus performing at longer focal lengths and smooth one-touch zoom control. Minimum focusing distance is 6.5'.

- For Canon EOS (VI10040045CA) .....229.95
- For Nikon AF (VI10040045NA) .....209.95
- For Minolta Maxxum (VI10040045MA) .....209.95
- For Pentax AF (VI10040045PA) .....229.95

### Manual Extension Tube Set

Full automatic diaphragm and meter coupling operation. Set includes 12mm, 20mm and 36mm extenders. Extenders use internal baffles to eliminate stray light.

- For Canon FD (VIETSC) .....94.95
- For Minolta MD (VIETSM) .....94.95
- For Nikon AI (VIETSN) .....94.95
- For Pentax K (VIETSP) .....94.95



100-400mm  
f/4.5-6.7  
AF  
Telephoto  
Zoom Lens

Manual  
Extension  
Tubes

### 2x Teleconverter

2x magnification, 4 elements, multi-coated lens. Includes case and protective lens cap.

- For Canon EOS (VI2XCAF) .....89.95
- For Contax/Yashica (VI2XCY) .....49.95
- For Minolta Maxxum (VI2XMAF) .....89.95
- For Minolta MD (VI2XM) .....49.95
- For Nikon AF (VI2XNAF) .....89.95
- For Pentax/Ricoh (VI2XP) .....49.95



### Series 1 2x Teleconverter

2x magnification, 7 elements, multi-coated lens. Includes case and protective cap.

- For Canon EOS (VI2XCAFQ) .....119.95
- For Minolta Maxxum (VI2XMAFQ) .....119.95
- For Nikon AF (VI2XNAFQ) .....119.95

CAMERAS & LENSES

185

|                             | Minimum Focus Distance       | Magnification                       | Angle of View | Length                     | Weight   | Filter Size              |
|-----------------------------|------------------------------|-------------------------------------|---------------|----------------------------|----------|--------------------------|
| 100mm f/3.5 Macro Manual    | 1.4'                         | 1:2 (1:1 with life-size attachment) | 25°           | 2.6"                       | 0.57 lb. | 49mm                     |
| 100mm f/3.5 Macro AF        | 1.4'                         | 1:2 (1:1 with life-size attachment) | 24°           | 2.7"                       | 9.5 oz.  | 49mm                     |
| 500mm f/8                   | 5'                           | 1:2.7                               | 5°            | 3.4"                       | .79 lb.  | 30.5mm rear              |
| 19-35mm f/3.5-4.5           | 1.6'                         | 1:6.8                               | 97 to 63°     | 2.8"                       | 0.69 lb. | 77mm                     |
| 28-80mm f/3.5-5.6           | 2.8'                         | 1:4                                 | 75 to 30°     | 2.9"                       | 0.64 lb. | 58mm                     |
| 28-210mm f/3.5-5.6          | 8.2'<br>(3.6' in macro mode) | 1:4                                 | 75 to 11°     | 4.4"                       | 1.18 lb. | 72mm                     |
| 28-210mm f/4.2-6.5 Series 1 | 1.7'                         | 1:6.8                               | 75 to 11°     | 3.9"                       | 0.87 lb. | 67mm                     |
| 28-300mm f/4.0-6.3 Series 1 | 6.2'                         | 1:5.5                               | 75 to 8°      | 4.8"                       | 1.25 lb. | 77mm                     |
| 70-210mm f/4.5-5.6 Manual   | 3.8'                         | 1:4                                 | 34 - 12°      | 3.4"                       | 15.9 oz. | 52mm                     |
| 70-210mm f/4.5-5.6 AF       | 4.4'                         | 1:5                                 | 34.3 - 11.8°  | 4"                         | 14.6 oz. | 55mm                     |
| 100-300mm f/5.6-6.7 Manual  | 4.9'                         | 1:4                                 | 24 to 8°      | 5.3"                       | 1.1 lb.  | 52mm                     |
| 100-300mm f/5.6-6.7 AF      | 4.9'                         | 1:4                                 | 24 to 8°      | 5.5"                       | 1.1 lb.  | 55mm                     |
| 100-400mm f/4.5-6.7         | 6.5'                         | 1:4                                 | 24 to 6.4°    | 6.3"                       | 25.9 oz. | 67mm                     |
| 600-1000mm f/9.9-16         | 14.4'                        | N/A                                 | 4.1-2.5°      | 12.6" at its smallest size | 1.85 lb. | 72mm (77mm on lens hood) |

ORDER & INFO. (212) 502-6340 • FAX: (212) 239-7770 (800) 947-7008  
1-800-290-6750 • www.bhphotovideo.com



# VOIGTLANDER

## BESSA R

CAMERAS & LENSES

186

### Manual Focus 35mm Rangefinder Camera

The Bessa R is composed of an all aluminum die-cast metal casing with a streamlined body that fits comfortably into the palm of your hand. It is extremely durable with excellent corrosion resistance. The combination rangefinder/viewfinder has framelines for 35, 50, 75 and 90mm lenses-and makes a good approximation of a 28mm lens by using the whole viewfinder. The overall brightness and clarity of the split image is nearly equal the Leica M6, and actually brighter than a Leica M2 or M3. It is also parallax corrected.



- ◆ Incorporates a Leica 39mm screw lens mount, so it can accept lenses from Leica, Canon, Contax, Voigtlander and others
- ◆ Changing of focal lengths is done manually and the double mechanical shutter is quiet, reliable and won't be damaged by the sun.
- ◆ Manual focus and exposure modes
- ◆ TTL centerweighted light metering (range is EV 1-19 @ ISO 100 with 50mm f/1.5 lens)
- ◆ 1 to 1/2000 shutter speed + bulb, with flash sync at 1/125 second
- ◆ Clear LED exposure scale with red for under/overexposure and green for correct exposure
- ◆ Exceptionally bright viewfinder with split image rangefinder patch and brightlines for 35, 50, 75 & 90mm lenses
- ◆ ISO range is ISO 25-3200 (manually set)
- ◆ Manual film transport using superb and unobtrusive rewind knob
- ◆ 10-second self-timer
- ◆ Hot flash shoe and PC terminal
- ◆ Accepts diopters for the Nikon FM10
- ◆ Accepts standard mechanical cable release
- ◆ Powered by two 1.5v LR44 alkaline batteries
- ◆ Measures 5.3 x 3.1 x 1.3" (WxHxD); it weighs 0.87 lb.

**Bessar R Silver Body (VOBR)** .....299.95

**Bessar R Black Body (VOBRB)** .....299.95

**Case for Bessa-R Standard (VOCBR)** .....39.95

**Case for Bessa-R Snout (VOCBRs)**.....34.95

## BESSA R2A/BESSA R3A

### Manual Focus 35mm Rangefinder Cameras



A great alternative to the Leica M, Konica Hexar RF and Contax G-Series cameras, the Bessa R2A and R3A use Leica's M mount, plus they offer automatic aperture-priority exposure (metered manual exposure is also possible), Trigger Winder capability, and comfortable ratcheted film advance. Compatible with most standard Leica M bayonet lenses or screw mount lenses with an adapter, they feature improved body covering like magnesium-cast top and bottom covers and scratch-resistant splatter paint finish. They also offer a superior rubberized and anodized metal body, as well as internal parts made of metal instead of plastic (as on the Bessa R). The Bessa R2A and R3A are solid and durable, while the textured rubber will "hold" onto your hand. They are also exceptionally comfortable cameras

to hold and carry, due to the very graspable body covering and the molded palm grip on the back door.

Identical except for the finders, the R2A has a .7 magnification finder with 35/50/75/90 framelines while the R3A has a 1:1 finder with 40/50/75/90 framelines. This makes the Bessa 3A the first Leica M mount camera with a life size 1:1 finder!

The life size view finder allows you to shoot comfortably and effectively with both eyes open at the same time!



**ONE HOUR FREE PARKING**  
AT 349 W. 34th STREET (with purchase of \$100 or more)

# VOIGTLANDER

## BESSA R2A/BESSA R3A

- ◆ Leica M-type lens mount accepts M bayonet-type lenses from Leica, Minolta and Konica as well as all 39mm screw mount lenses from Canon, Leica & Voigtlander—with an optional adapter.
- ◆ Aperture priority automatic exposure—you set the lens aperture, the camera sets the shutter speed.
- ◆ Electronic shutter with 1 to 1/2000 shutter + bulb manually selected speeds, 8-1/2000 on AE and flash sync at 1/125 second. (Like most electronic shutters, there is no manual speed back up if the batteries die.)
- ◆ Shutter speed LED readout from 1-2000 at the bottom of the finder.
- ◆ TTL centerweighted light metering for ambient light (range is EV 1-19 @ ISO 100 with 50mm f/1.5 lens )
- ◆ Metering in Manual or AE with AE Exposure Lock
- ◆ ISO range is ISO 25-3200 (manually set)
- ◆ ±2 stop exposure compensation on AE
- ◆ Ratcheting film advance, 45° standoff and 120° advance stroke
- ◆ Rotating shutter lock on shutter release; heavy duty rewind knob
- ◆ Compatible with the Voigtlander Trigger Winder for fast, battery-free film advance. With practice you can shoot 3 frames per second without the battery dependency of a motor drive (you can still use the top mounted shutter release). The Trigger Winder also provides a comfortable grip, as strap lugs for mounting the camera vertically rather than horizontally.
- ◆ Powered by two 1.5v LR44 alkaline batteries. Low batteries are indicated by blinking LEDs.
- ◆ Hot flash shoe and PC terminal
- ◆ Accepts diopters for the Nikon FM10
- ◆ They measure 5.4 x 3.2 x 1.4" (WxHxD); and weigh 1 lb.
- ◆ No self-timer

**Bessa-R2A (0.7x Viewfinder)**  
**Black Body (VOBR2A) .....\$49.95**  
**Bessa-R3A (1.0x Viewfinder)**  
**Black Body (VOBR3A) .....\$49.95**  
**Case for Bessa-R Standard (VOCBR) ..\$39.95**  
**Case for Bessa-R Snout (VOCBR3) ...\$34.95**

**CAMERAS & LENSES**

**187**

### LEICA M-MOUNT RANGEFINDER LENSES

A standard Leica M-mount is used for these lenses, making them compatible with the Bessa R2A and R3A cameras as well as the Konica Hexar RF and Leica M cameras.

#### 35mm f/1.2 Wide Angle Nokton (VO3512B)

This extremely fast wide-angle lens, the 35mm f/1.2 has an aspherical design to minimize distortion common with wide-angle lenses, and features an all-metal lens barrel construction and a 12-bladed aperture diaphragm which creates very pleasing out-of-focus highlights. Full rangefinder coupling is retained, and the aperture ring has click stops at half-stop intervals. Includes lens hood. Filter size is 52mm.....**879.95**



#### 35mm f/2.5-M Wide Angle Color-Skopar Pan (PII) (VO3525P2B)

The tiny Color-Skopar 35mm f/2.5 lens features an all-metal lens barrel construction and a 10-bladed aperture diaphragm which creates pleasing out-of-focus highlights. Click stop aperture movements at half-stop intervals makes subtle adjustments in exposure or depth-of-field easy. Filter size is 39mm.....**339.95**

#### 40mm f/1.4 Nokton Classic (VO4014B)

Especially prized, the 40mm focal length provides the best and most natural perspective for the 35mm 24x36 format. Extremely fast, the 40 f/1.4 has 7 elements in 6 groups, is rangefinder coupled, and has a close focus of .7 meters. Its dimensions are 1.15 x 2.15" and it weighs 6.1 oz.....**379.95**



### M-LENS SPECIFICATIONS

|              | Groups/Elements | Picture Angle | Minimum Focus | Maximum Diameter | Length | Weight  |
|--------------|-----------------|---------------|---------------|------------------|--------|---------|
| 35mm f/1.2   | 7/10            | 63°           | 2.3'          | 2.5"             | 3"     | 1.1 lb. |
| 35mm f/2.5-M | 5/7             | 63°           | 2.3'          | 2.2"             | 23mm   | 4.7 oz. |
| 40mm f/1.4   | 6/7             | 56°           | 2.3'          | 2.2"             | 1.15"  | 6.1 oz. |

**ORDER & INFO. (212) 502-6340 • FAX: (212) 239-7770 (800) 947-7008**  
**1-800-290-6750 • www.bhphotovideo.com**



# VOIGTLANDER

## L (LEICA 39mm) SCREWMOUNT LENSES

### *For Bessa R or the R2A/R3A with Optional Adapter*

These lenses use a standard L-mount, making them compatible with the Bessa R as well as classic cameras from Leica and Canon with the venerable 39mm screwmount design. If you want to use these lenses with the Bessa R2A and R3A, Leica M, or Konica Hexar RF cameras, they require the optional M-Bayonet adapter ring.

#### **12mm f/5.6 Ultra Wide Aspherical Heliar with Viewfinder**

This non-fisheye lens has an amazing 121° angle of view, making it ideal for stunning landscape photography as well as dramatic interiors. Even when shooting with the aperture wide open, the lens will yield high contrast and excellent resolution. A 9-bladed aperture diaphragm creates very pleasing out-of-focus highlights. Click-stops on the aperture movement at half-stop intervals, make it easy to make subtle adjustments in exposure or depth-of-field. It has no rangefinder coupling because it's extremely wide depth of field does not require it. The lens comes with a bright dedicated viewfinder, featuring a high eye-point design allowing you to see the entire image area while wearing glasses. Includes a viewfinder and lens hood. Filter size is 77mm (with optional filter adapter).

12mm f/5.6 Ultra Wide Heliar with Viewfinder: Silver color (VO1256S) .....599.00

12mm f/5.6 Ultra Wide Heliar with Viewfinder: Black color (VO1256B) .....599.00

Filter adapter to allow use of 77mm filters on the 12mm f/5.6 Heliar lens (VOFA) .....69.95



#### **15mm f/4.5 Super-Wide Aspherical Heliar Lens with Viewfinder**

This lens has a 110° angle of view and is ideal for stunning landscape photography as well as situations requiring a wide angle lens such as tight interiors. It includes a viewfinder.

15mm f/4.5 Super-Wide Heliar with Viewfinder: Silver color (VO1545S) .....349.95

15mm f/4.5 Super-Wide Heliar with Viewfinder Black color (VO1545B) .....349.95

#### **21mm f/4.0 Wide Angle Color-Skopar with Viewfinder**

With the attached focus assister you go from minimum distance to infinity in less than 90° of rotation. Apertures are selected with the click-stop diaphragm. It includes a viewfinder and a lens hood. Filter size is 39mm

21mm f/4 Wide Angle Color-Skopar with Viewfinder: Silver color (VO214S) .....339.95

21mm f/4 Wide Angle Color-Skopar with Viewfinder: Black color (VO214B) .....339.95



#### **25mm f/4.0 Wide Angle Snapshot Skopar with Viewfinder**

The Skopar, a radical lens desired by many camera enthusiasts, makes a return as a super-sharp, dedicated snapshot lens. Designed for fast and easy use, this lens has click-stops on the focus ring, which makes estimating focus distance quick and simple. A unique multi-coating reduces flare and ghost while maintaining excellent image quality. Has a built-in focus click-stop mechanism, a powerful feature in snapshot photography. Includes a 25mm viewfinder and a lens hood. Filter size is 39mm.

25mm f/4 Wide Angle Snapshot Skopar with Viewfinder: Silver color (VO254S) .....249.00

25mm f/4 Wide Angle Snapshot Skopar with Viewfinder: Black color (VO254B) .....249.00

# VOIGTLANDER

## L (LEICA 39mm) SCREWMOUNT LENSES

CAMERAS & LENSES

189

### 28mm f/3.5 Wide Angle Color Skopar

The Color-Skopar 28mm f/3.5 features an all-metal lens barrel construction and a 10 bladed aperture which creates pleasing out-of-focus highlights. This lens retains rangefinder and viewfinder coupling with all the combinations. Viewfinder sold separately. Filter size is 39mm.

28mm f/3.5 Wide Angle Color Skopar: Silver color (VO2835C) .....289.95  
 28mm f/3.5 Wide Angle Color Skopar: Black color (VO2835B).....289.95



### 28mm f/1.9 Wide Angle Ultron

This ultrafast wideangle lens is a leader in speed for this focal length. With the attached focus assister you go from minimum distance to infinity in less than 90° of rotation. Apertures are selected with the click-stop diaphragm. This lens retains rangefinder coupling with all the combinations, and when used with Leica's 0.58x and 0.72x M-series cameras as well as the Konica Hexar RF, will trigger the appropriate viewfinder window. Excellent depth of field scale. Viewfinder sold separately. Filter size is 46mm.

28mm f/1.9 Wide Angle Ultron: Silver color (VO2819S) .....449.95  
 28mm f/1.9 Wide Angle Ultron: Black color (VO2819B) .....449.95

### 35mm f/1.7 Wide Angle Ultron Aspherical

A nice fast optic for the 39mm screwmount rangefinder cameras from Voigtlander, Leica and Canon. It features an all-metal lens barrel construction and a 10-bladed aperture diaphragm which creates very pleasing out-of-focus highlights. Full rangefinder coupling is retained, and the aperture ring has click stops at half-stop intervals. This lens retains rangefinder and viewfinder coupling with all the combinations. Includes a lens hood. Viewfinder sold separately. Filter size is 39mm.

35mm f/1.7 Wide Angle Ultron: Silver color (VO3517S) .....384.95  
 35mm f/1.7 Wide Angle Ultron: Black color (VO3517B) .....384.95



### 35mm f/2.5 Wide Angle Color-Skopar C (Classic)

This lens features an all-metal lens barrel construction and a 10-bladed aperture which creates pleasing out-of-focus highlights. Click-stop aperture movement delineated in half-stop intervals makes subtle adjustments in exposure or depth-of-field simple. This lens retains rangefinder and viewfinder coupling with all the combinations. Has a permanently attached circular lens hood. Filter size is 39mm.

35mm f/2.5 Wide Angle Color Skopar: Silver color (VO3525CS) .....229.95  
 35mm f/2.5 Wide Angle Color Skopar: Black color (VO3525CB).....229.95

### 50mm f/1.5 Normal Nokton

A fast optic for 39mm screwmount rangefinder cameras, the Nokton features all-metal lens barrel construction and a 10 bladed aperture diaphragm which creates pleasing out-of-focus highlights. Click stop aperture movements at half-stop intervals makes subtle adjustments in exposure or depth-of-field easy. The Nokton lens is unusual in the rangefinder field because of the use of modern aspherical lens element fabrication technology on the rear element. The lens is constructed with two aspherical surfaces and one SD (super-low dispersion) glass element. This lens retains rangefinder and viewfinder coupling with all the combinations. Viewfinder sold separately. Filter size is 52mm.

50mm f/1.5 Normal Nokton: Silver color (VO5015S) .....349.95  
 50mm f/1.5 Normal Nokton: Black color (VO5015B) .....349.95



ORDER & INFO. (212) 502-6340 • FAX: (212) 239-7770 (800) 947-7008  
 1-800-290-6750 • www.bhphotovideo.com



# VOIGTLANDER

## L (LEICA 39mm) SCREWMOUNT LENSES

CAMERAS & LENSES

190

### 50mm f/2.5 Normal Color-Skopar Classic

This Color-Skopar 50mm f/2.5 features an all-metal lens barrel construction and a 10-bladed aperture which creates pleasing out-of-focus highlights. This lens retains rangefinder and viewfinder coupling with all the combinations. Viewfinder sold separately. Filter size is 52mm.

50mm f/2.5 Normal Color-Skopar Classic: Silver color (VO5025C) .....289.95  
 50mm f/2.5 Normal Color-Skopar Classic: Black color (VO5025B) .....289.95



### 75mm f/2.5 Telephoto Color Heliar

The Color Heliar has all-metal lens barrel construction and a 10-bladed aperture diaphragm which creates pleasing out-of-focus highlights. Click stop aperture movement at half-stop intervals makes subtle adjustments in exposure or depth-of-field easy. This lens retains rangefinder and viewfinder coupling with all combinations. Viewfinder sold separately. Includes lens hood. Filter size is 43mm.

75mm f/2.5 Telephoto Color Heliar: Silver color (VO7525S) .....299.95  
 75mm f/2.5 Telephoto Color Heliar: Black color (VO7525B) .....299.95

### 90mm f/3.5 APO Lanthar

This unique lens allows all three components of the light spectrum (infrared, visible light and ultraviolet) to pass through it, tremendously increasing the sharpness and contrast of pictures and making this lens basically irreplaceable for photographers interested in infrared, black and white and specialty photography. Lens barrel construction is a metallic affair, and a 10-bladed aperture creates pleasing unfocused highlights. Features click-stop aperture movement at half-stop intervals. This lens retains rangefinder and viewfinder coupling with all combinations. Includes lens hood. Viewfinder sold separately. Filter size is 39mm.

90mm f/3.5 Telephoto APO Lanthar: Silver color (VO9035S) .....319.95  
 90mm f/3.5 Telephoto APO Lanthar: Black color (VO9035B) .....319.95



## Lens Hoods

Lens hoods are primarily designed to prevent unwanted stray light from entering the lens by extending and shading the end of the lens. In addition, since the end of the lens is extended, you also get the added benefit of some extra protection from accidental impact.



**Rectangular Metal Lens Hood (VOLH1)**  
 For 21mm, 25mm and 28mm Lenses .....49.95



**Rectangular Metal Lens Hood (VOLH2)**  
 For 35mm and 50mm Lenses .....49.95

## M-Bayonet Adapter Rings

Required to use the above L (Leica 39mm) screw-mount lenses with the Voigtlander Bessa R2A and R3A, Leica M, or Konica Hexar RF cameras.



**M-Bayonet Adapter Ring (VOMBAR35)**  
 For 35mm and 135mm Screw-Mount Lenses .....59.95

**M-Bayonet Adapter Ring (VOMBAR50)**  
 For 50mm and 75mm Screw-Mount Lenses .....59.95

**M-Bayonet Adapter Ring (VOMBAR28)**  
 For 28mm and 90mm Screw-Mount Lenses .....59.95



EQUIPMENT LEASING AVAILABLE

# VOIGTLANDER

## ACCESSORIES

### VC Light Meter II



A small, lightweight accessory meter that serves older Leicas and similar rangefinder cameras. The meter conveniently slips into the camera's shoe while readings are taken. Three

dials - one for ISO, one for aperture and one for shutter speed allow settings to be made. A series of LEDs illuminate when correct measurement has been achieved.

- VC Light Meter II (VOM2S) Silver .....199.95
- VC Light Meter II (VOM2B) Black.....189.95
- Strap Adapter for VC Meter (VOSAVC) ..39.95

### Rapid Trigger Winder (VOW)



A valuable accessory, the winder can be skillfully operated for a film advance rate of up to three frames per second. You can leave the winder on the camera and still change the film. Built-in side grip. Three strap lugs for horizontal or vertical carrying. Tripod socket .....199.95

**Bubble Level (VOBL)**  
Fits into camera's shoe.....129.95

**Side Grip for Bessa Cameras (VOG)**  
Screws into tripod socket .....49.95

**Bottom Grip A (Straight) for Bessa Cameras (VOGBA)**  
Provides a handy vertical bottom grip to any rangefinder camera. Connects to the 1/4-20" tripod socket at the bottom of the camera .....39.95



**Bottom Grip B (Ball) for Bessa Cameras (VOGBB)**  
Provides a handy ball-shaped bottom grip for any rangefinder camera. Connects to the 1/4-20" tripod socket at the bottom of the camera .....39.95

### Double Shoe Adapter Type A (VODSAA)

Dual-mounting adapter allows the VC Light Meter II to be used slightly offset on top of the camera with a viewfinder attached directly over the camera flash shoe.....59.95



### Angle Viewfinder for Bessa-R Cameras

with 12mm, 15mm, 21mm or 25mm Lenses (VOVFA)

This first device of its kind, the Angle Viewfinder makes composition of vertical and horizontal pictures with Voigtlander's superwide lenses (which fit all Leica screwmount cameras) easy. Included is a rear built-in diopter, parallax

compensation marks, and a clear bright view.....199.95

### Attachment for Angle Viewfinder

**12mm Attachment for Angle Viewfinder (VOA12VF):** This 12mm adapter is required to make the Angle Viewfinder compatible with a 12mm lens.....84.95

**15mm Attachment for Angle Viewfinder (VOA15VF):** This 15mm adapter is required to make the Angle Viewfinder compatible with a 15mm lens.....69.95

**21mm Attachment for Angle Viewfinder (VOA21VF):** This 21mm adapter is required to make the Angle Viewfinder compatible with a 21mm lens.....69.95

**25mm Attachment for Angle Viewfinder (VOA25VF):** This 25mm adapter is required to make the Angle Viewfinder compatible with a 25mm lens.....69.95

### Viewfinders with Brightlines

These viewfinders have parallax correction marks and a bright, stellar image.

#### Viewfinder with Brightlines

**For 28mm Lens (VOVF28B):**  
Black color .....169.95

**Viewfinder with Brightlines For 28mm Lens (VOVF28S):**  
Silver color .....169.95

**Viewfinder with Brightlines For 35mm Lens (VOVF35B):**  
Black color .....169.95

**Viewfinder with Brightlines For 35mm Lens (VOVF35S):**  
Silver color .....169.95

**Viewfinder with Brightlines For 28mm and 35mm Lens (VOMF2835B):**  
Black color .....199.99

**Viewfinder with Brightlines For 28mm and 35mm Lens (VOMF2835S):**  
Silver color .....199.99

**Viewfinder with Brightlines For 40mm Lens (VOVF40B):**  
Black color .....129.95

**Viewfinder with Brightlines For 50mm Lens (VOVF50B):**  
Black color .....129.95

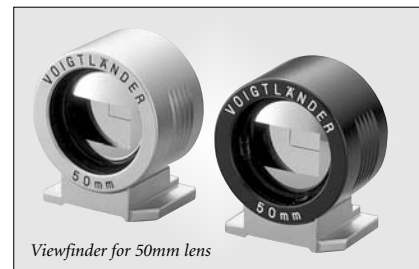

Viewfinder for 50mm lens

**Viewfinder with Brightlines For 50mm Lens (VOVF50S):**  
Silver color .....129.95

**Viewfinder with Brightlines For 75mm Lens (VOVF75B):**  
Black color .....129.95

**Viewfinder with Brightlines For 75mm Lens (VOVF75S):**  
Silver color .....129.95

**Viewfinder with Brightlines For 90mm Lens (VOVF90B):**  
Black color .....169.95

**Viewfinder with Brightlines For 90mm Lens (VOVF90S):**  
Silver color .....169.95

# VOIGTLANDER

## BESSA R2S • BESSA R2C

CAMERAS & LENSES

192

### Manual Focus 35mm Rangefinder Cameras



Basically the same as the Bessa R2A without automatic exposure, the Bessa R2S has a classic Nikon Rangefinder lens mount while the R2C has a classic Contax Rangefinder lens mount (both are based on a the mount introduced in 1932 on the Zeiss Contax 1). The Bessa R2S will accept the Voigtlander S or SC lenses, or any of the Nikon Rangefinder lenses (except 21mm f/4 ). It also accepts some classic Contax rangefinder lenses, but with restrictions. The Bessa R2C will accept the Voigtlander SC lenses, or most of the classical Contax rangefinder\* lenses. This camera will also accept some Nikon rangefinder lenses, but with restrictions.

\*Note: they are not compatible with the modern "G" mount and does not accept Contax G lenses.

### BESSAFLEX™ Manual Focus 35mm Screwmount SLR Camera

Available in black or silver, the Beassaflex™ is the first camera in decades to utilize the once predominant "Universal" 42mm lens screw mount. Designed to fulfill a market demand for a simple mechanical single lens reflex camera in the popular 42mm Pentax screw mount, the Bessaflex™ is an ideal camera for students and beginner photographers attending photo schools where a mechanical SLR camera is required. The camera features rugged die cast body, extremely bright viewfinder, light meter, self timer, TTL flash socket, stop-down switch for through the lens light metering and depth of focus assessment. The film door of camera is equipped with window for type-of-film viewing. The fully mechanical shutter will work without batteries.



#### FEATURES

- ◆ Pentax "Universal" 42mm screw mount
- ◆ Manual focus, manual exposure
- ◆ Camera provides TTL "stop-down" metering activated by the Meter Switch, ideally placed to be operated by your left thumb as you hold and focus the camera. (Meter Switch only works with "Auto" diaphragm lenses.
- ◆ Doesn't have a shoe mount (can be added as an accessory); has a PC terminal
- ◆ Extremely bright viewfinder
- ◆ Depth-of-preview via the Metering Switch
- ◆ Top shutter speed of 1/2000 second
- ◆ 10-second self-timer
- ◆ Accepts standard mechanical cable release
- ◆ Powered by 2 included LR-44 1.5v batteries
- ◆ Compact and lightweight (only 1.1 lb.)

|  |   |
|--|---|
| <b>Bessaflex™<br/>Manual Focus Camera Body (VOBTMB)</b><br>Black color.....  | <b>Flash Shoe Adapter<br/>for Bessaflex™ (VOSABS)</b><br>This adapter allows a shoe flash to be mounted to the Bessaflex™ body, and links up to the PC socket to provide TTL metering ..... |
| <b>Bessaflex™<br/>Manual Focus Camera Body (VOBTMS)</b><br>Silver color..... | .....   |
| <b>Voigtlander Case for Bessaflex™ (VOCBS)</b> .....                         | .....   |
|  |   |





# VOIGTLANDER

## BESSAFLEX™ SLR LENSES

### 12mm f/5.6 Ultra Wide-Heliar SL

#### with Viewfinder (VO1256SL)

A unique, non-fisheye lens designed for Nikon cameras equipped with mirror lock-up system. It features a Nikon bayonet mount, metal body with high quality finish, aspherical lens element and comes with dedicated viewfinder and front/rear lens caps .....**889.00**

### 15mm f/4.5 Super Wide-Heliar SL

#### with Viewfinder (VO1545SL)

The metal 15mm f/4.5 lens is a non-fisheye lens for Nikon cameras equipped with a mirror lock-up system. It features Nikon bayonet mount, an aspherical lens element and comes with dedicated viewfinder and front/rear lens caps .....**589.99**

### Ultron 40mm f/2.0 SL

#### Aspherical Manual Focus Lens (VO402SL)

A top quality metal lens that delivers exceptionally sharp pictures even at fully opened diaphragm. It features an aspherical lens element and has front and rear lens caps. Available in Nikon AIS, Canon FD, Pentax K, Minolta MD, Contax / Yashica MM, Olympus OM and Pentax 42mm screw mount .....**289.99**

### Color Heliar 75mm f/2.5 SL

#### Manual Focus Lens (VO7525SLPE)

The metal 75mm f/2.5 Color-Heliar features a mount for the optional square metal hood and comes with front and rear lens caps. The lens is available in Nikon AIS, Canon FD, Pentax K, Minolta MD, Contax / Yashica MM, Olympus OM and Pentax 42mm screw mount.....**289.99**

### APO-Lanthar 90mm f/3.5 SL

#### Close Focus Lens (VO9035SLPE)

This lens features a metal body with high quality finish, close focus that gives 3.5x magnification, mount for the optional square metal hood and lens comes with front and rear lens caps. Available in Nikon AIS, Canon FD, Pentax K, Minolta MD, Contax / Yashica MM, Olympus OM and Pentax 42mm screw mount .....**299.99**

### Macro APO-Lanthar 125mm f/2.5 SL

#### Manual Focus Lens (VO12525SLPE)

This metal lens features a high quality finish, macro, square metal hood and lens comes with front and rear lens caps. Available in Nikon AIS, Canon FD, Pentax K, Minolta MD, Contax / Yashica MM, Olympus OM and Pentax 42mm screw mount .....**659.99**

### APO-Lanthar 180mm f/4.0 SL

#### Manual Focus Lens (VO1804SLPE)

The metal APO-Lanthar 180mm f/4.0 lens features a close focus, mounts for the optional square metal hood and front and rear lens caps. The lens is available in Nikon AIS, Canon FD, Pentax K, Minolta MD, Contax / Yashica MM, Olympus OM and Pentax 42mm screw mount.....**359.99**

## BESSAFLEX™ LENS SPECIFICATIONS

|             | Minimum Focus Distance | f/Stop Range | Angle of View | Length | Weight   | Filter Size |
|-------------|------------------------|--------------|---------------|--------|----------|-------------|
| 12mm f/5.6  | 1'                     | 5.6-22       | 121°          | 0.6"   | 7 oz.    | 77mm*       |
| 15mm f/4.5  | 1'                     | 4.5-22       | 110°          | 0.5"   | 5.3 oz.  |             |
| 40mm f/2.0  | 1.3'                   | 2-16         | 57°           | 5.1"   | 9 oz.    | 52mm        |
| 75mm f/2.5  | 2.3'                   | 2.5-22       | 32°           | 1.6"   | 8.8 oz.  | 49mm        |
| 90mm f/3.5  | 1.6'                   | 3.5-22       | 27°           | 2.3"   | 13.7 oz. | 49mm        |
| 125mm f/2.5 | 15"                    | 2.5-22       | 20°           | 3.5"   | 1.5 lb.  | 58mm        |
| 180mm f/4.0 | 4'                     | 4-22         | 14°           | 3.1"   | 1.1 lb.  | 49mm        |



## L SCREWMOUNT LENS SPECIFICATIONS

|            | Minimum Focus Distance | f/Stop Range | Angle of View | Length | Weight   | Filter Size |
|------------|------------------------|--------------|---------------|--------|----------|-------------|
| 12mm f/5.6 | 11.8"                  | 5.6-22       | 121°          | 1.5"   | 0.20 lb. | 77mm*       |
| 15mm f/4.5 | 1'                     | 4.5-22       | 110°          | 1.2"   | 0.23 lb. |             |
| 21mm f/4.0 | 1.6'                   | 4.0-22       | 90.9°         | 1.1"   | 0.24 lb. | 39mm        |
| 25mm f/4.0 | 2.3'                   | 4.0-22       | 82°           | 1.2"   | 0.20 lb. | 39mm        |
| 28mm f/3.5 | 27.5"                  | 3.5-22       | 75°           | 1.01"  | 5.75 oz. | 39mm        |
| 28mm f/1.9 | 2.3'                   | 1.9-22       | 75°           | 2.5"   | 0.58 lb. | 46mm        |
| 35mm f/1.7 | 3'                     | 1.7-16       | 63°           | 1.8"   | 0.44 lb. | 39mm        |
| 35mm f/2.5 | 2.9'                   | 2.5-22       | 63°           | 1.2"   | 0.29 lb. | 39mm        |
| 50mm f/1.5 | 3'                     | 1.5-16       | 46°           | 2.2"   | 0.53 lb. | 52mm        |
| 50mm f/2.5 | 29.5"                  | 2.5-22       | 46°           | 1.3"   | 7.3 oz.  | 39mm        |
| 75mm f/2.5 | 3.3'                   | 2.5-16       | 32°           | 2.5"   | 0.50 lb. | 43mm        |
| 90mm f/3.5 | 3.3'                   | 3.5-22       | 27°           | 3.5"   | 0.57 lb. | 39mm        |

CAMERAS & LENSES

193

ORDER & INFO. (212) 502-6340 • FAX: (212) 239-7770 (800) 947-7008  
1-800-290-6750 • www.bhphotovideo.com







# The 35mm SLR Photo

SourceBook

## Section 2

### Underwater Cameras

|                  |         |
|------------------|---------|
| Nikonos .....    | 196-199 |
| Sealife.....     | 200     |
| Sea & Sea .....  | 201-203 |
| Ikelite .....    | 204-211 |
| Ewa Marine ..... | 212-213 |

# NIKON

## NIKONOS V

UNDERWATER

196

### 35mm Underwater Camera

You'll marvel at the thrill of capturing the underwater world on film with a Nikonos V. The easy answer to quality underwater photography, your first experience with the Nikonos V will show you how easy it is to take great exposures automatically with TTL flash exposure. Pictures come out crisp and colorful, thanks to the optically superb variety of interchangeable lenses that you will want for creative imaging. Oversized, highly visible controls are simple to operate. Right from your very first photo dive, you'll get incredible photographic results and enjoy diving even more. The venerable Nikonos V is the most complete interchangeable lens underwater camera system in the world. With the ability to dive down to 160' and five lenses from fisheye to telephoto, your photos will only be limited by your opportunities and creativity.



### FEATURES

- ◆ A 35mm underwater camera that doesn't require special housing, the easy-to-use Nikonos V features a rugged but compact die-cast body with all joints sealed by O-ring gaskets. This allows it to operate and withstand the pressure at 50 meters (160')
- ◆ Designed for ease of use you can choose Aperture Priority automatic exposure which lets you set the desired aperture while the camera selects the corresponding shutter speed. There is also a Manual mode for complete control.
- ◆ ISO options from 25 to 1600 and shutter speeds ranging from 1/30 to 1/1000 of a second including "M90" for mechanical backup shutter release of 1/90 second, and "B" for bulb.
- ◆ Automatic TTL flash control capability enables error-free underwater flash photography with the optional Nikon SB-104 and SB-105 Speedlights
- ◆ Synchro-sunlight or exposure compensation possible with SB-104 and SB-105 for creating original exposures
- ◆ Complete system includes the SB-104 and SB-105 TTL Speedlight, in addition to optical underwater viewfinders, underwater frame finders, close-up outfits and Nikkor underwater/land-use lenses; these Speedlights also enable TTL multi-flash capability with other Speedlights via Double Flash Bracket and Double Sync Cord.

### The Nikonos V's Brain

The Nikonos V uses micro-electronics technology for accurate data analysis and computation as well as for precise operation execution—all aimed at realizing correct exposure. Easy-to-operate aperture priority auto exposure metering, manual exposure metering, performance-proven TTL center-weighted metering, highly advanced automatic TTL underwater flash metering, and quartz-timed accurate shutter speed control on manual.

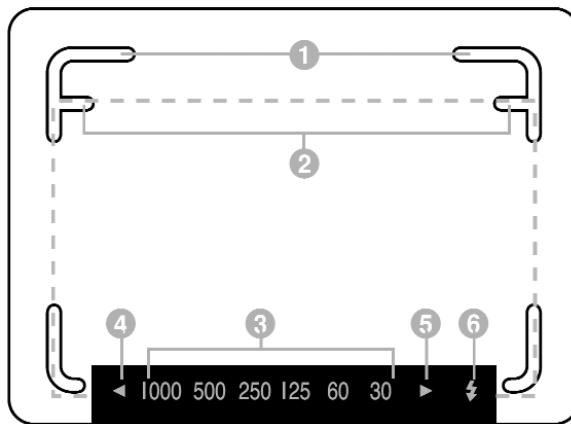

- 1) Film frame mark
- 2) Parallax compensation mark
- 3) Shutter speed scale
- 4) Over exposure warning mark
- 5) Underexposure/camera shake warning mark
- 6) Flash ready-light mark

1) Denotes the area of coverage with a 35mm lens underwater. Picture coverage is 85% (at infinity) of the actual area, so note that the actual exposed area will be broader than the area covered by this frame. When shooting to within 0.8m of the subject, parallax might cause the subject to fall out of the film area actually shot; to avoid this, you should position the subject image under the 2) mark and within the broken red line.



# NIKON

## NIKONOS LENSES

UNDERWATER

197

### 15mm f/2.8N UW-Nikkor IC Lens (NI1528UW)

When the action is fast-moving and your subject is large - such as dolphins - or you want to capture the total feeling of the coral reef, there's the 15mm (underwater use only) lens. It provides incredibly sharp images down to 12", with a 94° angle of view. Optional DF-11 Optical Viewfinder is exclusively designed for use with this lens .....IMP. 1449.95 /USA 2069.95

### 20mm f/2.8 UW-Nikkor IC Lens (NI2028UW)

For wide-angle subjects that are difficult to approach, the 20mm (underwater use only) provides a 78° wide view with a larger image magnification capability for dramatic appeal. Great for up-close shooting to 1.3'. Underwater corrected for optimum sharpness. Optional DF-12 Optical Viewfinder helps confirm exact picture coverage .....IMP. 719.95 /USA 889.95

### 28mm f/3.5 UW-Nikkor IC Lens (NI2835UW)

The ideal tool for taking close-ups of fish, schools of fish, or other divers. The 28mm (underwater use only) offers a 59° angle of view and focuses as close as 2'. The DF-12 optional Optical Viewfinder can be used with the supplied mounting mask for confirming exact coverage with this lens. Catch a whole school of fish in one shot .....IMP. 339.95 /USA 449.95

### 35mm f/2.5 W-Nikkor IC Lens (NI3525UW)

General-purpose amphibious lens. Camera's viewfinder matches lens field of view. Great for all active water sports. Picture angle of 43° at 30' underwater (62° on land). Recommended lens for use with extension tubes for underwater macro photography. 1:4.5 reproduction ratio with close-up outfit .....IMP. 179.95 /USA 239.95

### 80mm f/4.0 W-Nikkor IC Lens (NI804UW)

Amphibious telephoto lens that's perfect for close-ups with the Nikonos Close-Up Outfit (1:2 life-size reproduction. Picture angle 22° at 45' underwater (30° on land). Optional DF-10 Optical Viewfinder used for on-land photography .....IMP. 339.95 /USA 449.95

### UW Close-Up Outfit (NICUKC)

Creative, close focusing tools for intimate portraits of coral reef creatures. Consists of a close-up attachment lens mounted in front of a 28mm, 35mm, or 80mm lens. Three field frames match the area covered by these lenses. A camera-mounted frame support bracket helps determine precise camera-to-subject distance. Variable underwater magnification ratio - 1:6 (28mm), 1:4 (35mm) and 1:2.2 (80mm). Includes a compartment case .....USA 299.95

USA= Imported & Warrantied by Nikon USA

IMP. = Imported & Warrantied by B&H (not qualified for Nikon USA rebates and warranties)



15mm  
f/2.8N



20mm  
f/2.8



35mm f/2.5



80mm f/4.0

|                           | 15mm f/2.8N | 20mm f/2.8 | 28mm f/3.5 | 35mm f/2.5 | 80mm f/4.0 |
|---------------------------|-------------|------------|------------|------------|------------|
| Filter Size               | 86mm        | 67mm       | 58mm       | 58mm       | 58mm       |
| f/stop Range              | 2.8-22      | 2.8-22     | 3.5-22     | 2.5-22     | 4-22       |
| Minimum Focusing Distance | 1'          | 1.3'       | 2'         | 2.6'       | 3.3'       |
| Angle of View             | 94°         | 78°        | 59°        | 43°        | 23°        |
| Groups/Elements           | 9/12        | 7/9        | 5/6        | 5/7        | 5/5        |
| Length                    | 3.6"        | 2.9"       | 1.7"       | 1.5"       | 2.6"       |
| Maximum Diameter          | 3.7"        | 2.7"       | 2.4"       | 2.4"       | 2.4"       |
| Weight                    | 2.3 oz.     | 12 oz.     | 6 oz.      | 6 oz.      | 10 oz.     |

ORDER & INFO. (212) 502-6340 • FAX: (212) 239-7770 (800) 947-7008  
1-800-290-6750 • www.bhphotovideo.com



# NIKON

## NIKONOS SPEEDLIGHTS

UNDERWATER

198

Perhaps the most amazing experience on a coral reef is witnessing its extraordinary colors. But beneath the waves, colors lose their brilliance and everything takes on a bluish tint. Restore these dramatic hues by using a Nikonos SB-104 or SB-105 Speedlight. Automatic through-the-lens (TTL) flash control enables you to paint the underwater setting with light, rendering a palette of unimaginable colors. The camera's TTL sensor precisely monitors the amount of light reflected off the subject for optimum flash exposure, so there's no need for guesswork or complicated calculations. Manual flash exposure is always available for situations in which photographers want to control the exposure.

### SB-104 UW TTL Speedlight

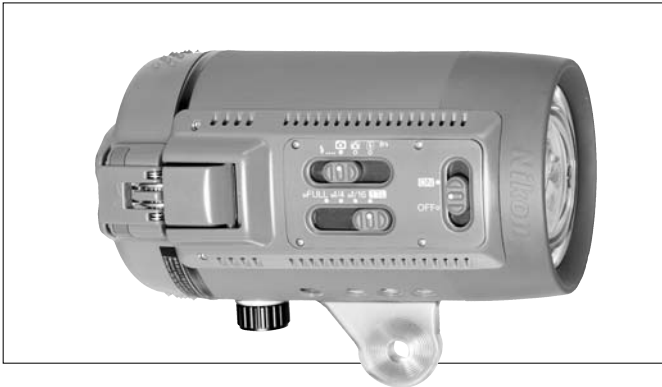

A high-performance flash unit designed to complement the Nikonos V. Underwater guide number 53 at ISO 100 with 100° flash coverage. Fast recycling time of only 3 seconds. Versatile flash controls: choose TTL Auto or manual flash output control (full, 1/4 or 1/16 power.) Powered by optional SN-104 Nicad Battery Pack.

- ◆ Automatic TTL flash control provides optimum flash exposure
- ◆ Powerful Guide Number of 53 (feet at ISO 100)
- ◆ Wide flash coverage, covers picture angle of a 15mm underwater lens
- ◆ Take it tot the extreme. Rugged design allows the SB-104 to withstand pressure at 320 feet
- ◆ Wireless slave flash capability lets you use a second SB-104 for added dimension and power that is so critical during close up photography
- ◆ Measures 8.7 x 4.9" and weighs 70 oz (18 oz. underwater) without batteries
- ◆ Full range of accessories provide total flash control
- ◆ Optional (required) SN-104 Nicad Pack provides up to 120 full power flashes with quick recycle time of 3 seconds at full power. SH-104 Nicad Charger can charge two SN-104 packs at one time. Quick charges each battery in two hours. Runs on 110v/220v 50Hz/60Hz AC.

#### SB-104 UW TTL Speedlight Set (NISB104)

Includes a SK-104A Standard Arm, SK-104B Standard Bracket, UW Sync Cord, O-Ring Set and a 1-Year Warranty .....**1199.95**

#### SB-104 UW TTL Speedlight - Flash Head Only (NISB104H)

Includes a 1-Year Warranty .....**999.95**

### SB-105 UW TTL Speedlight



An affordable underwater flash for the Nikonos V, the SB-105 is a medium powered TTL unit with 70° coverage. It features automatic TTL flash control for perfect exposures, has 3 manual settings (full, 1/4 or 1/16 power), recycles quickly, and gives approx. 120 firings per set of batteries. Supplied with battery holder, flash adapter, O-ring set, UW Sync cord, mounting bracket set. Requires 4 AA batteries.

- ◆ Automatic TTL flash control provides optimum flash exposure
- ◆ Guide Number is 33 in (feet at ISO 100) underwater
- ◆ Rugged design allows the SB-105 to withstand the pressure at 320'
- ◆ When used with the supplied SW-103 Wide Flash Adapter, it covers the picture angle of a 15mm lens.
- ◆ Wireless slave flash capability lets you use a second SB-105 for added dimension and power that is so critical during close up photography
- ◆ Full range of accessories including sync cords and brackets provide total flash control
- ◆ Measures 3.9 x 5.1 x 7.1" and weighs 61 oz. (5.3 oz. underwater) without batteries

#### SB-105 UW TTL Speedlight Set (NISB105)

Includes an MS-105 AA Battery Holder, Arm, Bracket, Joint, UW Sync Cord, Cord Fastening Hanger, Wide Flash Adapter SW-103, O-Ring Set, Exposure Calculation Chart and 1-Year Warranty .....**CALL**

#### SB-105 UW TTL Speedlight - Flash Head Only (NISB105H)

Includes an SW-103 wide adapter .....**CALL**



**EQUIPMENT LEASING AVAILABLE**



# NIKON

## NIKONOS ACCESSORIES

**SK-104 Mounting Bracket Set (NISK104):**  
Connect an SB-104 Speedlight to a Nikonos camera. Consists of an SK-104A Flash Arm and an SK-104B Flash Bracket .....**209.95**



SK-104A

**SK-104A Flash Arm (NISK104A):**  
Holds a Nikonos SB-104 Speedlight. Use with a Flash Bracket SK-104B or a Double Flash Bracket SK104W.....**132.95**

**SK-104B Flash Bracket (NISK104B):**  
For Nikonos SB-104 and SB-105. Use with Flash Arm SK-104A/SK-104C .....**99.95**

**SK-104W Double Flash Bracket (NISK104W):**  
For SB-104 and SB-105. It allows two flash units to be used simultaneously. Use with SK-104A or SK-104C Flash Arms .....**224.95**

**SK-104C Flash Arm (NISK104C):**  
Used to attach an SB-104 Speedlight to an SK-104B Flash Bracket or SK-104W Double Flash Bracket .....**119.95**

**SK-104E Extension Arm (NISK104E):**  
For Nikonos SB-104. This 10" extension arm improves flexibility and increases reach. Use with Flash Arm SK-104A .....**199.95**

**Supporting Arm for SB-105 (NISASB105):**  
A replacement arm that is used to hold a Nikonos SB-105.....**119.95**

**Mounting Bracket for SB-105 (NIBSB105):**  
The Supporting Arm for the Nikonos SB-105 attaches to this bracket .....**34.95**

**Arm Joint for SB-105 (NIAJSB105):**  
Used to attach a Nikonos SB-105 to a Nikonos arm.....**74.95**

**Double Flash Bracket (NIBDSB105):**  
Allows two SB-105 flash units to be used simultaneously. Requires Nikonos Supporting Arms.....**149.95**

**10" Extension Arm (NIEASB105):**  
For the SB-105. Improves flexibility and increases reach.....**99.95**

**SC-SB105 Single UW TTL Sync Cord (NISCBS105):** Connects a Nikonos SB series strobe to a Nikonos camera..... **79.95**



SC-100



SC-102

**SC-100 Double TTL Sync Cord (NISC100):**  
For SB-104 and SB-105. It allows two flash units to be used simultaneously.....**149.95**

**SC-101 TTL Sync Cord (NISC101):**  
Single UW openwater sync cord connects to SB-104/105 (requires SC-103 Cord) ....**124.95**

**SC-101 TTL Sync Cord Set (NISC101S):**  
Allows SB-104 and SB-105 Speedlights to be charged underwater, TTL only underwater. Use with Nikonos V and Connecting Cord SC-103 (included).....**258.50**

**SC-102 Double TTL Sync Cord (NISC102):**  
For SB-104 and SB-105. Allows two flash units to be used and charged simultaneously, TTL only underwater. Use with Nikonos V and Connecting Cord SC-103 .....**169.95**



TTL Cord

**SC-103 Connecting Cord (NISC103):**  
For SB-104 and SB-105. Allows two flash units to be charged underwater. For Nikonos V and SC-101 or SC-102 sync cords....**146.95**

**Nikonos SC-102/103 Set (NISC102S):**  
Includes SC-102 Double TTL Sync Cord and SC-103 Connecting Cord .....**299.95**

**TTL Cord (NISCNUWSB103):**  
For Nikonos V (for use above water only). Allows conventional flash units to be used in TTL setting. For all flash units with ISO-flash mount.....**CALL**

**Nicad Battery Pack for SB-104 (NISN104):**  
Fully charges in 2 hours with the SH-104 charger .....**129.95**

**SH-104 Nicad Battery Charger for SN-104 Battery Pack (NISH104) .....269.95**

**Aquatica Flash Mount Adapter for Nikonos SB-104 (AQFMANSB104):**  
Used to attach a Nikonos SB-104 to an Aquatica TLC lower arm section.....**33.50**

**Aquatica Flash Mount Adapter for Nikonos SB-105 (AQFMANSB102):**  
Used to attach an SB-105 to Aquatica TLC arm system..... **37.95**

**Aquatica Ball Head Flash Mount Adapter for Nikonos SB-105 (AQFMABNSB102):**  
Attaches a Nikon SB105 to an Aquatica TLC arm system.....**44.95**

**UNDERWATER**

**199**

## VIEWFINDERS

**DF-10 Non-UW Viewfinder (NIDF10):** A non underwater viewfinder is used on a Nikonos camera when using the 80mm lens on land. Setting the distance on the viewfinder will compensate for parallax.....**IMP. 89.95 /USA 99.95**

**DF-11 UW Viewfinder (NIDF11):** The DF-11 underwater viewfinder is used on a Nikonos camera when using the 15mm wide angle lens.....**IMP. 279.95 /USA 299.95**

**DF-12 UW Viewfinder (NIDF12):**  
The DF-12 underwater viewfinder is used on a Nikonos camera when using the 20mm f/2.8 UW and 28mm f/3.5 UW wide angle lenses.....**IMP. 179.95 /USA 199.95**

**USA= Imported & Warrantied by Nikon USA**

**IMP. = Imported & Warrantied by B&H**

(not qualified for Nikon USA rebates and warranties)



**ORDER & INFO. (212) 502-6340 • FAX: (212) 239-7770 (800) 947-7008  
1-800-290-6750 • www.bhphotovideo.com**



# SEALIFE

## REEFMAS<sup>T</sup>ER CAMERAS

UNDERWATER

200



### SL515 Reefmaster RC (SERMRC)

Operational up to 164', all the SL515 requires are two AA batteries and regular 35mm film. It features a wide angle lens, big sports viewfinder, large shutter lever (for easy use with gloves), automatic winding and a multi-coated 35mm f/3.5 optical glass lens with auto-focusing. The special "coral flash" compensates for the blue effect on closer objects but leaves the aqua blue color of the water untouched.

The unbreakable rubber housing protects from bumps and drops and provides a non-slip grip beneath the surface. The compact 35mm inner camera can be removed for use on land .....129.95



### SL545 SportDiver II (SESD2)

The most affordable underwater camera rated to 100' depth. Made of unbreakable Lexan, it features easy to use, one-button operation, and a large top-mounted sports finder. Compact and lightweight, it can be used while diving, snorkeling or for watersports. The inner camera has a built-in flash, slides out of the deep dive shell for land use, and fits into a shirt pocket.

Opening and closing of the Sealife Camera is easy and safe. All parts are replaceable, interchangeable, and upgradeable .....99.00

## REEFMAS<sup>T</sup>ER CAMERA KITS

### SL511 Reefmaster RC Underwater Camera Kit (SERMMK)

Developed by divers for divers, this kit features the ReefMaster RC camera which takes beautiful underwater and land pictures. It has a one step "Push Here" shutter lever for easy operation, an unbreakable rubber housing that locks out water and provides a non-slip grip beneath the water. A built-in a color corrected "coral flash" compensates for the blue effect on closer objects but leaves the aqua color of the seascape untouched. Operational up to 164', the ReefMaster RC camera requires are two AA batteries and regular 35mm film. The kit includes a water-tight carrying case, "Moisture Muncher" anti-fog desiccant, "Great Pictures Made Easy" booklet, a Macro 3x Close-up Lens and Underwater Filter which fits easily onto the camera's lens for close-up photos within 2 to 4' underwater. The lens is multi-coated to reduce excessive intensity and will improve pictures in low visibility water without the use of an additional strobe. The water-tight, shockproof case carry case includes a foam insert for accessories .....189.95



### SL560 Pro Dive Camera Kit (SERMP)

The SL560 Kit includes everything a diver needs to document underwater adventures. Operational up to 164', the 35mm Reefmaster RC camera features a wide angle lens, big sports viewfinder, large shutter lever, automatic winding and a color correcting flash. The kit includes a large External Flash unit for brighter pictures with more vivid colors, a Macro 3x Close-up Lens and Underwater Filter, a Care Kit, a deluxe carrying case, and a "Great Pictures Made Easy" booklet. The lens slips onto the camera for close-up photos within 2 to 4' underwater and 10" on land. The multi-coated lens enhances red and yellow color and reduces excessive blue color while providing exceptional clarity. The lens coating also reduces the possible over exposure of the ReefMaster cameras' built-in flash at close distances. The External Flash unit is positioned 12" from the camera's lens, and a deflector covers the camera's built-in flash, to reduce annoying backscatter.....339.95



## REEFMAS<sup>T</sup>ER ACCESSORIES

### SL960 External Underwater Flash (SESL960)

An easy-to-use underwater strobe light that enhances picture quality and brings out the natural color of the underwater world. It has a distance range from 2 to 8', and a rubberized flexible arm for easy aiming and a sure grip. Mounts easily to all SeaLife cameras...179.95



### Macro Set (SEMCRM)

This set includes a 16x and 8x macro lens and the macro "wand". The wand is an extendable guide to keep the correct distance from the camera to the object. The lenses easily snap on and off, and are changeable underwater.....89.95

### Macro 3X Close-Up Lens and UW Filter (SEM3XRM)

The lens weighs only 2 ounces and slips onto the camera for close-up photos within 2 to 4' underwater and 10" on land. It enhances red and yellow colors and reduces excessive blue in the photographs. ....34.95



**ONE HOUR FREE PARKING**  
AT 349 W. 34th STREET (with purchase of \$100 or more)



# SEA & SEA

## MX-5II



UNDERWATER

201

### All Weather Camera

A stylish ready-to-shoot camera for the casual shooter, the MX-5II is a compact amphibious camera engineered to make taking pictures fun and easy. It's rugged, reliable and built for the rigors of outdoor life. Take it diving, snowboarding, snorkeling and rafting. It has a built-in focus-free 28mm optical lens that captures sharp pictures both on land and underwater. It's hassle-free with auto film load, advance and rewind plus a built-in flash that fires automatically when extra light is needed for a good exposure. Ultra-light and ultra easy to use, add the optional accessory close-up lens and strobe and you have a versatile system that takes great snapshots wherever your adventurous spirit takes you.

#### FEATURES

- ◆ Taking pictures is as easy as 1-2-3. You don't have to set aperture, distance or shutter speed. Built-in "smart" flash fires when you need more light for a proper exposure, won't when you don't.
- ◆ Sportsfinder helps properly frame your subject. Doubles as a lens protector when folded down for storage.
- ◆ Back door is O-ring sealed, protecting battery compartment and film chamber.
- ◆ Strobe ready light is located next to the viewfinder, visible even while composing your next shot.
- ◆ Power On/Off switch also functions as a lock for the Sportsfinder when not in use.
- ◆ Wide-angle 28mm f/9 glass lens captures sharp underwater images. Exterior mount accepts the optional close-up lens.
- ◆ The LCD panel displays low battery warning, frame counter, film load confirmation, and flash indicator.



#### YS-20A Automatic Strobe (SEYS20A)

Designed exclusively for use with the MX-5II, the YS-20A strobe is lightweight, cordless and fully automatic. Connector shoe mounts the strobe to the camera without cords or cables—no chance of leakage. State-of-the-art infra-red optical triggering synchronizes the strobe with the camera shutter. Built-in sensor controls strobe output. The YS-20A will deliver the right light for crisp pictures with brilliant color. Included deflector pivots into position over the built-in flash. Uses 2 AA alkaline (150 flashes) or nicad (75 flashes) batteries with a recycle time of 6 seconds. It measures 3.9 x 3.3 x 6.3" (LxWxH) and weighs 0.75 lbs. (land, excluding batteries). Guide

number is 40 (on land) and depth rating is 150' .....215.00

#### Close-Up Lens for MX-5II (SECULMX5)

The Close-up Lens screws onto the front of the built-in lens and instantly reduces your minimum focusing subject-to-camera limit from 27" to 14". Now you can take full-frame pictures of cuttlefish, anemones, eels, and other small critters. Built-in diffuser minimizes backscatter. Parallax correction guide helps frame your picture perfectly. It can be attached or detached underwater, so you have the freedom of using both close-up and wide angle lenses on the same dive. Focusing distance is 20", depth rating is 150' .....44.95



#### MX-5 II Camera (SEM52BL)

With two AA batteries, O-ring set, case and hand strap. Blue color .....164.95

#### MX-5 II Camera (SEM52SYK)

Same as above in Yellow color .....164.95

#### MX-5 II Camera Kit (SEM52SBLK)

Includes a YS 20A Flash, two 1.5-volt "AA" alkaline batteries, O-ring set, case, hand strap and a 1-Year warranty. Blue color .....389.00

#### MX-5 II Camera Kit (SEM52SYK)

Same as above in Yellow color .....389.00

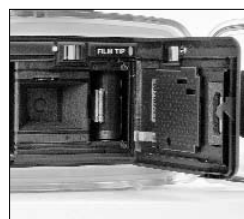

Back door is O-ring sealed, protecting battery compartment and film chamber.



Power ON/OFF switch also functions as a lock for the Sportsfinder when not in use.

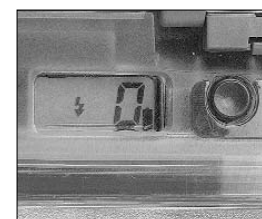

The LCD panel displays low battery warning, frame counter, film load confirmation, and flash indicator

ORDER & INFO. (212) 502-6340 • FAX: (212) 239-7770 (800) 947-7008  
1-800-290-6750 • www.bhphotovideo.com



# SEA & SEA

## MOTOR MARINE III

UNDERWATER

202

The new generation of Motor Marine is more rugged and offers more controls than ever before. This sophisticated amphibious camera has a built-in 20mm lens. It is designed to meet the needs of the amateur and experienced underwater photographers. With features like two point focus for fast reliable focusing and a target light for accurate framing, the Motor Marine III is a perfect choice for the beginning photographer.

Advanced features like strobe bracketing control and push-button shutter speed control provide creative freedom for the experienced photographer. All the controls of the Motor Marine III are on the top or back of the camera making them easier to read and operate.

The size and ease of use makes this camera ideal for activities that call for ultimate protection from the elements.



- ◆ LCD illumination is available for use in dark water or during night diving. It turns on for 10 seconds when the shutter release button is half-pressed and turns off when the button is fully pressed.
- ◆ By turning the Strobe Bracketing Dial (-1, -2/3, -1/3, 0, +1/3, +2/3, +1), you can manually adjust the value of EV compensation
- ◆ A target light turns on for 5 seconds when the shutter release button is half-pressed and automatically turns off when the button is fully pressed. The target light can be disabled when not needed.
- ◆ Ergonomically designed aperture dial permits operation while holding the camera. Six aperture levels (F3.8, F5.6, F8, F11, F16 and F22) are selectable.
- ◆ 2-point focusing allows you to choose either infinity or 0.6m (close) focusing. Depth of field (f5.6) at point (infinity) "∞" is 0.7m~∞. Depth of field (f5.6) at point (close) 0.6m is 0.4m~1m.
- ◆ Industry-standard 5-pin N-type strobe connector accepts most of the Sea & Sea strobe models. Dual-strobe photography is possible with an optional adapter.
- ◆ Pressing the Shutter Speed/AE Button for 2 seconds automatically turns on the Aperture Priority mode. If your choice of aperture is beyond the range of the film, the camera will give a warning and an aperture correction can be made up or down as needed.
- ◆ The camera automatically shuts off power when not used for 30-seconds after being turned on. Power can be turned on again by half-pressing the shutter release or turning the power switch off and on.

**Motor Marine III (SEMM3) .....\$899.00**

### LENSES FOR THE MOTOR MARINE III

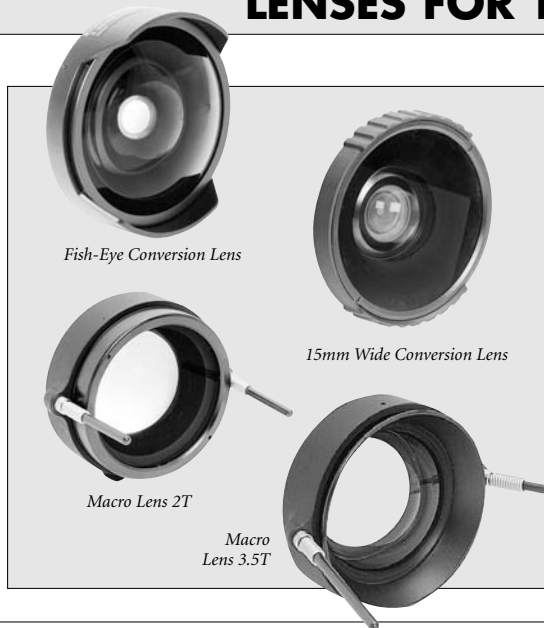

**Fish-Eye Conversion Lens (SEFLMM3)**  
This fish-eye lens has a 12.5mm focal distance and a focal distance magnification of 0.6x. It has a depth rating of 600', and a simple bayonet mount which is exchangeable under water. The minimum focusing distance is 15cm (at f22). It has a 150° underwater coverage angle with peripheral distortion correction .....**989.95**

**15mm Wide Conversion Lens (SE15MM3)**  
Featuring a simple bayonet mounting that makes it changeable in water, this lens has a minimum focusing distance of 8.7" (at f22), and a 101° underwater coverage angle with peripheral distortion correction.....**374.95**

**Macro Lens 2T (SEML2TMM3)**  
An underwater macro lens with a picture area of 74 x 50mm. Framer bars conveniently detach for easy transportation. Simple bayonet mounting, changeable in the water .....**233.95**

**Macro Lens 3.5T (SEML3.5TMM3)**  
Same as above with a picture area of 130 x 88mm .....**189.95**



# SEA & SEA

## MOTOR MARINE III

UNDERWATER

203

**Multi Viewfinder for MMIII (SEVFMM3)**  
Designed for MMIII, this viewfinder is required when you use a wide conversion lens. The 15mm/20mm scale and center position are clearly visible through a diving mask. Coverage ratio is 85%. Dimensions are 2.5 x 2.3 x 2.4", and it weighs 4.4 oz. on land .....**208.95**



**Fish-Eye Viewfinder (SEFWMM3)**  
Constructed from corrosion-resistant aluminum, this viewfinder has a coverage ratio of 85% and a depth rating of 200'. Dimensions are 3.1 x 2.7 x 3.5". It weighs 14.8 oz. on land, 7.9 oz. underwater .....**194.95**



**MB-60 Camera Case**  
This O-Ring sealed hard shell case together with the custom fitted foam protect and organize the Motor Marine III and accessories securely. Outer dimensions are 20.7 x 15.8 x 8". It's inner dimensions are 18.2 x 13.5 x 7.2" .....**Call**



**Lens Caddy for MMIII (SELCMM3)**  
Attaches to the optional Sea Arm VI by means of a velcro strap, and can carry one conversion lens for Motor Marine III .....**62.95**

## MM III STROBES & ACCESSORIES

**YS-30 II TTL Duo (SEYS302)**  
A compact TTL strobe with over-pressure relief valve for safety. Small size makes it ideal in confined environments like caves or macro photography where the strobe must be close to the subject. Mounts on multi-strobe rings for multi-strobe photography .....**347.95**

**YS-60 TTL-N Strobe (SEYS60BN)**  
Mid-size strobe brings out natural colors underwater. Offers TTL exposure control and manual mode. Built-in prism diffuser delivers even coverage for wide angle, close-up and macro photography .....**469.95**

**YS-90 TTL Duo Strobe (SEYS90)**  
A powerful strobe with a 105° angle of coverage. It offers TTL exposure control and manual mode .....**418.50**

**YS-120TTL Duo Strobe (SEYS120G)**  
Incorporates duo circuitry, 105° angle of coverage and a short recycle time. Compact size makes it perfect for travel .....**679.95**

**YS-350TTL Pro Strobe (SEYS350BN)**  
Professional quality underwater flash. Offers TTL exposure control and manual mode. It has a target light in the center of the circular flash tube which makes it easy to aim the light .....**999.95**

**Dual 5-Pin Sync Cord N (SESCDNQ)**  
Used to connect two strobes with the MMIII. Will not work with the YS-60 .....**154.50**

**5-Pin Sync Cord N (SESCNYS120)**  
Used to connect one strobe to the MMIII. Will not work with the YS-60 .....**93.50**

**Sea Arm VI Set (SESA6S)**  
Constructed of fiberglass-reinforced resin, the Sea Arm VI is a lightweight, yet strong arm. With the included components, you can create a custom arm setup for your lighting needs. It is suitable for all strobes .....**187.95**



|                            | YS-30 II TTL     | YS-60 TTL-N      | YS-90 TTL DUO                            | YS-120 TTL DUO | YS-350TTL               |
|----------------------------|------------------|------------------|--|----------------|-------------------------|
| Guide Number               | 20               | 22               | 22                                       | 22             | 32                      |
| Beam Angle                 | 80° x 55°        | 105° x 95°       | 105° x 95°                               | 105° x 105°    | 105° x 105°             |
| Flashes/Ni-MH battery      | 350              | 260              | 260                                      | 320            | 120                     |
| Recycle Time/Ni-MH battery | 2 seconds        | 3 seconds        | 3 seconds                                | 2 seconds      | 4 seconds               |
| Exposure Control           | FULL             | FULL, 1/2        | FULL, 1/2                                | FULL, 1/2      | FULL, 1/2, 1/4          |
| Color Temperature          | 5900° K          | 5400° K          | 5400° K                                  | 5100° K        | 5500° K                 |
| Depth Rating               | 200'             | 200'             | 200'                                     | 200'           | 200'                    |
| Flash Modes                | TTL/Manual       | TTL/Manual       | TTL, Auto 1 (Normal), Auto 2 (Pre-flash) | TTL/Manual     | TTL/Manual              |
| Power Source               | 2 AA batteries   | 4 AA batteries   | 4 AA batteries                           | 8 AA batteries | Exclusive Ni-Cd battery |
| Dimensions                 | 3.8 x 2.8 x 5.2" | 4.4 x 3.5 x 6.4" | 3.5 x 4.5 x 6.9"                         | 4 x 4 x 7.3"   | 5.9 x 5.7 x 7.6"        |
| Weight, land               | 1.1 lbs.         | 1.7 lbs.         | 1.6 lbs.                                 | 2.9 lbs.       | 4.4 lbs.                |

ORDER & INFO. (212) 502-6340 • FAX: (212) 239-7770 (800) 947-7008  
**1-800-290-6750 • www.bhphotovideo.com**



# IKELITE

## SLR-AF • SLR-MD

UNDERWATER

204

### *Underwater Housings for SLR Cameras*

*Ikelite's SLR cases have evolved into a classic providing dependable performance for over 25 years. They are probably the safest enclosure money can buy, and provide optical capabilities equal to anything. An assortment of interchangeable lens ports allow use of most macro, wide angle, and zoom lenses. They are also a part of a full system of TTL strobes, mounting systems, and accessories. The Ikelite SLR-AF and SLR-MD housings are "Clearly Superior" and allow visual assurance that the system is safe with a clear view of the camera information and control functions. The housings are injection molded of clear polycarbonate for its superior strength and corrosion-free properties, and operate safely to 200' working depth.*

*The housings are sized and weighted for near neutral buoyancy and superb handling underwater. Camera installation is quick and simple. The dependable controls are conveniently placed at your fingertips, and kept water tight with Ikelite pioneered Quad-Ring seal glands proven to be the most reliable method for sealing controls.*

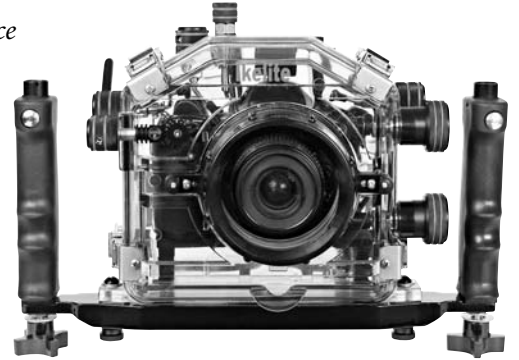

#### FEATURES

##### **Easy-to-Use**

- ◆ Ikelite housings are a joy to use. Their dependable, easy-to-operate controls are conveniently placed at your fingertips.
- ◆ Camera installation is quick and easy.
- ◆ Housings are sized and weighted for near neutral buoyancy offering stability and superb handling underwater.
- ◆ Ikelite housings operate safely to 200' and have proven to be the safest enclosures money can buy.

##### **Easy-To-Use Controls**

- ◆ Dependable, easy-to-operate controls are conveniently placed at your fingertips and kept water tight with Quad-Ring seal glands.
- ◆ Ikelite pioneered the quad-ring seal gland and it has proven to be the most reliable method for sealing camera controls in underwater housings.
- ◆ Ikelite's mechanical controls offer several advantages over electronic controls—the leading one being dependability.
- ◆ Thousands of Ikelite controls are in use with a performance record that approaches perfection. Mechanical controls allow the housing to feature more control functions resulting in a wider range of creative possibilities.

##### **Instant Visual Inspection**

- ◆ Ikelite housings are unique in that they allow visual inspection of camera, control functions, and all sealing surfaces - offering visual insurance your system is safe.
- ◆ Housings are injection molded polycarbonate for exceptionally strong and corrosion-resistant performance.

##### **SLR-AF Housing**

- Utilized for most SLR-AF cameras
- ◆ Compact-sized housing features clear polycarbonate body with black contoured back
- ◆ Measures 11 x 5.5 x 8" (LxWxH), the removable aluminum tray 14.5".
- ◆ Weighs 7.8 lbs. for near neutral buoyancy underwater

##### **SLR-MD Housing**

- Required for some larger SLR cameras
- ◆ MD housing is molded of clear polycarbonate
- ◆ Measures 10.5 x 6 x 8" (LxWxH), the removable aluminum tray 14.
- ◆ Weighs 10 lbs. for near neutral buoyancy underwater

##### **Included with the Housings:**

###### **Super-Eye Magnifier:**

Secures to the camera eyepiece and offers enhanced viewing while wearing a diving mask.

###### **Aluminum Tray:**

The removable aluminum tray features two mounts for Ikelite strobe arms

###### **Release Handles:**

Rubber hand grips features Ikelite's quick-release system for easy mounting and removal of accessories with the push of button.

###### **TTL Strobe Connection:**

External Ikelite TTL connector and internal TTL hot-shoe for the camera.

###### **Interchangeable Port System:**

Easily interchangeable ports accommodate most lenses. (No ports are included)



For Any Inquiries Regarding Your Order, Call Our Customer Service:  
(800) 221-5743 • (212) 239-7765 • FAX: (800) 947-2215 • (212) 239-7549

# IKELITE

## DOMES PORTS

The Ikelite dome is injection molded specifically for underwater photography, and represents the finest optics in the industry. Molded by one of the world's leading optical lens manufacturers, the dome corrects for water refraction to maintain the same coverage angle underwater. The dome functions as an optical lens underwater to create an image of the subject that appears much closer than the actual subject. The camera lens focuses on this apparent image of the subject. Recommended for wide angle lenses from 17mm to 28mm, and short zoom lenses. Zoom lenses require a +4 diopter close-up lens. Wide angle lenses will focus at 12" and do not require the addition of any close-up lens when used in a dome port.

(Note: Maximum lens diameter is limited to 3.3". The diameter for attachment of zoom or focus clamps is limited to 2.8". Lens length is measured as the maximum extended length from attachment point on the camera body. Only zoom lenses with rotating barrel control for zoom can be used. Push-pull zoom control can not be operated. Manual focus zoom lenses are not recommended.)



UNDERWATER

205

### Dome Port

- Lens length less than 3" (IK5503) .....**139.95**
- Lens length less than 4" (IK5503.50) .....**139.95**
- Lens length less than 4.5" (IK5503.55) .....**139.95**
- Lens length less than 5" (IK5503.80) .....**139.95**
- Lens length less than 6" (IK5503.85) .....**124.95**
- For Nikon 20mm f/2.8D lens (IK5503.20) .....**157.95**
- For Nikon 28-105mm f/3.5-4.5D lens (IK5503.81) .....**159.95**



### Flat Ports

Due to refraction, flat ports reduce the angle-of-coverage of a lens and at the same time enlarge the image. This makes the flat port ideal when using standard, macro and telephoto lenses to shoot small objects.

- |  |  |
|--|--|
| Lens length less than 2.5" (IK5501) ..... <b>84.95</b>     | Lens length less than 5.1" (IK5505.45) ..... <b>106.50</b> |
| Lens length less than 3.5" (IK5502) ..... <b>84.95</b>     | Lens length less than 5.5" (IK5505.5) ..... <b>106.50</b>  |
| Lens length less than 4.1" (IK5502.41) ..... <b>106.50</b> | Lens length less than 6.1" (IK5505.58) ..... <b>106.50</b> |
| Lens length less than 4.5" (IK5505) ..... <b>106.50</b>    |  |

### Flat Ports with Focus

For long lenses whose focus collar extends beyond the housing focus. Telephoto lenses longer than 135mm are not recommended.

- |   |   |
|---|---|
| Lens length less than 4.5" (IK5506) ..... <b>139.95</b>                         | Lens length less than 6.5" (IK5507) ..... <b>139.95</b> |
| Lens length less than 5.5" (IK5506.5) ..... <b>139.95</b>                       | Lens length less than 7.5" (IK5508) ..... <b>139.95</b> |
| For the Nikon 105mm Micro-Nikkor lens only (IK5508.05) ..... <b>148.95</b>      |   |
| For the Canon 100mm f2.8 EF USM Macro lens only (IK5508.45) ..... <b>148.95</b> |   |

### Super-Wide Dome Port

For lenses with a length less than 2.5", and 110 to 170° angle of coverage. This port does not allow use of a port shade, and is not compatible with the SLR-MD housing due to vignetting (IK5503.15) .....**139.95**



## AUTO 35 HOUSING WITH 35mm CAMERA

Compact, lightweight and trouble-free, the Auto 35 system is a full frame motor drive 35mm camera that delivers high quality photographs up to 125' underwater—safely and automatically. A well designed rugged system, not just a colorful "point and shoot" camera, the maintenance-free housing includes a special internal lens for optimum photos underwater as close as 2' from the housing. The Auto 35 also features a built-in hand grip with lanyard, accessory shoes, and sportsfinder for easy framing.

- ◆ Motorized film advance and rewind
- ◆ Built-in flash with automatic flash on/off
- ◆ DX coding
- ◆ Fixed-focus 28mm wide angle glass lens
- ◆ Accepts ISO 100, 200 & 400 film
- ◆ Removable point & shoot camera for land use

**Auto-35 Housing with 35mm Camera (IKA35)**  
Includes sports finder, wrist lanyard and a 1 year warranty .....**129.95**

**Auto-35 Package (IKA35K)**  
Includes Substrobe A35 with mounting tray, hand grip, adjustable arm and flash deflector, Macro Kit with framer, travel bag, sports finder and wrist lanyard ....**299.95**

ORDER & INFO. (212) 502-6340 • FAX: (212) 239-7770 (800) 947-7008  
**1-800-290-6750 • www.bhphotovideo.com**



# IKELITE

## SLR CASES FOR NIKON & CANON

UNDERWATER

206



All Ikelite housings for Nikon cameras include a hotshoe connection and housing bulkhead to allow addition of Ikelite Substrobes. All TTL Substrobes are compatible with the Canon TTL system, but don't indicate under exposure with the camera ready light. Compatible with the Nikon TTL system as well, providing even matrix metering with the 8008, N90 and N70, and rear curtain sync with the N90 and N70 series cameras. All housings provide aperture and zoom control, or focus control for manual lenses. Housings do not include port.

**TTL SLR-AF Case for Nikon N90, N90s, F90, F90s, F90x (IK6729.1)**  
The N90 has proven to be one of the most adaptable cameras to an underwater housing. The input dial (top right on body) is controlled by your thumb without removing your hand from the housing handle. A control knob can be turned to keep the focus lock button on the front of the camera body depressed. This is more convenient than operation of the MSC switch which also requires changing a focus switch on some lenses, and disengaging any manual focus gearing in a housing. The mode, drive, ISO, and flash-sync buttons on top left of camera body are operated by a single control which can be turned to keep any button depressed. Separate controls provide Ps, exposure compensation, and the LCD panel light. The auto focus/shutter release control also allows turning the camera on or off .....**639.95**

**TTL SLR-MD Case for Nikon F100 (IK6710)**  
Controls are provided for auto focus/shutter release, on/off, mode, +/- exposure compensation, front input dial, rear input dial, bracket flash, CSM, AF on, AF Lock, AE Lock and zoom and aperture .....**807.50**

**TTL SLR-AF Case for Nikon N80, F80 (IK6728.8)**  
This TTL SLR-AF Case has controls for on/off power switch, zoom, shutter release, exposure compensation +/- button, flash exposure compensation +/- button, main command (rear) dial, sub-command (front) dial, AE-L/AF-L button, auto exposure bracket button, flash sync button, and the exposure mode dial.....**629.95**

**TTL SLR-AF Case for Nikon N8008, N8008s, F801, F801s (IK6728.1)**  
Controls are provided for auto focus/shutter release, auto focus lock, command dial, on/off, exposure compensation, mode, ISO, drive, ME, matrix meter, zoom and aperture.....**639.95**

**TTL SLR-AF Case for Nikon N70, F70 (IK6727)**  
Controls for auto focus/shutter release, command dial, on/off, focus area, function button, vari-program, set button, zoom and aperture.....**639.95**

**TTL SLR-AF Case for Nikon N65, F65 (IK6726.5)**  
Controls for shutter release, rear command dial, aperture and exposure compensation buttons, auto focus, on/off, BKT, mode, and zoom .....**598.50**

**TTL SLR-AF Case for Nikon N60, N60-QD, F60 (IK6726.1)**  
Controls for shutter release, command dial, aperture and exposure compensation buttons, exposure mode dial, and zoom .....**639.95**

**TTL MD-size Housing for Nikon N6006, F601 (IK6726)**  
Controls for auto focus/shutter release, command dial, exposure compensation, on/off, shift button, meter button, zoom and aperture .....**639.95**

**TTL SLR-AF Case for Nikon N50, F50 (IK6725)**  
Controls for auto focus/shutter release, on/off, advanced/simple, mode buttons, shutter speed, exposure compensation, zoom and aperture.....**619.95**

### TTL SLR-AF Case for Canon Cameras

**TTL SLR-AF Case for EOS Elan 7, 7e, 30, 33 (IK6777.7):** Controls for auto focus/shutter release, custom function button, function button, main dial, quick dial, command dial, and zoom.....**629.95**

**TTL SLR-AF Case for EOS Elan II, IIe, 100II, 55, 50, 50e (IK6777):** Controls for auto focus/shutter release, focus point, custom function AE lock buttons, function button, main dial, quick dial, command dial, meter mode, and zoom .....**639.95**

**TTL SLR-AF Case for EOS Rebel G, Rebel G Date, X, XS, 500, 500N, and 500NQD (IK6773):** Controls for auto focus/shutter release, input dial, command dial, exposure compensation, manual aperture button, and zoom.....**639.95**

**TTL SLR-AF Case for EOS Rebel, 2, 2S, 1000, 1000F, 1000N, 1000FN (IK6772)**  
Controls for auto focus/shutter release, input dial, command dial, exposure compensation, manual aperture button, and zoom .....**639.95**



For Any Inquiries Regarding Your Order, Call Our Customer Service:  
(800) 221-5743 • (212) 239-7765 • FAX: (800) 947-2215 • (212) 239-7549

# IKELITE

## SUBSTROBES

UNDERWATER

207

The underwater environment presents unique lighting challenges. Only a portion of the sun's rays penetrate the water. As they lose intensity with depth, the colors lose vibrancy and blend together. After reds fade, followed by oranges and yellows, photographic images are left with a blue-green cast. Illuminate the colors in your subjects with an Ikelite Substrobe so you can perceive and record the full beauty and spectrum of marine life.

### Substrobe DS50



The DS-50 is compatible with all film cameras including the Nikonos. It features the best price, recycle time (3.5 seconds), and most flashes per set of batteries in its class. Offers both TTL and manual exposure. Operates TTL when connected with appropriate sync cord to applicable cameras or housing; or utilized with

Ikelite's wireless TTL Slave Sensor system.

The DS-50 provides ten power settings in half/stop increments when connected to the optional Manual Controller (see next page). This compact strobe provides 50 w/s of power with coverage for 28mm lenses. Add the included diffuser for wider coverage and softer lighting. Combine several to cover very wide angle lenses with minimal illumination of particles suspended in the water. Powered by 4 AA alkaline, NiMH or nicad batteries

**Substrobe DS50 (IK4043): Orange .....299.95**  
**Substrobe DS50 (IK4044): Gray .....335.95**

### Substrobe 50s (IK404.35)

The Substrobe 50s is a manual exposure, manual slave version of the DS50. Strobe specifications and basic features are the same, except the 50s fires only full power manual exposure triggered by a built-in slave sensor or via optional sync cord .....**Call**

### Substrobe 100a (IK4046.1)

The versatile Substrobe 100a is a powerful medium-sized strobe with an adjustable coverage from 80° to 95°. A turn of the knob provides optimum coverage for a full range of lenses from 15mm to macro. The adjustable coverage eliminates the need for a diffuser that would reduce the light output by one f-stop.



The special soft-lite reflector and 4800° Kelvin color temperature enhance reds and oranges, and provide exceptional flesh tones. Built-in modeling light helps in aiming the strobe while illuminating subject's colors.

The electronics are completely sealed from the battery compartment. The strobe provides approximately 160 flashes from four "D" cell alkaline batteries. Full power recycle time is less than four seconds. Optional nicad pack with industrial grade 5.0 AH matched cells and 6-hour charger is also available.....**409.95**

### Substrobe 200 (IK4062.1)



A high performance professional strobe that revolutionizes underwater photography. State-of-the-art electronics provide a blazing 200 w/s of power—recycling in an incredible 1.6 seconds. Mount the strobe on either side of the camera and the control panel and

ready light are always visible for quick confirmation and easy access. Both visual and audible ready signals convey flash readiness and confirm TTL operation. It offers four manual power modes. The Substrobe 200 delivers an even ultra-wide 100° beam, wider than the Nikonos 15mm lens, eliminating the need for a wide angle diffuser that would reduce output by one f-stop. Ikelite's special soft-lite reflector produces softer, warmer, more natural colors. The built-in aiming light is more than just a target light; it is powerful enough to use as a night diving light. Strobe electronics are sealed from the battery compartment, and the industrial grade nicad battery module is easily removed. No more guessing about when to recharge; an LED film gauge shows how many rolls of film can be exposed with the remaining battery power ...**729.95**

### Substrobe DS-125 (IK4065)

The Substrobe DS-125 features special electronic circuitry for use with digital cameras, but is completely compatible with all film cameras including Nikonos cameras. It combines high intensity 110 w/s output and wide 100° coverage



angle with diffuser. A special coated soft-lite reflector produces more natural colors with rich reds, oranges and warmer flesh tones. It features TTL auto exposure plus four manual power settings (full, 1/2, 1/4, and 1/8 power).

The strobe's digital electronics are pre-flash compatible when used with the optional DS Sensor or EV-Controller with digital cameras. Easily interchangeable nicad battery recycles in one second, while a fuel gauge references remaining battery power. Offers both visual and audible ready signals. A built-in modeling light/diving light assists in aiming and to illuminate your subjects colors. Equipped with Ikelite's unique Flip-Lock design to easily install and remove batteries. Spare nicad modules and 1.5-hour smart charger are optionally available.....**594.50**

**ORDER & INFO. (212) 502-6340 • FAX: (212) 239-7770 (800) 947-7008**  
**1-800-290-6750 • www.bhphotovideo.com**



# IKELITE

## SUBSTROBE ACCESSORIES

UNDERWATER

208

**EV Manual Exposure Controller (IK4100.6)**  
Provides 10 manual power settings in half-stop increments for the DS-50 and DS-125. It has a slave sensor allowing it to be triggered by another strobe; or attach any of the sync cords to the Controller bulkhead. The Controller attaches to the strobe and can be used with normal or pre-flash camera and strobe systems. A second strobe with a Manual Controller can be set to any desired power and will operate with the built-in slave sensor aimed at the subject or the primary strobe; or the Controller can be connected to a dual sync cord. A second strobe with the TTL Slave Sensor duplicates power levels it sees on the primary strobe.....127.50

**TTL Digital Slave Sensor (IK4100.5)**  
A wireless TTL slave sensor, the DS Sensor provides wireless TTL slave operation within 1/10 of one f-stop precision. The sensor is turned on automatically by the strobe ready light. When attached to a DS series digital strobe, it can also be triggered by and used with any type of camera and strobe.....127.50

|                        | 50 / DS-50           | 100A         | DS-125 | 200           |
|------------------------|----------------------|--------------|--------|---------------|
| Coverage Angle         | 70°                  | 95°-80°      | n/a    | 100°          |
| <b>Guide # ISO 100</b> |                      |              |        |               |
| Surface (feet)         | 56'                  | 52-60'       | n/a    | 76'           |
| Underwater (feet)      | 28'                  | 28-30'       | n/a    | 38'           |
| <b>Firing Modes</b>    |                      |              |        |               |
| TTL                    | ✓                    | ✓            | n/a    | ✓             |
| Manual                 | ✓                    | ✓            | n/a    | ✓             |
| 1/2, 1/4, 1/8 Manual   | –                    | 1/2          | n/a    | 1/2, 1/4, 1/8 |
| Remote TTL Slave       | optional             | optional     | n/a    | optional      |
| Color Temperature      | 5700° K              | 4800°K       | n/a    | 4800°K        |
| <b>Power Source</b>    |                      |              |        |               |
| 4 "AA" Alkaline        | ✓                    | ✓            | n/a    | –             |
| Ni-Cad                 | not-included         | not-included | n/a    | 3             |
| Flashes (full power)   | 200                  | 160          | n/a    | 160           |
| Recycle Time           | 3.5 sec.             | 3.8 sec.     | n/a    | 7.6 sec.      |
| Audible Signal         |                      |              | n/a    | 3             |
| Modeling Light         | Optional Mini C-Lite | Built-in     | n/a    | Built-in      |

## CORDS

### Sync Cords for Ikelite TTL Housings

#### Ikelite Strobe:

Connects Ikelite TTL housing to Ikelite TTL Substrobe(s).

**Sync Cord (IK4103.51):** To connect single Ikelite TTL strobe.....94.95

**Sync Cord (IK1405.24):** Short 24" version of above .....63.95

**Sync Cord (IK4103.52):** To connect two Ikelite TTL strobes .....135.95

#### Nikonos Strobe:

Connects most Ikelite TTL housings to SB-102, SB-103, SB-104 and SB-105 strobe(s).

**TTL Sync Cord (IK4115.31):** Connects one Ikelite TTL SLR housing to one Nikonos strobe.....84.95

**TTL Dual Sync Cord (IK4115.32):** Connects one Ikelite TTL SLR housing to two Nikonos strobes .....135.95

**TTL Dual Sync Cord (IK4115.35):** Connects one Ikelite TTL SLR housing to one Nikonos strobe and one Ikelite TTL Substrobe....135.95

#### Inon and Sea & Sea Strobes:

These cords connect sync circuit only, providing only manual strobe operation. TTL is not possible with these strobes and cords.

**Sync Cord (IK4118.1):** To connect one strobe to Ikelite housing .....84.95

**Sync Cord (IK4118.2):** To connect two strobes to Ikelite housing..135.95

### Cords for Cameras and Housings with Nikonos Socket

These cords connect to Nikonos IV, V, RS cameras and Aquatica, Nexus, Subal housings featuring the female Nikonos socket.

#### Ikelite Strobe:

Connects Nikonos system to Ikelite TTL Substrobe(s)

**TTL Sync Cord (IK4104.6):** Connects single Ikelite strobe .....79.95

**TTL Sync Cord (IK4104.51):** Short 18" version of above .....71.95

**TTL Dual Sync Cord (IK4104.62):** Connects two Ikelite strobes .....135.95

#### Nikonos Strobe:

Connects Nikonos system to Nikonos SB-102, SB-103, SB-104 and SB-105 strobe(s)

**TTL Sync Cord (IK4115.1):** Connects single Nikonos SB-strobe.....84.95

**TTL Dual Sync Cord (IK4115.2):** Connects 2 Nikonos SB-strobes....135.95

#### Dual Ikelite and Nikonos Strobe:

Connect Nikonos system to Ikelite TTL Substrobe and Nikonos SB-102, SB-103, SB-104 and SB-105 strobe

**TTL Dual Sync Cord (IK4115.36):** Connects one Ikelite and one Nikonos TTL strobe .....135.95



For Any Inquiries Regarding Your Order, Call Our Customer Service:  
(800) 221-5743 • (212) 239-7765 • FAX: (800) 947-2215 • (212) 239-7549



# IKELITE

## CABLES & CORDS

**Non-TTL Sync Cord (IK4104):** Connects Ikelite non-TTL housing to single Ikelite Substrobe .....**79.95**

**Non-TTL T-Connector (IK4109):** Connects an Ikelite non-TTL housing to two Ikelite non-TTL sync cords .....**63.95**

**Non-TTL T-Connector (IK4112):** Connect an Ikelite non-TTL housing to two Nikonos sync cords .....**CALL**

**TTL Dual Sync Cord (IK4115.36):** Connects a Nikonos camera to one Ikelite substrobe and one Nikonos strobe.....**135.95**

**TTL Dual Sync Cord (IK4104.25)**  
Connects an Ikelite non-TTL housing and a Nikonos camera to a Ikelite a TTL substrobe.....**135.95**

**TTL Dual Sync Cord (IK4103.25)**  
Connects an Ikelite TTL housing and a Nikonos camera to one TTL Substrobe.....**109.00**

**PC Sync Cord (IK4104.1)**  
Connect PC plug (surface use) to an Ikelite Substrobe .....**67.50**

### Extension Cords

Extend the original cord length. Extension cords install between any Ikelite SubStrobe, "T" Connector, Remote Sensor or Ikelite sync cord; and between Ikelite TTL SLR housing and TTL sync cord.

**Extension Cord (IK4102.03):** 3' long .....**53.95**

**Extension Cord (IK4102.15):** 15' long .....**53.95**

### Connector Protector

Protects Ikelite TTL and Nikonos male connectors. Provided with appropriate cords.

**Protector (IK0301):** Accepts two Ikelite connectors .....**6.95**

**Protector (IK0301.1):** Accepts one Ikelite and one Nikonos connector .....**6.95**

**Protector (IK0301.12):** Accepts one Ikelite connector.....**Call**

## SA-100 Arms & Components

The DS50 and DS125 Substrobes don't require the tremendous holding power of Ikelite's larger 1.25" diameter ball arms. The SA-100 1" diameter ball system operates very nicely underwater and interchanges with ULCS and TLC arm components.

### SA-100R Arm (IK4086.61)

Mounts to Ikelite Release Handle and allows easy strobe placement from macro to wide angle without changing the aim of the sensor. The complete system removes with push of the handle button. Arms extended length is 14". For the DS50 and DS125 .....**139.95**

### SA-100T Arm (IK4086.14)

The SA-100T Arm mounts to Ikelite handles and trays with wing-nuts. It incorporates a 4" and a 6" arm for optimal flexibility for all types of photography from macro to wide angle. Arms extended length is 16". Exclusively for the DS50 and DS125 .....**179.95**

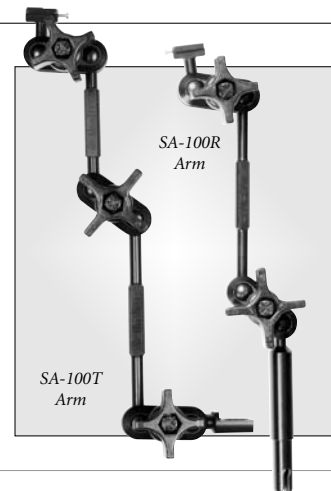

### Release Handle Extender (IK9571.3)

1" Ball with extended length stem snaps into Release Handle. Allows attaching a Slave Sensor or Manual Controller so its position does not change when aiming the strobe.....**24.95**

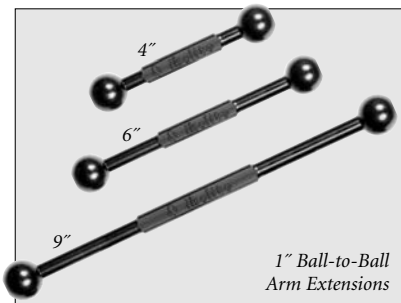

**1" Ball-to-Ball Arm Extension (IK0466.42)**  
4" arm .....**26.95**

**1" Ball-to-Ball Arm Extension (IK0466.62)**  
6" arm .....**26.95**

**1" Ball-to-Ball Arm Extension (IK0466.92)**  
9" arm .....**35.95**

**1" Ball Clamp (IK9571.2)**  
Clamps two 1" balls together.....**37.95**

**1" Ball Clamp with Stud (IK09571.23)**  
Clamp is available with Mounting Stud for attaching TTL Sensor or Manual Controller if not using Release Handle Extended .....**41.50**

**1" Ball with Mount (IK9577.71)**  
For camera tray or handle .....**19.95**

**1" Ball with DS50 and DS125 Mount (IK9571.4)**  
Mounts to the underside of strobe.....**24.95**

**1" Ball with DS100a and SS200 Mount (IK9577.43)**  
Mounts to the underside of strobe.....**24.95**

**Ball-to-Ball Arm Adapter (IK0466.51)**  
Arm is available with 1" ball on one end and 1.25" diameter ball on the other end. This 6" arm allows combining different systems .....**27.95**

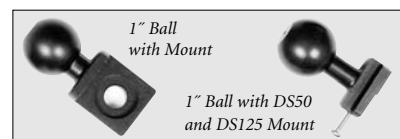

# IKELITE

## SA-125 ARMS & COMPONENTS

UNDERWATER

210

### SA-125 Quick Grip Arm

Articulating ball-socket arm with quick release handle. Removable at the push of a button, the contoured rubber grip offers easy one hand control in hand holding the strobe. Ikelite design provides vastly greater holding power than other systems. Adaptable to other brand camera housings with optional Universal Mount or TLC Mount.

**Quick Grip I** (IK4082): 15" quick release handle, ball clamp, and tray mount especially suitable for wide angle photography with heavy strobes .....101.95

**Quick Grip II** (IK4083): 9" quick release handle, 6" arm extension, two ball clamps, and tray mount .....151.95

### SA-125 Macro Grip Arm

Articulating ball-socket macro arm. The Macro Grip Arm combines two short 4" arm sections with a series of three ball clamps for the ultimate in maneuverability. Features special ball mount at the base of the strobe to position it wherever desired for creative macro photography.

**Macro Grip Arm** (IK4085.14): For Substrobe 50, DS50, DS125.....175.95

**Macro Grip Arm** (IK4085.24): For Substrobe Ai, 100A, 200 .....179.95



## SA-125 Ball Arm Components

Featuring interchangeable 1.25" ball components to build or add to the Ikelite ball arm system.

### Quick Release Handle

The Quick Grip handle allows easy removal by pushing a button with the heel of your hand. Attaching is just as easy, and the aiming adjustment will not have been changed. The comfortable rubber handle has been molded around the tubing. The handle allows you to "feel" strobe aim when hand holding the strobe. Two mounting types are available:

**QR Handle with Strobe Mount:** Allows direct attachment of all Ikelite strobes, and provides vertical aiming of the strobe. Rotational aiming is accomplished by the ball at the base of the handle. This style may be preferred so the strobe is aligned with the direction of the handle.

**QR Handle with 1.25" Ball:** Allows use of the optional ball mounts at the strobe head with Ball Clamp F. This style may add aiming versatility for macro photography.

#### QR Handle with Strobe Mount

7" QR Handle (IK9578.07) .....37.95  
 9" QR Handle (IK9578.09) .....37.95  
 15" QR Handle (IK9578.15) .....37.95

#### QR Handle with 1.25" Ball

7" QR Handle (IK9581.07) .....37.95  
 9" QR Handle (IK9581.09) .....37.95  
 15" QR Handle (IK9581.15) .....37.95

### Handle Mount Ball

Accommodates both the QR with a strobe mount or a 1.25" ball. It is also available with 1" diameter ball.

1.25" Handle Ball with Stem (IK9577.3): Snaps into release handle .....19.95  
 1.25" Handle Ball with Stem (IK9577.33): Same as above with an extended stem .....28.50  
 1" Handle Ball with Stem (IK9571.3): Snaps into release handle .....24.95

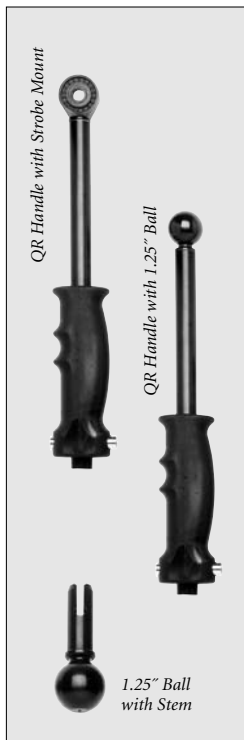

For Any Inquiries Regarding Your Order, Call Our Customer Service:  
 (800) 221-5743 • (212) 239-7765 • FAX: (800) 947-2215 • (212) 239-7549

# IKELITE

## SA-125 COMPONENTS

### Strobe Arm Extensions

- 4" Arm Extension (IK9579.04).....24.95
- 6" Arm Extension (IK9579.06).....24.95
- 12" Arm Extension (IK9579.12).....24.95

### Ball-to-Ball Arm Extension

- 4" Arm Extension (IK9580.04).....28.50
- 6" Arm Extension (IK9580.06).....28.50
- 12" Arm Extension (IK9580.12).....28.50

### Ball Clamps

- Ball Clamp** (IK9577.2)  
Clamps two 1.25" balls together.....37.95
- Ball Clamp with Stud** (IK9577.23)  
Clamps two 1.25" balls together. It has a mounting stud for [S] Lite Mount, TTL Sensors or a Manual Controller.....47.50
- Ball Clamp with Stud** (IK9571.23)  
Clamps two 1" balls together. It has a mounting stud for [S] Lite Mount, TTL Sensors or a Manual Controller.....47.50

### Ball with Ikelite Tray Mount

- 1.25" Ball Mount** (IK9577.1)  
For Ikelite camera tray or handle .....19.95
- 1" Ball Mount** (IK9577.71)  
For TLC and Ultralite clamps .....19.95

### Ball with Universal Mount

- 1.25" Ball with Universal Shoe Mount** (IK9577.5): Attaches to a "T" shaped shoe found on many other housings.....19.95

### TLC Tray Mount

- 1.25" Ball with Dove-Tail Mount for TLC Tray** (9577.7) .....24.95

### Nikonos Shoe Mount

- 1.25" Ball with Nikonos Foot Mount for Nikonos IV/V Cameras** (IK9577.6) .....28.50

### Substrobe 50, DS50, DS125 Mount

- 1.25" Ball with Substrobe Mount** (IK9577.41): Mounts to the underside of the substrobes.....19.95

### Substrobe Ai, 100A, 200 Mount

- 1.25" Ball for Ikelite Substrobes** (IK9577.42)  
Mounts to underside of substrobes.....24.95
- 1" Ball for Ikelite Substrobes** (IK9577.43)  
Also works with Aquatica TLC and the Ultralite arm system .....24.95

### Nikonos Mount

- 1.25" Ball for Nikonos Strobes** (IK9577.45)  
Attach a Nikonos SB103 or 105 strobe to an Ikelite 1.25" diameter arm system.....24.95

### Lite Bracket

- Lite Bracket for Mini-C Lite** (IK4073) Mounts the Mini C-Lite as an aiming light, with or without the Substrobe 50 .....4.95



### Tube Mount

- Lite Meter Clamp** (IK9575.2)  
Used to attach the Ikelite digital exposure meter to the 3/4" diameter tubing of the Ikelite arm system.....19.95

## Strobe Arm II & Arm Accessories



- Strobe Arm II** (IK4076)  
Double sectioned articulating arm system is especially convenient for macro photography. The 12" upper and 6" lower arms pivot, swivel, extend and retract in their respective flexible joints .....53.95
- Strobe Arm Is** (IK4075.1)  
Specifically configured for the new SLR Release Handle System. It attaches to the top of either handle or to either end of the Top Mount Assembly. The Strobe Arm Is is comprised of a Tube Mount (9575.1) and a 12" Tube Strobe Arm.....59.50
- Second Arm Section with Joint** (IK4076.2)  
Replacement for Strobe Arm Is.....22.50

- 6" Tube Strobe Arm** (IK9582.06) .....19.95
- 9" Tube Strobe Arm** (IK9582.09) .....19.95
- 15" Tube Strobe Arm** (IK9582.15) .....19.95
- 18" Tube Strobe Arm** (IK9582.18) .....CALL
- Arm Adapter N** (IK4072): Attaches Nikonos SB103 or 105 strobe head to an Ikelite arm .....CALL
- Mount Adapter N** (IK0301.85): Mount complete Nikonos SB103 or 105 strobe arm to Ikelite tray .....26.95
- Clamp Mount** (IK9580): Mounts on the tube of an SA-125 arm, or either Strobe Arm to secure a DS Sensor, EV-Controller or Remote TTL Slave Sensor.....24.95
- Meter Mount** (IK9575.2): Combined with the Clamp Mount, the Meter Mount will secure the Exposure Meter to the tube of SA-125 arms or either Strobe Arm ....19.95
- Tubular Mount with Stem** (IK9575.4): Mounts an Exposure Meter or SA-125 Arm on a Release handle.....28.50
- Strobe Arm Mount** (IK9575.1): Mounts the tube from the Strobe Arm II to an Ikelite Release Handle.....47.50
- Lite Clamp** (IK4074.1): Mounts on the tube of an SA-125 ARM, Strobe Arm II or Strobe Arm Is to secure the Mini-C Lite as a modeling or night diving light.....28.50
- Lite Mount** (IK4074): A light Mount and a Tray Mount that secures to Ikelite handles with wing nuts .....33.50

UNDERWATER

211

# EWA MARINE

## UNDERWATER HOUSINGS

UNDERWATER

212

### Ultimate Protection for 35mm Cameras



With an Ewa-Marine camera housing you can take just about any 35mm camera underwater, either manual or autofocus—often with zoom lens, flash and autofocus lens—to capture truly world class photos. Lightweight, yet very robust for long and dependable service life, the housings let you shoot at depths of 30, 60 or even 150' (depending on the model), plus allow you to take your camera into the most hostile environments (humidity, seawater, spray, sand, dust) without having to fear for the safety of your camera and lens. The special sheeting used for the housings is molded and welded by an elaborate process. They are fitted with a front port made of neutral, high quality optical glass. These and a number of other features (depending on the model) let you shoot pictures that will be the envy of your friends.

Ewa-Marine SLR cameras housings are flexible, allowing easy control of the camera, while an adapter system holds the camera's lens securely to the front optical glass port. "Finger ports" allows you to access your camera's most important controls, such as program modes, shutter release mechanism, and tele/wide buttons.

### FEATURES

- ◆ Unlike hard housings which are sealed with sensitive O-rings that require careful maintenance and can leak without warning, Ewa Marine's housings require no such rings and their waterproofness is virtually independent of depth.
- ◆ The housings are ultra-sonic welded, UV resistant and feature their own carry strap. All underwater housings are sealed via a triple stainless steel, non-corrosive screw closing rail.
- ◆ Perfect for snorkeling, shallow diving, sandy, dusty, humidity or foul weather conditions. The housings will give your camera the best possible protection while being fully operable.
- ◆ They have a pair of non-corrosive and sea-water resistant clamping rails which fit together for perfect sealing. They tighten by means of two or three screw knobs.
- ◆ EWA Marine flexible housing are extremely easy to maintain. There are no "O"-rings to maintain as found in hard housing that may contain as many as 12-18 rings (a hard housing is only as good as its "O"-ring seals). These rings must be constantly inspected, greased, and many times - replaced. EWA Marine housings only require a quick rinse in fresh water, towel dry, keep then away from sharp objects, and do not allow them to bake in the sun.
- ◆ Although they have a practical operating depth of 30', these flexible housing can be successfully taken to hundreds of feet with absolutely no damage to the housing. The depth limitation is due to the design of the actual camera. For example, water pressure exerted on a flexible housing causes the housing to compress, which affects various protruding camera controls such as a shutter button, on/off switch, or zoom button. Those designed with greater protruding controls will be even more adversely affected with "sticking" control buttons in less depths of water. Depth operation is dependent upon the construction of the camera and not the housing.
- ◆ Many of the housings weigh less than two pounds as compared to housings weighing in at 10-20 lbs. They also serve as durable protection in rain and snow conditions. Housings fold for easy storage in a camera bag.

#### Camera Dry Munchers (EWCD5)

No more lost photos — stop condensation before it starts. Reusable, the "Munchers" fit most Ewa housings perfectly. Built-in color indicators let you know at a glance their condition. (Pink for saturated, Blue for okay). They can be recharged up to 5 times. Set of 5 .....14.50



### 35mm Point & Shoot Camera Housings

|  |   |
|--|---|
| <p><b>U-AM Compact Camera Housing (EWUAM):</b> For cameras with fixed or short zoom lens. Fits lens diameters (less than 2"). The housing measures 3.5 x 6 x 2.75" (HxLxD) .....<b>84.95</b></p>         | <p><b>U-AMZ Compact Point &amp; Shoot Camera Housing (EWUAMZ):</b> For cameras with zoom lens up to 5" long, 2" wide. Measures 3.5 x 6 x 5" (HxLxD) .....<b>84.95</b></p> |
| <p><b>U-MM Mini Compact Camera Housing (EWUMM):</b> Large rectangular lens port fits a large variety of cameras as lens placement is not critical. Measures 3.5 x 5 x 3.3" (HxLxD) .....<b>89.95</b></p> |   |



For Any Inquiries Regarding Your Order, Call Our Customer Service:  
(800) 221-5743 • (212) 239-7765 • FAX: (800) 947-2215 • (212) 239-7549

# EWA MARINE

## UNDERWATER HOUSINGS

UNDERWATER

213

### Photo Camera Rain Capes

Sport capes are for popular digital and 35mm cameras, and offer complete protection against rain, snow, moisture and dust. (They are not for underwater use). Ideal for use on boats and on the beach. Most feature oversized optical glass ports for clear, brilliant photography.

#### C-AF Hurricane Photo Cape (EWC9)

Optical glass port 80mm with 49-62mm adapter ring included. Holds lens up 8" long .....**89.95**

#### C-AFX Hurricane Photo Cape (with flash) (EWCAFX)

Same as the C-AE, however its larger rectangular shape allows use with top mounted flash.....**153.95**

#### C-AF100 Hurricane Photo Cape (EWCAF100)

For SLR cameras with up to 8" lens with 77mm adapter.....**159.95**

#### C-500 Pro Hurricane Hood (EWC500)

Designed for use with most 500mm/600mm lenses. Velcro lens opening fits various diameters and lengths up to 16" long .....**159.95**



U-AXP

### Housings For Autofocus SLR Cameras

**UA (EWUA):** For SLR cameras with or without a built-in flash .....**249.95**

**U-AX (EWUAX):** For SLR cameras with a top mounted flash and long zoom lens.....**259.95**

**U-AXP (EWUAXP):** For SLR cameras with a top mounted flash .....**299.95**

#### U-AXP100 (EWUAXP100):

A special version of the U-AXP which allows the use of lenses with a 77mm or 82mm filter diameter and internal focus.....**369.95**

#### U-AZ (EWUAZ):

For SLR cameras with a long zoom lens....**259.95**

| Model    | Length    | Width | Height | Position of Viewfinder           | Front Port Diameter     | Weight    | Works to a Depth of |
|----------|-----------|-------|--------|----------------------------------|-------------------------|-----------|---------------------|
| UA       | 4¼" - 6¾" | 6¾"   | 5½"    | 2 <sup>5</sup> / <sub>16</sub> " | 72mm max. filter thread | .85 lbs.  | 60'                 |
| U-AX     | 4¼" - 6¾" | 6¾"   | 9½"    | 2 <sup>5</sup> / <sub>16</sub> " | 72mm max. filter thread | .95 lbs.  | 60'                 |
| U-AXP    | 4¼" - 6¾" | 7½"   | 10¾"   | 2 <sup>5</sup> / <sub>16</sub> " | 72mm max. filter thread | 1.5 lbs.  | 150'                |
| U-AXP100 | 4¼" - 6¾" | 7½"   | 10¾"   | 3¼"                              | 77/82mm filter thread   | 1.55 lbs. | 150'                |
| U-AZ     | 6¾" - 9"  | 6¾"   | 5½"    |                                  | 72mm max. filter thread | 0.9 lbs.  | 60'                 |

### Housings For Manual SLR Cameras

| Model | Length | Width | Height | Weight   | Works to Depth of |
|-------|--------|-------|--------|----------|-------------------|
| UF    | 6.2"   | 5"    | 4.3"   | 14.8 oz. | 33'               |
| U-FX  | 4.6"   | 8.6"  | 5.1"   | 14.8 oz. | 33'               |
| U-FXP | 8.8"   | 6"    | 4.7"   | 14.8 oz. | 33'               |
| U-FGM | 10"    | 9.8"  | 4.7"   | 14.8 oz. | 33'               |

**UF (EWUF):** For manual SLR cameras with a lens, with or without a motor drive.....**189.95**

**U-FX (EWUFX):** For manual SLR cameras with a lens and shoe-mounted flash .....**204.95**

**U-FXP (EWUFXP):** For manual SLR cameras with a lens and a 6" tall side-mounted flash .....**209.95**

**U-FGM (EWFGM):** For manual SLR cameras with a lens and a 9.8" tall side-mounted flash .....**234.95**

ORDER & INFO. (212) 502-6340 • FAX: (212) 239-7770 (800) 947-7008  
**1-800-290-6750 • www.bhphotovideo.com**









# The 35mm SLR Photo

SourceBook

## Section 3

### Flashes & Accessories

#### Flashes

|                             |         |              |         |
|-----------------------------|---------|--------------|---------|
| Achiever .....              | 216     | Metz .....   | 218-229 |
| Novoflex ....               | 230-233 | Sunpak ..... | 234-241 |
| Vivitar .....               | 242-244 |              |         |
| AC & DC Slave Strobes ..... | 245-247 |              |         |

#### Flash Accessories

|                                    |         |
|------------------------------------|---------|
| Light Bouncers and Softeners ..... | 248-253 |
| Camera/Flash Brackets .....        | 254-265 |

#### Battery Packs and Portable Strobe Lighting

|                          |         |
|--------------------------|---------|
| Dynalite .....           | 266     |
| Norman .....             | 267-269 |
| Lumedyne.....            | 270-279 |
| Quantum Instruments..... | 280-289 |

#### Slaves

|                          |         |
|--------------------------|---------|
| Quantum Instruments..... | 290-293 |
| Pocket Wizard.....       | 294-297 |
| Wein.....                | 298-301 |

#### Exposure Meters

|                               |         |               |         |
|-------------------------------|---------|---------------|---------|
| Gossen .....                  | 302-307 | Minolta ..... | 308-313 |
| Polaris .....                 | 313     | Sekonic ..... | 314-318 |
| SP/Spectra/Visatec/Wein ..... | 319     |               |         |

# ACHIEVER

## SHOE MOUNT FLASHES

### 115M

#### Compact Manual Shoe Mount Flash

- ◆ Guide no. 48 (ft. ISO100)
- ◆ Runs on 2 AA batteries
- ◆ Includes PC sync cord

AC115M .....17.95

### 115A

#### Compact Auto Shoe Mount Flash

- ◆ Automatic exposure range
- ◆ Manual exposure operation
- ◆ Guide no. 48 (ft. ISO100)
- ◆ Runs on 2 AA batteries
- ◆ Includes PC sync cord

AC115A .....21.95

### 115A/S

#### Compact Auto

#### Shoe Mount Flash with Slave

- ◆ Built-in slave for automatic synchronization with on camera flash
- ◆ Automatic exposure range
- ◆ Manual exposure operation
- ◆ Guide no. 48 (ft. ISO100)
- ◆ Runs on 2 AA batteries
- ◆ Includes PC sync cord

AC115AS.....34.95



### 260T

#### Auto Shoe Mount Flash

A medium sized, non-dedicated flash designed with the needs and budget of the advanced amateur in mind.

- ◆ Compact bounce and zoom head
- ◆ 3 automatic exposure ranges
- ◆ Guide no. 88 (ft. ISO 100)
- ◆ Energy saving thyristor circuitry
- ◆ Includes color filters and diffuser
- ◆ Includes PC sync cord
- ◆ Runs on 4 AA batteries (not included)

AC260T .....39.95

### 321AZ

#### Auto Shoe Mount Flash

Compact size, flash with a bounce head that adjust from 0 to 90°. The 321AZ auto flash is an outstanding value.

- ◆ Compact bounce head ◆ 2 automatic exposure ranges
- ◆ Guide no. 64 (ft. ISO 100)
- ◆ Includes PC sync cord, color filters and diffuser
- ◆ Runs on 4-AA batteries (not included)

321AZ Auto Shoe Mount Flash (AC321AZ).....34.95



### DZ260

#### Dedicated TTL Shoe Mount Flash



A fully TTL dedicated auto thyristor flash, the DZ260 has a bounce adjustment from 0-90° and a zoom flash range from 28mm (with the supplied diffuser) to telephoto. An extremely versatile medium sized flash.

- ◆ Fully dedicated TTL operation
- ◆ 2 automatic ranges (for non-dedicated operation)
- ◆ 3-positions bounce and zoom head
- ◆ Guide no. 112 (ft. ISO 100)
- ◆ Incorporates energy saving thyristor circuitry
- ◆ Includes PC sync cord, color filters and diffuser
- ◆ Runs on 4-AA batteries (not included)

DZ260 TTL Shoe Mount Flash: For Minolta (ACDZ260M) and Pentax (ACDZ260P) .....59.95

### 940AF

#### Dedicated TTL Power Zoom Shoe Mount Flash

The 940LCD is a sophisticated programmed electronic flash that combines a wide range of impressive features with an easy to use, motor driven zoom head. Automatically adjusts to match the focal length of your autofocus SLR camera.

- ◆ Bounce and auto zoom head automatically adjusts flash to match the focal length of lens in use from 28 to 85mm
- ◆ 330° swivel
- ◆ Infrared autofocus assistance beam
- ◆ Multiple TTL auto ranges
- ◆ Guide no. 90-132 (ft. ISO 100)
- ◆ Manual mode variable power down to 1/8th
- ◆ Incorporates energy saving thyristor circuitry
- ◆ Includes color filters and diffuser
- ◆ Rear-curtain sync
- ◆ Illuminated LCD panel for convenience
- ◆ Runs on 4-AA alkaline or nicad batteries

#### 940AF Dedicated TTL Power Zoom Shoe Mount Flash

For Minolta Maxxum (AC940MAF) and Nikon AF (AC940NAF) .....139.95

For Canon EOS (AC940CAF) .....119.95





# CLOUD DOME

## PORTABLE LIGHTING STUDIO

### Portable Lighting Studio for Digital and Analog Cameras

A studio-in-a-bag, Cloud Dome is the simplest way to take professional-quality photographs without complicated lighting. It's portable and convenient- an idea brought to life by an enterprising jewelry artist and her weather-loving father. Made of high impact, non-yellowing, crack-resistant plastic. Cloud Dome evenly diffuses natural light over the surface area of the object being shot. Lightweight and easily portable, the Cloud Dome is outfitted with a camera mount to eliminate any stability problems.

The Cloud Dome Professional has an 82mm opening to accommodate larger format cameras. The Cloud Dome is 10" high with a diameter of 15". For photographing larger objects extension collars are available in 7", 12" and an angle collar.

#### Professional 82mm Cloud Dome (CD82)

With an 82mm opening. Includes a base plate and larger "L" .....174.95



FLASHES & ACCESSORIES

217

**7" Straight Extension Collar (CDECS)**  
Helpful for photographing larger objects, as well as for cameras with focal distances greater than 8" .....37.95

**12" Straight Extension Collar (CDECI2)**  
Same as the 7" collar, but it adds 12" to the height of the Cloud Dome .....39.95

**Angled Extension Collar (CDECA)**  
Includes a 7" extension collar. Allows you to photograph 3-dimensional items at an angle when used with the Cloud Dome .....38.95

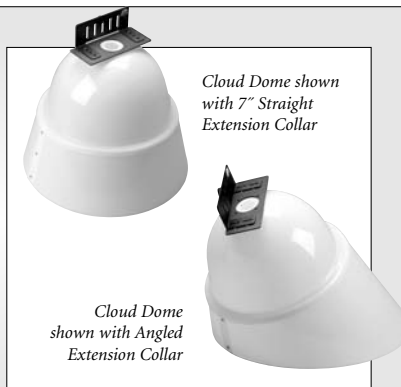

#### Cloud Dome Applications

- ◆ Portable and convenient, the Cloud Dome is lightweight and easy to take in the field or use at home
- ◆ Perfect for photographing many types of objects:
  - Sports memorabilia
  - Jewelry
  - Stamps
  - Fossils
  - Documents
  - Stock and bond certificates
  - Artifacts
  - Gems and minerals
  - Circuit boards
  - Foliage
  - Great for Many Applications
  - Selling items via online auctions
  - Record structural damage
  - Patent applications
  - Insurance
  - Forensic pathology
  - Archeology
  - Evidence recording

### Infinity Board Lighting Kit



The Infinity Board Lighting Kit is a mini studio that sets up quickly for lighting and shooting small objects. The matte finish of the included 18 x 28" Infinity board allows photographing products with seemingly no background. The board may be used flat or adjusted into infinite U-shapes, is washable, and scratch proof. The two Flip Lights are 19" long folding fluorescent fixtures, each with a 13 watt compact fluorescent (5000° K) bulb. They each shut off automatically when folded.

**Infinity Board Lighting Kit (CLIBDLKW)**  
Matte White Flexible Background .....89.95

**Infinity Board Lighting Kit (CLIBDLKB)**  
Matte Black Flexible Background .....89.95

ORDER & INFO. (212) 502-6340 • FAX: (212) 239-7770 (800) 947-7008  
1-800-290-6750 • www.bhphotovideo.com



# METZ

## SHOE MOUNT FLASHES

### 20BC-6 Compact Auto Shoe Mount Flash

The perfect beginners model, the BC-6 is a great and inexpensive way to enhance lighting and get great pictures. Designed to work with non-AF cameras, the BC-6 is an excellent mate for fill flash duty or use with fast films. Compact and easy to use, with a quite usable 28mm coverage angle. It weighs 5 oz.



- ◆ Guide Number 66
  - ◆ Works with all cameras with middle-contact hot-shoe or PC sync.
  - ◆ Manual flash mode allows full light output with the given guide number
  - ◆ In Auto Flash Mode a sensor measures the light reflected by the subject and shuts off the flash as soon as the subject has been correctly lit.
  - ◆ Flash ready and correct exposure indicator
  - ◆ Supplied 28mm wide angle attachment increases the illumination angle
  - ◆ 8-second recycle time, uses 3 AA batteries
- ME20BC6.....54.95

Based on their expertise in electronics and plastics technologies, Metz has built an excellent reputation over the years, and continues to maintain their leadership with an extremely wide-ranging product range. From handy compacts to high performance hand-held flashguns, you will find the proper light for every situation. And, for nearly every camera, because the well-developed SCA system guarantees that Metz flash units can be used on practically every SLR camera. The camera can change – the Metz stays!

### 36-M1 Manual Shoe Mount Flash

The 36 M-1 is the scaled-down all-manual version in the the Metz 36 series, and is available at an excellent price/performance ratio. The integrated zoom reflector can be manually adjusted to the given focal length (between 28 and 85 mm), and the reflector can be tilted a vertical direction 90°. It is a great flash for when no dedication is required. The flash also features a manual aperture calculator. Weighs 7 oz. Includes sync cord.



- Guide No. 98 at 50mm, 118 at 85mm
  - ◆ Flash ready and correct exposure indicator
  - ◆ Manual flash mode allows full light output with the given guide number
  - ◆ Battery tester indicates – at the touch of a button– if battery capacity is sufficient
  - ◆ 5-second recycle time, uses 4 AA batteries
- ME36M1 .....69.95

#### About the Guide Number

The range of a flash unit is determined by the guide number. The higher the number, the wider the range. Pay close attention when making comparisons however, that the indication is based on the same focal length. If you wish to increase the range of your flash unit, then you may consider using a film with higher sensitivity, because they require less light! This effect is excellent for use in manual mode. The higher sensitivity is adjusted on the flash unit.

### 36C-2 Auto Slave/Manual Shoe Mount Flash

The 36C-2 is the automatic flash unit version in the the Metz 36 series, and features three different auto-working apertures (f/8, f/4, f/2 at ISO 100/21°). Furthermore, the integrated zoom reflector can be manually adjusted to the given focal length (between 28 and 85mm), and the reflector can be tilted in a vertical direction 90°. Includes sync cord.



- ◆ Guide Number 98 at 50mm, 118 at 85mm
  - ◆ Cobra design reduces red eye effect
  - ◆ Automatic and manual flash modes
  - ◆ Flash ready and correct exposure indicator
  - ◆ Battery tester indicates – at the touch of a button– if battery capacity is sufficient
  - ◆ 5-second recycle time, uses 4 AA batteries
- ME36C2.....99.95



For Any Inquiries Regarding Your Order, Call Our Customer Service:  
(800) 221-5743 • (212) 239-7765 • FAX: (800) 947-2215 • (212) 239-7549

## SHOE MOUNT FLASHES

### 44MZ-2 Auto/Manual Shoe Mount Flash

The 44MZ-2 is an SCA-capable auto/manual flash with a powerful auto-zoom flash head. Logical menu control makes it easy to select TTL, automatic and manual flash modes. Used in connection with the SCA-3002 adapter system, the 44MZ-2 will work with virtually any analog SLR camera as well as with Minolta, Nikon, Olympus and Sony digital cameras. Eight partial light output levels can also be set at the touch of a button. Activate TTL mode and the 44MZ-2 delivers perfect flash without any additional settings. Daylight fill-in flash brightens up dense shadows and rear curtain sync delivers faithful rendering of effects. Other functions include (in so far they are supported by the camera): ADI flash control and multi-zone flash metering (Minolta), matrix-controlled fill-in flash and under-exposure indication by way of aperture (Nikon), measuring flash function (Leica), TTL preflash (Contax), contrast control and spot-beam mode (Pentax).



- ◆ Guide Number 111 at 50mm, 144 at 105mm
  - ◆ The slim Cobra design minimizes the danger of red-eye effect because the flash and exposure axis are spaced more widely apart so that reflections from the retina at the back of the eyes are almost completely avoided.
  - ◆ Power Zoom automatically adjusts the flash reflector to the corresponding lens focal length (in connection with the SCA-3002 adapter). The integrated zoom reflector guarantees optimal light output within 28-105mm.
  - ◆ Focal length can be further reduced down to 20mm with an optional wide-angle diffuser.
  - ◆ Rear curtain synchronization for natural blur effects (with optional TTL module, where supported by camera).
  - ◆ TTL Fill-in flash control reduces subject contrasts that are too high (for example by lightening up areas with strong shadow caused by bright sunshine).
  - ◆ Wake-up function switches the flash on after a break just by tapping on the release button.
  - ◆ Tilt and swivel reflector can be adjusted within the given range both horizontally and vertically (to provide indirect flash lighting). Also downward tilt for macro illumination.
  - ◆ A buzzer goes off if there is an incorrect adjustment or to signal flash readiness.
  - ◆ Built-in exposure safeguards such as distance failing to show when flash is pointed up
  - ◆ Key Function locks the operating settings to protect against unintended adjustments
  - ◆ Battery tester indicates — at the touch of a button — shows battery capacity.
  - ◆ Automatic cut-off saves energy if you've forgotten to turn off the flash, or during longer periods between usage
  - ◆ 5-second recycle time, runs on 4 AA batteries
- 44MZ-2 (ME44MZ2): With hot shoe table stand.....195.00**

FLASHES & ACCESSORIES

219



### 34AF-3 TTL Dedicated Shoe Mount Flash

For anyone who wants a combination of style, quality and compactness (fits into a shirt pocket) from their flash. The chic 34AF-3 delivers with its simple operation, powerful guide number, TTL operation and telephoto or wide-angle attachments. And of course it includes the specific special functions for AF SLR cameras from Canon, Minolta, Nikon and Pentax. Take it with when you don't need a bigger flash.

- ◆ Guide No. 92 at 35mm, 111 at 85mm
- ◆ 6-second recycle time
- ◆ TTL operation measures the flash illumination right on the film and adjust the flash exposure perfectly (Canon version is capable of E-TTL operation when used with E-TTL EOS bodies).
- ◆ Flash ready and correct exposure indicators. LED display indicates the settings and adjustments that should be/have been taken.
- ◆ Manual flash mode allows full light output with the given guide number
- ◆ Wake-up function makes switching on a flash after a long break possible just by tapping on the camera release button.
- ◆ Individual color scheme to match the metallic colors of the cameras
- ◆ Includes changeable 24mm wide angle diffuser and 85mm telephoto lens attachment
- ◆ Runs on two CR2 3-volt lithium batteries (included)

#### PRICING

|  |               |
|--|---------------|
| <b>34 AF-3 (ME34AF3CAF)</b><br>For Canon EOS ..... | <b>148.95</b> |
| <b>34 AF-3 (ME34AF3NAF)</b><br>For Nikon AF .....  | <b>CALL</b>   |
| <b>34 AF-3 (ME34AF3MAF)</b><br>For Maxxum .....    | <b>CALL</b>   |
| <b>34 AF-3 (ME34AF3PAF)</b><br>For Pentax AF ..... | <b>CALL</b>   |

## SHOE MOUNT FLASHES

### 36AF-3 TTL Dedicated Shoe Mount Flash

Achieving excellence for the occasional photographer, the 36AF-3 (dedicated for Canon, Nikon, and Minolta cameras) is housed in a modern and trendy cobra design and gives super-precision TTL operation for maximum exposure accuracy. By measuring the flash light at the film plane, light emission is always matched perfectly to the given subject, making a great image every time. Furthermore, the integrated zoom reflector can be manually adjusted to the given focal length (between 28 and 85mm), optimizing light output with a simple setting.



- ◆ Guide Number 98 at 50mm, 118 at 85mm
- ◆ Cobra-design reduces red eye effect
- ◆ Zoom reflector works in 28-85 mm range, reflector can be tilted 90°
- ◆ Integrated AF measuring beam
- ◆ Manual flash mode allows full light output with the given guide number
- ◆ TTL operation measures the flash illumination right on the film and adjust the flash exposure perfectly.
- ◆ Automatic TTL fill-in flash function (depends on camera type)
- ◆ Automatic X-sync shutter speed control
- ◆ Flash ready indication (also in the camera view finder), correct exposure indicator
- ◆ Automatic cut-off saves energy if you've forgotten to turn off the flash after using, or during longer periods between usage
- ◆ 5-second recycle time
- ◆ Runs on 4 AA batteries

**36AF-3C (ME36AF3CAF)**

For Canon EOS .....142.95

**36AF-3C (ME36AF3MAF)**

For Minolta Maxxum .....142.95

**36AF-3C (ME36AF3NAF)**

For Nikon AF.....142.95



### 44AF-4 TTL Dedicated Shoe Mount Flash

The 44AF-4 is the choice for speed and simplicity. Pop in four AA batteries (any kind), mount it to the camera's hot shoe, turn it on and start shooting. The camera takes care of everything else from setting the ISO, zoom position, and ultimately the exposure. The 44AF-4 is very user-friendly with only two function keys for straightforward menu control. Features include TTL auto-zooming; manual, selectable partial light output levels; plus special functions such as daylight fill-in flash. It also features rear curtain sync and the ability to manually set the zoom setting for non-auto-zooming lenses. The illuminated LCD panel is large and easy-to-read and only displays the pertinent mode information. The sleek

Cobra design provides professional quality light output by tilting the head up 2° and using a Fresnel lens that redirects the light back to the subject. Even so, the flash can still be folded completely flat to fit any pocket.

- ◆ Large bounce/tilt flash head includes a built-in auto zoom that automatically adjusts with lenses in the 28-105mm range, while producing a GN of 144 (feet) at ISO 100 at maximum zoom setting and a GN of 112 (feet) at ISO 100 at 50mm.
- ◆ Tilt and swivel reflector can be adjusted within the given range both horizontally and vertically (used to provide indirect flash lighting).
- ◆ Extended zoom can set the illumination angle at one level higher than the zoom setting on the camera. Manually set the zoom setting for non-auto-zooming lenses.
- ◆ Rear curtain sync- important for controlling blurring effects of action shots.
- ◆ Integrated AF Assist Beam makes automatic focus adjustment with the SCA-3002 adapter by AF-SLR cameras possible.
- ◆ TTL Fill-in flash control reduces subject contrasts that are too high (for example by lightening up areas with strong shadow caused by bright sunshine).
- ◆ More control is possible by switching to manual mode and setting partial light output levels when the need arises.
- ◆ A buzzer goes off if there is an incorrect adjustment or to signal flash readiness.
- ◆ Automatic cut-off saves energy if you forgot to turn off the flash. A battery tester indicates whether battery capacity is sufficient.
- ◆ Switch on the flash after a long break just by tapping on the camera release button.
- ◆ Key Function locks the operating settings
- ◆ 5-second recycle time

**44 AF-4 (ME44AF4MAF):** With hot shoe table stand for Minolta Maxxum .....189.95

**44 AF-4 (ME44AF4CAF):** With hot shoe table stand for Canon EOS .....189.95

**44AF-4N (ME44AF4ND):** With hot shoe table stand for Nikon AF .....189.95



**EQUIPMENT LEASING AVAILABLE**

## SHOE MOUNT FLASHES

### 54MZ-4 TTL Dedicated Shoe Mount Flash

The flagship model in the Metz shoe mount series, the 54MZ-4 offers cutting edge technology with features such as Nikon's 3-D multi sensor TTL metering, Canon's E-TTL flash control, and high-speed synchronization (HSS).

The 54MZ-4 is available with a standard single pin shoe, or as a kit with your choice of SCA 3002 modules for Canon, Minolta, Nikon or Pentax. However, the 54MZ-4 remains user-friendly with only two buttons and a single thumb wheel to control the logically arranged menu system. The illuminated LCD panel is large and easy-to-read and only displays the pertinent mode information. Special features include the display of focal length for the lens in use in the LCD screen, display in feet or meters, auto flash bracketing, auto shut-off, and lockable keypad eliminating accidental setting changes.



#### Step-up features from the 44 AF-4

- ◆ The main flash's Auto Zoom feature works with lenses in the 24-105mm range, producing a GN of 177 (feet) at ISO 100 at maximum zoom setting and a GN of 131 (feet) at ISO 100 at 50mm.
- ◆ A secondary reflector fills in the shadows in close-up areas that are created when using an indirect flash. It can also be used to produce wrap around lighting when the main flash, with its built-in tilt/swivel function, is bounced off a wall or ceiling.
- ◆ Automatic Flash Program provides automatic adjustment of the optimal time/f-stop/flash exposure combination.
- ◆ Compatible with SCA-300 and SCA-3002 adapter systems
- ◆ Automatic flash bracketing with  $\pm 3$  apertures in one-third steps
- ◆ Partial Light Output Mode for reduced light output or for fixed flash lighting times.
- ◆ Offers nine different automatic settings as well as a variable Manual mode, offering ratios down to 1/256th power.
- ◆ Large, easy-to-read illuminated LCD panel only displays pertinent mode information.
- ◆ Displays lens focal length in the LCD screen. The display can be adjusted from feet to meters, or to various film/digital formats.
- ◆ Canon version offers HSS (High Speed Synchronization). This lets you use the flash with shutter times that are higher than the X-sync shutter speed of the camera.

|  |        |
|--|--------|
| 54MZ-4 (ME54MZ4): With Standard Non-Dedicated Shoe ..... | 319.95 |
| 54MZ-4 (ME54MZ4CAF)<br>For Canon EOS.....                | 399.95 |
| 54MZ-4 (ME54MZ4NDZ)<br>For Nikon AF .....                | 399.95 |
| 54MZ-4 (ME54MZ4MAF)<br>For Minolta Maxxum .....          | 399.95 |
| 54MZ-4 (ME54MZ4PAF)<br>For Pentax AF .....               | 399.95 |

### 54AF-1 Digital TTL Dedicated Shoe Mount Flash

The 54 AF-1 Digital was developed for digital and film cameras. Ergonomics are straightforward, with most features operable with only one button. Easy to operate, yet it offers a range of advanced features, like stroboscopic modeling light, three partial light output levels, 1st and 2nd curtain sync and HSS high speed sync. It also represents the state-of-the-art in flash technology. New internal precision metering methods ensure perfect flash exposures with either Nikon's D-TTL, 3D/D-TTL, i-TTL and i-TTL-BL systems for its digital cameras, including the D70; with Canon's E-TTL system for its EOS and PowerShot series cameras; with Konica/Minolta's AD system for its Dimage series cameras.



- ◆ "Cobra Design" flash reduces the redeye effect
- ◆ Autozoom head can cover from 24 to 105mm, and 20mm when used with the optional wide angle diffuser
- ◆ Flash tilts downward to better illuminate close-up subjects
- ◆ High-speed flash synchronization allows flash to be used with any shutter speed (with appropriate camera bodies)
- ◆ Wireless full TTL triggering
- ◆ E-TTL Evaluative preflash metering and stroboscopic modeling light for previewing effect

|  |        |
|--|--------|
| 54 AF-1 (ME54AF1CAF)<br>For Canon EOS..... | 289.95 |
| 54 AF-1 (ME54AF1ND)<br>For Nikon AF .....  | 289.95 |
| 54 AF-1 (ME54AF1MAF)<br>For Maxxum .....   | 289.95 |

# METZ

## HANDLE-MOUNT FLASHES

### 45 CL-1 / 45 CL-4

Compact and easy to hold, the 45 series can light up a room, and are an excellent choice for professionals. Shooting in the vertical or horizontal position still allows the light to be above and to the side of the lens' center. Built to withstand years of harsh use and abuse, the 45 CL-1 offers high light output (GN 148) and simple handling. 5 auto apertures are available. Intended for the owners of non-AF and SLR cameras without special flash features. The big brother of the Metz 45 CL-1, the 45 CL-4 offers 6 auto apertures as well as an additional secondary reflector. It is intended for owners of AF as well as for non-AF SLR cameras. Fully dedicated with the SCA 300, the 45CL-4 also integrates with the advanced SCA 3002 system modules when used with converter cable SCA 3000C. Both come supplied with wide angle attachment, sync cord, camera bracket and AA battery holder.



- ◆ Flash ready and correct exposure indicator
- ◆ Automatic and manual flash modes
- ◆ Includes a wide angle attachment
- ◆ LCD /LED display indicates the settings and adjustments that should be/have been taken.
- ◆ Tilt and swivel reflector can be adjusted within the given range both horizontally and vertically. (Used to provide indirect flash lighting).

#### 45 CL-4 Step-up Features:

- ◆ TTL operation measures the flash illumination right on the film and adjust the flash exposure perfectly.
- ◆ Partial Light Output Mode for reduced light output or for fixed flash lighting times
- ◆ Secondary reflector is available to fill-in the shadows in close-up areas that are created when using an indirect flash.
- ◆ Includes reduction filter for secondary reflector (5561)

45 CL-1 Auto Handle-Mount Flash (ME45CL1) .....279.95  
 45 CL-1 Flash Kit (ME45CL1N): Includes 45 CL-1 Handle Mount Flash, Nicad Cluster, Charger, Wide Angle Adapter, 15" PC Cord, Quick Release Bracket .....369.95

45 CL-4 TTL Handle-Mount Flash (ME45CLA) .....479.95  
 45CL-4 Flash Kit (ME45CL4N): Includes 45 CL-4 Handle Mount Flash, Nicad Cluster, Charger, Wide Angle Adapter, Light Reducing Filter, 15" PC Cord, Quick Release Bracket and AA Battery Holder.....572.95



### 60 CT-1 / 60 CT-4

The 60 series provides enough power for even the most demanding lighting situations. With a whopping guide number of 197, slow films and small apertures are no longer mutually exclusive with flash effect. Bounce or swivel the light, and use any of a host of accessories to change the angle, color or direction of light. Many battery power packs are available providing short recycle times and lots of shots between charges. It features high light output and quick flash follow-up time thanks to an external powerpack with dryfit rechargeable batteries. Stepping up, the 60 CT-4 is fully integrated in the SCA-300 or SCA-3002 (with SCA-3000C connector cable) and compatible with all leading camera brands. This enables a variety of special flash functions.

- ◆ Flash ready and correct exposure indicator
- ◆ Automatic and manual flash modes
- ◆ Includes a wide angle attachment
- ◆ LCD /LED display indicates the settings and adjustments that should be/have been taken.
- ◆ Tilt and swivel reflector can be adjusted within the given range both horizontally and vertically. (Used to provide indirect flash lighting).

#### 60 CT-4 Step-up Features:

- ◆ TTL operation measures the flash illumination right on the film and adjust the flash exposure perfectly.
- ◆ Secondary flash head is available to fill-in the shadows in close-up areas that are created when using an indirect flash.
- ◆ Includes reduction filter for second flash head (5562)
- ◆ Key Function locks operating settings, protects against unintended adjustments.
- ◆ Power Zoom automatically adjusts the flash reflector to the corresponding lens focal length (in connection with SCA-3002 adapter)
- ◆ A buzzer goes off if there is an incorrect adjustment or to signal flash readiness



## HANDLE-MOUNT FLASHES

### 70 MZ-5

The 70 MZ-5 is a professional flash characterized especially by its simplified operating philosophy: 2 function keys and one dial provide complete control of all flash modes. A logically ordered menu offers in addition to the already known functions special features such as: TTL or Nikon 3D multi - sensor mode, TTL flash exposure correction, stroboscope mode, integrated slave function, secondary reflector, modelling light, program memory for preferred adjustments, and rapid mode (for serial exposures). And depending on the camera, access to additional features such as: automatic flash bracketing function. Equally as meaningful, the extended key function for all keys, that completely prevents an accidental change in setting.



### FEATURES

- ◆ 3D Multi-sensor measurement for refined TTL flash exposure (specific to Nikon)
- ◆ AF Assist Beam integrated in the flash makes automatic focus adjustment (with the SCA-3002 adapter) by AF-SLR camera possible. (Also in complete darkness).
- ◆ Automatic and manual flash modes
- ◆ Automatic Flash Program provides automatic adjustment of the optimal time/f-stop/flash exposure combination.
- ◆ LCD /LED display indicates the settings and adjustments that should be/have been taken.
- ◆ Extended zoom lets you set the illumination angle at one level higher than the zoom setting on the camera.
- ◆ Key Function locks the operating settings to protect against unintended adjustments
- ◆ Manual zoom lets you set the illumination angle of the flash head by hand.
- ◆ Power Zoom automatically adjusts the flash reflector to the corresponding lens focal length (in connection with SCA-3002 adapter)
- ◆ Partial Light Output Mode for reduced light output or for fixed flash lighting times.
- ◆ An integrated sensor makes wireless flash operation possible in combination with an additional flash (slave) unit. Plus, remote automatic or remote TTL makes wireless operation of additional flashes possible in controller/slave mode.
- ◆ Automatic flash bracketing with (+/-) 3 apertures in one-third steps
- ◆ Rapid mode shortens the flash recycling time but with less light output
- ◆ Secondary flash head is available to fill-in the shadows in close-up areas that are created when using an indirect flash.
- ◆ Tilt and swivel reflector can be adjusted within the given range both horizontally and vertically. (Used to provide indirect flash lighting).
- ◆ TTL operation measures the flash illumination right on the film and adjusts the flash exposure perfectly.
- ◆ Stroboscope mode for flash sequences in selectable intensity, frequency and number of flashes (used for effect exposures and movement studies).
- ◆ Modelling light allows you to judge the illumination.
- ◆ Battery tester indicates whether battery capacity is sufficient.
- ◆ Rear sync on the second shutter curtain for natural blur effects.
- ◆ A buzzer goes off if there is an incorrect adjustment or to signal flash readiness.
- ◆ Automatic TTL fill-in flash function (depends on camera type)
- ◆ Automatic cut-off saves energy if you've forgotten to turn off the flash after using, or during longer periods between usage.
- ◆ Wake-up function makes switching on a flash after a long break possible just by tapping on the camera release button.
- ◆ Includes 20mm wide angle attachment

### 60CT-Series & 70MZ-5 HANDLE MOUNT FLASH KITS

**60CT-1 Flash Kit (ME60CT1):** Includes 60CT-4 Handle Mount Flash, Dryfit Battery, Battery Pack, Charger, Power Cord, Shoulder Strap, 20mm Wide Angle Diffuser (built-in), 15" PC Cord and Quick Release Camera Bracket.....**699.95**

**60CT-4 Flash Kit (ME60CT4):** Includes 60CT-4 Handle Mount Flash, Dryfit Battery, Battery Pack, Charger, Power Cord, Shoulder Strap, 20mm Wide Angle Diffuser (built-in), 15" PC Cord, Light Reducing Filter and Quick Release Camera Bracket .....**938.98**

**70MZ-5 Flash Kit (ME70MZ5):** Includes 70MZ-5 Handle Mount Flash, Nicad Battery and Charger, Quick Release Camera Bracket, Standard Base, 20mm Wide Angle Diffuser and Cover Plate .....**749.95**

# METZ

## FLASH SPECIFICATIONS

| Model #                                   | 20 BC-6          | 36 M-1           | 36 C-2           | 44 MZ-2        | 34 AF-3        | 36 AF-3          | 44 AF-4        |
|---|------------------|------------------|------------------|----------------|----------------|------------------|----------------|
| Guide Number With ISO 100/21° & 35/50mm   | 20 (35mm)        | 30 (50mm)        | 30 (50mm)        | 34 (50mm)      | 28 (35mm)      | 30 (50mm)        | 34 (50mm)      |
| Guide Number With ISO 100/21° & max. zoom | 20               | 36               | 36               | 44             | 34             | 36               | 44             |
| SCA 3002 System                           | —                | —                | —                | ✓              | —              | —                | —              |
| SCA 3000 System                           | —                | —                | —                | —              | —              | —                | —              |
| SCA 300 System                            | —                | —                | —                | ✓              | —              | —                | —              |
| Power Zoom                                | —                | —                | —                | ✓              | —              | —                | —              |
| Extended Zoom                             | —                | —                | —                | ✓              | —              | —                | —              |
| Manual Zoom                               | —                | ✓                | ✓                | —              | —              | ✓                | —              |
| Clip-on Wide Angle Attachment             | ✓                | —                | —                | —              | ✓              | —                | —              |
| Illumination Above...mm                   | 28               | 28               | 28               | 28             | 24             | 28               | 28 / 24        |
| Secondary Reflector                       | —                | —                | —                | —              | —              | —                | —              |
| Tilt And Swivel Reflector                 | Vertical in °    | +90°             | +90°             | -7 / +90°      | —              | +90°             | -7 / +90°      |
| Rotation Area                             | Horizontal in °  | —                | —                | —              | —              | —                | —              |
| Integrated AF Measuring Flash             | —                | —                | —                | ✓              | ✓              | ✓                | ✓              |
| LCD or LED Display                        | —                | —                | —                | LCD            | —              | —                | LCD            |
| Manual Flash Mode                         | ✓                | ✓                | ✓                | ✓              | —              | —                | ✓              |
| Tele-computer Apertures                   | 1                | —                | 3                | 12             | —              | —                | —              |
| TTL Mode                                  | —                | —                | —                | ✓              | ✓              | ✓                | ✓              |
| Stroboscopic Mode                         | —                | —                | —                | —              | —              | —                | —              |
| Partial Lighting Levels                   | —                | —                | —                | 8              | —              | —                | 1              |
| Rapid Mode                                | —                | —                | —                | —              | —              | —                | —              |
| Program Memory                            | —                | —                | —                | —              | —              | —                | —              |
| Key Function (key lock)                   | —                | —                | —                | —              | —              | —                | —              |
| Modelling Light                           | —                | —                | —                | —              | —              | —                | —              |
| Metz Remote Control Function              | —                | —                | —                | —              | —              | —                | —              |
| Metz Remote Slave Function                | —                | —                | —                | 1)             | —              | —                | —              |
| Buzzer                                    | —                | —                | —                | —              | —              | —                | —              |
| Correct Exposure Indicator                | —                | —                | ✓                | ✓              | ✓              | ✓                | ✓              |
| Automatic Cut-off                         | —                | —                | —                | ✓              | ✓              | —                | ✓              |
| <b>Power Sources</b>                      |                  |                  |                  |                |                |                  |                |
| Rechargeable Battery                      | —                | ✓                | ✓                | ✓              | —              | ✓                | ✓              |
| AA Alkaline Battery                       | ✓                | ✓                | ✓                | ✓              | —              | ✓                | ✓              |
| Lithium Battery                           | —                | —                | —                | ✓              | ✓              | —                | ✓              |
| Power Pack                                | —                | —                | —                | —              | —              | —                | —              |
| <b>Flash Recovery in Seconds</b>          |                  |                  |                  |                |                |                  |                |
| NiCd min. / max.                          | —                | 5 / 5            | 0.3 / 5          | 0.2 / 4        | —              | 0.3 / 3          | 0.2 / 4        |
| AA Alkaline Battery min. / max.           | — / 8            | 5 / 5            | 0.3 / 5          | 0.2 / 5        | —              | 0.3 / 5          | 0.2 / 5        |
| Lithium Batteries min. / max.             | —                | —                | —                | —              | 0.3 / 6        | —                | —              |
| Power Pack                                | —                | —                | —                | —              | —              | —                | —              |
| NiMH min. / max.                          | —                | 5 / 5            | 0.3 / 5          | 0.2 / 4        | —              | 0.3 / 5          | 0.2 / 4        |
| Weight                                    | 5.3 oz.          | 7.2 oz.          | 7.2 oz.          | 14.1 oz.       | 3.5 oz.        | 7.2 oz.          | 14.0 oz.       |
| Dimensions (LxHxD)                        | 2.9 x 2.1 x 3.4" | 2.8 x 4.5 x 3.8" | 2.8 x 4.5 x 3.8" | 3 x 4.9 x 4.3" | 2.4 x 4 x 1.4" | 2.8 x 4.5 x 3.8" | 3 x 4.9 x 4.3" |



## FLASH SPECIFICATIONS

| Model #                                   | 54 MZ-4         | 54 AF-1           | 45 CL-1        | 45 CL-4        | 60 CT-1                         | 60 CT-4                         | 70 MZ-5                              |
|---|-----------------|-------------------|----------------|----------------|---------------------------------|---------------------------------|--------------------------------------|
| Guide Number With ISO 100/21° & 35/50mm   | 40 (50mm)       | 131               | 45 (35mm)      | 45 (35mm)      | 60 (35mm)                       | 60 (35mm)                       | 50 (50mm)                            |
| Guide Number With ISO 100/21° & max. zoom | 54              |                   | 45             | 45             | 60                              | 60                              | 70                                   |
| SCA 3002 System                           | ✓               |                   | —              | 2)             | —                               | 2)                              | ✓                                    |
| SCA 3000 System                           | —               |                   | —              | 2)             | —                               | 2)                              | —                                    |
| SCA 300 System                            | ✓               |                   | —              | 3)             | —                               | 3)                              | ✓                                    |
| Power Zoom                                | ✓               |                   | —              | —              | —                               | —                               | ✓                                    |
| Extended Zoom                             | ✓               |                   | —              | —              | —                               | —                               | ✓                                    |
| Manual Zoom                               | —               | —                 | —              | —              | —                               | —                               | —                                    |
| Clip-on Wide Angle Attachment             | ✓               |                   | ✓              | ✓              | ✓                               | ✓                               | ✓                                    |
| Illumination Above...mm                   | 20              |                   | 28             | 28             | 28                              | 28                              | 20                                   |
| Secondary Reflector                       | ✓               |                   | —              | ✓              | —                               | ✓                               | ✓                                    |
| Tilt And Swivel Reflector                 | Vertical in °   | -7 / +90°         | -7 / +90°      | +90°           | +90°                            | +90°                            | +90°                                 |
| Rotation Area                             | Horizontal in ° | 270°              |                | 360°           | 360°                            | 360°                            | 270°                                 |
| Integrated AF Measuring Flash             | ✓               |                   | —              | —              | —                               | —                               | ✓                                    |
| LCD or LED Display                        | LCD             | LCD               | —              | LED            | —                               | LED                             | LCD                                  |
| Manual Flash Mode                         | ✓               |                   | ✓              | ✓              | ✓                               | ✓                               | ✓                                    |
| Tele-computer Apertures                   | 12              |                   | 5              | 6              | 6                               | 8                               | 12                                   |
| TTL Mode                                  | ✓               |                   | —              | ✓              | —                               | ✓                               | ✓                                    |
| Stroboscopic Mode                         | ✓               |                   | —              | —              | —                               | —                               | ✓                                    |
| Partial Lighting Levels                   | 25              |                   | —              | 2              | —                               | 25                              | 25                                   |
| Rapid Mode                                | —               |                   | —              | —              | —                               | —                               | ✓                                    |
| Program Memory                            | —               |                   | —              | —              | —                               | —                               | ✓                                    |
| Key Function (key lock)                   | ✓               | ✓                 | —              | —              | —                               | ✓                               | ✓                                    |
| Modelling Light                           | ✓               | ✓                 | —              | —              | —                               | —                               | ✓                                    |
| Metz Remote Control Function              | ✓               |                   | —              | —              | —                               | —                               | ✓                                    |
| Metz Remote Slave Function                | 1)              |                   | —              | —              | —                               | —                               | ✓                                    |
| Buzzer                                    | ✓               |                   | —              | —              | —                               | ✓                               | ✓                                    |
| Correct Exposure Indicator                | ✓               |                   | ✓              | ✓              | ✓                               | ✓                               | ✓                                    |
| Automatic Cut-off                         | ✓               | ✓                 | —              | —              | —                               | —                               | —                                    |
| <b>Power Sources</b>                      |                 |                   |                |                |                                 |                                 |                                      |
| Rechargeable Battery                      | ✓               | ✓                 | ✓              | ✓              | ✓                               | ✓                               | ✓                                    |
| AA Alkaline Battery                       | ✓               | ✓                 | ✓              | ✓              | —                               | —                               | —                                    |
| Lithium Battery                           | ✓               | —                 | —              | —              | —                               | —                               | —                                    |
| Power Pack                                | ✓               | ✓                 | ✓              | ✓              | —                               | —                               | ✓                                    |
| <b>Flash Recovery in Seconds</b>          |                 |                   |                |                |                                 |                                 |                                      |
| NiCd min. / max.                          | 0.1 / 5         | 0.1 / 5           | 0.7 / 8        | 0.3 / 7        | 0.25 / 5                        | 0.25 / 5                        | 0.1 / 5                              |
| AA Alkaline Battery min. / max.           | 0.1 / 6         | 0.1 / 6           | 0.3 / 15       | 0.3 / 13       | —                               | —                               | —                                    |
| Lithium Batteries min. / max.             | —               | —                 | —              | —              | —                               | —                               | —                                    |
| Power Pack (min. / P 40 max. / P 50 min.) | 0.1 / 6 / 2.5   |                   | 0.3 / — / 2.5  | 0.3 / — / 2.5  | —                               | —                               | 0.1 / — / 3                          |
| NiMH min. / max.                          | 0.1 / 5         | 0.1 / 5           | —              | —              | —                               | —                               | 0.1 / 5                              |
| Weight                                    | 16.9 oz.        | 1.4 lbs (w/batt.) | 24.0 oz.       | 24.0 oz.       | 22.9 oz.                        | 22.9 oz.                        | 31.0 oz.                             |
| Dimensions (WxHxD)                        | 3 x 4.9 x 4.3"  | 4.3 x 4.9 x 3     | 3.6 x 9.7 x 4" | 3.6 x 9.7 x 4" | 4.4 x 10 x 5"<br>6.5 x 5 x 2.3" | 4.4 x 10 x 5"<br>6.5 x 5 x 2.3" | 4.9 x 9.6 x 4.6"<br>2.6 x 1.4 x 3.5" |

## FLASH ACCESSORIES

### CORDS & CABLES

Metz offers a full line of PC cords and power cables to add functionality to your camera outfit.

**MZ-5355** (ME5355):

20" coiled (extends to 6') power cable V45 connects P50 power-pack to 45 series flash.....**36.50**

**MZ-5520** (ME5520):

12" coiled PC cable connects the 45CT-1 to sync terminal. Extends to 3' .....**22.95**

**MZ-5521** (ME5521):

12" coiled (extends to 3') PC cable connects the 45CL-1/3/4 and 60CT-4 to sync terminal .....**19.95**

**PA-5521HD** (ME5521HD):

26" heavy-duty coiled (extends to 4.5') PC cable connects the 45CL-3/4 and 60CT-4 to sync terminal .....**29.50**

**MZ-5524** (ME5524):

18" coiled (extends to 3') PC cable connects the 45CT-5 and 60CT-1/2 series to sync terminal.....**26.50**

**PA-5524HD** (ME5524HD):

24" heavy-duty coiled (extends to 4.6') PC cable connects the 45CT-5 and 60CT 1/2 series to sync terminal .....**33.95**

**MZ-5525** (ME5525):

3' straight PC cord connects the 32CT4, 45CL-1/3/4/, 45CT-3/4 and 60CT-4 to sync terminal.....**19.50**

**MZ-5528** (ME5528):

12" coiled (extends to 4') power cable from 60 Series power packs to Flash Head.....**38.50**

**MZ-5530** (ME5530):

PC extension cord. It attaches to a standard PC cord and extends its length by 15' .....**22.95**

**MZ-5532** (ME5532):

Connecting cable from 60 Series packs to flash head (repl.)...**33.95**

**MZ-5534** (ME5534):

12" coiled PC Cord with a sub-mini end that connects the 20BC-6 to the sync terminal. Extends to 3' .....**24.95**

**MZ-5548** (ME5548):

12" straight PC cable with sub-mini end connects 34 CS-2, 20, 32, 40, 50, 54 and 70-series flashes to sync terminal .....**16.95**

**MZ-5549** (ME5549):

9' straight PC cord for 45CL-1/3/4, 45C-T3/4 and 60CT-4 (Replacement).....**14.50**

**MZ-5533** (ME5533):

10" straight power cable for 60 Series power packs .....**34.95**

**MZ-5554** (ME5554):

12" Straight PC cable for 45CT-5 and 60CT-1/2 .....**33.95**

**MZ-5552** (ME5552):

12" Straight PC cable for 45CT-1.....**19.95**

**MZ-5575** (ME5575):

9.6' straight power cord for 60CT4 for use with multiple AC Adapters (5319).....**33.95**

**MZ-5591** (ME5591)

SCA 3000A Hot shoe to G16 Power Grip adapter cord with 13" coiled cable (extends to 4.6') Built-in AF sensor retains accuracy of focus .....**64.95**

**MZ-55450** (ME55450):

20" coiled (extends to 6') power cable V54-50 connects P50 powerpack to 54MZ-3.....**36.50**

**MZ-55440** (ME55440):

8" coiled (extends to 4.5') power cable V54-50 (with belt-clip) connects P50 powerpack to 54MZ-3.....**56.50**



## SCA 3002 / SCA 300 ADAPTERS

### SCA 3002 Adapters

All SCA 3002 modules are programmable. As camera models change versions or new models come out, the photographer will simply have the module reprogrammed. No more having to trade-in or throw away the modules. The SCA 3002 modules offer even more flexibility than its predecessor, the SCA 3000 system, including compatibility with E-TTL, 3-D modes, and the new "High Speed Synchronization" for use with Canon's E-TTL-HSS and Minolta/Nikon's TTL-HSS system. The modules are also backwards compatible. This means that they will work with the 32Z/32MZ, 40MZ, and 50MZ series flashes, and also with the SCA 3000C for 45CT/CL and 60CT-4 flashes.

**MZ-53102** (ME53102):

Canon Module SCA 3102 allows flash to work with dedicated Canon cameras. Supports E-TTL, 2nd curtain sync. Requires optional 3000C Cord to connect to 45CLA/60CT-4/G16 Grip .....**77.95**

**MZ-53302** (ME53302):

Minolta Module SCA 3302 allows flash to work with dedicated Minolta cameras (Sync and TTL). Requires optional 3000C Cord to connect to 45CLA/60CT-4/G16 Grip .....**77.95**

**MZ-53402** (ME53402):

Nikon Module SCA 3402 allows flash to work with dedicated Nikon cameras (Sync and TTL). Requires optional 3000C Cord to connect to 45CLA/60CT-4/G16 Grip .....**77.95**

**MZ-53502** (ME53502):

Leica Module SCA 3502 allows flash to work with dedicated Leica cameras (Sync and TTL). Requires optional 3000C Cord to connect to 45CLA/60CT-4/G16 Grip .....**92.95**

**MZ-53602** (ME53602):

Sony Module SCA 3602 allows flash to work with dedicated Sony cameras (Sync and TTL). Requires optional 3000C Cord to connect to 45CLA/60CT-4/G16 Grip .....**92.95**

**MZ-53702** (ME53702):

Pentax Module SCA 3702 allows flash to work with dedicated Pentax cameras (Sync and TTL). Requires optional 3000C Cord to connect to 45CLA/60CT-4/G16 Grip .....**77.95**



**MZ-53802** (ME53802): Contax Module SCA 3802 allows flash to work with dedicated Pentax cameras (Sync and TTL). Requires optional 3000C Cord to connect to 45CLA/60CT-4/G16 Grip .....**92.95**

**MZ-53202** (ME53202): Olympus Module SCA 3202 allows flash to work with dedicated Olympus cameras (Sync and TTL) .....**79.95**

### SCA 300 Adapters

Recommended for use with Metz flash units on non AF-SLR cameras from all normally available brands. Supports their specific flash special functions. (Can also be used on flash units that are intended for the SCA-3002 system. In this case not all of the special functions are available.)

**MZ-5480** (ME5480):

Nikon Module SCA 344 for all Nikon F3 series cameras (Sync and TTL). Connects to 45 and 60 Series, G15/G16 Grip and w/300E to shoe mount SCA units or 50 Series .....**119.95**

**MZ-5483** (ME5483):

Nikon Module SCA 343 for all Nikon EM, FA, FE, FG, and AF series cameras (except for F5 and Pronia). (Sync and TTL- where supported by camera). Requires 300A adapter cord (5484) to connect 45 and 60 Series, G15/G16 grip .....**66.95**

**MZ-5481** (ME5481):

Leica Module SCA 351 for all Leicaflex R4-R7 series cameras. (Sync and TTL- where supported by camera). Requires 300A adapter cord (5484) to connect 45 and 60 Series, G15/G16 grip .....**74.50**

**MZ-5482** (ME5482):

Ricoh Module SCA351 for or all Ricoh XR and KR series cameras. (Sync and TTL- where supported by camera). Requires 300A adapter cord (5484) to connect 45 and 60 Series, G15/G16 grip .....**42.95**

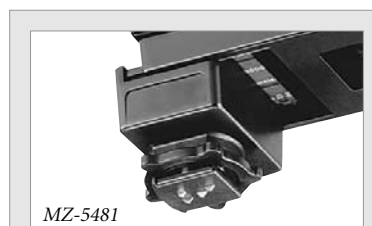

MZ-5481



MZ-5482



MZ-5483

**MZ-5489** (ME5489):

Contax, Yashica and Practica Module SCA382 for all Contax SLR and G series and all Yashica FX series Cameras. (Sync and TTL- where supported by camera). Requires 300A adapter cord (5484) to connect 45 and 60 Series, G15/G16 grip .....**49.95**

**MZ-5491** (ME5491):

Olympus Module SCA 321 for all Olympus OM series cameras. (Sync and TTL- where supported by camera). Requires 300A adapter cord (5484) to connect 45 and 60 Series, G15/G16 grip .....**59.95**

**MZ-5492** (ME5492):

Pentax Module SCA 372 for all A, LX, ME, MG, MV and SF series Pentax cameras. (Sync and TTL- where supported by camera). Requires 300A adapter cord (5484) to connect 45 and 60 Series, G15/G16 grip .....**49.95**

**MZ-5497** (ME5497):

Minolta Module SCA 331 for all Minolta X series, CLE, 5000, 7000, 9000 series cameras. (Sync and TTL- where supported by camera). Requires 300A adapter cord (5484) to connect 45 and 60 Series, G15/G16 grip .....**53.50**

### Batteries & Chargers

**NiMH Battery Cluster** (ME5325)

For 70MZ-4 and 70MZ-5 (100 full power flashes) .....118.50

**Power Pack P50** (ME5351)

A rechargeable microprocessor controlled battery pack, the P50 Power Pack combines faster recycling times with safe, reliable operation. Its charging control circuit prevents overcharging and offers automatic battery conditioning through its discharge/charging system, eliminating battery memory problems. The P50 generates a significant number of flashes at a much shorter recycling time than conventional power sources. It connects to the flash's AC outlet with the appropriate power connecting cable, and can be carried over the shoulder or attached to a belt using the built-in belt clip. Requires Power Cord 5356 for 50/70MZ Series; Power Cord 5355 for 45 Series; Power cord 55450 for 54 Series .....313.95



**Dual Voltage Charger for P50 Power Pack** (ME5352K)

Includes plug adapters for Europe, UK, USA and Australia .99.95

**Dedicated Module for Leica - SCA 3502** (ME53502)

Power Pack P50 with Dual Voltage Charger. Gives faster recycling time and more flashes per charge. (Requires 5355 V40 cable when used on 45 series flash and 5356 V50 cable for use with 70 series flash) .....92.95

**Battery Charger** (ME5310)

For 60 Series dryfit and nicad batteries and 45 Series nicad batteries .....57.95

**Replacement Battery Housing** (ME5316)

For 60 Series. Holds dryfit and nicad batteries.....426.95

**Replacement Battery Housing for External Charging** (ME5318)

For 60 Series. Holds dryfit and nicad batteries.....104.95

**Dryfit Battery Cell** (ME5320)

For 60 Series. Provides up to 4500 flashes .....64.95

**Nicad Battery Charger** (ME5309)

For MZ5313 (70 Series) nicad batteries .....74.50

**Nicad Battery** (ME5313)

For 70 Series. Provides 60 full power flashes per charge...67.95

**Nicad Battery Cluster** (ME5306)

For 45 Series. Includes charger .....76.95

**Nicad Battery Cluster** (ME5308)

For 45 Series .....59.95

**NiMH Battery Charger** (ME5326)

For MZ5327 .....74.95



### SCA Adapters and Converters

**MZ-5531** (ME5531)

SCA 300 flash to hotshoe adapter (12" coiled cable extends to 36") for 45CL-3/4, 60CT-4 and G16 Grip .....45.95

**MZ-5519** (ME5519)

SCA 301 Standard Hotshoe Module (replacement for standard hotshoe module) ....15.95

**MZ-5546** (ME5546)

SCA 300D Spacer to allow the use of 32CT7, 32MZ-3, 40 and 50 Series with SCA 300 AF and SCA 356 modules.....19.95

**MZ-5484** (ME5484)

SCA 300A Adapter connects 300 series modules to 45CT/CL-3/4 and 60CT-4 flashes connected to power grip. (12" coiled cable extends to 36") ...26.50



**MZ-53008** (ME53008)

SCA 3008A Coiled hot shoe to hot shoe extension cord (13" extends to 4.6-ft.) Built-in AF sensor retains accuracy of focus. (Replaces SCA 3007A).....98.95

**MZ-5592** (ME5592)

SCA 3000C/M1 Converter. 3002 Series module to 45 CT/CL 3/4 and 60CT4 when connected to G16 Power Grip. 13" coiled cable extends to 4.6' Built-in AF sensor retains accuracy of focus .....69.95

**MZ-5595** (ME5595)

SCA 300E Converter (converters SCA344, 373, 386 and 396 to SCA shoe mount and 50 series.....44.95

### Multi TTL & Cordless Slave



- MZ-5368** (ME5368)  
Mecalux II Auto Slave. Flash sensitive trigger with both hot shoe and PC cord connections. Powered by a solar cell — no batteries needed.....**78.50**
- MZ-5369** (ME5369)  
Mecalux holder to mount Auto slave on handle mount flash units.....**32.50**
- MZ-53083** (ME53083)  
SCA 3083 Digital Slave Adapter for “TTL” or “A” cordless control. The SCA 3083 digital slave adapter allows all current SCA-compatible Metz models (of the SCA 3002 and SCA 3000 system and hand held flash units of the SCA 300 adapter system with cable SCA 3000C) to be used for off-camera flash photography.....**54.50**
- MZ-5453** (ME5453)  
SCA V5 TTL 16’ extension cable attaches to 5451 and 5452.....**62.95**

### Brackets & Adapters

- G16 Power Grip** (ME5303)  
This power grip turns your shoe-mount flash into a handmount. It holds 4 “C”-size alkaline or nicad batteries.....**CALL**
- Replacement Quick Release Bracket** (ME5512)  
For 45, 50 and 60 Series flashes. Also for G15 and G16 Power Grips.....**29.95**
- Quick Release Connector** (ME5513)  
Spare quick release connector for MZ5512.....**29.95**

- Adjustable Bracket Adapter** (ME5517)  
For equal height positioning of handle-mount flash with camera lens. Designed for cameras with motor drive. Attaches to the quick-release bracket.....**43.50**
- Controller Bracket** (ME5518)  
For 70 Series. Used to hold controller on cameras without shoemount.....**24.50**



### Screens, Diffusers, Filters



- Bounce Screen** (ME55423)  
For 54MZ Series flashes.....**59.95**
- Soft Diffuser** (ME54490)  
Soft diffuser for 54MZ and 44 Series flashes. Provides softer, more natural lighting.....**24.50**
- Bounce Diffuser** (ME5422)  
For 70MZ-4 and 70MZ-5 handlemount flash.....**59.95**
- Color Filter Kit** (ME54432)  
For 54MZ-3. Kit includes red, blue, yellow and green filters plus holder for gelatin filters. Supplied with a soft pouch.....**54.95**
- Tele Attachment** (ME5415)  
For 60 series. Doubles the light output by concentrating the flash beam. With ISO 100 you can light subjects up to 211’ away.....**83.95**
- Removable 8x10” Reflector Screen** (ME5417)  
For 45 and 60 Series.....**44.95**
- ND Filter** (ME5561)  
For fill-flash on 45CT-4/5 and 60CT-4. Replacement.....**5.95**
- Tele Attachment** (ME5412)  
For 45 Series.....**94.95**

# NOVOFLEX

## NEW DIMENSION LIGHTING

### 3-D, Target and Diffused Flash Systems

With these three flash systems Novoflex offers the possibility to use artificial light in a closely controlled manner, enabling you to realize your photographic concepts. This new flash concept is based on a modular system. A compact generator with interchangeable shoes adapts to the automatic flash functions of most cameras. Different flash heads for each of the three techniques connect to the power pack.

- ◆ 3-D Flash replicates the characteristics of natural sunlight and creates dramatic three dimensional effects in your images. It is achieved with the "Flash Art" flash panel
- ◆ Targeted flash is achieved with the Auto-Duo-Flash with its' two flash heads for complete control of light and shadows.
- ◆ Diffused flash is possible with the Ring Flash head.



## FLASH ART

### Flat Flash Panel with Three-dimensional Light Output

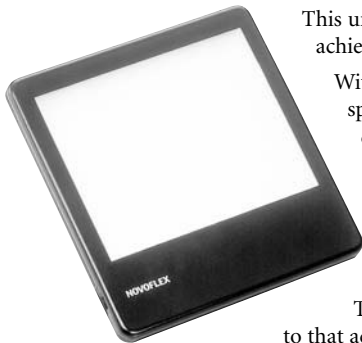

This unique, patented flash panel emits parallel rays, but as these are generated over the entire area of a flat panel, it achieves the characteristics of sunlight, particularly with regard to the shape and size of shadows.

With a guide number of 40 (ISO 100) you can shoot at f5.6 at a distance of 6.6', with a light creating stunning special effects. It is thus ideally suited for photographing interiors and for portraits, eliminating the need to create complex lighting structures. This flash also eliminates the red-eye effect as well as eliminates glare in most glasses or reflective objects.

In designing this flash, special attention was paid to ensure it was optimally adapted to the characteristics of the components in use with digital cameras.

The resulting definition is significantly superior to that achieved with conventional flashes.

Macro photography with this flash is possible using f16 (ISO 100) at ratios from 1:5 to 3:1. A built-in focus light allows both easier focussing in low light and a preview of the resulting illumination. As it is possible to use "Flash Art" at a distance of up to 18" from the optical axis, you have the ability to vary the lighting from almost completely shadowless to pure contrasted backlight. The various Novoflex flash-arms, -brackets etc. will aid you in positioning the flash in endless combinations.

The cord is 1.5' long, its dimension are 6.2 x 6 x 0.6" (WxLxH), and it weighs 15.2 oz. (less batteries for the modeling light panel).



Flat Flash Panel (NOFP): With case.....524.95

Flat Flash Panel (NOFPG): With case and Generator.....872.50



# NOVOFLEX

## NEW DIMENSION LIGHTING

### DUO FLASH (NODF)

#### Macro-Flash Studio for Target Flash

The proven compact flash studio with two separate flash heads enables you to achieve any desired lighting in the manner of a conventional studio with all imaginable variations. With a guide number of 92 (ISO 100), 66 per head, you have the choice to equip each flash with diffusion discs to obtain the required lighting characteristics. Both flash heads have cords of very generous length permitting use at a distance of up to 30" from the optical axis. This provides endless possibilities in targeting your light by direction, intensity and quality. By changing the distance from the optical axis, you are also provided with control over the resulting contrast. Everything is possible, from flat light similar to that of a ring flash, to cross flash and macro-flash studio photography (one main light and one for contrast/highlight control).

Duo-Flash can be used in a wide variety of applications, from portraits to extreme macro photography. Shooting at F16 (or F22 with 100mm lens) is possible at magnification ratios from 1:6 to several times life-size. Recommended accessories include the Duo-Flash holder or Flash Bracket with Two Flexible Arms. Cord length is 32" per head, dimensions are 2.5 x 3.3 x 2.2" per head, each head weighs 4 oz. ....224.95



**FLASHES & ACCESSORIES**

**231**

## GENERATOR

### Power Pack for Flash Art, Duo Flash & Ring Flash



All three Novoflex flash heads connect to a central power pack—the "Generator". It attaches to various cameras by interchangeable adapters. Power is provided by 4 AA batteries. An external power supply is optional.

- ◆ Energy consumption: 110-1350 flashes with alkaline batteries, 65-370 flashes with nicad batteries
- ◆ Flash sequence: 6-0.3 sec. ◆ Dimensions: 2.8 x 5 x 5.2" ◆ Weight: 12 oz.

**Generator Power Pack (NOPP):** For Flash Art, Duo Flash & Ring Flash .....362.95

The following interchangeable adapters are available:

|   |        |   |        |
|---|--------|---|--------|
| TTL Adapter for Canon (NOATTLGC).....                       | 86.95  | TTL Adapter for Nikon (NOATTLGN).....                 | 86.95  |
| Adapter for Canon EOS Cameras (NOAAFGC).....                | 119.95 | AF Adapter for Nikon Cameras (NOAAFNG).....           | 119.95 |
| TTL Adapter for Contax (NOATTLGCQ).....                     | 86.95  | TTL Adapter for Olympus (NOATTLGO).....               | 84.95  |
| Adapter for Minolta Cameras (NOAAFGM).....                  | 119.95 | TTL Adapter for Pentax (NOATTLGP).....                | 84.95  |
| AF Adapter for Minolta 5000, 7000 and 9000 (NOAAF5000)..... | 119.95 | Standard Non-Dedicated Hot Shoe Adapter (NOHSAG)..... | 86.95  |

## RING FLASH

### Diffused Shadowless Flash Light

The ring flash has a guide number of 46 (ISO 100) and is designed for use in situations where complete frontal lighting or flat, contrast-free light is required. The ring flash head is screwed into the filter thread of the lens (standard 52mm, other sizes with optional stepping rings). For extreme close-ups the shortest effective distance for the flash is 1.2" measured from the end of the filter thread. Cord length is 18" cord length, inside diameter dimensions are 3.5" and 4.7 x 1.2" overall, weighs 4 oz.

**Ring Flash (NORF).....**204.95  
**Ring Flash with Generator (NORFPP).....**473.50



**ORDER & INFO. (212) 502-6340 • FAX: (212) 239-7770 (800) 947-7008  
 1-800-290-6750 • www.bhphotovideo.com**



# NOVOFLEX

## FLASH SUPPORT

Novoflex has for many years provided the answer to the problem of positioning and holding flashes: Flash support systems of outstanding stability and adjustability from years of practical experience in the use of flash units and portability through low weight. Now Novoflex introduces the flash support system of the third generation: enormously flexible with minimum space required when on the move, yet infinitely versatile.



### The Flash Grip (NOFB)

Mounted on a base plate, the Flash Grip offers the facility to mount a large flash unit securely with ease, either screwed directly onto the ball head, or mounted in the detachable flash shoe. Of particular note are the possibilities of positioning the flash, and the secure handling of the entire assembly, aided by the fitted handstrap. To save maximum space on the move, the handgrip is detachable. Comes with a grip, strap and a ball head. Weighs 15.9 oz. complete .....142.50

The parts which make up the Flash-Grip are also available separately:

- Base Plate (X-BASIS):** 10 x 1.6 x 0.3", weighs 8.1 oz. (This is the same base plate used by the Duo Flash Holder, and both the Vertical and Horizontal Extension Sets) .....CALL
- Grip (X-GRIFF):** With handstrap but no ball head, weighs 5.6 oz .....CALL
- Ball and Socket Head (NOMBFS):** With flash accessory shoe, weighs 2.1 oz .....39.95

### Flash-Grip Extension Sets

To increase the flexibility of the flash mounting systems, Novoflex offers various extension sets for the Flash-Grip. This enables you to implement complex ideas without affecting the stability or compactness of the entire system.

#### Flash-Grip Extension Set I (NOEG8)

Rigid grip extension to achieve increased height of the flash by 8". Weighs 1.5 oz .....38.95

#### Flash-Grip Extension Set II (NOG102)

Flexible arm increases the height of flash and general position in relation to camera body by 9". This is mounted between the grip and the ball head. Weighs 10 oz.....52.95

#### Flash-Grip Extension Set III (NOEFG)

Variable rod to move the flash freely over a length of 10". As a result you can position the flash directly above the optical axis. But also at a distance of up to 12" from the camera. Whether you shoot in horizontal or vertical format, the flash can always be positioned optimally. Weighs 10 oz.....69.95



### Duo-Flash-Holder (NOHDF)

This is the product of lengthy tests and years of experience in the use of multiple flash. The Duo-Flash-Holder allows free positioning of two flash heads. With it you no longer have to compromise in terms of either ease of use or compactness and portability. Duo-Flash-Holder is the smart answer to these problems. Both flash units can be freely positioned and rapidly adjusted. The Base Plate is mounted to the camera bottom. The Vario-System is equipped with two ball and socket heads with flash accessory shoes, and can be freely twisted and moved along. As the ball and socket head can be mounted anywhere on the rods, you have an infinite variety of positions for your flash.

If the situation demands a change in the setup, this is achieved quickly. At the end of the shooting session, Duo-Flash-Holder is dismantled quickly and is ready to be stored out of the way in almost any gadget bag.

With other accessories from the Novoflex system you can turn the Duo-Flash-Holder into a small flash studio. It is recommended for all application utilizing the Novoflex Auto-Duo-Flash, Flash Art and virtually all commonly available flash units.

The Duo-Flash Holder weighs 13 oz., and is 14.2 x 1.6 x 3.2" when dismantled for storage....189.95

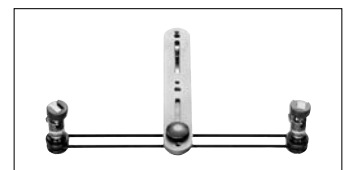
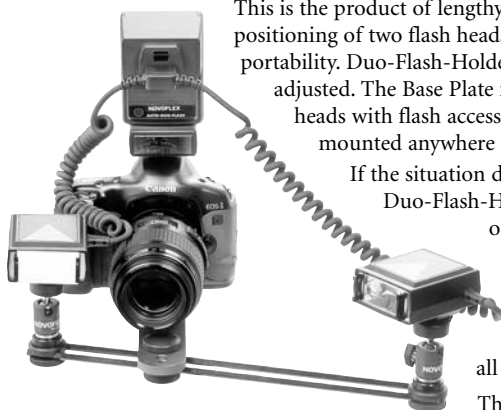



# NOVOFLEX

## FLASH SUPPORT

### Extension Set Horizontal (UNIVER-W)

Horizontal Extension of the Vario sliding rod system. The addition of a movable joint opens up many more possibilities to position flash units. Weighs 3.5 oz, 10" length.....CALL



### Extension Set Vertical (UNIVER-W)

Vertical Extension of the Vario sliding rod systems to vary mounting height of flash units. Weighs 3.5 oz, 10" length.....CALL

### Accessories for Flash-Grip and Duo-Flash-Holder

Many other Novoflex accessories lend themselves to be used in conjunction with the flash mounting systems

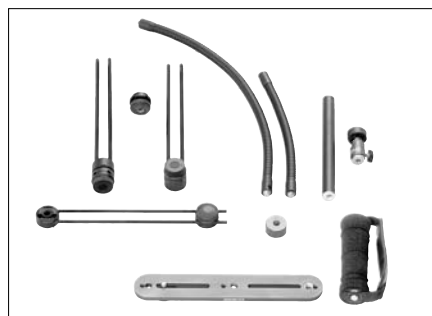

### Flexible Long Arm (UNIMOUNT):

Basic Unit of vario Sliding Rod with 1/4" thread.....CALL

Flexible Arm (NOG177): 18" flexible arm, weighs 16 oz.....57.95

Flexible Arm (NOG102): 12" flexible arm, weighs 10 oz.....52.95

Ball & Socket Head (NOMBFS): With Flash Accessory Shoe .....39.95

### OTHER USEFUL GADGETS FOR FLASH PHOTOGRAPHY



#### Large Clamp for Reflector Panel (NOCRPF):

Clamp with strong spring to hold flat objects, with 1/4" socket .....49.95

#### Mini Clamp for Staset (NOC SX):

A small, strong clamp with a 1/4" socket .....24.95

#### 6 x 8" Screen (MIRROR):

Weighs 7.2 oz .....CALL

#### 6 x 8" Diffusor Screen (OPAK): Weighs 5.3 oz .....CALL

#### Reversible Reflection Screen (NORS812WG):

Reflection screen 8 x 12" white-gold .....26.50

#### Reversible Reflection Screen (NORS812BG):

8 x 12" black-grey .....27.95



### Flash Bracket with Adjustable Rods (NOFBS)

Consists of a sturdy baseplate and two rod sets which have a flexible joint. The joint can turn the rod's second half in four directions, which permits unique angles of flash lighting. These rods can be moved over a length of 8.7". This set includes two small ballheads that have a flash accessory shoe, and the rigidity of the set permits heavy flashes, microphones and video lights to be mounted at all angles. Maximum distance between two flash units is 22". Weighs 32 oz.....224.95

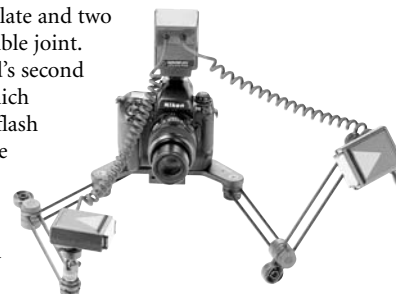

### Flash Bracket with two Flexible Arms (NOFBA2)

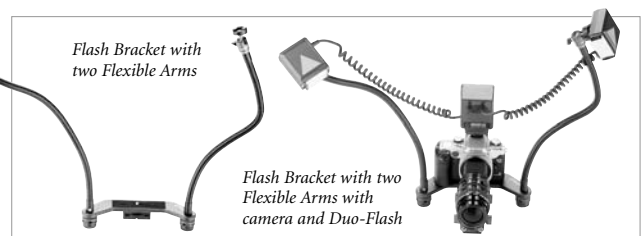

Features the same 9.6 x 3.1 x 1.6" base plate as above, but is equipped with two 19.5" flexible arms with ball and socket heads and flash accessory shoe. Adjusting the position of the flash units is very quick and easy. Weighs 44.5 oz .....224.95

### ACCESSORIES:

**Short Flexible Arm (NOAS):** An 11.6" flexible arm with a 1/4"-20 threaded hole on the bottom and a small ballhead with a flash shoe on top. Strong enough to hold even the heaviest of shoe-mounted flashes securely in position .....64.95

**Flexible Arm (NOA):** Same as above, but with an 18" arm .....69.95

**Base Plate (NOBP):** The foundation for many of Novoflex's flash bracket system of innovative lighting control. Features a wide stable camera platform with two angled edges that accept various arms, ballheads and other accessories with either 1/4"-20 or 3/8"-16 screws. Dimensions are 9.6 x 3.2 x 1.6" .....124.95

### Macro Flash Holder (NOMFH)

Attaches directly to the lens via an optional adapter ring. A great way to control the angle and intensity of dual flash lighting at short distances. Maximum distance of flash from lens is 11.8". Two articulating arms have ballheads with flash shoes at their ends to control the flashes, and the entire assembly folds compactly for storage. 11.4 x 3.5 x 3.1" (WHD), weighs 13 oz.....149.95



# SUNPAK

## FLASH & ACCESSORIES

Sunpak is one of the world's largest manufacturers of electronic flash equipment. Sunpak electronic flashes are designed to work with today's auto focus cameras having dedicated flash capabilities. There's even a Sunpak flash unit available for use with Nikonos underwater camera systems. All Sunpak flash units offer advanced features to provide the widest range of creative control, and are supported by a wide range of system accessories.

### NON-DEDICATED SHOE MOUNT FLASHES

#### 144PC

#### Auto Shoe Mount Flash



Powerful, affordably priced thyristor flash with bounce head, two auto f/stops (f/2, f/5.6) exposure OK lamp and "Instant Readout" exposure control. Use with many cameras to provide light to the subject via direct or bounced flash. Equipped with Sunpak-type off-camera terminal and PC-cord. Weighs 6 oz.

- ◆ Guide No. 66 ◆ Auto Range: 2.3-33'
  - ◆ 3-second recycle time ◆ Uses 4 AA Batteries
- 144PC Flash (SU144PC).....39.95**

#### 383 SUPER

#### Auto Shoe Mount Flash

Popular for years, the 383 Super is a frequent choice for those in need of a powerful, manual undedicated flash in a medium size. Used by enthusiasts and professionals alike, the 383 Super features bounce/swivel head, three auto f/stops (f/2, f/4, f/8) manual control with power ratio from full to 1/16 (5-steps) and exposure OK lamp. With a powerful GN of 120 you can employ the bounce effects more frequently, and the manual scale is easy to use. Weighs 12 oz.



- ◆ Guide No. 120 ◆ Auto Range: 2.3-60'
  - ◆ Equipped with Sunpak-type off-camera terminal and PC-cord
  - ◆ 8.5-second recycle time
  - ◆ Runs on 4 AA batteries or optional NC-510 external battery pack or AD-27 AC adapter
- 383 Super Flash (SU383S) .....69.95**

### DEDICATED/FIXED MOUNT FLASH

#### 144D

#### Multi-Dedicated Shoe Mount Flash



Multi-dedicated thyristor flash with bounce. It is suitable for daylight fill flash and light duty. Switch allows flash to be dedicated with Canon, Nikon, Olympus, Minolta, Ricoh, Chinon, Pentax cameras. Features 2 auto f/stops (f/2, f/5.6) exposure OK lamp, and sets shutter speed and readylight. Weighs 5 oz.

- ◆ Guide No. 66 ◆ Auto Range: 2.3-33'
- ◆ 3-second recycle time ◆ Uses 4 AA batteries

**144D Flash (SU144D).....39.95**

#### 2000DZ

#### Multi-Dedicated Auto Zoom Shoe Mount Flash



Multi-dedicated thyristor flash with bounce, the 2000DZ features 56-80 guide number and 4-position zoom head (can be manually set to cover 35mm, 50mm, 70mm and 135mm focal lengths). Compatible with Canon FD, Nikon, Olympus, Minolta, Ricoh and Pentax cameras. Also features two auto f/stops (f/2, f/5.6) exposure OK lamp, and sets shutter speed and readylight. Weighs 5 oz.

- ◆ Guide No. 56 at 35mm, 66 at 50mm and 80' at 135mm
- ◆ Auto Range: 2.3-28' ◆ 3-second recycle time ◆ Uses 4 AA batteries

**2000DZ Flash (SU2000DZ).....43.50**

#### 355AF

#### TTL Shoe Mount Flash

Great for 35mm AF cameras. A three-position manual zoom head covers 35mm, 50mm and 85mm focal lengths, and the bouncing head offers fulltime TTL dedication with autofocus camera systems.

- ◆ Guide No. 86 at 35mm, 100 at 50mm, 120 at 85mm
- ◆ Focus assist beam on Nikon and Canon cameras
- ◆ 7-second recycle time ◆ Uses 4 AA batteries



**355AF (SU355AFCAF)**  
Auto for Canon EOS .....46.50

**355AF (SU355AFNAF)**  
Auto for Nikon AF.....46.50

**355AF (SU355AFMAF)**  
Auto for Minolta AF.....46.50

**355AF (SU355AFPAF)**  
Auto for Pentax AF.....46.50



For Any Inquiries Regarding Your Order, Call Our Customer Service:  
(800) 221-5743 • (212) 239-7765 • FAX: (800) 947-2215 • (212) 239-7549

# SUNPAK

## DEDICATED/FIXED MOUNT FLASH

### 433D

#### TTL Dedicated Shoe Mount Flash

TTL dedicated flash for Nikon and Minolta with bounce/swivel head. Three auto f/stops (f/2, f/4, f/8), manual control from full to 1/16 power (5 settings).

- ◆ Guide No. 120 ◆ Auto Range: 1.6–60'
- ◆ 7-second recycle time
- ◆ Runs on 4 AA batteries or optional NC-510 external battery pack or AD-27 AC adapter



433D Auto for Minolta TTL (SU433DM).....76.50  
 433D Auto for Nikon TTL (SU433DN).....76.50

### 433AF

#### TTL Dedicated Shoe Mount Flash



Compact autofocus flash with bounce/swivel head, and fulltime dedicated TTL metering for Nikon, Canon and Minolta AF cameras. (3 f/stop auto ranges, manual control with power ratio to 1/16 power for Nikon version only).

- ◆ Focus assist beam on Nikon & Canon cameras
- ◆ Guide No. 86–120 ◆ Use 4 AA batteries
- ◆ 3–position manual zoom (35/50/85mm)

433 AF for Canon (SU433AFCAF).....86.50  
 433 AF for Minolta (SU433AFMAF).....86.50  
 433 AF for Nikon (SU433AFNAF).....6.50

### 444D

#### TTL Dedicated Shoe Mount Flash



A unique flash that accepts Sunpak's complete line of interchangeable dedicated shoe modules. The flash features a detachable 3-position manual zoom (35–15mm) that produces a guide number from 120–170 with ISO 100 film, tilt and swivel control, plus an attached fold-up reflector card for fill-flash capability.

The 3 f/stop (f/2, f/4, f/8) auto range from 1.6–60', and manual control as well as

power ratio down to 1/16 power (5-steps), support creative effects. Power is supplied from 4 AA batteries or from a variety of optional sources, including the TR-PAKIIa nicad power pack or AD-27 AC adapter. Uses the EXT-10 Dedicated Remote Cord for off-camera TTL flash dedication.

- ◆ Guide No. 120 at 50mm
- ◆ Auto Range: 1.6–60' ◆ 12-second recycle time

444D Flash (SU444D).....97.50

### PZ-40X

#### AF TTL Shoe Mount Flash



Available in silver or black, the PZ40X combines high-performance features with innovative design. The unique rounded angles and low-profile provide a more functional design and is the perfect match for current digital and

photo cameras. While compatible with the latest E-TTL (Canon), 3D D-TTL (Nikon) and ADI (Minolta) functions for 35mm digital and film SLR cameras, power-ratio and zoom setting can also be controlled manually in five steps.

- ◆ Even with its smaller size, it has a guide number of 40 (zoom position at 80mm). This greatly extends the distance which can't be covered by any built-in flash and solves under exposure problems.
- ◆ Multi-step auto power zoom with vertical-up 90° bounce. The flash senses focal length and automatically adjusts from 24–80mm.
- ◆ AF Assist light supports better autofocus performance in the dark
- ◆ Compatible with TTL functions of digital and film SLR cameras. Work with TTL Auto, Advanced E-TTL for Canon, 3D Multi-BL and D-TTL for Nikon and ADI for Minolta
- ◆ Choose only the mode you want by simply following the display signs on the large illuminated LCD panel when working with Canon, Nikon or Minolta cameras. For other cameras, Manual Zoom Mode and Power Ratio Mode will give you a big help
- ◆ Power ratio can be manually set in five steps (full, 1/2, 1/4, 1/8 and 1/16)
- ◆ Flash-coverage scale on LCD screen
- ◆ Automatic Shutdown mode after being inactive after 5 minutes
- ◆ Ready lamp (10-second recycle time) and test button
- ◆ 40% smaller in size and 30% lighter than similar flashes, this smaller, lighter configuration allows for easier camera handling

PZ40X (SUPZ40XSNAF): For Nikon AF. Silver color.....124.95

PZ40X (SUPZ40XBNAF): For Nikon AF. Black color.....124.95

PZ40X (SUPZ40XSCAF): For Canon AF. Silver color.....124.95

PZ40X (SUPZ40XBCAF): For Canon AF. Black color.....124.95

PZ40X (SUPZ40XSMAF): For Minolta AF. Silver color.....124.95

PZ40X (SUPZ40XBMAF): For Minolta AF. Black color.....124.95

# SUNPAK

## DEDICATED/FIXED MOUNT FLASH

### MZ-440AF TTL Dedicated Shoe Mount Flash

A TTL flash for 35mm autofocus cameras, the MZ440AF has no manual aperture modes, as it is designed to give full TTL exposure at all apertures. Flash head can be bounced and swiveled for increased lighting control and creative effects. Easy to read display panel has distance readouts in both feet and meters, lens selector setting, ISO selector, flash confirmation light, ready lamp and test button.



- ◆ Guide No. 131 at 50mm, 157 at 85mm
- ◆ Auto Range: 2.3–33'
- ◆ Four detented zoom selector settings (28mm to 85mm), and four detented tilt selector settings (0 to 90°)
- ◆ Includes slide on reflector panel and 20mm ultra wide angle filter
- ◆ 8-second recycle time
- ◆ Uses 4 AA batteries

- MZ-440AF (SUMZ440CAF): For Canon AF .....79.95
- MZ-440AF (SUMZ440NAF): For Nikon AF.....79.95
- MZ-440AF (SUMZ440MAF): For Minolta AF .....79.95
- MZ-440AF (SUMZ440PAF): For Pentax AF.....79.95

### PZ-4000AF Shoe Mount Flash

Available for Nikon, Canon and Minolta the PZ4000AF automatically adjusts the flash to match the focal lengths of lenses from 28mm to 80mm in four distinct settings. If preferred, the zoom head can be manually controlled at the press of a button. For creative bounce lighting control, the head can be adjusted to 90°.



Offers ample power from 4 AA batteries or the optional TR-Pak IIA Power Pack. To conserve battery power, the PZ4000AF goes into a standby mode if not fired after a few minutes (Sleep Mode). Reactivating the flash requires only a slight touch to the shutter release button of the camera to bring the flash back into a readiness mode.

- ◆ Guide No. 24 at 28mm, 40 at 80mm
- ◆ AF Assist Light supports better autofocus performance in the dark
- ◆ Multi-step auto power zoom with vertical-up 90° bounce. The flash senses focal length & adjusts from 24-80mm.
- ◆ Rear-curtain sync
- ◆ All the necessary information and setting value is displayed on LCD display. By pressing the "Light" button, the backlight will illuminate to help you see in the dark.
- ◆ Illuminated LCD panel displays TTL, manual or fill flash modes, second curtain sync for Canon and Nikon versions and flash confirmation

- PZ-4000AF (SU4000ACAF): For Canon AF.....109.95
- PZ-4000AF (SU4000AFNAF): For Nikon AF.....109.95
- PZ-4000AF (SU4000AFMAF): For Minolta AF .....109.95

| Specification Chart                  | 2000DZ           | 355AF                | 433AF            | PZ-40X                 | MZ-440AF             | PZ-4000AF            | PZ-5000AF             |
|--------------------------------------|------------------|----------------------|------------------|------------------------|----------------------|----------------------|-----------------------|
| Guide Number with ISO100 (m/ft)      | 20/66            | 30/98 (50mm)         | 86–120 (80-24mm) | 40-20/130-65 (85-20mm) | 48-16 (80-28mm)      | 40-24 (135-28mm)     | 54-30/177-98          |
| Auto f/stop (ISO100)                 | f2, 4            | —                    | Full TTL         |                        |                      |                      | f2-16                 |
| Alkaline Recycle Time (seconds)      | 3 Sec. (4-AA)    | 3 Sec. (4-AA)        | 8.5 Sec. (4-AA)  | 10 Sec. (2-AA)         | 8 Sec. (4-AA)        | 8 Sec. (4-AA)        | 13 Sec. (4-AA)        |
| NiCad Recycle Time (seconds)         | 2.5 Sec. (4-AA)  | —                    | 8.5 Sec. (4-AA)  | 8 Sec. (2-AA)          | 8 Sec. (4-AA)        | 8 Sec. (4-AA)        | 7 Sec. (4-AA)         |
| TR-Pak II Recycle Time (seconds)     | —                | —                    |                  | —                      | —                    | 1 Sec.               | Approx 2 sec.         |
| AC Adapter Recycle Time (seconds)    | —                | —                    |                  | —                      | —                    | 13 Sec.              | 13 Sec. (AD-27)       |
| Alkaline Number Of Flashes           | 440-2,600        | 150                  |                  | 100                    | 80/500               | 80/500               | 100                   |
| NiCad Number Of Flashes              | 160-1,200        | —                    |                  | 45                     | 80/500               | 80/500               | 45                    |
| TR-Pak II Number Of Flashes          | —                | —                    |                  | 300                    | 350-                 | 400-1,200            | 350                   |
| Bounce Flash (Vertical / Horizontal) | Vertical         | Vertical             | V & H            | Vertical               | V & H                | V & H                | V & H                 |
| Angle Of Coverage (35mm Format)      | 70° (32mm)       | 63° to 28° (35-85mm) | 63° (35mm)       | 84°-30° (24-85mm)      | 75° to 28° (28-85mm) | 75° to 31° (28-80mm) | 78° to 18° (28-135mm) |
| Flash Speed (Approx. sec.)           | 1/1,600-1/25,000 | 1/500-1/30,000       |                  | 1/500-1/13,000         | 1/1,000-1/20,000     | 1/500-1/20,000       | 1/500-1/30,000        |
| Weight w/o Batteries                 | 6.2 oz           | 8.1 oz               | 11.04 oz         | 7.1 oz                 | 12.7 oz              | 9.5 oz               | 13 oz                 |
| Dimensions w/o Shoe (HxWxD)          | 3.8 x 2.7 x 3.6" | 3.7 x 2.8 x 3"       | 3 x 5.7 x 2.8"   | 3.7 x 2.5 x 3.6"       | 7 x 3.1 x 2.3"       | 4.9 x 2.8 x 4"       | 5.4 x 3.4 x 4.2"      |



**EQUIPMENT LEASING AVAILABLE**

# SUNPAK

## DEDICATED/FIXED MOUNT FLASH

### PZ-5000AF

#### AF TTL

#### Shoe Mount Flash



Designed for conventional Canon, Nikon, Minolta and Pentax AF SLRs, the PZ5000AF is a large (13 oz), high-powered unit with a Guide No. of 180 (in feet, at ISO 100 at the 135mm setting) and

includes an auto zoom (and manual zoom) head with settings from 28-135mm.

#### Offers all of the essential features:

- ◆ TTL auto sensor, power ratio options, Auto flash with many aperture choices, manual flash operation, and "stroboscopic" flash.
  - ◆ Supports rear curtain flash, and off-camera slaved flash for wireless non-TTL flash; with Minolta cameras, wireless off-camera flash is TTL controlled.
  - ◆ ISO setting: 6-6400 (1/3 EV steps)
  - ◆ Flash control modes:
    - 3D Multi-BL for Nikon
    - ADI Metering for Minolta
    - TTL Auto Mode
    - Flash Auto Mode (7-step auto exposure) f2 -to - f16 (1/3 EV step)
    - Variable Power Ratio (7 steps): Full- to 1/64 (1/3 EV steps)
    - Multi (Stroboscopic) Flash: 1Hz - 90Hz
  - ◆ Information and settings are displayed on the large, illuminated LCD display.
  - ◆ Goes into a standby mode if not fired after a few minutes (Sleep Mode).
  - ◆ AF Assist Light supports better autofocus performance in the dark
  - ◆ Wireless TTL capability when combined with other PZ-5000 AFs
  - ◆ Bounce flash head movement: Vertical up 90°/down 5°; Horizontal left 180°/right 90°
- PZ-5000AF (SU5000NAF):** For Nikon.....**147.50**  
**PZ-5000AF (SU5000CAF):** For Canon.....**147.50**  
**PZ-5000AF (SU5000MAF):** For Minolta...**147.50**  
**PZ-5000AF (SU5000PAF):** For Pentax.....**147.50**

### 120J/120JTTL Parabolic Reflector Flashes



The 120JTTL is a parabolic reflector flash that offers through-the-lens flash dedication capability with popular 35mm and medium format cameras. Able to accept the complete line of Sunpak dedicated modules, the 120JTTL is extremely compact, lightweight and easy to operate, yet it produces an impressive guide number of 45/150 (m/ft) with ISO 100 film. Both tilt and swivel movements are provided. When combined with the optional EXT-10 Cord, it permits the 120JTTL to be used off-camera, yet still maintain complete dedicated flash capability.

The flash is powered by the high voltage TR-PAKIIa nicad power pack, which provides 200 full-power flashes at an impressive 1.5-sec. recycle rate or AC adapter. The 120J TTL can also run on 4 AA batteries, when greater capacity or faster recycling isn't needed.

When TTL flash dedication is either not available or desired, the 120JTTL and its identical non-TTL version the 120J offer three aperture settings, plus manual adjustment (full, 1/2, 1/4, 1/8, 1/16 power) for total creative control. The parabolic reflector can be positioned for normal and wide angle use, or removed for bare bulb lighting that creates a uniquely natural lighting effect.

**120J Auto Bracket/Light Stand Mount Flash (SU120J)** .....**169.95**

**120J Flash Kit (SU120JBP):**  
With TR-PAK IIA Battery Pack and CHG-20 Charger .....**259.95**

**120JTTL Shoe Mount Flash (SU120JTTL):**  
Requires module .....**209.95**

**120JTTL Flash Kit (SU120JTTLBP):**  
With TR-PAK IIA Battery Pack and CHG-20 Charger. Requires module.....**299.95**

### Modules & Cords

Sunpak's DX Series can be attached to most SLR AF cameras and some medium format cameras which have TTL functions. As the battery is fully charged for the first time, shutter speed will automatically set for the optimum speed. You can choose P, AV or TV mode. DX Series also feature Sunpak's unique "Exchange Shoe Mount". An interchangeable "DX shoe" is used for the six different DX series flash models, and it can be used with various cameras by changing the DX shoe.



|  |              |
|--|--------------|
| <b>BR-1D</b> Bronica Dedicated Module for ETRSi and SQAi (SUDMB).....          | <b>84.95</b> |
| <b>CA1AF</b> Canon Dedicated Module for EOS w/Focus Assist Beam (SUDMCAF)..... | <b>74.95</b> |
| <b>HA2D</b> Hasselblad Dedicated Module (SUDMH).....                           | <b>69.95</b> |
| <b>MX1AF</b> Minolta TTL AF Dedicated Module (SUDMMAF).....                    | <b>74.95</b> |
| <b>MX2D</b> Minolta TTL Dedicated Module (SUDMM).....                          | <b>31.95</b> |
| <b>NE1AF</b> Nikon TTL Dedicated Module w/Focus Assist (SUDMNAF).....          | <b>74.95</b> |
| <b>NE2D</b> Nikon TTL Dedicated Module w/o Focus Assist (SUDMN).....           | <b>31.95</b> |
| <b>NE3D</b> Nikon TTL Dedicated Module for F3 (SUDMNF3).....                   | <b>44.95</b> |
| <b>STD1D</b> Standard Dedicated Module with PC Sync Cord (SUDMS).....          | <b>21.95</b> |
| <b>EXT-9</b> Dedicated Remote Cord for non-TTL Canon & T90 (SUEXT9).....       | <b>39.95</b> |
| <b>EXT-10</b> Dedicated Remote Cord for all Cameras plus EOS (SUEXT10).....    | <b>39.95</b> |
| <b>EXT-11</b> Dedicated Remote Cord for 522 and 622 (SUEXT11).....             | <b>39.95</b> |

# SUNPAK

## HANDLE MOUNT FLASHES

### AUTO 544 Handle Mount Flash

The Auto 544 is the flash chosen by those professionals needing only auto and manual flash control. The 544 has tilt and swivel capability and delivers a powerful 140 guide number (ISO100). Featuring auto thyristor circuitry that provides a 4 f/stop aperture range and auto coverage from 1.6 to 50', the 544 includes power ratio control from full to 1/64 power yet weighs only 25 ounces (without batteries). Accepts a number of power sources, including the CL-2 Nicad Cluster, the high voltage TR-PAKIIa Nicad power pack or an AC adapter.

**544 Auto Handle Mount Flash (SU544):**

With 2' PC cord, camera bracket, AA battery holder and filter holder .....129.95

### AUTO 555 Handle Mount Flash

A powerful, professional handle mount flash with TTL flash dedication capability (requires EXT-11 Cord, and appropriate dedicated module). The Auto 555 features bounce and swivel control for creative lighting effects. A guide number of 150 with ISO 100 film assures ample power. Auto range extends from 1.6 to 107', over a 7 aperture range. In addition to TTL and auto capability, the 555 features manual flash control from full to 1/64 power. The 555 accepts a number of power sources, including the CL-2 Nicad Cluster, the high voltage TR-PAKIIa Nicad power pack or an AC adapter.

**555 TTL Handle Mount Flash (SU555):**

With 2' PC cord, camera bracket, clamp, AA battery holder and filter holder .....169.95

### 622 SUPER PRO Handle Mount Flash

The most powerful handle mount dedicated flash system. Features the ability to use any of 7 interchangeable flash heads (standard, wide angle, zoom, infrared, ringlight, diffused and bare bulb) as well as a wide range of autofocus & TTL dedicated modules. Requires use of EXT-11 Cord, and appropriate Sunpak dedicated module. Has seven auto aperture settings, as well as manual control with power ratio from full to 1/128th power. Able to operate from a variety of power sources, including AC, its boasts an impressive guide number of 60/200 (m/ft) with ISO 100 film. Accepts the TR2000 high voltage battery pack.

**622 Super Pro TTL Handle Mount Flash (Without Head) (SU622S):**

With CG-10 battery cartridge, 10" PC cord and camera bracket .....269.95



### 622 SUPER PRO System Accessories

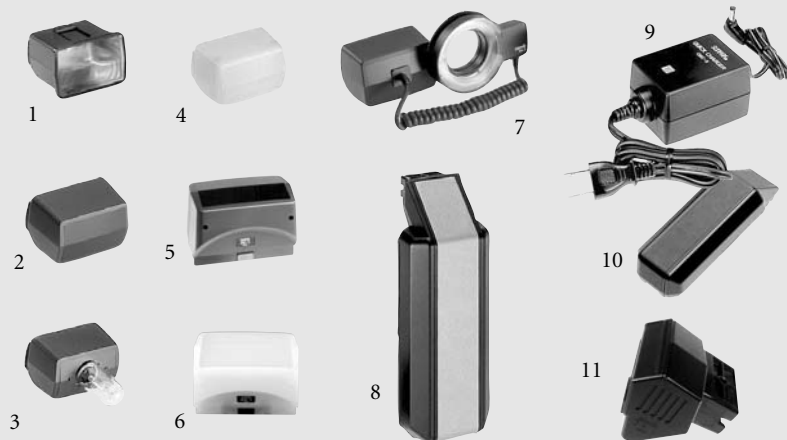

- 1) Standard (35mm) Flash Head (SUFHS622) .....38.75
- 2) Zoom Flash Head (SUFHZ622) .....49.95
- 3) Bare Bulb Flash Head (SUFHBB622) .....94.95
- 4) Wide Angle Flash Head (SUFHW622) .....36.95
- 5) Infra-Red Flash Head (SUFHI) .....44.95
- 6) Diffused Flash Head (SUFHD622) .....39.95
- 7) Ringlight Flash Head (SUFHRL622) .....79.95
- 8) CG-10 Battery Cartridge (SUCCG10):  
Holds 4 nicad or alkaline "C" size batteries .....28.95
- 9) QBC-6 Quick Charger (SUQBC6): .....64.95
- 10) CL-3 Nicad Battery C3luster (SUCL3): .....64.95
- 11) CV-1 Conversion Plug (SUCCP):  
When using power sources other than batteries, insert CV-1 to the connecting jack of the body, then connect with power source .....12.50

## RINGLIGHT & UNDERWATER FLASHES

### D-Macro/DX-12R

#### TTL Macro Ringlight Flashes

The D-Macro and DX-12R are dedicated ringlight flashes that provide even, shadow-free light for medical, industrial or creative applications. They accept the full range of Sunpak dedicated modules and both offer power ratio control over a 5 f/stop range.



#### D-Macro

For 58mm and smaller diameter lenses, the Dmacro provides full exposure accuracy for every camera system you have just by changing

the dedicated module. This enables macro shots of subjects in variable light, because the complexities of macro exposure are easily handled by the TTL measurement. Offers a guide number of 26 with ISO 100 film.

- ◆ Ringlight flash for 49mm- to-58mm filter sizes
- ◆ TTL, auto and manual control
- ◆ Power ratio—full to 1/64th power
- ◆ Accepts TTL and dedicated modules
- ◆ Has ultra-diffused Opal lens

**D-Macro (SUDMACRO)**  
With STD-1D module .....CALL

#### DX-12R

The DX-12R is designed to work with 35mm and medium format systems having filter diameters up to 77mm. In addition to its impressive guide



number of 40 with ISO 100 film, the DX-12R has four built-in modeling lamps to assist in focusing. These automatically turn off when the flash is fired.

- ◆ The only TTL dedicated ringlight flash for use on 35mm and medium format camera lenses with filter diameters up to 77mm
- ◆ 4 focusing lamps provide focus assistance in low light
- ◆ Accepts TTL and dedicated modules

**DX-12R (SUDX12R):** Requires module .....229.95

### G-Flash

#### All Weather/Underwater Strobe

The G-Flash isn't just weather-resistant—it's submersible down to 148 feet. This makes it perfect for scuba divers, snorkelers, skiers, construction engineers—anybody who needs to take pictures in an environment where dust, sand, snow, rain or

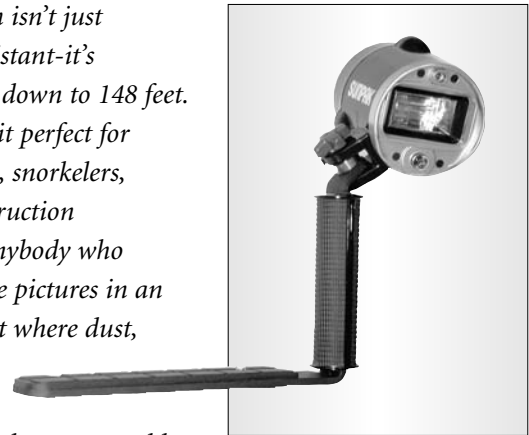

other harsh elements would destroy an ordinary flash. Thanks to its robust, impact-resistant body, high performance, and user-friendly controls, the Sunpak G-Flash makes it easy for anyone to take great flash pictures under adverse conditions.

- ◆ The G-flash packs a powerful punch. Its ISO 100 guide number 70 gives perfect exposures with subjects at extended distances, and lets you use smaller apertures for increased depth of field.
- ◆ Sensitive built-in slave provides reliable performance even with bounce flash or distant triggering flash. No extra wires or connections needed.
- ◆ The flash is continuously adjustable. By turning a simple rotary dial you can set the output for flash guide numbers from 10-70.
- ◆ Compatible with any underwater, weather-resistant, or standard digital or film camera with a built-in flash and a standard 1/4 x 20" tripod socket. It can also be used with most flash-equipped cameras in underwater housings or protective weather shields
- ◆ The G-Flash is easy to install with attached right-angle bracket and built-in handgrip and actually improves the handling of many underwater cameras.
- ◆ Pre-flash setting on the main control dial, provides reliable sync with cameras using pre-flash for autoflash or distance confirmation.
- ◆ The G-Flash covers a wide angle. It illuminates the 28mm lens field on a 35mm camera with no noticeable light falloff, and with included wide-angle panel, will cover ultrawide-angle lenses down to 20mm.
- ◆ Powered by two AA batteries (alkaline, nicad, or NiMH), it recycles in just 9 sec. with alkaline cells and 7.5 sec with NiMH. A set of alkalines provide about 150 flashes, NiMH batteries about 230. Measures 2.7 x 2.7 x 4.1" (main body) and weighs 16 oz. (with bracket, without batteries).

**G-Flash (SU067G):** Includes bracket, wide adapter/diffuser .....179.50

# SUNPAK

## FLASH ACCESSORIES

### Battery Packs, Chargers and AC Adapters

#### TR-2000 High Voltage Battery Pack

A universal high-voltage battery pack, the TR2000 is a flexible power source for both high and low-voltage flashes, including non-Sunpak brands. Whether you need 6 or 330v, you have it with the TR2000. Compatible with the full range of Quantum Turbo (HV) or Battery 1+ (LV) flash modules.

Continuous, unlimited power is possible simply by swapping interchangeable nicad power clusters. A power status indicator lets you know when to insert a fresh battery cluster, and Memory-Free technology ensures you have 100% capacity every time. Only 24 ounces, and a compact 5 x 6 x 2.5" with battery cluster. Shoulder strap and battery charger included.

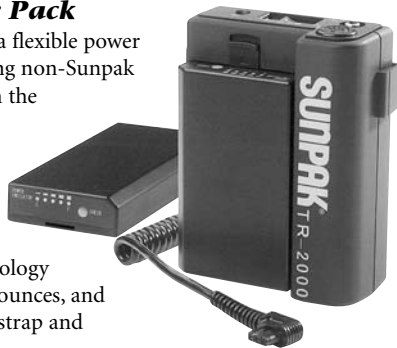

- ◆ 270 full power manual shots, and 1000+ automatic shots per charge
- ◆ Ergonomically contoured design with tough, non-slip rubberized surface
- ◆ Microprocessor control for safe, reliable operation, provides regulated high and low voltage outputs
- ◆ Works with fast, snap-in nicad or ultra high capacity 3000mAh "memory-free" NiMH battery cluster
- ◆ On-demand power status with or without battery mounted on power pack
- ◆ Rechargeable up to 1000 times

- TR-2000 High Voltage Battery Pack Kit (SUTR2000):** Includes battery pack, nicad cluster, AC charger and strap. (Requires MC series connector cord) .....**249.95**
- 2400mAh Nicad Battery for TR-2000 (SUNB2000):** Replacement .....**67.50**
- 3000mAh NiMH Battery for TR-2000: (SUNIMHB2000)** .....**89.95**
- MC-3023: 10' 2-Pin High-Voltage Connector Cord for TR-2000: (SU2PCFS)** .....**19.95**
- MC-3024: 10' 3-Pin High-Voltage Connector Cord for TR-2000: (SU3PCFS)** .....**19.95**
- MC-3025 10' 3-Pin High-Voltage Connector Cord (PZ-Series) for TR-2000: (SU3PCPZ)** .....**19.95**



#### TR-PakIIa

#### Battery Pack with Charger

A high performance battery pack, the TR-PakIIa provides the fastest recycling and most number of flashes of any portable pack. Compatible with

the 120J/TTL, DX-8R/12R, 433D/AF, 3600D/AF, 444D, 3600DX, PZ4000/5000, 544, 555 and 622 Super Pro (622 requires CV-1 conversion plug #1168). Includes shoulder strap and 8-hour charger (SUTRP2A) .....**89.95**

**CL-Pak II Battery for TR-Pak IIa Pack (SUBTRP2A)** .....**59.95**

#### 510v Power Pack and 510v Rechargeable Nicad Battery

Compatible with the 383 Super, PZ4000AF, PZ5000AF, Auto 544/555, 622 Super Pro, 120JTTL, DX-8R and DX-12R.

- 510v Power Pack (SUPP510)** .....**69.95**  
**510v Nicad Battery Pack (SUBN510)** .....**79.95**

#### CL-2 Nicad Battery Cluster (SUCL2)

For use with Auto 522/544/555, the CL-2 provides up to 400 flashes (depending on usage) when fully charged. Recharges in 3 hours via the QBC-5 Quick Charger .....**34.95**

**QBC-5 Quick Charger (SUQBC5):** For CL-2 and NC-510 batteries .....**31.95**



#### QB-3 (SUQB3)

Set of 4 AA nicad batteries .....**33.95**

#### QBC-3 Quick Charger (SUQBC3)

3-hour quick charger for QB-3 nicad batteries .....**66.95**

#### AD-26 100-240v, 50/60Hz AC Adapter (SUAD26)

For use with the 544, 555, 611 and 622 Handle Mount Flashes .....**31.95**

#### AD-27 100-240v, 50/60Hz AC Adapter (SUAD27)

For use with the 383 Super, 422D, 433D+AF, 444D, DX-8R, DX-12R and 120J/TTL .....**31.95**

### Miscellaneous Accessories

#### Bounce Lighting Kit (SUBLK):

Designed for pleasant soft, indirect lighting effects .....**24.95**

**Basic Grip (SUG):** Designed for hot shoe flashes, the Basic Grip features a built-in hot shoe, contoured grip, tripod socket and includes a 35mm Sunpak 12-position bracket .....**41.95**

#### 6x6 Bracket (SUB66):

Medium format bracket base for 522, 544, 555, 611, 622 and Basic Grip .....**CALL**



**EQUIPMENT LEASING AVAILABLE**



# SUNPAK

## FLASH ACCESSORIES

### Tele Kits

Ideal for use with telephoto and zoom lenses of the most popular focal lengths, the Tele Kits actually increase light intensity while decreasing the angle of illumination.

- TL-3 (SUTL3)**  
Tele Kit for 522, 544, 555 .....**32.50**
- TL-6 (SUTL6)**  
Tele Kit for 422D .....**27.95**

### Filter Kits

Red, blue, green, yellow, ND, UV and 85B filters are supplied in a carrying case with two wide angle diffusers.

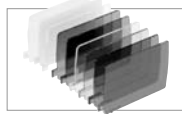

- FK-1 Filter Kit (SUFK1)**  
For 2000DZ, 383, 444D, 433D/AF .....**24.95**
- FK-2 Filter Kit (SUFK2)**  
For 522, 544, 555, 611 .....**24.95**
- FK-6 Filter Kit (SUFK6)**  
For 622 Zoom Head.....**29.95**

### Diffusion Filters

Provides increased angles of coverage for 20mm and 28mm lenses:

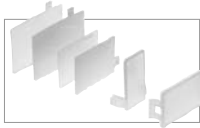

- 20mm Diffusion Filter (SUD20544)**  
For 522, 544 & 555 .....**8.50**
- 28mm Diffusion Filter (SUD28544)**  
For 522, 544 & 555 .....**8.50**

### Filter Holder

Permits you to attach the filter kit onto the front of the flash.



- FH-11 Filter Holder (SUFH522)**  
For 522, 544, 555 .....**12.50**
- FH-12 Filter Holder (SUFH444)**  
For 383 Super, 422D, 433D/AF, 444D .....**12.95**

### Extension Cords

PC male to PC female extension cords which permit you to operate the flash unit away from the camera.



- 3' Extension PC Cord (SUPCE3)** .....**9.50**
- 10' Extension PC Cord (SUPCE10)** .....**9.95**
- 15' Extension PC Cord (SUPCE15)** .....**9.95**

## DigitFLASH 500/1000

The DigitFlash 500 and DigitFlash 1000 are 500 w/s and 1000 w/s flat panel flashes with a dimmable fluorescent modeling light. The power of the flashes range from full to 1/32 power. These unique flashes provide soft, even illumination for 3/4 length portraits or medium size product shots, eliminating the need for a softbox, and takes up a fraction of the space of a conventional strobe with softbox.



- ◆ Quiet, and cool-running, with long-life linear flash tubes and flicker-free fluorescent modeling light.
- ◆ Portable and lightweight.
- ◆ Dual sensitive slaves ensure synchronization with other strobes.
- ◆ Rear control panel offers full control over flash and modeling light output.

- DigitFlash 500 (SUMDF500)** .....**494.95**
- DigitFlash 1000 (SUMDF1000)** .....**659.95**

## DigitLITE 600

The DigitLite 600 is a fluorescent light panel that provides daylight-balanced, flicker-free constant light. It is suitable for use with digital or film cameras, and is less than 3" thick. The 5600° K light output is very soft, coming from 6- 24 watt tubes. The electronic ballast offers full adjustment of power level.

- ◆ Soft, uniform, diffused light.
- ◆ Low power consumption.
- ◆ This size is suitable for a head-and-shoulders portrait, or small product setup.

- DigitFlash 600 (SUMDL600)** .....**374.95**

## FP-38 Flat Panel Flash

The slim FP-38 is less than one 1" thick and weighs only 9.8 ounces. It mounts onto any camera using the supplied "Hot Shoe" mounting bracket. It can also be mounted using the optional "L" shaped handgrip or the Mini Tripod with Extension Arm. Two FP 38 units can be mounted together on one Hot Shoe bracket and can be simultaneously fired with the built-in slave feature.



- ◆ Can be mounted horizontally or vertically.
- ◆ Large, diffused surface area creates a soft box effect.
- ◆ Powered by 4AA batteries or the Sunpak Universal AC Adapter Kit (ACC-M1035-01)

- FP-38 Flat Panel Flash Kit (SUPP38):** Includes sync cord and 4 AA batteries .....**74.95**
- Flash Grip and Extension Arm (SUMCEFFGEA)** .....**44.95**

# VIVITAR

## DEDICATED & NON-DEDICATED FLASHES

### 16M/16A

#### Manual/Automatic Flashes



Ideal for travel or basic photography, the 16A (automatic), or 16M (manual) flashes feature a hot shoe and PC cord, GN of 52 (ISO 100/ft.), and an easy-to-use calculator chart. They also have a flash test button and flash ready indicator.

- 16M Manual Flash (VI16M) .....12.95
- 16A Auto Flash (VI16A).....14.95

### 2000

#### Auto Flash with Bounce

Ideal for travel or basic photography or as a second flash unit, provides an auto flash range to 28' (with f/2.8 lens at ISO 100/ft.)



- ◆ Hot shoe and PC cord
- ◆ Flash test button and flash ready indicator

- ◆ Permanently secured hinged battery compartment cover
- ◆ Easy-to-use calculator chart

2000 Auto Flash (VI2000) .....19.95

### 2800

#### Auto Flash with Bounce



- ◆ Guide number 80 (ISO 100/ft.) for auto flash range to 40'
- ◆ Four position bounce head for soft, even lighting
- ◆ Unique control panel for ease-of-use

- ◆ Delivers 450-3000 flashes per set of AA batteries. Recycles in .5 to 5 seconds
- ◆ Includes a wide angle filter for lens coverage to 35mm, and a color filter kit (red, green, blue and yellow filters)
- ◆ Auto Thyristor circuitry for faster recycle time and longer battery life

2800 Auto Flash (VI2800) .....34.95

### 560D

#### Dedicated Shoe Mount Flash for Manual Focus Cameras

Ideal for travel or basic photography or as a second flash unit, the 560D has a GN of 80 (ISO100/ft.), provides an auto flash range to 33' (f/2.8 lens using ISO 100 film) and is dedicated to manual focus 35mm SLRs including Canon, Minolta, Nikon and Pentax. It features a manual zoom head for telephoto and wide angle adjustable coverage as well as a flash test button and flash ready indicator. It also incorporates auto off circuitry that turns the flash off when not in use and an easy-to-use calculator chart.



560D Dedicated Shoe Mount Flash (VI560DF): For Canon, Nikon, Minolta and Pentax manual focus cameras .....39.95

### 728AF

#### Zoom Flash for SLR Autofocus Cameras



The 728AF flash head manually zooms to match 35mm, 50mm or 85mm focal lengths, while the 7-position (0-90°) vertical bounce flash provides softer, more professional quality lighting. Other features include automatic operation for easy flash photography, Auto Thyristor circuitry for fast recycle time and long battery life, auto check confirmation and flash ready indicator, and an easy-to-use sliding calculator scale. GN is 92 (ISO 100/ft.).

728AF Zoom Flash: For Canon EOS (VI728AFCAF), Minolta Maxxum (VI728AFMAF), Nikon AF (VI728AFNAF), and Pentax AF (VI728AFPAP) .....42.95

### 730AF

#### Zoom Flash for SLR Autofocus Cameras

Stepping up from the 728AF, the 730AF features full TTL operation with a host of camera systems, so you are assured of accurate exposure in most situations. And with Infrared autofocus assistance, the 730AF can actually help the camera achieve focus when operating in low light and low contrast scenarios. In addition, the flash head manually zooms to match 28mm, 35mm, 50mm or 85mm focal lengths—and swivels (150° right, 180° left). Also offers variable high or low power. GN is 92 (ISO 100/ft.).

730AF Zoom Flash: For Canon EOS (VI730AFCAF), Minolta Maxxum (VI730AFMAF), Nikon AF (VI730AFNAF), and Pentax AF (VI730AFPAP) .....64.95



### 850AF

#### Power Zoom Flash for SLR Autofocus Cameras



The 850AF is Vivitar's flagship autofocus unit, equipped with features normally only with expensive professional units. It steps up from the 730AF with a power zoom to match 28mm, 35mm, 50mm or 85mm focal lengths (as well as manual control), 4-setting power ratio (full, 1/2, 1/4, 1/8) and first or second curtain flash sync. For convenience it goes into standby mode after 3 minutes and has a permanently secured hinged battery compartment cover. Like the 730AF it offers full TTL operation with a host of camera systems, so you are assured of accurate exposure in most situations, and with Infrared autofocus assistance, can actually help the camera achieve focus when operating in low light and low contrast scenarios. GN is 120 (ISO 100/ft.).

850AF Zoom Flash: For Canon EOS (VI850AFCAF), Minolta Maxxum (VI850AFMAF), and Nikon AF (VI850AFNAF) .....124.95

# VIVITAR

## DEDICATED & NON-DEDICATED FLASHES

### 283

#### Professional Auto Shoe Mount Flash

The most popular electronic flash unit in the history of 35mm photography. The 283 is durable and powerful, yet simple and inexpensive.

- ◆ Guide number 120 (ISO 100/ft.), powerful automatic exposure range from 3- to 43'
- ◆ 4 auto f-stop settings for controlling depth-of-field and maximum auto flash range.
- ◆ Vertical bounce flash (45°, 60°, 75°, 90°) for softer, professional quality lighting.
- ◆ Removable flash sensor can be camera mounted with the optional SC-1 (straight) or SC-2 (coiled) sensor extension cords, allowing automatic exposure when using side bounce flash photography.
- ◆ Optional VP-1 variable power control for convenient fill flash and rapid sequence photography.
- ◆ Auto Thyristor circuitry for faster recycle time and greater number of flashes.



VI283 \$69<sup>95</sup>

VI285HV \$84<sup>95</sup>

### 285HV

#### Professional Auto Shoe Mount Flash

Stepping up from the 283, the 285HV accepts optional high voltage power sources, is equipped with a 3-position zoom flash head, and has built-in vari-power control.

#### Same features as the 283 PLUS—

- ◆ Guide number 120 (ISO 100/ft.), powerful automatic exposure range from 3- to 70'.
- ◆ Powered by 4 AA batteries, 510v battery, NC-3 nicads, or SB-4 AC adapter.
- ◆ Three-position zoom flash head (35mm, 50mm and 105mm)
- ◆ Vertical bounce flash (0°, 45°, 60°, 90°) for softer lighting.
- ◆ Removable flash sensor can be camera mounted with the optional SC-3 sensor cord, allowing automatic exposure when using side bounce flash photography.
- ◆ Built-in vari-power (1/2, 1/4, 1/16) for convenient fill flash and rapid sequence photography.

| Vivitar                       | 560D                | 728AF          | 730AF                 | 850AF             | 283              | 285HV                |
|-------------------------------|---------------------|----------------|-----------------------|-------------------|------------------|----------------------|
| Guide Number ISO @ 100 ft.    | 55-90               | 92             | 115                   | 120               | 120              | 120 (50mm)           |
| Angle of Coverage (35mm)      | 28/35/50/85mm       | 35/50/85mm     | 28/35/50/85mm         | 28/35/50/85mm     | 35mm             | 28/35/50/105mm       |
| TTL Mode                      | Yes                 | Yes            | Yes                   | With All Configs. | No               | No                   |
| Bounce Adjustment             | 0-90°               | 0-90°          | 0-90°                 | 0-90°             | 0/45/60/90°      | 0/45/60/90°          |
| Swivel Head                   | —                   | —              | 150° right, 180° left | 0-330°            | —                | —                    |
| Recycling Time: (Manual/Auto) | 6 sec. / 0.5-6 sec. | 5 sec.         | 8 sec.                | .5 - 8 sec.       | 11 sec           | 10.4 sec. (Alkaline) |
| Power Source                  | 4AA                 | 4AA            | 4AA                   | 4AA               | 4AA, NC-3 NiCad  | 4AA, NC-3 NiCad      |
| Weight                        | 9.9 oz.             | 7.0 oz.        | 7.0 oz.               | 13.59 oz.         | 13.5 oz.         | 14.oz.               |
| Dimensions (HxWxD)            | 6.8 x 2.7 x 1.6"    | 4.5 x 2.7 x 3" | 7.3 x 2.9 x 1.9"      | 5.4 x 2.6 x 1.9"  | 4.9 x 3.7 x 3.7" | 4 x 5.2 x 4.2"       |



### 5000

#### Macro Ring Flash

Ideal for photographing insects, stamps, coins or other intricate objects at close range. Offers a choice of manual or automatic operation. Auto exposure range of 1.0 to 31'.

- ◆ Two AA alkaline batteries provide 120 flashes with 10-second recycling
- ◆ Auto-off circuitry prolongs battery life.
- ◆ Comes complete with PC cord and 49mm, 52mm and 55mm adapter rings.
- ◆ Orange flash ready light and convenient flash test button.

5000 Macro Ring Flash (VI5000) .....89.95

### 6000AF TTL Autofocus Macro Ring Flash



When shooting at extremely short distances, relatively minor movement of lighting and subject results in relatively large changes of exposure. Shooting quick-moving subjects in rapidly changing conditions becomes an exercise in dependency on film latitude. Designed for Nikon, Canon, Minolta and Pentax AF

cameras, the 6000AF features TTL operation allowing accurate exposures of closeup subjects. TTL metering eliminates the need for lengthy calculations of exposure, because the inherent loss of light at macro distances can automatically be accounted with ease.

- ◆ Provides an auto range up to 10'
- ◆ Flash test button and flash ready indicator

6000AF TTL Autofocus Macro Ring Flash: For Canon EOS (VI6000CAF), Minolta Maxxum (VI6000MAF), Nikon AF (VI6000NAF), and Pentax AF (VI6000PAF).....99.95

# VIVITAR

## FLASH ACCESSORIES

FLASHES & ACCESSORIES

244

### SC-1 Sensor Cord

4' cord connects the 283's flash remote sensor to the flash for off-camera automatic flash photography.

SC-1 Sensor Cord (VISC1) .....29.95

### SC-2 Sensor Cord

6.5' coiled cord connects the 283's flash remote sensor to the flash for off-camera automatic flash photography.

SC-2 Sensor Cord (VISC2) .....34.95

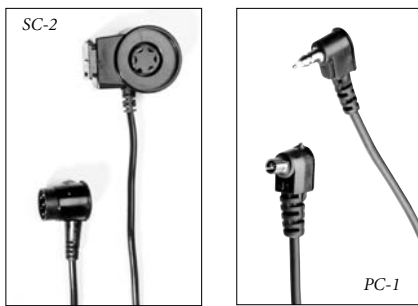

### SC-3 Sensor Cord

4' coiled cord connects the 285 and 285HV's flash remote sensor to the flash for off-camera automatic flash photography.

SC-3 Sensor Cord (VISC3) .....34.95

### PC-1 Sync Cord

1' cord connects the 283, 285HV to the camera's PC contact for off-camera flash operation.

PC-1 Sync Cord (VIP3) .....8.95

### PC-31 Sync Cord

3.3' coiled cord connects the 283, 285HV to the camera's PC contact for off-camera flash operation.

PC-31 Sync Cord (VIP31) .....14.95

### NC-3 NiCad Battery

For the 283, 285HV, and Series 1 600 flash units, the NC-3 is a four-cell nicad battery that produces faster recycling time than disposable alkaline batteries. Provides approximately 45 manual full power flashes.

NC-3 NiCad Battery (VIN3) .....CALL

### AP-1 Battery Holder

Retains 4 AA alkaline batteries inside battery compartment of flash units and pistol grip. Replacement for the original battery holder.

AP-1 Battery Holder (VIAP1) .....8.95

### FK-1 Flash Filter Kit

For the 283, kit includes ND4, 85B, UV, Red, Blue, and Yellow filters, and a pouch. Requires FA-1 adapter.

FK-1 Flash Filter Kit (VIFK1) .....14.95

### WFK-1 Flash Filter Kit

Includes red, blue, yellow, 85B, ND4, UV and clear wide angle diffuser. Requires the FA-1 adapter. Includes a filter pouch.

WFK-1 Flash Filter Kit (VIWFK1) .....14.95

### LK-1 Flash Lens Kit

For the 283, includes four lenses (24mm, 28mm, 70mm, and 135mm) and pouch. Requires FA-1 adapter.

LK-1 Flash Lens Kit (VILK1) .....22.95

### FA-1 Filter Adapter

This filter adapter allows use of FK-1 and WFK-1 filters and LK-1 flash lens kit on the 283 Flash.

FA-1 Filter Adapter (VIFA1) .....12.95

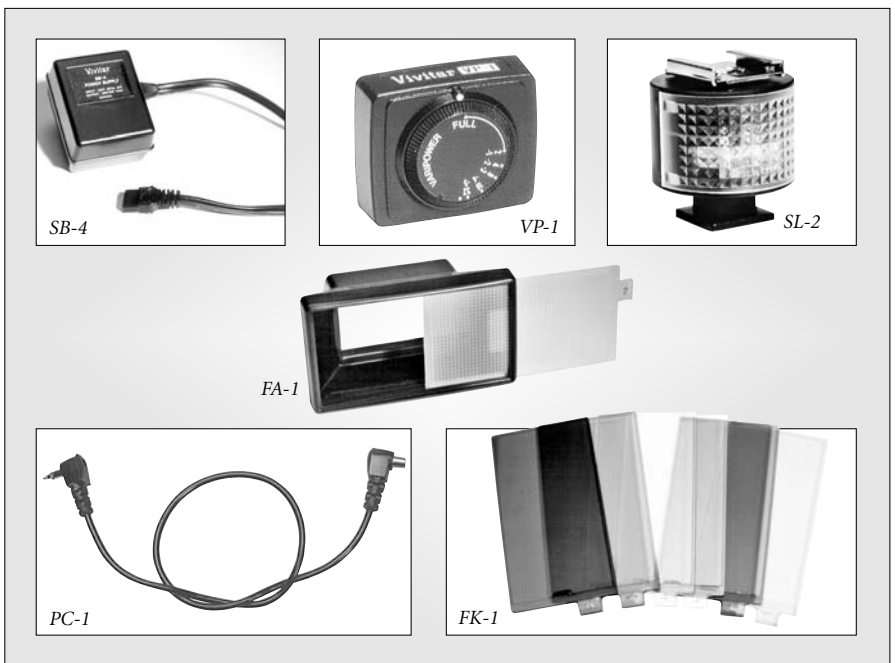

### VP-1 Vari-Power Adapter

Interchangeable with 283's standard sensor to permit variable light output. Continuous adjustment settings for 1/64, 1/32, 1/16, 1/8, 1/4, 1/2, and full power. As power is reduced, flash duration is shortened to as little as 1/30,000 second for freezing fast action.

VP-1 Vari-Power Adapter (VIVP1) .....29.95

### SL-2 Remote Flash Trigger

Used for remote cordless firing of off-camera flash. Ideal for multiple lighting portrait set-ups. Mounts to camera's flash shoe, light stand, or tripod with 1/4-20 screw. High-low sensitivity switch. 360° rotating hot shoe on top for flash unit. Includes PC contact.

SL-2 Remote Flash Trigger (VISL2) .....34.95

### SB4 AC Adapter

This AC Adapter lets you run the 283 or 285HV on 110V AC power.

SB4 AC Adapter (VISE4) .....26.95

### Wein FFA Replacement Foot/Slave for 283/285HV

150' range hot shoe slave with a plus: can be used to permanently repair broken flash foot on any Vivitar 283 or 285 flash unit. Features household-style sync terminal (automatically overrides slave), 1/4"-20 threaded socket, for tripod/lightstand mounting and hardware necessary to make Vivitar repairs. No hard-wiring necessary.

Wein FFA Replacement Foot/Slave for 283/285HV (WEFSV285) .....49.95



# SP STUDIO SYSTEMS

## DC SLAVE STROBES

### Mini Bare Bulb Slave Flash

The DC Mini Bare Bulb Slave is a workhorse that boosts or fills in with any electronic flash by means of its built-in slave. Fits a crowded camera bag on the road and takes on any number of chores in the studio.

- ◆ Has an 'angle cut' case design which allows it to be positioned at any angle
- ◆ 300 flashes with fresh batteries
- ◆ 4-second recycling time
- ◆ GN of 20 feet/ISO 100
- ◆ 120° angle coverage
- ◆ 2.5" diameter x 2 3/4" high

**Mini Bare Bulb Slave Flash (SPMBBS) .....22.95**

### Mini Slave Flash

Use this DC flash unit for lighting small groups of people, as an accent, or background light. It features a standard (1/4") tripod mount socket, and built in slave. It can be used with the included suction cup mount for convenient placement.

- ◆ Select between slave, or sync triggering.
- ◆ Has a "diamond cut" case design which allows it to be positioned at any angle
- ◆ 260 flashes with fresh batteries
- ◆ 8-second recycling time
- ◆ GN50 ft/ISO100, GN30 ft/ISO100 (with diffuser in position).
- ◆ Coverage is 40° horizontal x 55° vertical
- ◆ Measure 2.5 x 2 3/4 x 1 3/8"

**Mini Slave Flash (SPMS) .....24.95**

### Midi Slave Flash

Use this DC flash unit for lighting small groups of people, as an accent, or background light. Features built-in slave trigger, hot shoe for on-camera use. Swing away bracket for low angle adjustments. Built-in 1/4-20 mount for use on light stands, tripods and brackets.

- ◆ Extra power for fill light, side light or background light.
- ◆ GN 45 with ISO 100 film.
- ◆ 50° angle of coverage.
- ◆ 4-second recycling time
- ◆ Select between slave, or sync triggering

**Midi Slave Flash (SPM) .....24.95**



Mini Bare Bulb Slave Flash

Mini Slave Flash

Midi Slave Flash

## InterFit eFlash Flat Panel Flash



*A slim, portable flat panel flash that provides softer light than a conventional on-camera flash. It attaches to a camera hotshoe or can be mounted to either a flash bracket or mini tripod, both available separately. Ideal for digital cameras, these units offer a much softer light than conventional camera flash. The hotshoe mounting bracket will accommodate a second eFlash for even softer lighting. If you use a ring flash, you can add an eFlash as a background light to make the background shadows softer.*

- ◆ Can be mounted horizontally or vertically.
- ◆ Built-in slave "sees" the light from other flashes, and triggers instantaneously.
- ◆ Large, diffused surface area creates a soft box effect. ◆ Powered by 4AA batteries

**eFlash Panel (PAEF): Includes PC cord.....74.95**

### Flash Grip and Extension Arm (PAFG)

Designed for the Interfit E-Flash, but will work with any shoe-mount flash and small 35mm or digital camera. It extends the height of the flash, thus removing background shadows of a subject from the picture frame.....42.50

### Mini Tripod with Extension Arm (PAMT)

With flash shoe connection. This mini-tripod features an extended arm that supports the eFlash, or any other lightweight shoe-mount flash .....32.95

**FLASHES & ACCESSORIES**

**245**

# MORRIS

## AC SLAVE STROBES

The introduction of the original Morris AC slave let photographers turn any room into a flash-lit studio. Now you can choose from six models of AC slaves. With angles of coverage from 50° to 180°, Morris AC's offer unlimited versatility. All AC Slave flashes are powered by any standard 110v AC lamp base socket.

### AC Slave II

Expand your capabilities without sync cables. The AC Slave II boosts or fills in with any electronic flash by means of its built-in slave. Fits in any camera bag on the road and takes on any number of chores in the studio. Simply screw it into any 110v AC socket. Use a room's existing light or lamp sockets to create natural looking room lighting with flash.

- ◆ Provides 50° beam spread coverage
- ◆ 21 W/s of power, Guide Number of 66 (ISO 100, ft.)
- ◆ Green and red LEDs indicate AC power and recycle status



MOACS2  
**\$34.95**

### Wide 100 AC Slave (MOW100ACS)

As its name implies, this slave provides 100° coverage and is ideal for direct lighting when using wide angle lenses or for broad and soft coverage. To concentrate power from a single direction, use multiple Wide 100 AC's to boost the f-stop. Like the other Morris AC Slaves, it is triggered by your main flash unit through a built-in slave sensor. The lamp base fits any standard 110v light socket. The Wide 100 has a GN of 36 (ISO 100, ft.), offers 32 W/s of power and recycles in 5 seconds. Green and red LEDs indicate AC power and recycle status.....**44.95**



### AC Super Slave (MOACSS)

Same as the AC Slave II except more powerful, the AC Super Slave steps up with 30 W/s of power and offers a GN of 72 (ISO 100, ft.) so you can throw light further or operate at higher f-stops. And with 70° of flash coverage, it can be used as a main light, a supplementary fill light or even as a background light. Recycles in 5 seconds .....**49.95**



### AC Bare Bulb Slave (MOACBBS)

For maximum coverage, the AC Bare Bulb Slave features a U-shaped flash tube firing into a diffused dome for broad coverage. Because of its small size, the output still has fairly high contrast, and is ideal to light backgrounds for environmental portraits. Designed to deliver even light to the widest area, the Bare Bulb Slave also makes an excellent general coverage light. When used for portraiture, it delivers a slightly softer light than the other AC's. It can also be used to replace standard household light bulbs in architectural interiors. Features a GN of 26 (ISO 100, ft.), 22 W/s of power and recycles in 5 seconds.....**49.95**

### Master AC Slave (MOMACS)

A coiled 4' removable sync cable and built-in slave let this unit function as either a main or slave light. As a master unit, it connects to a camera's PC terminal by its coiled, removable 4' sync cord. As a slave, it 'sees' the light from your first flash, and fires instantaneously. One Master AC Slave and one or three AC Slave II's are perfect for copystand use. The Master AC Slave has a GN of 66 (ISO 100, ft.), delivers 25 W/s of power, offers 50° of coverage, and recycles in 4 seconds. When used as the master flash, it requires an optional 6-volt PX28 battery .....**38.95**



### 3-Way AC Slave (11141)

Now you can get spot lighting, wide lighting & warming color out of the same AC Slave Unit. Three removable filters control the light output, whether high contrast accent light with 75° of coverage, a diffused fill light with 100° of coverage or a warm tone highlight. The built-in slave circuit fires in perfect sync when another flash fires. It's the same size as a regular light bulb and like all other AC slaves, threads into a standard AC lamp socket. GN of 18 with ISO 100 film .....**CALL**



### Umbrella Clamp Socket (MOCSQ)

The umbrella clamp socket with spring clamp lets you place your light anywhere without a stand! The jaws spread to 2 inches and have a rubber coating to protect the mounting surface. The clamp has a socket with built-in AC power cord and on/off switch on the socket. Compatible with most umbrellas .....**CALL**



### 5 Piece Filter Set:

Create special effects with this set of filters for the AC Slave II with red, blue, green, yellow and 80° diffuser clip on domes.

**5 Piece Screw-in Color Filter Set (MOFSCACS2) .....17.95**

### Three Piece Color Filter Set (MOFSCACBBS):

This set of 3 colored filters adds punch to your Super, Wide 100, Bare Bulb or DC Super Slaves. The filters are red, green and yellow.....**13.95**



**ONE HOUR FREE PARKING**  
AT 349 W. 34th STREET (with purchase of \$100 or more)

# MORRIS

## DC SLAVE STROBES

Morris liberates creative potential with powerful, inexpensive miniature flash units that allow you to direct light exactly where you need it. Shoot with greater range, smaller f-stops and increased depth of field. Morris Slaves are triggered by any flash and deliver extra light for contrast control, backlighting and fill lighting. Ideal for interior photography. Their small size also makes them the ideal companion for compact point-and-shoot cameras, adding no extra bulk to your camera bag. Hide Morris Slaves anywhere in the picture. They offer endless possibilities for the imaginative photographer.

### Mini Slave Flash II (MOMS2)

Use this DC flash unit for lighting small groups of people, as an accent, or background light. It features a standard (1/4") tripod mount socket, and built in slave. Compact and powerful, it can be triggered by your camera or another flash. Includes a wrist strap, diffuser and sync cord.....**31.95**



### Mini Slave Flash Plus (MOMSP)

Use this DC flash unit on the camera, for groups, as an accent, or as a background light. It features a shoe mount, a hi-low power switch and built in slave. Slaveless cap at strobe use. PC-PC sync cord. Includes a detachable wide adapter.....**39.95**

### Midi Slave

Same as the Mini Slave Flash II except a little more powerful. Features a Guide Number of 56 with ISO 100 film vs. GN of 36. Available in white (MOMSW) or black (MOMSB).....**36.95**



### Maxi Slave

This is DC flash unit capable of hot shoe mounting to a camera. Use it for lighting small groups of people, as an accent, or background light. It features a hi-low power switch, and built in slave. It can be used with Morris' optional suction cup mount for convenient placement. Available in white (MOMSWQ) or black (MOMSBQ) versions.....**49.00**

### Mini Slave Wide PLUS (MOMSWP)

Same as the Mini Slave Wide, the PLUS version can be triggered by your camera or another flash, has a built-in test button, and features a standard (1/4") tripod mount socket. Can also be used with Morris' optional suction cup mount for convenient placement.....**31.95**

## Optional Accessories

**Suction Cup (MOSCQ):** Stick it almost anywhere. For use with the Mini Slave Flash II, Mini Slave Wide Plus & Midi Slave.....**4.95**

**Popular Shoe Slave (MOPSSA):** When you need to fire a second flash unit that doesn't have a built-in slave sensor, here's the answer. It will fire a shoe mount or PC cord attached flash unit up to 60' away. Comes with a locking hot shoe, PC socket and a tripod socket.....**23.95**

### DC Super Slave Kit

Like the AC slaves, the DC Super Slave is triggered by any flash unit through its built-in slave sensor or a radio slave. Compact power supply case uses 8 AA batteries for up to 500 flashes (3-sec. recycle time) and comes with shoulder and belt straps and a 4' power cord to give you freedom of movement. Green and red LEDs, mounted under the dome indicate power and recycle status.



- ◆ Guide number of 82 with ISO 100 film; 70° of coverage
- ◆ Includes swivel socket clamp, battery pack, sync cord
- ◆ Open flash test button is provided
- ◆ Spring clamp includes a ball joint for full movement

MODCSK  
**\$99<sup>95</sup>**

## Impact AC Radio Slave System

Impact offers an economical alternative to 4, 16, and 32-channel radio slaves:

A one channel radio slave system for firing an off-camera strobe without using extended sync cables. This allows a photographer who uses AC powered monolights or strobes to fire a strobe up to 50' away from a camera's hot shoe or PC terminal. Ideal for those who want the convenience of a closed-radio channel firing system, without the expense of additional channels.



IMACRSSK  
**\$124<sup>95</sup>**

- ◆ The receiver is always ready; it operates in-line with most AC strobes' power cables, eliminating the worry of receiver battery failure (not including older, round-plug AC units).
- ◆ System includes adapter cords to fire almost any off-camera AC strobe (except for those having a 2-prong household style receiver.)
- ◆ An on-camera strobe may be fired in tandem, using the transmitter's included Super-Mini to Male PC sync cord (flash with on-board PC terminal recommended).
- ◆ Test fire button on the transmitter permits confirmation of your flash system.
- ◆ A flash meter may also be fired from the transmitter by using your PC cord.
- ◆ Included 12v transmitter battery lasts up to 10,000 firings

FLASHES & ACCESSORIES

247

# LUMIQUEST

## POCKET BOUNCERS

### Flash/Lighting Control Accessories

A photographic flash is a small, high intensity source of light which produces generally harsh, unattractive shadows. The quality of this light has been a concern to photographers since the introduction of the flash. Over the last two decades, LumiQuest has developed the most effective and comprehensive line of photographic flash accessories in the world. Their bounce and diffusion devices improve both digital and film photography for millions of professionals and serious amateurs.

By incorporating proven laws of physics into their design, LumiQuest has become the world leader in "hand-held" flash light modifiers. Their bounce and diffusion devices fit a wide range of popular flashes from Nikon, Canon, Sunpak, Vivitar, Quantum, Metz, and others. The ProMax System is a six-piece light modification kit that allows photographers to deal with a variety of lighting situations on location. Whether you select a Pocket Bouncer, UltraSoft, 80-20, Big Bounce, one of their SoftBoxes or the complete ProMax System, you can be assured of fast, convenient improvement over direct flash.



#### Pocket Bouncer

The Pocket Bouncer enlarges and redirects light at a 90° angle from the flash to soften the quality of light and distribute it over a wider area. While no exposure compensation is necessary with automatic flashes, operating distances are somewhat reduced. It folds flat to 4½" x 7¼"

**Pocket Bouncer (LUPB) .....18.49**

#### Pocket Bouncer & MidiBouncer Application:

To soften flash light quality with minimal light loss. To be used with slaves or alone where low ceilings are not available, or where more direct but soft fill light is desired. Light loss is approximately 1-1/3 stops.

#### MidiBouncer

Designed for use with larger professional flashes, the MidiBouncer enlarges and redirects the light at a 90° angle from the flash to soften the quality of light and distribute it over a wider area. Horizontal coverage is approximately 80°. While no exposure compensation is necessary when using the automatic features of the flash, operating distances are somewhat reduced. Folds flat to 5½" x 8¼".

**MidiBouncer (LUMB) .....19.95**



#### 80-20 Pocket Bouncer

The 80-20 enlarges and redirects 20% of the light at a 90° angle from the flash and allows 80% of the light to pass on, to be redirected by another surface — most likely a ceiling.

- ◆ Application: It illuminates the scene with light bouncing off the ceiling while providing "fill" light off the bounce device itself. For use where an 8-9' ceiling is available.
- ◆ Light Loss: Variable depending on ceiling height.
- ◆ Dimensions: Folds flat to 4½" x 7¼"

**80-20 Pocket Bouncer (LUPB8020) .....19.49**

#### UltraSoft

The UltraSoft enlarges and redirects the light at a 90° angle from the flash and then further softens the light by passing it through a frosted diffuser.

- ◆ Application: To achieve an extremely soft look with minimal shadows. For use on an individual flash or to softly illuminate the background in a multiple flash setup. Ideal for close-ups and portraits.
- ◆ Light Loss: Approximately 2½ stops.
- ◆ Dimensions: Folds flat to 4½" x 7¼"

**UltraSoft (LUPBUS) .....19.95**



**EQUIPMENT LEASING AVAILABLE**



# LUMIQUEST

## POCKET BOUNCERS

### Barndoors

Designed for the Pocket Bouncer, the 80-20, and Ultrasoft. It attaches with self-adhesive hook and loop tabs, and can be adjusted to an infinite variety of positions.



- ◆ Application: To enable the photographer to more accurately direct light and reduce its intensity in specific areas.
- ◆ Dimensions: Folds flat to 4½" x 8¾"

**Barndoors (LUBDPB).....19.95**

### Snoot

The Snoot isolates the light to a very specific area. Automatic operation may be affected as illuminated area is limited. Bracketing and/or testing is recommended.



- ◆ Application: To illuminate a specific area of a scene with little or no effect on the surrounding area.
- ◆ Dimensions: Folds flat to 5¼" x 7¼"

**Snoot (LUS).....19.95**

### Battereex

A comfortable, convenient way to carry a rechargeable flash battery. It appears like a shoulder holster yet attaches like suspenders to your pants. It evenly distributes the weight across your shoulders and back. Battereex can be adjusted to fit most photographers and is an important accessory for fast moving photojournalists and wedding photographers.

**Battereex (LUB) .....16.95**



### Big Bounce

Big Bounce enlarges and redirects and softens the light in the same manner as the Ultrasoft, with even softer results.

- ◆ Application: For use where a softer lighting effect is more important than "pocket size" portability (i.e. close-ups, portraits, etc.). Fits the same wide range of flashes as other LumiQuest models.

- ◆ Light Loss: Approximately 3 stops
- ◆ Dimensions: Folds flat to 8½" x 10¼"

**Big Bounce (LUBB).....28.95**



### UltraBounce

The UltraBounce distributes the light over approximately 180° so that it can bounce off walls and ceilings to evenly illuminate a scene. The opaque sensor screen keeps the light from affecting the automatic sensor on most flash units.

- ◆ Application: To soften shadows and help eliminate "Red Eye".
- ◆ Approx. Light Loss: Variable depending on ceiling/wall distances.
- ◆ Dimensions: Folds flat to 2¼" x 3¼".

**UltraBounce (LUUB).....14.95**



### Reflecta-Bounce Kit

This kit enlarges and redirects the light at a 90° angle from the flash. It is designed to soften the quality of light and distribute it over a wider area when used with bare bulb systems such as Armitar, Lumedyne, Norman, Quantum and Sunpak.

- ◆ Application: Can be used alone or with a silver or gold Metallic Insert. The silver insert adds a specular look to highlights; it is particularly useful for weddings. The gold insert adds a warm tone to the scene.
- ◆ Approximate Light Loss: **Reflecta-Bounce:** 1-1/3 stops  
**Silver Metallic Insert:** 2/3 stop **Gold Metallic Insert:** 1 stop
- ◆ Dimensions: Folds flat to 5" x 10"

**Reflecta-Bounce Kit (LURB) .....CALL**



### Table Top Reflector System



A 15-piece system that gives you flexibility and control over the reflective lighting technique typically used for table top photography. It includes crinkle silver surfaces which are reversible to white, and can be easily attached to the rigid mirror reflectors. The unique boom design enables the photographer to suspend a reflector close to the subject, just outside the image area. Light can be precisely directed and isolated through the use of hook and loop adjustments and the assortment of reflective surfaces. The reflectors range in size from 8½" x 11½" to 2" x 3¼". A rugged black storage pouch is also included.

**Table-Top Reflector System (LUTTRK).....59.95**

# LUMIQUEST

## POCKET BOUNCERS

### Metallic Inserts

The Metallic Inserts attach with hook and loop dots to further modify the quality of light. The silver insert adds a specular look to highlights and is particularly useful for weddings. The gold insert adds a warm tone to the scene and is useful for outdoor fill flash.

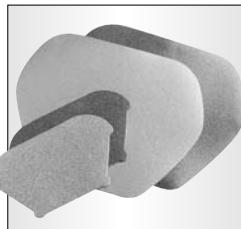

**Metallic Inserts for Big Bounce (LUMIBB)** .....12.76

**Metallic Inserts for Pocket Bouncer and Ultrasoft (LUMIPB)** .....11.16

#### LIGHT LOSS

|                       | Silver      | Gold        |
|-----------------------|-------------|-------------|
| <b>Pocket Bouncer</b> | 2/3 stop    | 1 stop      |
| <b>80-20</b>          | 2/3 stop    | 1 stop      |
| <b>Ultrasoft</b>      | 1-2/3 stops | 2 stops     |
| <b>Big Bounce</b>     | 2-1/3 stops | 2-2/3 stops |



### Cinch Strap

The Cinch Strap enables you to attach LumiQuest accessories without installing self-adhesive loop to your flash. In addition, wrap-around velcro attaches LumiQuest

accessories for a more secure attachment. This is particularly useful with the Big Bounce and the larger SoftBoxes. **Cinch-Strap (LUCS)** .....6.95

### Glo-Notes

A professional darkroom labeling system that contains over 120 pre-printed labels and 45 blanks with letters for customization. The self-adhesive and waterproof labels have bold black text to enable easy reading in white light, safelight and total dark situations. **Glo-Notes (LUGN)** .....8.76



### Mini SoftBox

The Mini SoftBox enlarges and diffuses the light with the flash in the direct flash position. Unobtrusive and low profile, it is ideal for press and other fast-moving situations.

- ◆ Application: To soften shadows and eliminate unpleasant red eye.
  - ◆ Light Loss: Approximately 1 stop.
  - ◆ Dimensions: Folds flat to 3 3/4" x 4 1/2".
- Mini SoftBox (LUSBM)**.....17.95



### SoftBox

The SoftBox enlarges and diffuses the light with the flash in the direct flash position. The light is softened and more evenly distributed as it passes through a center-weighted frosted diffuser. The unique design does not block either exposure sensors or auto focus assist beams on most flashes.

- ◆ Application: To achieve a very soft look with reduced shadow definition. For an individual flash or to softly illuminate the background in a multiple flash set up.

◆ Light Loss: Approximately 1 1/4 stops ■ Dimensions: Folds flat to 5" x 7"  
**SoftBox (LUSB)**.....26.49

### SoftBox II

The SoftBox II enlarges and diffuses the light with the flash in the direct flash position. It is designed exclusively for use on bare bulb flashes such as Lumedyne, Quantum Q Flashes and Sunpak 120J.

- ◆ Application: To soften shadows and eliminate unpleasant red eye.
  - ◆ Light Loss: Approximately 1 1/4 stops.
  - ◆ Dimensions: Folds flat to 6 1/4" x 7 1/4"
- SoftBox II (LUSB2)** .....27.49



### ProMax System

The ProMax System is the latest of LumiQuest's popular photo flash accessories. The basic unit allows 80% of the light to bounce off the ceiling while 20% is redirected forward as fill light. The system includes interchangeable white, gold and silver inserts as well as a removable frosted diffusion screen. The ProMax System will give you studio-like control in a convenient kit which attaches in seconds with hook and loop tabs and folds flat for storage in a sturdy pouch.

- ◆ Application: The 80-20 allows for ceiling bounce with 20% fill. White insert provides a neutral bounce surface when no ceiling is available. Gold insert warms the light for late afternoon fill. Silver insert adds a more specular look to the highlights while maintaining shadow softness.
  - ◆ Light Loss: For 80-20 variable depending on ceiling height.
- ProMax System (LUPMK)**.....36.95



For Any Inquiries Regarding Your Order, Call Our Customer Service:  
 (800) 221-5743 • (212) 239-7765 • FAX: (800) 947-2215 • (212) 239-7549

# LUMIQUEST

## POCKET BOUNCERS

### FX Color Gel System

The LumiQuest FX is a colored gel system that includes an assortment of five colored gels - blue, green, red, yellow and amber. The FX filter holder, designed to fit most flash models, enables the photographer to quickly and conveniently colorize the light for a variety of special effect applications. The system folds flat and comes with a convenient storage pouch.



- ◆ Application: Colorize the light for a variety of special effects.
- ◆ Light Loss: 1 stop.
- ◆ Dimensions: 3 3/8" x 4 1/4"

FX Color Gel System (LUFEXCGS) .....24.95

### ProMax Accessory Kit

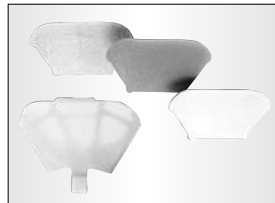

The ProMax Accessory Kit allows you to turn your LumiQuest 80-20 and/or Pocket Bouncer into an interchangeable system. The accessory kit includes a white insert, gold and silver metallic inserts, and a frosted diffusion screen.

#### White Insert:

To be used with the 80-20 where low ceilings are not available, or where more direct but soft fill light is desired. Approximate light loss is 1 1/3 stops.

#### Gold Metallic Insert:

Adds warm tone to the scene. Approximate light loss: 1 stop.

#### Silver Metallic Insert:

Adds a specular look to highlights. Approximate light loss is 2/3 stop.

#### Frosted Diffusion Screen:

Ideal for close-ups and portraits. Approximate light loss with White Insert is 2 1/2 stops; with Gold Insert 2 stops; and with the Silver Insert 1 1/3 stops.

ProMax Accessory Kit (LUAKPM) .....25.95

### THE SHELL by CUSTOM SOLUTIONS

Designed to work with on-camera flashes that swivel, The Shell TSS and The Shell TSM eliminate the frustrating problems of harsh and elongated shadows. Unlike other strobe head accessories, the shape and positioning of The Shell's elegant, compact design keeps the light coming from above the lens in both horizontal and vertical positions - the most flattering light for portraiture. Without The Shell, using the flash head in the direct flash position you would get one type of light - a flat light. When you turn the camera to the vertical position you get another type of light - with a harsh and elongated shadow; neither one is flattering nor do they match. Also very important, The Shell does not interfere with the infrared sensors or TTL metering.

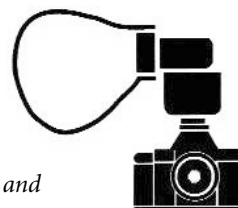

- ◆ The Shell's lightweight, rugged form allows you to store your flash, lens or other accessories nestled protectively inside of it in your camera bag.



taken without The Shell

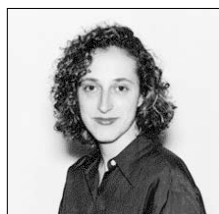

taken with The Shell

- ◆ In addition to the soft light, The Shell also has a wide angle of coverage. Shoot subjects with a 24mm lens without any light fall off. The Shell is an invaluable accessory for the photographer who cannot set up lighting, but desires a soft and flattering light.

#### The Shell TSM (CUSTSM)

Fits smaller swivel head flashes, such as the Nikon SB 28, SB-50DX SB-600 and SB-800, Canon Speedlite 420EX and 550EX, etc .....29.95

#### The Shell TSS (CUS)

Fits potato masher style flashes such as the Metz 60CT-series, Sunpak Auto544, Auto 555, 622 Super, Norman 200B as well as Lumedyne flashes .....29.95

### Flash... The Most Available Light by Quest C. Couch III

An easy reference for creating natural light with flash for digital and film photography. The book is designed to be a "quick read," initially providing an easy to understand working overview to the reader. More in-depth explanations are offered in an "Etc." section. You will learn how to work with a variety of situations on location to obtain natural results and understand the factors that affect your flash photography and how to use them to your advantage. This book will also dispel myths and teach you how to avoid common flash mistakes. Utilize the power of the automatic features through an understanding of their purpose and function. Learn to appreciate your flash as an indispensable tool with a variety of applications. 115 pages, softcover. It contains over 90 photos, charts and illustrations.



Flash... The Most Available Light (LUFMAL) .....19.95

# STO-FEN

## OMNI-BOUNCE

### Flash Diffuser/Dome

The choice of today's working photographers, the Omni-Bounce creates a diffused bare bulb effect giving you even coverage across the entire frame, with lenses from 15mm to 200mm (in 35mm format). The Omni-Bounce is easy to use, and goes on and off your flash in seconds with a custom fitting (NO velcro is ever required for attaching it to your flash), offering photographers a chance to get the best possible light from their flash without having to carry cumbersome equipment. Designed for years of service without the bulk of some other diffusers, it is also small enough to fit easily into your gadget bag or pocket.



### How the Omni-Bounce Works

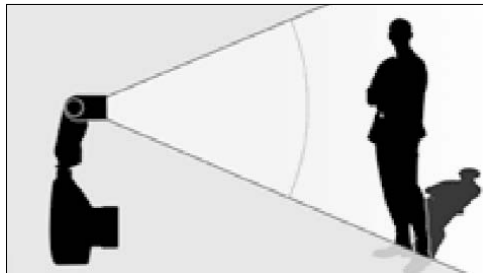

**Straight on Flash (Without the Omni-Bounce):**  
Flash straight on without the Omni-Bounce causes the light to go forward only and creates a harsh shadow behind the subject.



**With Omni-Bounce on the Flash Unit:**  
Flash with the Omni-Bounce installed and tilted to 45° gives a nice soft wrap around of light with a soft shadow behind the subject.

### Green and Gold Omni-Bounce



The Green and Gold Omni Units are used for special lighting situations. The Green is used for fluorescent lighting in conjunction with an FLD or 30M filter on the camera lens. The Gold is for warming skin tones and for overall warming in flash filled available light shots. They both mount the same as the regular Omni for your flash unit.

### Two-Way Universal Bounce Card

The TW-UNI is a pocket-sized bounce card that gives you the advantage of bouncing the flash without the need of a ceiling. The unit is small enough to fit into a shirt pocket and yet delivers a big punch of light. The package also includes a mini panel that provides a kicker light for fill-lighting use. To mount on your flash, the TW-UNI includes the UNI Mount which is a bracket that attaches to the back of the flash head with 3M foam core tape.



Shown mounted on an optional flash unit

#### Omni-Bounce

OM-199A, OM-422, OM-522, OM-SB16, OM-5600S, OM-4000, OM-300T, OM-CT45, OM-CT60, OM-B, OM-C, OM-EZ, OM-EX, OM-PZ4, OM-MZ2, OM-MZ3, OM-MZ6, OM-MZ40, OM-MZ50, OM-MZ70, OM-SB5, OM-PZ8, OM-600, OM-EY .....(ea.) 16.95

#### Green & Gold Omni-Bounce

OC-600GL, OC-600GR, OC-60GL, OC-60GR, OC-CBGL, OC-CBGR, OC-EXGL, OC-EXGR, OC-EYGL, OC-EYGR, OC-EZGL, OC-EZGR, OC-MZGL, OC-MZGR, OC-SBGL, OC-SBGR .....(ea.) 17.95

#### Green & Gold Omni-Bounce Sets

OC-600SET, OC-CBSET, OC-EXSET, OC-EYSET, OC-EZSET, OC-MZSET, OC-SBSET ..... (ea.) 29.95

#### Two Way Bounce

TW-UNI, TW-422, TW-B, TW-285, TW-199A, TW-411 ..... (ea.) 16.95



For Any Inquiries Regarding Your Order, Call Our Customer Service:  
(800) 221-5743 • (212) 239-7765 • FAX: (800) 947-2215 • (212) 239-7549

# STO-FEN

## OMNI-BOUNCE

| FLASH UNIT                    | OMNI   | TWO-WAY | GREEN OMNI | GOLD OMNI | COLOR OMNI SET |
|-------------------------------|--------|---------|------------|-----------|----------------|
| Canon 199A                    | OM199A | TW199   | —          | —         | —              |
| Canon 300EZ                   | OMUNI  | —       | —          | —         | —              |
| Canon 300TL                   | OM300T | TWUNI   | —          | —         | —              |
| Canon 380EX                   | OMC    | TWB     | OCCBGR     | OCCBGL    | OCCBSET        |
| Canon 420EX                   | OMEX   | TWUNI   | OCEXGR     | OCEXGL    | OCEXSET        |
| Canon 420EZ/430EZ             | OMB    | TWB     | OCBGR      | OCBGL     | OCBSET         |
| Canon 540EZ/550EX             | OMEZ   | TWUNI   | OCEZGR     | OCEZGL    | OCEZSET        |
| Canon 580EX                   | OMEY   | TWUNI   | OCEYGR     | OCEYGL    | OCEYSET        |
| Contax TLA280/TLA360          | OMC    | TWUNI   | OCCBGR     | OCCBGL    | OCCBSET        |
| Metz 32 MZ-3/Z-1/Z-2          | OMMZ2  | —       | —          | —         | —              |
| Metz 36AF                     | OMMZ3  | TWUNI   | OCMZGR     | OCMZGL    | OCMZSET        |
| Metz 40 AF4                   | OMPZ4  | TWUNI   | OCMZGR     | OCMZGL    | OCMZSET        |
| Metz 44AF                     | OMMZ2  | TWUNI   | —          | —         | —              |
| Metz 50 MZ5 Series            | OMMZ50 | —       | —          | —         | —              |
| Metz 54 MZ3/MZ4               | OMC    | TWUNI   | OCCBGR     | OCCBGL    | OCCBSET        |
| Metz 70 MZ4/MZ5               | OMMZ70 | —       | —          | —         | —              |
| Metz CT/CL45 Series           | OMCT45 | TWUNI   | OCCBGR     | OCCBGL    | OCCBSET        |
| Metz CT60 Series              | OMCT60 | —       | OC60GR     | OC60GL    | OC60SET        |
| Minolta 3600HS                | OMPZ8  | TWUNI   | —          | —         | —              |
| Minolta 4000AF                | OM4000 | TWUNI   | —          | —         | —              |
| Minolta 5200i/5400hs/5400xi   | OMC    | TWUNI   | OCCBGR     | OCCBGL    | OCCBSET        |
| Minolta 5600hs                | OMMZ6  | TWUNI   | —          | —         | —              |
| Nikon SB-16                   | OMSB16 | TWUNI   | OCCBGR     | OCCBGL    | OCCBSET        |
| Nikon SB-24                   | OMC    | TWB     | OCCBGR     | OCCBGL    | OCCBSET        |
| Nikon SB-25/SB-26             | OMC    | TWUNI   | OCCBGR     | OCCBGL    | OCCBSET        |
| Nikon SB-28/SB-28DX           | OMMZ3  | TWUNI   | OCMZGR     | OCMZGL    | OCMZSET        |
| Nikon SB-50DX/80DX/800        | OMSB5  | TWUNI   | OCCBGR     | OCCBGL    | OCCBSET        |
| Nikon SB-600                  | OM600  | TWUNI   | OC600GR    | OC600GL   | OC600SET       |
| Pentax 330FTZ                 | OMMZ3  | —       | OCMZGR     | OCMZGL    | OCMZSET        |
| Pentax AF360FGZ               | OMPZ8  | TWUNI   | —          | —         | —              |
| Pentax AF500FTZ               | OMC    | TWUNI   | OCCBGR     | OCCBGL    | OCCBSET        |
| Sigma 420/430                 | OMMZ3  | TWUNI   | OCMZGR     | OCMZGL    | OCMZSET        |
| Sigma 500 Series              | OMC    | TWUNI   | OCCBGR     | OCCBGL    | OCCBSET        |
| Sunpak 355AF                  | OMMZ3  | TWUNI   | OCMZGR     | OCMZGL    | OCMZSET        |
| Sunpak 422/433/444            | OM422  | TW422   | OCCBGR     | OCCBGL    | OCCBSET        |
| Sunpak 4500DX/455/522/544/555 | OM522  | —       | —          | —         | —              |
| Sunpak MZ440AF                | OMC    | TWUNI   | OCCBGR     | OCCBGL    | OCCBSET        |
| Sunpak PZ4000AF               | OMPZ4  | TWUNI   | OCMZGR     | OCMZGL    | OCMZSET        |
| Sunpak PZ-40X                 | OM4X   | TWUNI   | —          | —         | —              |
| Sunpak PZ5000AF               | OMEZ   | TWUNI   | OCMZGR     | OCMZGL    | OCMZSET        |
| Vivitar 283                   | OMB    | TWB     | OCCBGR     | OCCBGL    | OCCBSET        |
| Vivitar 285                   | OMB    | TW285   | OCCBGR     | OCCBGL    | OCCBSET        |
| Vivitar 3700/4600/5600        | OM5600 | TWB     | OCCBGR     | OCCBGL    | OCCBSET        |
| Vivitar 5600 Zoom             | OMB    | —       | OCCBGR     | OCCBGL    | OCCBSET        |
| Vivitar 600N                  | OMEZ   | —       | OCEZGR     | OCEZGL    | OCEZSET        |
| Vivitar 728AF                 | OMMZ3  | TWUNI   | OCMZGR     | OCMZGL    | OCMZSET        |
| Vivitar 730AF                 | OM300T | TWUNI   | —          | —         | —              |
| Vivitar 836/840AF             | OMMZ3  | TWUNI   | OCMZGR     | OCMZGL    | OCMZSET        |
| Vivitar 850AF                 | OMC    | TWUNI   | OCCBGR     | OCCBGL    | OCCBSET        |

# CUSTOM BRACKETS

## CAMERA & FLASH BRACKETS



Unlike conventional brackets, the QRS-35 is designed for you to hold the camera rather than the bracket, for a more natural way of shooting. Available for many cameras including the Canon EOS Elan 7N, EOS-1v, and EOS-3, Nikon F100, F5, and F6, Minolta Maxxum 7 and 9. The QRS-35 has a semi-circular track with a camera platform which slides quickly to switch from horizontal to vertical, and vice-versa. Spring detents lock the platform securely in either position, but just a good nudge lets you switch camera orientation. For studio use the system is available without the flash holder. The brackets are machined from aluminum, for light weight and strength, and then anodized black for a professional look.

- ◆ Stands upright - protecting the camera and flash
- ◆ Base is ready for tripod quick-release
- ◆ Lightweight aluminum construction
- ◆ Easily switch camera/flash from system to system
- ◆ Camera mounting plates with or without vertical grips
- ◆ Flash mounting plates allow adjustable height and tilting (Metz 45/60, 50/70 ready, others optional)
- ◆ Available with textured adjustable handle (QRS-35-H)
- ◆ Non-tripod mountable version for those who don't want to carry large, bulky brackets (QRS-35-PJ)
- ◆ Holds accessories (radio slaves, TTL modules, focusing lights, etc.) via optional bracket accessory adapters

- QRS-35 (CUQRS35)**  
35mm Style Rotational Flash Bracket (no handle). 12¼ x 8 x 4" (HWD), weighs 23 oz.....**164.95**
- QRS-35-H (CUQRS35H)**  
Same as above, includes textured adjustable handle. 14 x 8 x 7" (HWD), weighs 27 oz .....**169.95**
- QRS-35-EV (CUQRS35EV)**  
Extended Version adds 2" extra clearance for TTL Modules and Radio Slaves. It's dimensions are 14 x 9¼ x 7" (HWD) deep, it weighs 28 oz.....**179.95**
- QRS-35-PJ (CURS35PJ)**  
For photojournalism. Includes handle but is non-tripod mountable. 11½ x 8 x 12½" (HWD).....**159.95**
- QRS-35-SV (CUQRS35SV)**  
Studio Version (camera bracket only, no flash holder). 7-¼ x 5½" (HW), it weighs 10 oz .....**142.95**

**After choosing a bracket, select a camera mounting plate, flash mounting plate and accessories (next page) to complete your system**

### 35mm Camera Mounting Plates



**C35-CD (CUC35CD):**  
Approximately 3¾" center of lens to the bottom of the camera. It is compatible with

QRS-35-PJ and QRS-35-SV brackets.....**32.95**

**C35-CD1 (CUC35CD1):**  
Approx. 3¾" center of lens to bottom of camera. Compatible with QRS-35, QRS-35-H, QRS-35-EV brackets.....**36.95**

**C35-S (CUC35S):**  
1¼" to 1¾" center of lens to bottom of the camera. Compatible with all brackets.....**29.95**

**C35-T (CUC35T):**  
2½" to 3" center of lens to bottom of camera. Compatible with all brackets.....**28.95**

### Flash Mounting Plates

**F35-C (CUF35C)**  
For Canon Off Camera Shoe Cord 2.....**19.95**

**F35-N (CUF35N)**  
For Nikon SC-17, SC-28 cords.....**19.95**

**F35-N1 (CUF35N1)**  
For Nikon SC-29 Off Camera TTL AF Cord (not for QRS or QRS-35-H).....**21.95**

**FL (CUFL)**  
For Lumedyne Classic Series (round flash head type) .....**19.95**

**FM (CUFM)**  
For Metz MZ50 and MZ70 (barrel type), not for QRS, QRS-35 or QRS-35-H .....**28.95**

**FN (CUFN)**  
For Norman heads with 1/4"-20 thread ...**19.95**

**FQ (CUFQ)**  
For Quantum Q Flash T4D (not for QRS or QRS-35-H) .....**19.95**

**FS (CUFS)**  
For Sunpak 544 and 622 (barrel type) .....**24.95**

**FT (CUFT)**  
For Shoe Type - Vivitar 283 & 285, Metz 40 and 54, Sunpak 120J, and others .....**24.95**

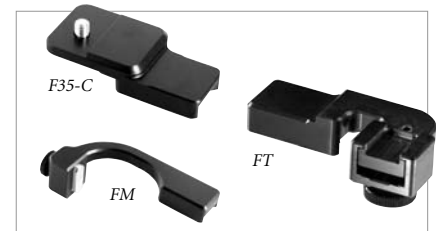

# CUSTOM BRACKETS

## CAMERA & FLASH BRACKETS

### Bracket Accessories

**AP - Accessory Plate (CUAPQ)**

The AP has many uses when attached to the upright. From supporting radio slaves, TTL modules and focusing lights .....**19.95**

**FR - Flash Quick-Release (CUFR)**

Flash quick-release receiver replacement for bracket. It accepts all accessory flash mounting plates as well as the Metz 45 and 60 series flashes directly. ....**19.95**

**LF - L-Flash Bracket (CULF)**

For 35mm cameras, the LF allows the flash to move 1", 2" or 3" back for better balance in standing when using different lenses .....**16.95**

**MC Cold Shoe (CUMC)**

Use it to attach a Radio slave, Focusing light and TTL module to the upright .....**16.95**

**QR - Tripod Quick-Release (CUQRQ)**

The tripod quick-release is a must for taking full advantage of Custom Bracket bracket systems when using a tripod. Attach to a tripod to accept either the bracket or camera .....**39.95**

**Strap (CURHS)**

A velcro adjustable leather strap. The strap adds insurance for holding and carrying your brackets. It replaces the original handle and still allows the handle to be indexed for your comfort. Not for QRS-35.....**49.95**



### Battery Holders



**BH-1 Battery Holder (CUBH1)**

Designed to support clip type batteries (Quantum, Lumedyne, etc.) on a tripod or lightstand of 1/2" to 1/4" .....**18.95**



**BH-2 Battery Holder (CUBH2)**

Designed to support the Metz 60 series battery from the bottom using a 2 piece holder. The battery mount stays attached to the bottom of the battery, while the receiver attaches to the tripod or lightstand. This holder uses the battery's own weight to keep it in place and allows for fast on / off operation on a tripod or lightstand of 1/2" to 1/4" in diameter .....**26.95**



**BH-3 Battery Holder (CUBH3)**

Designed to support the (Classic Series) power module from Lumedyne from the "D" hooks with or without the strap attached. The holder allows for one handed fast on / off operation on a tripod or lightstand of 1/2" to 1/4" .....**26.95**

**BH-4 Battery Holder (CUBH4)**

Designed to support the (Signature Series) power module from Lumedyne from the "D" hooks with or without the strap attached. The holder allows for one handed fast on / off operation on a tripod or lightstand of 1/2" to 1/4" .....**29.95**

### CB Junior Bracket & Accessories



**CB Junior Flash Rotating Bracket (CUCBJ)**

Adjustable pivoting aluminum flash arm keeps the flash centered above the lens for both horizontal and vertical shooting. It features a comfortable foam grip for carrying, and a swing-out leg for standing. Dimensions are 7 1/4 x 7 1/4 x 5" (HWD), it weighs 17 oz .....**89.95**

**CN-JR Anti-Twist Plate (CUCNJR)**

An anti-twist mount that prevents Canon and Nikon off-camera shoe cords from twisting or rotating from the mounting screw. It locks the cord to the bracket to prevent twisting .....**14.95**

**FT-JR Flash Shoe Mount (CUFTJR)**

Attaches shoe mount flash to the CB Junior flash rotation bracket.....**16.95**

FLASHES & ACCESSORIES  
255

# CRANE

## FLASH BRACKETS

### Multi Brackets

A must for all wedding photographers or anyone who does location/candid and multiple-light shooting, the Multi-Bracket is designed to conveniently hold your portable flash, power supply, radio slave receiver or photo slave and an umbrella for bounce lighting with the strobe sensor facing subject, allowing automatic exposure control (except MB-2). They are excellent when mounted on a mono-pod or small light stand for easy mobility or for use on an extension pole and are extremely well balanced. Equipped with a flash "quick release" for your convenience and an adjustable tilting head for easy positioning, they accept all stands up through 5/8". Multi-Brackets are offered in four different models to accommodate virtually all portable strobes.



**MB-1 Multi Bracket (CRMB1):**

For Sunpak Auto-Pro 120J, Lumedyne, Norman, Quantum Q-Flash, and Mini Lights AC/DC Version (1/4"-20 thread mount).....**74.95**

**MB-2 Multi Bracket (CRMB2):**

For all "shoe-mount" style flash heads. Will block the Auto Sensor of most flashes. Use the flash in Manual, or TTL, with the proper TTL off-camera cord.....**74.95**

**MB-2SLS Multi Bracket (CRMB2SLS):**

Same as MB-2 except it includes a locking shoe mount for flash...**78.95**

**MB-3 Multi Bracket (CRMB3):**

For Metz 45 and 60 Series handle mount flashes .....**74.95**

**MB-4 Multi Bracket (CRMB4):**

For Sunpak handle mount flashes .....**74.95**

### Multi Bracket Accessories

**Small Battery Holder (CRBHS)**

Designed to securely hold all Quantum battery packs and other items with a belt clip (i.e. belt pouch for film magazines, filter and vignette pouch) to most light stands, mono-pods and tripods. Its small, lightweight design is ideal for wedding, location and studio use. Black Anodized .....**23.95**

**Universal Battery Holder (CRBHU)**

The Universal Battery Holder is specifically designed to securely hold all Quantum, Lumedyne and Metz 60 Series battery packs to most light stands, mono-pods and tripods. Its rigid, extremely lightweight aluminum construction provides great benefit without adding excess weight to your bag. Ideal for commercial, wedding, location or studio use. Recommended for use with Lumedyne systems and Metz 60 Series strobes when using Multi-Brackets MB-1, MB-2, MB-3, and MB-4. Black Anodized .....**38.95**

**AH-1 Accessory Holder (CRAH1)**

For Bogen 3021, 3021B, 3033 and 3033B heads .....**14.95**

**AH-2 Accessory Holder (CRAH2)**

For Bogen 3046 & 3046B tripods .....**14.95**

**AH-3 Accessory Holder (CRAH3)**

For Bogen 3036, 3036B, 3051 and 3251B tripod.....**19.95**



**Locking Accessory Shoe (CRSLS):**

Allows mounting of a shoe mount flash, radio slave, or off-shoe cord to a Crane flash bracket .....**9.95**

**Clip for Norman Batteries (CRNBHC):**

Clip to attach the Norman 200 and 400B series batteries to a Bogen lightstand or tripod. Requires either the Small or Universal Battery Holder.....**13.50**

**Clip for Quantum**

**Batteries (CRQPX)**

Clip to attach the Quantum QPAQ-X Power Pack to a Bogen lightstand or tripod.

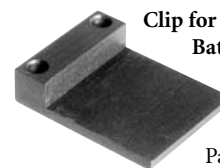

Requires either the Small or Universal Battery Holder.....**13.50**

**Dark Slide Holder (CRDSH)**

A convenient way to secure your dark slide that features Velcro strips .....**5.50**

**Quick Release Adapter with Plate (CRQS)**

The 35mm Quick Shoe provides quick camera mounting, while eliminating thread wear on the camera. The small light-weight foot can remain on the camera for quick mounting. Additional camera feet are available.....**54.95**

**Quick Release Plate (CRQRP)**

For the Quick Release Adapter.....**16.49**



For Any Inquiries Regarding Your Order, Call Our Customer Service:  
(800) 221-5743 • (212) 239-7765 • FAX: (800) 947-2215 • (212) 239-7549



# FLASHFRAME

## FLASHFLIP FLASH BRACKETS

### FlashFlip 100 (FLMFF)

Keep your flash high and directly over the camera lens in the horizontal and vertical positions, eliminating red-eye. By having the flash high above the lens, shadows are cast behind the subject and not seen in the photograph. The FlashFlip works with most 35mm cameras and shoe-type flashes. Supplied with locking shoe and 1/4-20 flash mounts. All metal construction.....**49.95**

### FlashFlip PF (PlatForm) (FLFF200)

The same design as the FlashFlip, but with an ultra-steady platform base that allows the user to stand the entire assembly (camera, flash and bracket) up for easier access and more stability. In addition, the base also has more surface area that makes it ideal for larger cameras.....**59.95**

### FlashFlip VF (VertiFlash) (FLFF300)

The FlashFlip VF allows for horizontal and vertical shots keeping the flash high and centered above the lens. In the vertical mode, your hands are "on top" of the camera, the natural and most popular way to shoot verticals. Heavier bracket holds larger pro-style SLRs .....**69.95**

### FlashFlip H.O.T. (Hands On Top) (FLFF400)

The FlashFlip H.O.T. features the same design as the other FlashFlips, allowing for horizontal and vertical shots while keeping the flash high and centered above the lens. In the vertical mode, this bracket lets you shoot the way you would normally with your "Hand on Top" of the camera. Specially designed, offset platform base allows the entire assembly (camera, flash and bracket) to stand up on its own and gives enough clearance for even the largest hand .....**69.95**

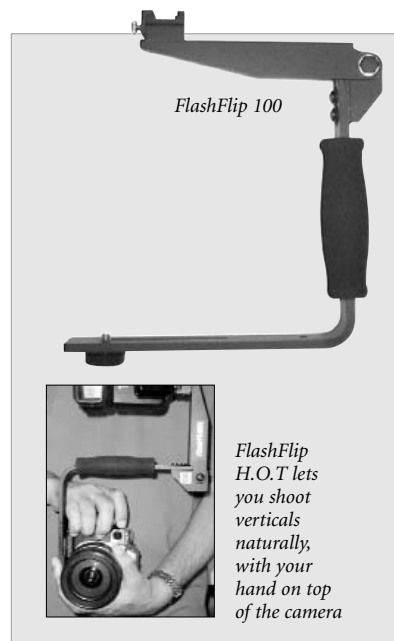

**FLASHES & ACCESSORIES**  
**257**



## STRATOS Flash Brackets

Designed to meet all lighting conditions and problems, Stratos flash brackets eliminate flash shadows, red-eye and instantly balance your lighting. Precision-machined of the highest quality black anodized 6061 aircraft aluminum, Stratos brackets are lightweight, yet indestructible. Both the camera mount and the flash mounts are adjustable and the shoe has a built-in quick release. They also have an anti-fatigue, non-slip contour foam grip that is one of the most comfortable on the market. The brackets provide 8" or 10" elevation for the flash, with a pivoting flash arm that keeps the flash over the lens in both horizontal and vertical positions, thereby reducing red-eye and unwanted side-shadows. The bracket provides 3" flash alignment on the pivoting flash arm, and 4" camera adjustment on the camera base plate. By having the flash high above the lens, shadows are cast behind the subject and are therefore not seen in the photograph.

- ◆ 8" or 10" length post
- ◆ 4" horizontal camera adjustment
- ◆ Anti-fatigue contoured, non-slip foam rubber grip
- ◆ Easy flip action for perfect vertical and horizontal flash shots. Flash arm flips a full 180°
- ◆ 3" horizontal flash adjustment ensures you flash always stays centered over your lens
- ◆ 1/4" thick base plate with anti-twist rubber base pads
- ◆ 835 Bracket is available in vibrant anodized colors (red, gold and blue) as well as black

#### 835 Bracket with 8" Post:

Available in Black (STB358B), Red, (STB358R), Blue (STB358BL), and Gold (STB358G) .....**42.95**

#### 835F Folding Flash Bracket with 8" Post (STB358FB):

Same as the standard 835 except that it folds together flat, to fit more easily into a camera bag. Black color .....**54.95**

#### 1035 Bracket with 10" Post (STB3510):

Same features as the standard 835 except with a 10" post. Black color .....**44.95**

#### Mini Digital Folding Bracket

Designed for compact digital or 35mm cameras. It folds together flat and it will easily slip into a shirt pocket or camera bag. It is 4 3/8" x 5" (HxW). Available in Black (STBDCB), Blue (STBDCBL), Red (STBDCR), Gold (STBDCG), and Silver (STBDCS) .....**19.95**

- Stratos Cable Release Kit (STCR20) .....**22.95**
- Stratos 1/4" Flash Mount Adapter (STFM.2520Q) .....**19.95**
- Stratos Metz Flash Mount Adapter (STFMM) .....**29.95**
- Stratos Metz Sensor Adapter (STMSA) .....**19.95**
- Stratos Non-Rotating Arm Adapter (STNRAA) .....**27.95**

**ORDER & INFO. (212) 502-6340 • FAX: (212) 239-7770 (800) 947-7008**  
**1-800-290-6750 • www.bhphotovideo.com**



# LINDAHL

## ULTRA EFX SHADE 2000

FLASHES & ACCESSORIES

258

The Ultra EFX Shade 2000 has a revolutionary mounting system that allows your lens to rotate and zoom while keeping the lens shade in line with your camera. Other shades either don't allow lens movement or spin along with the lens, making shooting awkward. The inexpensive and innovative Ultra EFX Shade 2000 is the industry's only filtration and vignetting system that works properly with zoom and standard lenses — even if your lens rotates. It puts an end to lens flare and helps you create dramatic professional effects. Just screw on the appropriate lens adapter disk and attach the shade. The bellows extends and contracts on a pair of black aluminum segmented rods. The camera mounting bracket attaches to your camera tripod socket and locks in place with a screw.

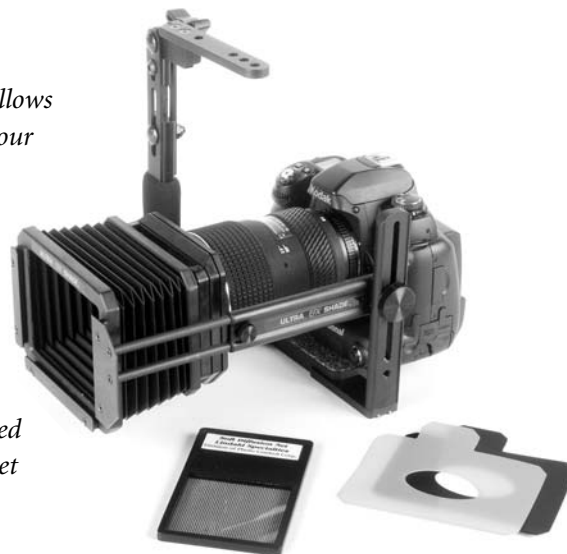

### Ultra EFX Shade 2000 System (LILHUEFX200Q)

Includes the bellows unit, camera mounting bracket, pro flash bracket, one diffusion filter and two vignettes.

Requires EFX Adapter Disk.....299.95



### EFX Pro Flash Bracket (LIPFBUEFX200)

This bracket can be attached to the Ultra EFX 2000 Shade Accessory or used alone. It allows your flash to remain centered over the lens in both horizontal and vertical compositions. The sleek design allows you to handle your camera naturally and access your vertical shutter release easily. Fully adjustable to accommodate vertical grips, motor drives or similar accessories. Solid construction of all aluminum, accommodates a tripod with a standard 1/4-20 thread.....108.95

### Ultra EFX 2000 Shade Accessory (LIAUEFX2000)

Adds on to the EFX Pro Flash Bracket (LIPFBUEFX200), to make a complete Ultra EFX Shade 2000 System. It includes the shade, diffusion filter and two vignettes .....199.95

### Ultra EFX Lens Hood 2000 (LILHUEFX2000)

This innovative hood is for use alone, without a Pro Flash Bracket. The mounting system allows your lens to rotate and zoom while keeping the lens shade in line with your camera. The mounting bracket attaches to your camera tripod socket and locks in place with a screw. It includes the shade, diffusion filter and two vignettes, and requires the appropriate EFX Adapter Disk .....199.95

### EFX Pro Flash

#### Bracket Accessory (LIPFBAUEFX20)

Adds on to the Ultra EFX Lens Hood 2000 (LILHUEFX2000), to make a complete Ultra EFX Shade 2000 System .....126.95

## EFX VIGNETTES

Each package includes two vignettes—one black and one white, 3½ x 4½". The black (Low Key) vignette is opaque and ideal for blocking out unwanted areas of your photograph. The white (Hi-Key) vignette is translucent and will lighten the edges as well as blocking out detail.

### Horizontal Smooth Oval (LIVHSOUEFX):

General purpose vignette used for both horizontal and vertical compositions. Smooth edges for a wide range of apertures.....13.95



**Horizontal Scalloped Oval (LIVHSOUEFXQ):** Same opening as above, except with scalloped edge for better blending. Use large apertures.....13.95

**Smooth Circle (LIVSCUEFX):** Circles allow proper vignetting of a single subject. Wide range of apertures.....13.95

**Serrated Diagonal Oval (LIVSDOUEFX):** Ideal for s-curve compositions. Mask can be flipped for left-to-right compositions. Serrated edges allow for the best blending.....13.95

**Scalloped Horizontal Group (LIVSHGUEFX):** Use wider apertures for multiple subject compositions.....9.95

**Scalloped Vertical Group (LIVSVGUEFX):** For use with vertical compositions 9.95

**Horizontal Bottom Arc (LIVHBAUEFX)** Darken foreground to remove unwanted objects or to center attention toward the subject.....9.95



EQUIPMENT LEASING AVAILABLE

## EFX VIGNETTES, ADAPTER DISKS, FILTERS

### Montaging Masks (LIMSMEUEFX)

This set of six enables you to do several different types of multiple exposures. For optimal results, multiple exposures require a full manual mode and all elements within the multiple exposure should use the exact same focal length .....**24.95**



### EFX Blank Masks



These masks are solid material that allow you to cut your own

masks for vignetting or multiple exposures.  
**Set of 4 Black Masks (LIBMSBUEFX) .....13.95**  
**Set of 4 White Masks (LIBMSWUEFX) .....13.00**  
**Set of 4 Masks (LIBMSBWUEFX)**  
 2 black and 2 white masks .....**16.95**

### EFX VIGNETTES, continued

#### EFX Vignette Frames (LIVFSUEFX)

Thin plastic with adhesive on one side to attach your own vignette material. Place any type of material between 2 frames and cut your custom-designed opening and make your own vignettes. Package of 6, makes 3 finished vignettes.....**33.50**

#### Colored Vignettes (LIVCSUEFX)

Add artistic color to your photographs for extra versatility and unique effects. Package includes six horizontal, smooth ovals, one each in the following colors: Gray, Green, Lavender, Orange, Yellow, and Aquamarine.....**29.95**

#### EFX Pro

##### Mesh Vignettes (LIVSPMUEFX)

Designed in layers to give a subtle, gradual low key vignette. Two different size ovals are included in the set for use with a variety of focal lengths. A bottom scoop for both horizontal and vertical compositions makes this set complete. Package of 4 .....**49.50**

#### EFX Mid-Key Vignettes



Gently lighten the edges of your photograph to blend beautifully with contemporary Hi and Mid-Key settings.

**Package of 3 (LIVSMKUEFX).....49.95**

**Set of 2 Uncut (LIVSCMKUEFX).....29.95**

#### Magic Edge Vignettes



Create a dream-like edge around your subject.

This vignette is used in the front slot of the EFX Shade and gently diffuses the edges of your photograph. Ideal for any situation.

**Horizontal Oval (LIVMEHOUUEFX).....19.95**

**Vertical Oval (LIVMEVOUEFX).....17.50**

**Custom Vignette Kit (LIVSCMEUEFX)**

Package of 2 uncut .....**24.95**

### EFX Adapter Disks

*These metal threaded are designed to work exclusively with the Ultra EFX Shade.*

|   |   |   |
|---|---|---|
| 49mm EFX Adapter Disk (LIAD49) .....17.00 | 58mm EFX Adapter Disk (LIAD58) .....17.00 | 72mm EFX Adapter Disk (LIAD72) .....17.00 |
| 52mm EFX Adapter Disk (LIAD52) .....17.00 | 62mm EFX Adapter Disk (LIAD62) .....17.00 | 77mm EFX Adapter Disk (LIAD77) .....17.00 |
| 55mm EFX Adapter Disk (LIAD55) .....17.00 | 67mm EFX Adapter Disk (LIAD67) .....17.00 | 82mm EFX Adapter Disk (LIAD82) .....44.95 |

### PROFESSIONAL FILTERS

#### Harrison & Harrison Diffusion Effect

Diffusion effect filters are designed to create a general softening of the image. This special effect sets a distinctive mood or style. Sold in progressive steps, individually or as a set.



No effect      Diffusion Effect #1      Diffusion Effect #2      Diffusion Effect #3

**Diffusion Effect #1 (LIHHD1).....88.95**  
**Diffusion Effect #2 (LIHHD2).....88.95**  
**Diffusion Effect #3 (LIHHD3) .....69.95**  
**Diffusion Effect Set (LIHHD3Q):**  
 Set of all 3 Diffusion Effect filters in a fabric pouch.....**249.95**

#### Harrison & Harrison Black Dot Texture Screen Diffusion Set

The Black Dot Texture Screens soften images without a whitish veil. Even as the degree of diffusion increases, Black Dots allow retention of contrast so there's no "fuzzy" look. They make retouching easy, too. These filters require aperture compensation of approximately 1 stop, regardless of the degree of diffusion.



**Black Dot Texture Screen Diffusion Set (LIHBDTSS)**  
 Set of 5 filters in a wood storage box .....**529.95**

# LINDAHL

## PROFESSIONAL FILTERS

### Soft Touch

#### Diffusion Filter (LISTD33)

Optical glass combined with a soft gentle diffusion effect makes this filter suitable for so many applications. Gentle diffusion for portraits, satin effect on still life subjects – quality diffusion for any subject.....74.50



### Lindahl Soft Filters

Lindahl Acrylic filters are an economical choice for diffusion effects. These durable filters are worth considering for location photography and other situations where breakage might be a concern. Three filters are available, and offered individually or in sets.

- Lindahl Soft Lite (LISFL) .....53.00
- Lindahl Soft #1 (LISF1) .....43.95    Lindahl Soft #2 (LISF2).....43.95
- Lindahl Soft #1 and Lite Filter (LISFL1) .....73.95
- Lindahl Soft #1 and Soft #2 (LISF12) .....69.95

### Graduated Gray Rotating Drop-In (LIGG33)

A neutral gray graduated filter in the Lindahl rotating drop-in style. Half clear gradually turning to gray to darken about 1 stop. You can rotate to darken the top, bottom, or anywhere in-between. Use as a natural vignette even at small apertures.....64.95

### Coral Filters

Coral filters are available in 2 versions: as a standard 81B light Coral filter, and as an 81B with a slight soft focus filter. The warming effect is useful for taking photographs in the shade or open shade on sunny days, and can improve the color rendition on backlight subjects in sunshine. They require an exposure increase of approximately 1/3 stop.

- Coral Filter (LIFC33):**  
81B .....74.95
- Coral Filter Set (LICS33):**  
The set contains a Coral Filter and Coral Soft Filter. It includes a fabric pouch .....224.00
- Coral Soft Filter (LICS33Q):**  
81B plus Soft .....99.95

### Soft Rings Diffusion

Soft Rings Diffusion filters are a series of 3 filters with a concentric ring cast into the glass. As the diffusion increases, the contrast level will remain virtually unchanged. We recommend that these filters be used in the normal portrait range of apertures such as f/8-f/5.6. Excessive depth-of-field could produce an uneven diffusion effect. Soft rings provide an ideal diffusion in conjunction with all Lindahl Vignettes.



- Soft Rings #1:**  
(LISD133).....88.95
- Soft Rings #2:**  
(LISD233).....88.95
- Soft Rings #3: (LISD333Q).....79.95**
- Soft Rings Diffusion Set (LISDS33Q):**  
Set of all 3 soft rings diffusion filters in a fabric pouch.....249.95

### Sepia Filters (LISF)

A sepia filter produces a brown colored image on color film allowing the printing of sepia toned prints with color paper. The sepia filter requires 2-stops aperture compensation. Best results are obtained with low key, muted tones. It's ideal for outdoor photographs at dusk for a silhouette .....57.50



### Sunset Filter (LISSF)

This sunset filter is a resin filter that creates a warm foreground with an even warmer sky.....53.00

### Close-up Drop-in Filters

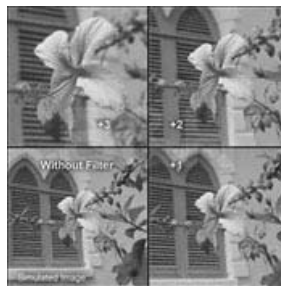

Close-up drop-in filters are simple lenses that allow closer focus than a bare lens. These positive supplementary lenses are not magnifying lenses, but rather a close-up lens designed to change the infinity point of your lens. These lenses feature the unique ability to be used as drop-in devices. When a lens is needed, simply drop the filter in the filter slot of your lens shade system.

These lenses are specifically ground to produce the effect and still be thin enough to fit in the standard 3" filter slot of the shade.

These filters are an ideal companion for wedding photographers. Use with the ring shot, photographs of the invitation, or any other instance where you simply need to get closer than your camera normally permits. They are available in two strengths, +1 and +2. The higher the number, the greater the magnification. No aperture compensation is necessary and small lens openings are recommended for best results.

- Close-up Filter +1 (LICU133) .....67.50**
- Close-up Filter +2 (LICU233) .....67.50**
- Close-up Filter Set (LICU333):** Set of +1 and +2 Close-up Filters. The set includes a Fabric Pouch.....135.00

### Rotating Drop-In Polarizer

Polarizing filters are important to both color and black and white photography. In addition to reducing reflections, polarizing filters will increase color saturation and richness in your photograph. They will regulate reflections from non-metallic surfaces such as water, glass or light from blue skies. The drop-in convenience of the Lindahl system and the features of a polarizer together enable you to create spectacular photographs.

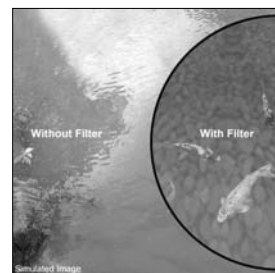

- 3" Linear Type Rotating Drop-In Polarizer (LIP33).....88.95**
- 3" Circular Type Rotating Drop-In Polarizer (LICP33) .....89.95**



**ONE HOUR FREE PARKING**  
AT 349 W. 34th STREET (with purchase of \$100 or more)

# LINDAHL

## PROFESSIONAL FILTERS

### Cross Star Filters

Star filters can add one of the most dazzling effects to your photography. Star effects are created using a filter that flares along a straight line from a specular highlight, point light source or bright reflection. Star Filters have long been a very popular special effect for weddings and portraiture to emphasize dramatic backgrounds. The brighter the light source, the more pronounced the effect. Lindahl achieves this effect with the drop-in rotating mount. Drop-in convenience and adjustability make these filters a requirement for every photographer. By rotating the filter, you can change the orientation of the star and create the effect you need. Increased depth-of-field due to aperture or focal length can diminish the effect. Wide apertures (f5.6-f2) will produce a more pronounced effect.



**4-Point Cross Star (LIS4P33)**  
The 2mm, 4-Point Cross Star produces a brilliant effect with little change in contrast. Spaced at 2mm, the filter produces brilliant stars that do not dominate the scene .....**44.95**

**6-Point Cross Star (LIS6P33)**  
Adds interest and sparkle to your photograph. The lines on this filter are spaced farther apart than the 4-Point to prevent excessive loss of contrast with the increased number of points this filter creates .....**44.95**

## Bracket Plus System and Accessories

### Bracket Plus System for 35mm Cameras (LIBPK35)

The Bracket Plus system is designed to be a complete basic flash bracket system for your camera with a shoe mount type strobe. Designed to be used only with prism finders, the system will allow adapters are available for handle mount type strobes such as Metz, Sunpak, etc. The design of the 35mm base plate allows a Nikon F2 to be opened without removing the camera from the grip. A tripod socket, located on the base plate of all the grip portions, allow you to attach the grip to a tripod or quick release type mechanism, using a 1/4-20 thread.....**149.95**

**Bracket Plus Grip for 35mm Cameras (LIBPG35)**  
Replacement for Bracket Plus System.....**69.95**

**Flash Swing Arm (LISAP5)**  
Replacement for Bracket Plus System. It gives a total of 5" from the top of the grip to the base of the strobe.....**79.95**



**Locking Handle Mount Adapter (LIHMSA)**  
This adapter is required if using a handle mount type strobe on the Bracket Plus or Trigger Grip flash brackets. Simply attach this adapter to the handle of your strobe, slip the adapter into the shoe and tighten in place with the large locking knob .....**64.95**

**Locking Head Mount Adapter (LIHMA3)**  
Allows a Norman or similar strobe head to be positioned correctly for either vertical or horizontal positions on bracket systems. Can also be used as a simple spacer to get your flash in a higher position above the lens .....**34.95**

**Universal Shoe (LIUSGT)**  
Universal aluminum accessory shoe with 1/4-20 thread for mounting. Universal size allows mounting of most popular flash shoe sizes. Ideal for use with the Locking Foot, or flash with locking device.....**9.50**

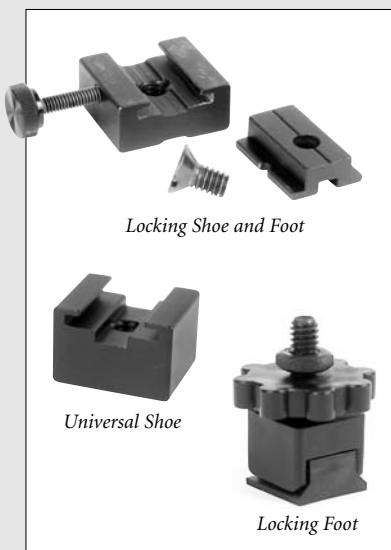

**Locking Shoe and Foot**  
Allows quick mount and release of any accessory that accepts a 1/4-20 thread. Ideal for Norman, Lumedyne, Novatron, Sunpak 120J, Quantum Q-Flash and many others. It is a combination of the Locking Shoe (LILS) and Locking Foot (LIFA).

**Locking Shoe and Foot (LILSF)** .....**19.95**  
**Locking Shoe Only (LILS)**.....**19.95**  
**Locking Foot Only (LIFA)**.....**11.95**

**Locking Foot (LILFGT)**  
Attaches to any 1/4-20 mounting hole. Tighten lock nut against flash, large locking knob tightens foot to any accessory shoe.....**15.95**

# NEWTON BRACKETS

## CAMERA BRACKETS

As photographers move from film to digital there is a need for a camera/flash bracket that offers photographers the ability to hold their camera by the grip with the right hand and support and zoom with the left hand. Newton's Di series camera bracket design allows this freedom. The brackets are made from 6061T aluminum, milled, not bent for strength. The rotator is milled into the design so that you get a solid, secure and stable rotation system for both hand held and tripod photography.

The overhead flash holder on the Di100CR and Di400CR is adjustable. The bracket base has 1/4"-20 tripod socket and holds the camera and flash upright. Each bracket comes with a complete set of hex keys, 1/4"-20 x 1/4" camera plate screw and 1/4"-20 x 1/2" flash screw. (Flash holders must be ordered separately). Newton brackets keep the flash directly over the lens. Newton's patented rotation system and low profile design make a smaller, lighter and stronger bracket with better balance. With a Newton, your camera and flash become a red eye and shadow control system.



### Di100CR Camera Rotator Bracket



If you are using your camera and flash on a tripod as much as hand held the best choice is the Di100CR. This bracket allows the camera to be rotated under the flash without moving

the tripod head. The base on the bottom of the bracket has a 1/4"-20 tripod socket for mounting the bracket on a standard tripod head. Fits most 35mm-type camera bodies without motor drives or booster.

**Di100CR (NED1100CR) .....219.95**

### Di400CR Camera Rotator Bracket

Like the Di100CR, this bracket allows the camera to be rotated under the flash without moving the tripod head. It has a 1/4"-20 tripod socket for mounting on a standard tripod head. The Di400CR is a little larger than the Di100FR but is still small and light enough to give you a well balanced system. Fits all 35mm-type camera bodies with motor drives or boosters.

**Di400CR (NED1400CR) .....209.95**

### Tripod Rotators

The tripod rotator allows the camera to rotate on top of the tripod without moving the tripod head. The lens axis should be as close as possible in both horizontal and vertical positions. To match your camera type with the correct TPR, compare the TPR number with the CR bracket number. The camera combination would be the same.

**Di100TPR Tripod Rotator Bracket (NED1100TPR) .....149.95**

**Di400TPR Tripod Rotator Bracket (NED1400TPR) .....179.95**



### Flash Rotators

If you are mainly hand holding the camera when taking flash pictures then you want the Di100FR or the Di100FR2. SLRs without vertical grips or motors can use Newton's flash rotators. They both rotate the flash around the axis of the lens and keep it over the lens in both horizontal and vertical positions. The flash head is the same in either position allowing bounce flash in either position. Both brackets are small and most photographers leave the FR on their camera when storing but if storage is a consideration, then choose the FR2 because it will fold into a 4x5x1" size to fit in your camera bag.

**Di100FR Flash Rotator Bracket (NED1100FR) .....139.95**

**Di100FR2 Flash Rotator Bracket (NED1100FR2) .....179.95**



# STROBOFRAME

## FLASH BRACKETS

### PRO-RL

Designed for cameras with built-in or accessory grips, the Pro-RL represents a major advance in handling speed and ease of use. It is supported comfortably with your left hand, leaving your right hand free to operate all camera and bracket controls. It is the best bracket to use with a tripod and the use of a cable release is not required.

- ◆ Rotate your camera instantly and effortlessly from vertical to horizontal with a flick of the wrist. In each position, the flash remains centered over the lens, for optimum lighting quality. Fingertip-activated lock secures rotating system in the horizontal position.
- ◆ Exclusive, one-hand TiltTrigger lets you set the flash angle to any of 12 click-stop positions, from close-up to bounce.
- ◆ Unique “kickstand” pivots out and supports and stabilizes the bracket when set on a table or floor.
- ◆ One-handed, instant flash height adjustment. You can position the flash 11 to 18” above the lens, simply by twisting a knob and lifting the flash arm.
- ◆ When the bracket is mounted to a tripod, the flash can be positioned and aimed, and the camera rotated, just as if shooting hand-held.
- ◆ Compatible with cameras with accessory battery packs
- ◆ Integral QR Plate mates with optional QR Receiver, allowing the bracket and tripod to be attached or detached instantly.



Accepts all Stroboframe flash mounts, Camera Anti-Twist Plates and quick release accessories.

STPRL .....124.95

### Camera Flip (STCF)

Compact, lightweight and affordable, the Camera Flip is perfect for travel and convenient for storage in camera bags. Best used with cameras without add-on battery packs, but can be used with cameras who have built-in or accessory grips. The low-profile rotary-link system lets you turn the camera from horizontal to vertical with a flick of the wrist. The flash stays centered above the lens. Includes a machined, shoe-type flash mount, and a cushioned, neoprene foam grip that is comfortable for both shooting and carrying.....64.95



### PRO-T/PRESS-T Lightweight, Professional Brackets

The Pro-T and Press-T are flash-rotating brackets designed for cameras with built-in or accessory grips. Both are light, compact and fast-handling with swinging flash arm to keep the flash centered over the lens for both horizontal and vertical compositions. They don't require a cable release. Unlike most brackets, the Pro-T is designed that you hold the camera rather than the bracket, for more natural shooting. Also allows you to instantly switch between horizontal and vertical compositions. Popular with photojournalists and other shooters who work out of a camera bag, the Press-T is a slightly shorter and more compact version of the Pro-T.

- ◆ Pivoting, machined flash arm keeps the flash centered above the lens for both horizontal and vertical compositions.
- ◆ Integral QR Plate mates to optional QR Receiver, allowing the bracket and tripod to be attached or detached instantly.
- ◆ Pro-T incorporates 3° downward flash tilt for both horizontal and vertical compositions. This improves lighting coverage at typical flash shooting distances.
- ◆ Fully compatible with cameras with accessory battery packs
- ◆ Solid machined aluminum components combine to provide lightweight, superior rigidity and extraordinary balance.
- ◆ Accepts all Stroboframe flash mounts, Camera Anti-Twist Plates and Quick-Release (QR) accessories.

Pro-T (STPT) .....89.95

Press-T (STSP) .....86.95

ORDER & INFO. (212) 502-6340 • FAX: (212) 239-7770 (800) 947-7008  
1-800-290-6750 • www.bhphotovideo.com



FLASHES & ACCESSORIES  
263

# STROBOFRAME

## RL-2000

### Compact, Side-Grip Style Rotary-Link Bracket

Stroboframe's most compact, side-grip style Rotary-Link bracket, the RL 2000 is a traditional-style flash bracket for those who prefer brackets with grips. Very compact and lightweight, it's intended for use with cameras without built-in or accessory grips and that have standard cable-release fittings; a cable-release is included.

- ◆ Rotate your camera instantly and effortlessly from vertical to horizontal with a flick of the wrist. In either position, the flash remains centered over the lens for optimum lighting quality.
- ◆ Dual American walnut grips. The palm grip helps you balance and support the bracket in your hand, while leaving your fingers free for fast focusing. The contoured side grip can be adjusted to any of four positions for maximum comfort.
- ◆ Three-position flash tilt selection for lighting all subjects evenly, particularly in close-ups.
- ◆ A cable release (supplied) attaches to the side grip. It can be adjusted to rest comfortably under your finger.
- ◆ The flash arm can be removed without tools, making the bracket more compact for storage in a camera bag.
- ◆ Bracket base accepts small battery packs, such as the Quantum Battery 1.



- ◆ Optional Low Platform (STCPLPRL2000) is required for use with cameras with larger accessory motor drives or battery packs such as Nikon MB-21 or Canon BP-E1. Replaces standard camera platform.
- ◆ Accepts all Stroboframe flash mounts, Camera Anti-Twist Plates and Quick-Release accessories.

### QUICK FLIP 350 Economical Flash-Rotating Bracket

Quick Flip models offer high value, compact size, light weight and fast handling. Although lower in price than Stroboframe's top-of-the-line brackets, it shares the same quality materials and construction. The Quick Flip 350

accepts all 35mm cameras except those with large, accessory battery packs or motor drives.

Quick Flip 350 (STQF350).....47.95



### STROBOFLIP Ultra-Compact, "Gripless" Flash Rotating Bracket

Stroboflip cradles the camera unobtrusively while maintaining an over-the-lens flash position with a design that lets you hold the camera rather than a grip, and rotate the flash for horizontal or vertical composition. What's more, the stress and weight of the flash unit is transferred from the light-duty camera shoe to the rugged Stroboframe mount. Made for shoe-type flash units.



- ◆ Accepts all 35mm SLR and smaller 6 x 4.5 cameras
- ◆ Supplied with a machined, positive-locking shoe mount and a 35mm Anti-Twist Plate (interchangeable with other AT Plates)

◆ Strong, lightweight aluminum construction with baked-on finish for durability  
Stroboflip (STVH2000).....68.95

### FOLDING FLIP Compact Folding Bracket

The Folding Flip bracket offers high value, compact size, light weight and fast handling. It is an ideal travel bracket that has an extra-wide base and multiple camera mounting slots to accept just about any digital or 35mm camera. The Folding Flip has a height of 9", but conveniently folds down to 8.5 x 3 x 3.75" (LDH), allowing you to carry it in your camera bag or photo vest pocket. The Folding Flip shares the same high quality materials and construction as the other Stroboframe brackets.

Folding Flip (STFF) .....69.95



For Any Inquiries Regarding Your Order, Call Our Customer Service:  
(800) 221-5743 • (212) 239-7765 • FAX: (800) 947-2215 • (212) 239-7549



# STROBOFRAME

## R4B

### Full-size, Professional Rotary-Link Bracket

The standard for those who prefer brackets with full-size, dual grips, the R4B offers a higher flash position than the more compact RL 2000. Made for use with cameras having standard cable-release fittings. A cable release is included with the bracket.

- ◆ Rotate your camera instantly and effortlessly from vertical to horizontal with a flick of the wrist. In either position, the flash remains centered high above the lens for optimum lighting quality.
- ◆ Adjustable camera platform offers full compatibility with cameras with accessory battery packs or motor drives.
- ◆ Continuously variable flash tilt adjustment with friction lock.
- ◆ Dual American walnut grips. The full-size palm grip balances and supports the bracket in your hand while leaving your fingers free for fast focusing. The contoured side grip can be positioned for comfortable eye- or waist-level viewing.
- ◆ A cable release (supplied) attaches to the side grip.
- ◆ Extra-long flash arm folds for more convenient storage.
- ◆ Accepts all Strobiframe flash mounts, Camera Anti-Twist Plates and Quick-Release.



**FLASHES & ACCESSORIES**

**265**

### Camera Auto Quick Release "QRC" Set

Mount and dismount your camera fast. This compact, low-profile quick release automatically docks and locks your camera or bracket to a tripod. The system consists of a QR Receiver mounted to the tripod, and a QR Plate attached to the camera. (Many Strobiframe brackets have an integral QR Plate already built in). Just lower the camera or bracket into the QR Receiver and push down...



your camera is mounted and securely locked into place. To remove the camera or bracket, squeeze the QRC's lever and lift out!

- ◆ The system is fully compatible with all 35mm and medium format cameras, you can use Camera Anti-Twist Plates.
- ◆ QRC systems are available as complete kits, including a QR receiver and/or QR Plate, or, you can purchase the QR Receiver alone for use with Strobiframe brackets that have integral QR Plates. Standard QR Plates are also sold separately.
- ◆ Use the unique QRC Quick-Release system with copy stands for faster, convenient film reloading without disturbing the setup, or for mounting spotting scopes for birding and target shooting. Skydivers even use them to mount cameras on their helmets!

Camera Auto Quick Release "QRC" Set (STQRC) .....56.50

Quick Release Mounting Plate for "QRC" System (STQRP).....14.95

### Flash/Umbrella Bracket for Light Stands

Achieve softer, better studio lighting on location with this versatile bracket. Holds any flash and umbrella and mounts onto any light stand, and its quick, easy adjustments let you position and aim light where you need it. The flash is centered on the umbrella's axis for even light distribution. A standard Strobiframe flash mount is required for shoe or handle-type flash units. A knob is included for mounting flash heads with 1/4"-20 sockets. The ultra-portable Flash/Umbrella bracket works with any light stand, umbrella and flash.

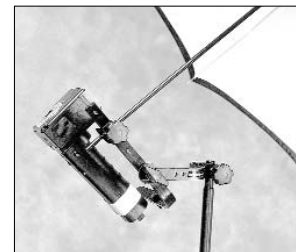

- ◆ Mounts onto any light stand with a mounting stud up to 5/8"
- ◆ Accepts umbrella shafts up to 3/8" diameter.
- ◆ Fully adjustable to maintain flash/umbrella centering.
- ◆ Heavy-duty, aluminum construction with baked-on, non-reflective finish.
- ◆ Large, easy-grip knobs for quick adjustments and secure locking.
- ◆ Folds flat for compact storage.
- ◆ Accepts all standard Strobiframe flash mounts.
- ◆ Supplied with standard 1/4"-20 flash mounting knob for flash units such as Lumedyne or dedicated cords such as the Nikon SC-17.

Flash/Umbrella Bracket (STBFULS).....44.95

### Vertaflip PHD On-Tripod Camera Rotator (STVFPHD)

A convenient tool for rotating your camera horizontally or vertically on a tripod without changing the lens axis. All tripod head controls remain in the same position, letting you concentrate on the subject. You can switch between horizontal and vertical compositions with a simple flick of the wrist. The Vertaflip PHD features a standard 1/4"-20 tripod socket in the base and a 1/4"-20 mounting knob in the camera platform. Heavy-duty, double-link construction assures rigidity, even when using heavy medium format cameras. The Vertaflip accepts optional Anti-Twist Plates and Camera Auto Quick Release.....46.95



**ORDER & INFO. (212) 502-6340 • FAX: (212) 239-7770 (800) 947-7008  
1-800-290-6750 • www.bhphotovideo.com**



# DYNA-LITE

## JACKRABBIT

FLASHES & ACCESSORIES

266

### Power and Performance in a Small Package

A portable power pack for use with on-camera flash units, the Jackrabbit pack is the smallest and lightest (only 31 oz.) high voltage power pack available. Loaded with professional features, the Jackrabbit's compact and lightweight design makes it easy to carry with the supplied belt clip. Compatible with the Dyna-Lite Uni 400JR, supplying it with 75 full-power (320 w/s) flashes per charge without using AC power. Adapter cables are also available for many other manufacturers' flashes such as Nikon, Canon, Minolta, Metz, Sunpak and Vivitar.



DYJR  
\$244<sup>95</sup>

### FEATURES

- ◆ Powerful performance with many 6- and 9-volt flash systems, with fast recycling time and 100% quiet operation
- ◆ Indicators include ready light, battery condition, and Key Mark (visual indicator). A continuous red LED indicates that the battery has dropped below 1/4 of its total charge and should be recharged.
- ◆ Dual high voltage DIN outputs
- ◆ Offers a sturdy belt clip, as well as Double "D" rings for an optional shoulder strap
- ◆ 400 full-power flashes per charge for shoe and handle mount flashes (hundreds more using automatic mode)
- ◆ 75 full power flashes with the Uni400JR
- ◆ Includes a 5-hour charger and it can be recharged in the field or on the way to an assignment. using the optional JR-CAR 12v DC car charger.

### UNI400 JR

#### AC or DC-Powered 400 W/S Monolite

The Uni400 JR weighs just 3.5 lbs. and packs a 400 watt-second wallop. Plugged into an AC outlet you get a fast 1.4 second recycle time at full 400 w/s power. Full, 1/2, 1/4 and 1/8 power settings in 1/3 stop steps provide a four f-stop range. Also features full tracking 100w quartz modeling light, and a built-in optical slave-eye.

Or you can use it on the road, providing the power of studio quality light anywhere, anytime—without an AC power source. Connected to the Jackrabbit high-voltage battery pack, the Uni400 JR can be used anywhere. With a freshly charged pack, you can achieve 75 full-power (320 w/s), 150 half-power and 300 quarter-power flashes.

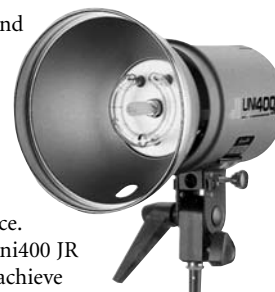

DYU400JR  
\$579<sup>95</sup>

- ◆ Head mount has a 0.5" receptor to accommodate all umbrellas.
- ◆ Stand mount is universal to fit all light stands.
- ◆ Includes UV coated flashtube (P60012), 100w modeling lamp (ESR) and standard reflector
- ◆ Heavy-duty AC power cord and PC to "H" (household) sync cord

### Heavy-Duty, Coiled Hi-Voltage Jackrabbit Cables\* and Accessories

- JR-CZ Cable (DYJRCZ)**  
For Canon 430EZ, 540 EG5CT-1 and CT-5 .....**34.95**
- JR-CL5 Cable (DYJRL5)**  
For Minolta 5200i, 5400xi .....**28.95**
- JR-CM1 Cable (DYJRCM1)**  
For Metz 45CT-1 and CT-5 .....**31.95**
- JR-CM4 Cable (DYJRCM4)**  
For Metz 45CT-3 and CT-4, 45CL-1, CL-3 and CL-4.....**31.95**
- JR-CK Cable (DYJRCK)**  
For Nikon SB-24/25/26/27 .....**29.95**
- JR-CKE Cable (DYJRCKE)**  
For Nikon SB26 Euro, SB28/80DX.....**30.80**

- JR-CS4 Cable (DYJRCS4)**  
For Sunpak AP52, 120J .....**31.95**
- JR-CS5 Cable (DYJRCS5)**  
For Sunpak 411, 511, 522, 544, 555, and 611 .....**29.95**
- JR-CV Cable (DYJRVCV)**  
For Vivitar 283, 3700, 4600, 5200, 5600, 600 Series 1 .....**29.95**
- JR-UNI Cable (DYCU400JRG)**  
For Uni400 JR.....**52.50**
- JR-CAR 12v DC Car Charger (DYCC)**..**53.95**
- JR-CH500 Super Charger (DYCS)** .....**126.50**

\* Flash unit's internal batteries are needed

### Kits



**Dynamite UNIJR-PS1 Kit (DYU400JRRK)**  
Includes a Uni400JR monolight, Jackrabbit battery, charger, AC and DC cables, and grid reflector (no stand or case) .....**819.95**

**Dynamite UNIJR-LW2 Package System (DYU400JRR2K)**  
Includes a 2-Uni400JR monolights, 2 Jackrabbit batteries, charger, umbrellas, light stands and case.....**1934.95**



EQUIPMENT LEASING AVAILABLE

# NORMAN

## P200C/P400B

### Portable 200 W/S and 400 W/S Flash Power Supplies

The battery-operated P200C and P400B are the highest quality 200 and 400 W/S flash power supplies on the market today. They're all-aluminum housings are rugged and compact and they can be worn either over-the-shoulder or around the waist. A high-quality shoulder strap (R4127) with contour pad that hugs the shoulder is available as an option. Remove the pad and the strap ends hook together to hang the pack on a stand or on a door knob. A leather belt (R4122) is also available to wear the P200C or P400B around the waist.

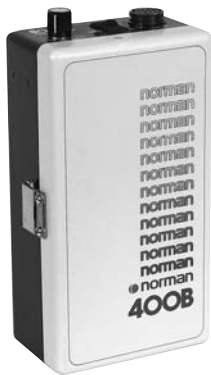

They feature three (P200C) and four (P400B) power levels, quick recycling 1.5- and 3-seconds respectively, voltage stabilized output, quick-change battery, heavy-duty industrial lamphead connector and a low-battery light that warns the photographer when there are only 10 full power flashes remaining. The P200C is powered by the B4124 Super Battery, the P400B by the B5122 Super Battery—which in turn, are charged by the SC Super Charger for added battery life and performance.

The P200C accepts all Norman Series 450 lampheads; LH2K with 5' coil cord (standard), LH2K-M with modeling lamp circuit, LH2 with 20' straight cord and LH2-LS bare bulb lamphead with 3' straight cord. The P400B accepts Norman Series 500 lampheads including the LH52K with 5' coil cord (standard) and LH52K-M with modeling lamp circuit.

#### FEATURES

- ◆ 200 w/s output (P200C) or 400 w/s output (P400B)
- ◆ Up to 190 flashes per charge
- ◆ Flash outputs are digitally adjusted in 1/10th-stop increments over a 6-stop range (5-stops plus full)
- ◆ Three power levels on the P200C; four power levels on the P400B
- ◆ Fast 1.5-second recycling on the P200C; 3-seconds on the P400B
- ◆ Voltage stabilized output
- ◆ Quick-change battery
- ◆ Heavy-duty industrial lamphead connector
- ◆ Low-battery light that warns you when there are only 10 full power flashes remaining
- ◆ The P200C measures 8" x 4" x 2" and it weighs 3.75 lbs
- ◆ The P400B measures 10" x 5" x 3" and it weighs 6 lbs.

**P200C Power Supply (NO200C) .....529.95**

**P400B Power Supply (NO400B) .....619.95**

#### ASSEMBLY KITS

**A200C Assembly Kit (NO200CK):**  
Kit includes LH2K Flash Head; 2D Reflector; P200C power pack; B4124 nicad battery, shoulder strap and SC200CY Super Dual Charger.....**899.95**

**A200CM Assembly Kit (NO200CMK):**  
Kit includes LH2KM Flash Head; 2D-ML Reflector; P200C power pack; B4124 nicad battery, shoulder strap and SC200CY Super Dual Charger.....**959.95**

**A400B Assembly Kit (NO400BK):**  
Kit includes P400B power supply, LH52K Flash Head; 2D Reflector; two B5122 Super Batteries, SC400B Super Charger and a shoulder strap .....**1077.95**

**A400BM Assembly Kit (NO400BMK):**  
Kit includes P400B power supply, LH52KM Flash Head; 2D Reflector; two B5122 Super Batteries, SC400B Super Charger and a shoulder strap .....**1129.95**



# NORMAN

## BATTERIES & CHARGERS



### Batteries

The Super Batteries provide the P200C and P400B with over 190 full-power flashes per charge with no memory effect and dramatically long battery life.

**NiCad Battery for P200C (NOB200C)**  
Provides 190+ full power flashes at 10-second intervals .....104.95

**NiCad Battery for P400B (NOB400B)**  
With two Super Batteries installed, the P400B provides 190+ full power flashes at 15-second intervals .....ea. 114.95

### Chargers

The Super Charger is a state-of-the-art battery charger for charging two Norman 12v nicad batteries simultaneously, including the B4124 and B5122 Super Batteries. It obtains a complete charge without heating the battery cells. Charge time from dead-to- full is about 3-hours. Shorter charge times will be noticed if the batteries have some charge left in them when placed on the charger.

**SC Super Charger (NOSC)**  
For P200C/P400B .....249.95

**SC-200C Super Charger with R5002 Cable (NOSC200C)**  
For use with the 200C Power Supply...259.95

**SC-200CY Super Charger with R5005 "Y" Cable (NOSC200CY)**  
For use with two 200C's .....279.95

**SC-400B Super Charger with R5003 Cable (NOSC400B)**  
For use with the P400B's .....289.95

**Dual External Battery Charging Tub (NOT200C)**  
Simplifies battery maintenance, by allowing you to charge one or two B4124 batteries at the same time. Connects to the Super Charger .....63.00

**R5002 200C Charge Cable (NOCC200C)**  
Connects Super Charger to 200C 3-pin charger outlet .....15.95

**R5005 200C "Y" Charger Cable (NOYC200C)**  
Connects the Super Charger to the 3-pin charger outlets on two 200C Power Packs .....40.95

**R5003 400B Charging Cable (NOCC400B)**  
Connects the Super Charger to 400B lamphead connector .....31.95

**R5006 400B "Y" Charging Cable (NOYC400B)**  
Connects the Super Charger directly to two B5122 batteries .....40.95

**R5201 12v Auto "Cigarette Lighter" Charger Power Cable (NOCLCC200C)**  
Connects the Super Charge to a 12v power source .....19.95

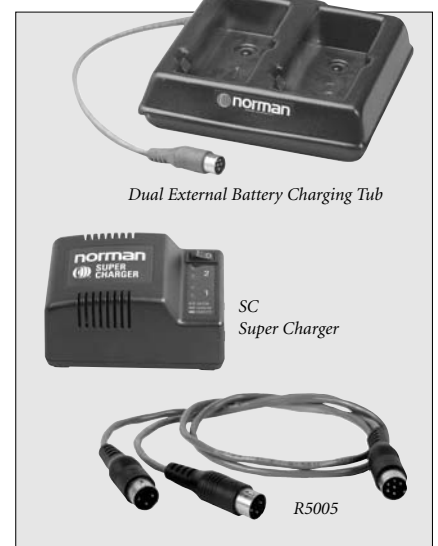

**R4127 Contour Shoulder Strap (NOR4127)**  
For use on the P200C and 400B. Remove the pad and the strap ends hook together to hang on a stand .....26.50

**R4122 Leather Waist Belt (NOCABPPP)**  
Can be used with the P200C and P400B NiCad batteries .....26.75



### Softboxes

Get quality softbox lighting from your battery portable flash system. Designed for Norman LH2 and LH52 portable heads, the 12" square SSB12-BP and the 19" octagonal OSB19-BP can also be used on most Quantum Q Flash and Lumedyne lampheads. Much like the Norman Studio Softbox design, these units "pop-up" like an umbrella. No loose parts or assembly required, except for the removable front diffusion panel that attaches with Velcro. No speed ring adapter is required. Each Softbox attaches to the lamphead like a standard reflector. On Norman lampheads, just position over the flashtube and tighten the reflector locking screw.

**12" Square Softbox for Battery Powered Flash Heads (NO12SBBP) .....37.95**  
**19" Octagonal Softbox for Battery Powered Flash Heads (NO19OSB) .....39.95**



For Any Inquiries Regarding Your Order, Call Our Customer Service:  
(800) 221-5743 • (212) 239-7765 • FAX: (800) 947-2215 • (212) 239-7549

# NORMAN

## LAMPHEADS

### 200 W/S Portable Lampheads\*

**LH2 UV Flash Head with 20' Cable (NOLH2)**  
A lightweight, extremely portable head that has recessed controls to prevent accidental flashing. It includes an FT120-UV plug-in flashtube with UV filtration and a 20' cable. A standard 1/4-20 threaded hole on the bottom gives you endless mounting options. Use the R4108 and R4130 Umbrella Stand Adapters to attach it to a light stand ....**159.95**

**LH2K UV Flash Head with 5' Coiled Cord (NOLH2KQ)**  
The LH2K is the same as the LH2, except it comes with a 5' coil cord with a vinyl jacket that won't crack or split .....**149.95**

**LH2KM UV Flash Head with 5' Coiled Cord (NOLH2KMQ)**  
Same as above, except it also features a 12v modeling lamp circuit that automatically switches off after each flash or after 20 seconds, whichever comes first. This prevents draining of the battery .....**255.00**



\*Lampheads don't include a reflector

**R4101 Camera Bracket (NOBC)**  
Mount the LH2 and LH52-type lampheads to any 35mm camera at a height that prevents "red-eye" .....**84.50**

### 400 W/S Portable Lampheads\*

**LH52 Flash Head with 20' Cable (NOLH52)**  
Designed for use with the P400B, the lightweight LH52 includes an FT400-UV plug-in flashtube with UV filtration and a 20' cable. Standard 1/4-20 threaded hole on the bottom gives you endless mounting options. Use the R4108 and R4130 Umbrella Stand Adapters to attach the LH52 to a light stand.....**179.95**

**LH52K Flash Head with 5' Coiled Cord (NOLH52K)**  
The LH52K is the same as above, except it comes with a 5' coil cord with vinyl jacket that won't crack or split.....**182.00**

**LH52KM Flash Head with 5' Coiled Cord (NOLH52KM)**  
LH52KM is the same as above, except it also features a 12v modeling lamp circuit. The modeling lamp circuit automatically switches off after each flash or after 20 seconds, whichever comes first. This prevents draining of the battery.....**249.95**

FLASHES & ACCESSORIES

269

## REFLECTORS

**2D: 5" Standard Reflector Lampheads:**  
5" general purpose reflector accepts all Norman 5" barndoors, grids, filters and R9111 reflector cover. Used on LH2 and LH52 heads.  
**For LH2 Heads (NOR5LH2K).....19.95**  
**For LH52 Heads (NOR5LH52K).....19.95**

**2D-ML: Standard Reflector with Modeling Lamp:**  
5" reflector with 50w quartz modelling lamp.  
**For LH2 Heads (NOR5MLLH2KM) .....39.95**  
**For LH52 Heads (NOR5MLLH52KM).....39.95**

**2D-RP: White Reflector with Frosted Diffusion Dome**  
A 5" 120° soft diffused wide angle reflector with a built-in permanent frosted glass diffusion dome.  
**For LH2 Heads (NOR5DDLH2K) .....36.95**  
**For LH52 Heads (NOR5DDLH52K).....36.95**

**2DRP-ML: White Reflector with Modeling Lamp**  
A 5" 120° soft diffused wide angle with 50w quartz modeling lamp.  
**For LH2 Heads (NOR5DDMLLH2K).....64.95**  
**For LH52 Heads (NOR5DDMLLH52).....64.95**

**2Q: 6" Reflector with 150 watt/115 Volt AC Modeling Lamp**  
Converts the 200C or 400B into a studio system. Ideal for umbrella use. Requires an R4153 AC extension cable for the modeling lamp, but not needed on AC-operated power supplies.  
**For LH2 Heads (NOR6LH2K).....52.00**  
**For LH52 Heads (NOR6LH52K).....52.00**

**2H: 8" Reflector with R4112 Optical Spacer**  
8" reflector has a mirror surface and R4112 optical spacer, and provides a long throw for use with telephoto camera lenses in sports, news or wildlife applications.  
**For LH2 Heads (NOR8LH2K).....66.95**  
**For LH52 Heads (NOR8LH52K).....66.95**

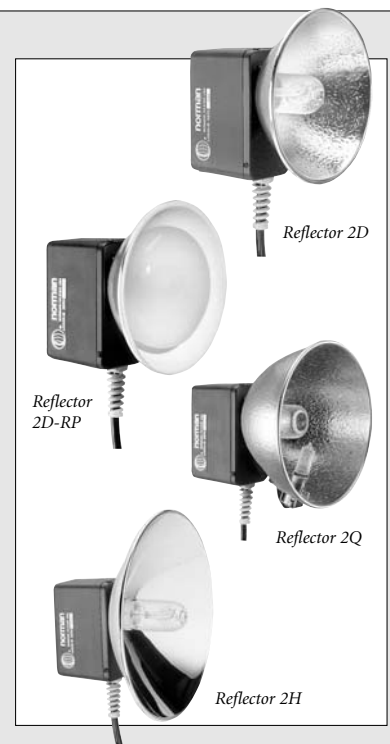

ORDER & INFO. (212) 502-6340 • FAX: (212) 239-7770 (800) 947-7008  
**1-800-290-6750 • www.bhphotovideo.com**



# LUMEDYNE

## NEXT GENERATION SERIES

FLASHES & ACCESSORIES

270

### Power Packs

Incorporating over thirty years of proven technology together with modern manufacturing, Lumedynes 'Next-Generation Power Packs' are their best high power flash systems ever. The natural evolution of the existing Lumedyne system, the Next-Generation packs are backward compatible with boosters, high speed modules, chargers and flash heads. Existing heads plug directly into the pack, while the Next Generation heads use an extension cord or head cable to plug into the pack. The packs offer similar controls, a 7 LED light battery gauge and 4 f-stops of manual control through one or two flash heads. 7 f-stop control is possible with an optional Auto Module. Packs are straightforward and simple to operate with one main control and an On/Off button for the battery gauge.

Available in 200 or 400 w/s packs, one or two flash heads may be used in manual without needing extra adapters. Very low power settings help with faster film speeds, digital cameras and confined spaces, and conserve battery power. They include a full two-year warranty and are powered via battery, AC power supply or car adapter.



### FEATURES

- ◆ They have two Lumedyne-style head jacks, so power is symmetrically divided if two heads are used.
- ◆ You can use Auto Modules to control the flash heads individually in manual or automatic with seven f-stops of control.
- ◆ 100% charge recycle indication lights up during recycling and goes out when the pack has achieved 100% charge.
- ◆ Recycling time can be reduced with high-speed modules
- ◆ A variety of AC adapters are available for use in the studio and in your vehicle.
- ◆ For power and flexibility add on 200 w/s or 400 w/s booster modules up to a total of 2400 w/s.
- ◆ Optional booster modules also have a separate power switch that enables you to vary the power distribution between the different flash heads.
- ◆ Threaded inserts (pre-tapped holes) allow a belt clip or any other accessory to be installed easily.
- ◆ They include an Op-Tech shoulder strap
- ◆ Compatible with the Classic and Signature Flash Heads, batteries and accessories
- ◆ While not waterproof, they are splash and rain resistant.



### P2NF

#### 200ws Next Generation Power Pack with Fast Recycling

- ◆ 25ws in 0.4 sec., 50ws in 0.7 sec., 100ws in 1.3 sec. and 200ws in 2.5 sec.
- ◆ 4 f-stops with settings at 25ws, 50ws, 100ws and 200ws
- ◆ Seven light LED battery gauge at a touch of a button
- ◆ Directly accepts the Quantum QFX head

LUP2NF.....479.95

### P2NX

#### 200ws Next Generation Pack with X-Tra Fast Recycling

The same as the P2NF except it recycles twice as fast every flash— 25ws in .2 sec., 50ws in .4 sec., 100ws in .7 sec. and 200ws in 1.3 seconds (can't use small batteries).

LUP2NX .....567.95

### P4NF 400ws Next Generation Pack with Fast Recycling

- ◆ 50ws in 0.7 second, 400ws in 5 seconds
- ◆ Four f-stops of control with settings at 50ws, 100ws, 200ws and 400ws
- ◆ Seven light LED battery gauge at a touch of a button

LUP4NF.....624.95

### P4NX 400ws Next Generation Pack with X-Tra Fast Recycling

The same as the P4NF except it recycles twice as fast every flash—50ws in 0.4 second, 400ws in 2.5 seconds (X-Tra Fast Packs cannot use small batteries)

LUP4NX.....689.95



# LUMEDYNE

## NEXT GENERATION SERIES

### Flash Heads

The flash heads are electronically able to handle 2400ws (they are only limited by the 800ws or 2400ws Quartz Flashtube in the head). They have a round shape, 1/4-20 threaded mount, and have an ultra lightweight PVC plastic body. This makes them popular for camera bracket mounting.



These Heads are compatible with all generations and styles of Lumedyne Power Packs. There are no TTL Connections on these Heads only dual sync connections (1/8" mini-phone and household). Next Generation Flash Heads can be customized to have TTL compatible connections for Quantum or Metz TTL Modules (but they will be longer and notably more expensive.)

You must have a Lumedyne TTL compatible Power Pack to utilize TTL features and original Quantum or Metz TTL modules and cables. Lumedyne Heads are not E-TTL or D-TTL compatible because of pre-flash light metering requirements.

Heads include two densities of Diffusers, a metal Snoot, Guide Cards, a two-position reflector, 25 watt Modeling Bulb and 800ws UV or 2400ws Quartz UV Flashtube.

Heads are available with a built-in 5' straight or 3-to 7' coiled, or a pig-tail cable option for those who want to use Auto Modules or just remove the separate head cable for transportation.

**800 W/S Flash Head (LUHERS):** With modeling light and 5' straight head cable.....**219.95**

**2400 W/S Flash Head (LUHQRS):** With modeling light and 5' straight head cable.....**322.95**

**800 W/S Flash Head (LUHERC):** With modeling light and 3-7' coiled head cable.....**258.95**

**2400 W/S Flash Head (LUHQRC):** With modeling light and 3-7' coiled head cable.....**338.95**

**800 W/S Flash Head (LUHERN):** No head cable, with pig-tail connector\*.....**213.95**

**2400 W/S Flash Head (LUHQRN):** No head cable, with pig-tail connector\*.....**315.95**

\* Five Head Cables are available from 18" to 20', or use a Head Cable from the Pack to an Auto Module then connect it to the Head.

### Action Series

*Action Packs are ideal for those photographers need a high power flash with a very short flash duration. This allows faster shutter speeds and will produce sharper images of fast action much better than a normal flash of similar power.*



◆ Action Series packs are designed for extreme sports, rodeo, racing, scientific and nature photographers who need to stop action that is not very close to them. These packs will not freeze a bullet fired from a gun. The tips of a hummingbird's wings may still show very slight motion. They are the most effective at the highest settings because that is four times faster than a normal flash at that power. At half power, they are twice the speed of a normal flash of similar power. At the lowest setting, they are equal to Lumedyne's normal flash duration for that power.

◆ The Action Packs will flash at all three power levels with the same fast flash duration. Normally, to double the power required to reach the next f-stop, a flash lasts twice as long. These packs actually get twice as bright for the same flash duration. Each pack can double up this way to provide three power settings. Each Pack has one head jack and a battery gauge. A weight reduction Op-Tech shoulder strap is included.

◆ The X-tra fast recycling times of these packs require a Medium Battery or larger for best performance. The 200ws recycle time is only 1.3 seconds, 2.5 seconds for 400ws. High Speed Modules can be used to provide even faster recycling if you have Extra Large Batteries.

◆ Action Packs will NOT work Booster Modules, and AC power supplies, as well, must not be used with them. The Vehicle Adapter works fine if you have a 30 amp fuse in-line to your cigarette lighter, those are normally 15 amp from most car companies.

◆ While the Action Packs are compatible with all Lumedyne Flash Heads, the 2400ws Quartz Flashtube is required for the 400ws P4XX and recommended for the 200ws P2XX. No other brand of flash head or Auto Module should be used with the Action Packs. The guide number of the light output is about equal to Lumedyne's normal flash systems, it just happens much faster.

◆ Some cameras can sync with a flash at faster shutter speeds, but that could cut off some of the light output from a high power flash. These packs allow you to cut down the ambient light with your faster shutter speed without cutting off the end of the flash illumination.

#### P2XX (LUP2XX)

200ws Power Pack with X-tra fast flash duration and X-tra fast recycling —three f-stops with 50ws – 100ws – 200ws. All with 1/3000 second flash duration.....**648.95**

#### P4XX (LUP4XX)

400ws Power Pack with X-tra fast flash duration and X-tra fast recycling —three f-stops with 100ws – 200ws- 400ws. All with 1/1500 second flash duration.....**768.95**

# LUMEDYNE

## SIGNATURE SERIES

FLASHES & ACCESSORIES

272

### Power Packs

Stepping up from the Next Generation power packs, the Signature Series power packs each offer 7 f-stops of manual control and have 4- or 7-LED light power gauges. Their very low power settings make them ideal with fast speed film and confined spaces, as well as for saving power. All Signature Series power packs, flash heads and modules include a 2-year warranty. Packs are available with 200ws or 400ws in 'Basic' or 'Deluxe' version with fast or 'x-tra' fast recycling. Adapters are available to run the Quantum Q-flash X2 up to 400ws.

The Deluxe Packs offer the same versatility with a seven light battery gauge and a TTL setting with optional audible confirmation. TTL is accomplished by using Metz brand SCA TTL adapters plugged into a Deluxe Flash Head. The Deluxe Packs also offer a Manual Trim Control to go variably down to the next manual f-stop. One or two flash heads may be used in manual or TTL without needing extra adapters. TTL functions up to 2400 w/s with boosters added.



### FEATURES

- ◆ They have two Lumedyne-style head jacks, for full power to one head or symmetrical power to two heads
- ◆ Seven f-stop range (3ws to 200ws; 6ws to 400ws with indicators)
- ◆ Four light battery gauge with On/Off button
- ◆ OK, Boost and Ready indicators
- ◆ Reinforced side panels
- ◆ You can use Auto Modules to control the flash heads individually in manual or automatic with seven f-stops of control.
- ◆ 100% charge recycle indication lights up during recycling and goes out when the pack has achieved 100% charge.
- ◆ Recycling time can be reduced with high-speed modules
- ◆ Powered by four sizes of batteries all with 100-month Pro-rate warranties, as well as a variety of adapters for use in the studio and in a vehicle.
- ◆ For power and flexibility add on 200 or 400 w/s booster modules up to 2400 w/s.
- ◆ Optional booster modules also have a separate power switch that enables you to vary the power distribution between the different flash heads.
- ◆ Threaded inserts (pre-tapped holes) allow a belt clip or any other accessory to be installed easily.
- ◆ They include a shoulder strap
- ◆ Splash and rain resistant
- ◆ 2-year warranty

### Basic Packs

- 200ws Signature Series Basic Power Pack with X-tra Fast Recycling (LUP2BX)**  
Seven f-stops from 3ws to 200ws, full recycle in 1.3-sec. Only accepts medium to large-size batteries.....**698.95**
- 400ws Signature Series Basic Power Pack with Fast Recycling (LUP4BF)**  
Seven f-stops from 6ws to 400ws, full recycle in 5-Sec. Use any size battery .....**744.95**
- 400ws Signature Series Basic Power Pack with X-tra Fast Recycling (LUP4BX)**  
Same as the P4BF except it recycles twice as fast — full recycle in 2.5 Sec. Only accepts medium to large-size batteries .....**834.95**

### Deluxe Packs Step-up Features

- ◆ Trim Control allows you to adjust Manual power between f-stop settings with indicator
- ◆ Volume control for audible TTL confirmation with indicator
- ◆ Head jacks also accept two TTL Heads without extra adapters
- ◆ Seven LED light battery gauge with On/Off button
- ◆ OK, Boost, Ready and TTL indicators

### Deluxe Packs

- 200ws Signature Series Deluxe Power Pack with X-tra Fast Recycling (LUP2LX)**  
Seven f-stops from 3ws to 200ws, full recycle in 1.3-sec.. Only accepts medium to large-size batteries.....**798.95**
- 400ws Signature Series Deluxe Power Pack with Fast Recycling (LUP4LF)**  
Seven f-stops from 6ws to 400ws, full recycle in 5-Sec. Use any size battery .....**844.95**
- 400ws Signature Series Deluxe Power Pack with X-tra Fast Recycling (LUP4LX)**  
Same as the P4LF except it recycles twice as fast —full recycle in 2.5 Sec. Only accepts medium to large-size batteries.....**934.95**



**EQUIPMENT LEASING AVAILABLE**



# LUMEDYNE

## SIGNATURE SERIES

### Flash Heads

Signature Series Flash Heads are strong enough to support large softboxes, yet light enough to be hand carried on a bracket. They have a green ready light next to the test fire button to show when they are ready. Weather resistant, the heads can be powered up to 2400 w/s limited only by the flashtube. Sync via the H-Plug or mini phono sync jack. A switchable 25w modeling light is standard. An indicator on the back of the head lights up when the modeling light is on.

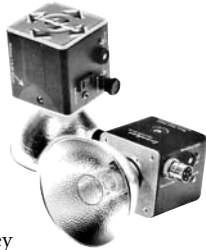

- ◆ UV coated flashtube provides accurate color rendition.
- ◆ User replaceable — no tools are required to replace this “plug and play” flashtube.
- ◆ 1/4”-20 thread enables easy mounting on a camera bracket, light stand or tripod.
- ◆ A test fire button lets you fire the strobes when the pack may be out of reach.
- ◆ Metal frame makes them the strongest portable flash heads
- ◆ Knurled knob to adjust reflectors and accessories
- ◆ Two-position reflector (normal and W/A)
- ◆ A Lumedyne head cable is needed to connect the head to the power pack. 5, 10 or 20’ straight or 3-7’ coiled cable is available.

**800 w/s Flash Head (LUHEBC) .....229.95**

**2400 w/s Flash Head (LUHQBC).....304.95**

### Deluxe Heads (Step-up Feature)



These heads have options for either Quantum or Metz SCA TTL modules and an Audible Recycle Indicator with volume control.

**Deluxe 800 w/s Flash Head (LUHEDM)  
For Metz.....274.95**

**Deluxe 800 w/s Flash Head (LUHEDQ)  
For Quantum.....274.95**

**Deluxe 2400 w/s Flash Head (LUHQDM)  
For Metz.....384.95**

**Deluxe 2400 w/s Flash Head (LUHQDQ)  
For Quantum.....384.95**

### COMPLETE KITS



### 200ws LumeKits

#### Next Generation

##### X-tra Fast 200 w/s Kit

Includes: P2NX 200ws X-Tra Fast Power Pack, HERC 800ws Flash Head, Coiled Cable, BMED Medium Battery, CQ1U Quick Trickle Charger, ASC1 Sync Cord (LUZKN3) .....**1024.95**

##### Action Pack 200 w/s Kit

Includes: P2XX 200ws X-tra Fast Power Pack, HQRC 2400ws Flash Head, Straight Cable, BMED Medium Battery, CQ1U Quick Trickle Charger, ASC1 Sync Cord (LUZKX2) .....**1084.95**

#### Signature Series

##### Basic X-tra Fast 200 w/s Kit

Includes P2BX 200ws Basic X-tra Fast Power Pack, HEBC 800ws Flash Head, HCCD 7’ coiled cord, BMED Medium Battery, CQ1U Quick Trickle Charger, ASC1 Sync Cord (LUZK24).....**1244.95**

#### Signature Series Deluxe

##### X-tra Fast 200 w/s Kit (w/Metz)

Includes P2LX 200ws X-tra Fast Deluxe Power Pack, HEDM 800ws Signature Deluxe SCA Metz TTL Flash Head, HCCD 7’ coiled cord, BMED Medium Battery, CQ1U Quick Trickle Charger, ASC1 Sync Cord (LUZK26).....**1387.95**

##### Signature Series Deluxe X-tra Fast 200 w/s Kit (w/Quantum)

Includes P2LX 200ws X-tra Fast Deluxe Power Pack, HEDQ 800ws Signature Deluxe SCA Quantum TTL Flash Head, HCCD 7’ coiled cord, BMED Medium Battery, CQ1U Quick Trickle Charger, ASC1 Sync Cord (LUZK27).....**1387.95**

Each kit comes with a Pack, Head, Battery, Charger, Head Cable, Sync Cord, 2 Diffusers, Snoot, and Guide Cards.

### 400ws LumeKits

#### Next Generation Fast 400 W/S Kit

Includes: P4NF 400ws Fast Power Pack, HERS 800ws Flash Head, Straight Cable, BSML Small Battery, CT1U Single Trickle Charger, ASC1 Sync Cord (LUZKN4) .**984.95**

#### Next Generation

##### X-tra Fast 400 W/S Kit

Includes: P4NX 400ws X-Tra Fast Power Pack, HERC 800ws Flash Head, Coiled Cable, BMED Medium Battery, CQ1U Quick Trickle Charger, ASC1 Sync Cord (LUZKN5) .....**1154.95**

##### Action Pack 400 W/S Kit

Includes: P4XX 400ws X-tra Fast Power Pack, HQRC 2400ws Flash Head, Straight Cable, BMED Medium Battery, CQ1U Quick Trickle Charger, ASC1 Sync Cord (LUZKX4).....**1204.95**

#### Signature Series

##### Basic Fast 400 W/S Kit

Includes: P4BF 400ws Basic Fast Power Pack, HEBC 800ws Flash Head, HCST 5’ straight extension cord, BSML Small Battery, CT1U Single Trickle Charger, ASC1 Sync Cord (LUZK40) .....**1164.95**

#### Signature Series

##### Basic X-tra Fast 400 W/S Kit

Includes P4BX 400ws Basic X-tra Fast Power Pack, HEBC800ws Flash Head, HCCD 7’ coiled cord, BMED Medium Battery, CQ1U Quick Trickle Charger, ASC1 Sync Cord (LUZK44).....**1354.95**

#### Signature Series

##### Deluxe Fast 400 W/S Kit

Includes P4LF 400ws Deluxe Fast Power Pack, HEDM 800ws Flash Head, HCCD 7’ coiled cord, BSML Small Battery, CQ1U Quick Trickle Charger, ASC1 Sync Cord (LUZK42) .....**1349.95**

FLASHES & ACCESSORIES

273

**ORDER & INFO. (212) 502-6340 • FAX: (212) 239-7770 (800) 947-7008  
1-800-290-6750 • www.bhphotovideo.com**



# LUMEDYNE

## QUADRAMATIC SERIES

### 400 w/s Power Pack

This full power 400ws Power Pack with X-tra Fast recycling times is made to be used with a power control Head like the Quantum X series Q-Flash Heads or any of Lumedyne's Heads used with an Auto Module for power control. The simplicity of this pack is that there is no power level switch to accidentally have in the wrong power setting. Less parts make it slightly less expensive than a similar pack with power control, but also has less components that could possibly fail or malfunction. It has an On/Off switch and a battery gauge, that's it. The pack only needs to be turned "On", there are no power options but you can always check the strength of the battery currently connected. Includes an Op-Tech Shoulder Strap.



- ◆ Designed for those who always shoot full power, like team sports images for example
- ◆ One of the head jacks is directly compatible with the Quantum Q-Flash X, X2 or X2D Flashes. As a raw power source for the QFX Heads, all of Quantum's TTL and Digital TTL features function normally.
- ◆ Quantum QFX Heads also offer automatic and manual control with push button control in third f-stops. (Remember that the Quantum Heads are limited to 400ws!)
- ◆ The other head jack is Lumedyne's normal style which can also be used at full power with any Lumedyne Flash Heads.
- ◆ With Lumedyne's Auto Modules you can control the power via seven f-stop settings in either Manual or Automatic Power.
- ◆ Lumedyne's Auto Modules and Flash Heads can be boosted up to 2400ws provided you have a Quartz Flashtube.
- ◆ The Auto Modules have built-in light sensors and need only be pointing at the subject while the Head can be bare bulb or in a light modifier or reflecting off anywhere within reach of Extension Head Cords. Confirmation lights let you know if you have enough power for the desired f-stop.
- ◆ Imagine having a stand with a pack and battery clamped at the bottom, an Auto Module mounted in the middle looking at your subject and a lightweight Head on top with a light modifier for professional results. Just aim, choose an f-stop and shoot. With a radio slave, it is completely wireless and secure from the errant flashes a slave produces when others take pictures.

### P4QX

- ◆ 400ws Quadramatic Power Pack with X-Tra Fast Recycling (2.5 seconds at 400ws)
- ◆ The same as the P4QF except it recycles twice as fast for every flash. X-Tra Fast Packs cannot use small batteries

LUP4QX .....598.50

### Optional Flash Tubes and Modeling Bulbs

Modeling flashtubes have a circular design that casts a slightly wider (and more even) distribution of light than conventional tubes, which is why modeling heads have 1/2 f-stop lower guide numbers. Modeling flashtubes will fit any Lumedyne head, but the modeling light itself is only available in modeling heads. Standard flashtubes fit only the standard heads, and produce the maximum light output per w/s because the angle of coverage is slightly lower.

#### 800 w/s UV Tinted Flashtube for Standard Head (LU097V)

Standard flashtubes fit only the Standard heads, and produce the maximum light output per w/s because the angle of coverage is slightly lower.....49.95

#### 800 w/s UV Tinted Flashtube for Modeling Head (LU093V)

This is one of the most common flashtubes included in the modeling heads - the front of the yellow UV coated glass dome is open to vent the heat from the modeling light.....49.95



#### 2400 w/s Quartz Flashtube for Standard Head (LU097Q)

This is a plug-and-play flashtube that will handle a maximum of 2400 w/s, and will fit standard "Classic" Lumedyne flash heads .....153.95

#### 2400 w/s Quartz Flashtube for Modeling Head (LU093Q)

Fits any head and handles up to 2400 w/s - Quartz helix can handle the extreme power and heat and is protected with a wrap around UV tinted dome .....142.95

#### Spare 25W Bulb for Modeling Heads (LU095)

The separate small glowing bulb mounted in the center of the modeling flashtubes ....16.95



# LUMEDYNE

## HAHM

### Auto Exposure Handle Module for Lumedyne Flash Heads

Now you can also control the exposure of any head with its own Auto Module—up to 2400ws. Shaped like a fat handle for a strobe, the HAHM Auto Exposure Handle has seven manual settings and seven auto settings all of which can be trimmed in between settings for exact exposures. Manual power above 200ws is controlled by the power pack. Automatic power is controlled by the HAHM up to 2400ws. Head Cables are used to connect to both the pack and the head. You can use Head Cables to mount the Head away from the auto sensor and control panel. This is handy in order to use light modifiers or go off camera while the sensor and controls stay near the camera.

- ◆ Seven manual f-stops with trim control between f-stops from 3ws-200ws
- ◆ Automatic exposures between 3ws and 2400ws with trim control between 7 f-stops
- ◆ 1/4-20 threaded mounts on the top and bottom allow for various mounting techniques
- ◆ Test fire, OK confirmation and sync connection



**Autoexposure Handle Module**  
(LUHAHM).....256.50

FLASHES & ACCESSORIES

275

### Head Cables (Can be used directly to a Flash Head or as an Extension Cord)

- HCST:** 5' straight cord with male and female Lumedyne connectors (LUHCST) .....46.80
- HCCD:** 3-7' coiled with male and female Lumedyne connectors (LU035) .....57.95
- HC10:** 10' straight with male and female Lumedyne connectors (LU036) .....49.95

- HC20:** 20' straight with male and female Lumedyne connectors (LU032) .....58.50
- HCA1:** 1' straight cord with male and female Lumedyne connectors. Used as an extension cord for an Auto Module on a camera bracket (LUHCA1).....39.95

- HFTX:** Plugs into the head where the flash-tube normally goes and extends the flash-tube to the end of the 5' cable (LU037) ....66.95
- HAQQ:** Adapts the Lumedyne-style head jack on a pack to a Quantum-style connector for the QFX heads (LUHAQQ) .....35.10

### Booster Modules

Booster modules add extra power to your system. When you double the w/s (watt/seconds), you gain one f-stop (200ws to 400 ws) and get half as many flashes per charge. Boosters only effect the highest setting on a power pack. They are available in 200ws or 400ws levels. Deluxe boosters have additional asymmetrical flash head jack(s). The 200ws Deluxe Booster has one extra head jack controllable at 100 or 200ws or send the boost up to the Pack. The 400ws Deluxe Booster is like two of the 200ws Deluxe Boosters in one box and has two individually controlled head jacks.



#### **X2BC** (LU071A)

200ws of additional power when it is stacked between the battery and power pack. On/Off switch for the additional boost power. Can be stacked with other boosters .....171.00

#### **X2DL** (LU072)

200ws of additional power stacked between the battery and power pack. One head jack. Send the power up to the pack or 200ws/100ws to head jack on the booster. Can be stacked with other boosters for more options. Can be used on AC alone ..202.00

#### **X4BC** (LU073)

400ws of additional power when it is stacked between the battery and power pack. On/Off switch for the additional boost power. Can be stacked with other boosters .....299.95

#### **X4DL** (LU074)

400ws of additional power stacked between the battery and power pack. Two head jacks. Send some or all of the power up or divide symmetrically between the head jacks. Can be stacked with other boosters. Can be used on AC alone.....339.95

**ORDER & INFO. (212) 502-6340 • FAX: (212) 239-7770 (800) 947-7008  
1-800-290-6750 • www.bhphotovideo.com**



# LUMEDYNE

## POWER PACK ACCESSORIES

FLASHES & ACCESSORIES

276

### Batteries for Power Packs

Lumedyne batteries all carry an 8-year pro-rated performance guarantee. The PEPI protects the battery and gives you a full charge indication while on charge. In addition, there is no memory problem so you can charge them when you want without having to run them down. Batteries are proportional in size, weight, performance and cost.

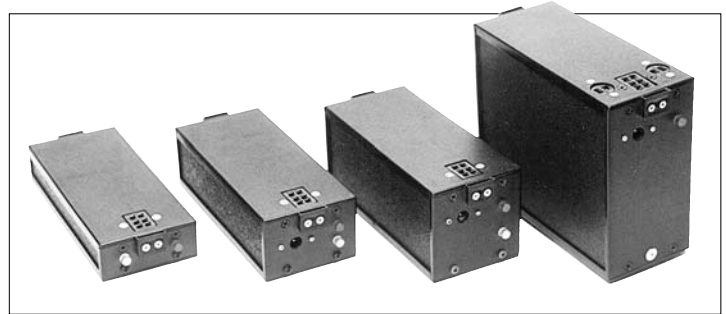

#### BSML Small Battery (LU024C)

100 flashes at 200ws, 6-hour Trickle Charge, 3-hour Quick Charge, 2-hour Ultra Charge. (Not for use with X-Tra Fast recycling Power Packs or High Speed Modules) .....**109.95**

#### BMED Medium Battery (LU025C)

200 Flashes at 200ws, 12-hour Trickle Charge, 6-hour Quick Charge, 4-hour Ultra Charge (can be used with any recycling speed Power Packs, not for High Speed Modules) .....**174.95**

#### BLRG Large Battery (LU026CK)

300 Flashes at 200ws, 18-hour Trickle Charge, 9-hour Quick Charge, 6-hour Ultra Charge (can be used with any recycling speed Power Packs and for Fast High Speed Modules) .....**249.95**

#### BXLG X-Large Battery (LU028CK)

600 Flashes at 200ws, 18-hour Quick Charge, 12-hour Ultra Charge, (not suitable for Trickle Charge). Can be used with any recycling speed Power Packs—required for X-Tra Fast High Speed Modules .....**476.00**

#### BGPA Battery Gauge and Power Adapter Module (LUBGPA)

Use the Battery Gauge and Power Adapter to test batteries with or without a Power Pack, as well as power video lights. It has a 7-light battery gauge, cigarette lighter jack and volt meter jacks.....**119.95**

### High Speed Modules (HSM)

High Speed Modules speed up the recycling time of the system. There are two options Fast or X-tra Fast. The Fast Module requires a Large or X-tra Large Battery. The X-tra Fast High Speed Module will only connect to the X-tra Large Battery. This system with an X-tra Fast 400ws power pack and an X-tra Fast High Speed Module will recycle the full 400ws in about one second. The X-tra Large Battery required would guarantee 240 full power flashes. Put the HSMs next to the battery at the bottom of the system, and the system automatically recycles faster in every setting.

#### XSMF (LU054X)

Fast HSM cuts the recycle time in half for a Fast Pack. Stacks just above the battery. Requires Large or X-Tra Large Battery. Not for use on AC power. Weighs 1.1 lb .....**171.00**

#### XSMX (LU054Z)

X-Tra Fast HSM cuts the Fast Pack recycle in 1/3 or half of X-Tra Fast. Stacks just above X-Tra Large or Vehicle Battery Compartment only. (The Vehicle Battery Compartment may be used with HSMs as if it were an ultra battery. Requires Large or X-Tra Large Battery. Not for use on AC power. Weighs 1.7 lb.....**307.95**



For Any Inquiries Regarding Your Order, Call Our Customer Service:  
(800) 221-5743 • (212) 239-7765 • FAX: (800) 947-2215 • (212) 239-7549

# LUMEDYNE

## POWER PACK ACCESSORIES

### AC Power Adapters

A viable alternative to battery operation when you have AC power conveniently available, AC adapters allow you to remove the battery and run the system from a wall outlet creating an effective compact studio flash. They are equipped with Auto-Sensing circuitry designed to work seamlessly between 120v and 220v AC—no switching or adjusting needed! They are also protected from overload with a thermal “Slow Down” mode. Finally, their cooling fans are rated with a duty cycle of a professional AC strobe.

**XACF (LUXACF):** 120/240v Basic AC power supply with up to three modeling lights (low voltage) power. Has fast recycle rate regardless of which power pack is used with it. Automatically slows down if overheated. With external circuit breakers (no internal fuses). Includes molded USA cord. Fan cooled .....**264.95**

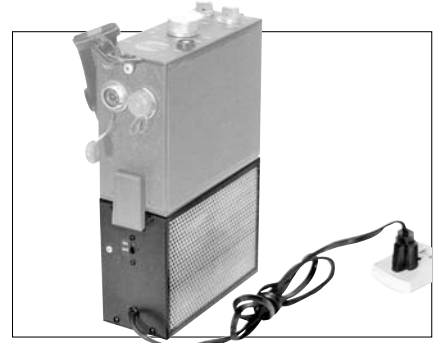

**XACX (LUXACX):** 120/240v X-Tra Fast AC power supply with only one modeling light (LV) power. Has X-Tra Fast recycle rate regardless of which power pack is used with it. Automatically slows down if overheated. With external circuit breakers (no internal fuses). Includes molded USA cord. Fan cooled .....**264.95**

FLASHES & ACCESSORIES

277



### CQ2V Car Quick Charger and Power Adapter (LU013)

The CQ2V charges 1 or 2 batteries from the cigarette lighter of your vehicle. Also powers a power pack and can operate whether the vehicle is running or not. 3.5 x 3 x 7", 2.5 lbs...**99.95**

### Battery Chargers

These chargers recharge all of the Lumedyne batteries. You can recharge batteries at any charge level. Current batteries all have an automatic shut off and full indicator built inside.



#### CT1U Trickle Charger (LU014)

Lumedyne's most basic trickle charger, the CT1U is a "wall wart" transformer that has a 5' cord ending in a molded charge plug. Trickle charges all batteries except the BXLG X-Large Battery .....**18.72**

#### CT4Z 4-Station Trickle Charger (LUTC4S)

Charges up to four batteries simultaneously at trickle charge rate. Indicators show if a battery is drawing the correct current. Only takes up one AC outlet. Not for use with BXLG X-Large Battery. 120/240v switchable. With external circuit breakers (no internal fuses) .....**114.95**

#### CQ1U Fast Charger (LU016)

About as small as the CT1U but twice as fast. Wall mount transformer with 5' cord and charge plug. Fits all sizes .....**27.95**

#### CQ2U Fast/Trickle Charger (LU017)

Can charge two batteries a time. One at trickle rate, one at quick rate or both at trickle rate. Indicator shows whether the trickle or quick rate is being used. Fits all battery sizes .....**59.95**

#### CQ2W Fast/Trickle Charger (LU017W)

Same as above, except that it is 120/240v switchable .....**CALL**

#### CQ2Z Quick Trickle Charger (LUCQ2Z)

Same as CQ2W except with external circuit breakers (no internal fuses).....**104.95**

#### CU1U Ultra

##### Automatic Charger (LU018)

The CU1U is an automatic charger that senses the voltage in the battery, tops off the battery each day. Keeps battery charged and ready to go. Charging and fully-charged indicators .....**99.95**

#### CU1Z Ultra

##### Automatic Charger (LUCU1Z)

Same as above except it works on 120v or 240v and has external circuit breakers (no internal fuses) .....**134.50**

#### Battery Adapter and Tester (LU033)

The Battery Adapter and Tester adapts the CU1U to accept up to 4 batteries. Batteries can be of different sizes and charge levels. Indicator shows healthy batteries. Charge rate is slower with each battery but is still automatic .....**83.95**

# LUMEDYNE

## SYNC CORDS & ACCESSORIES

### Super Sensitive Camera Sync Filter (LU088)

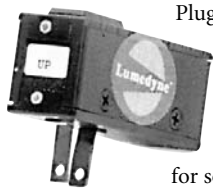

Plugs into a flash at the household (H type) sync jack and limits the voltage presented to the camera to 6.5v. This is very important for some digital cameras as well as film cameras.....**58.50**

### Sync Cords

Industry-standard sync cords for Lumedyne Flash Heads have an "H" style "household" plug connection at one end and a standard PC connection at the camera end. These heavy duty connectors assure that a proper and constant connection is maintained.

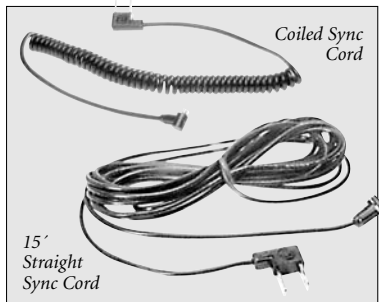

#### Coiled Sync Cord (LU030)

This heavy duty sync cable stretches from 2' to 5' .....**28.00**

#### 15' Straight Sync Cord (LUASC3)

A heavy duty sync cable with a 15' reach for setup versatility .....**37.50**

### Soft Diffuser Globe (LUADG4G)

Diffuses light over the widest possible area (over 360° like a bare bulb, but directs more light forward with gradually less reaching the foreground when used with a reflector, or may be used over a bare bulb for even diffusion. The light output will be reduced by two full f-stops .....**19.95**

#### Accommodation Kit



Extra-Wide Reflector



Op/Tech Deluxe Strap

#### Standard Reflector (LU091)

The standard reflector included with every head. Two operating positions, NORM and WIDE, allows you control over angle of dispersion .....**19.95**

#### Extra-Wide Reflector (LU091W)

Fits all flash heads for wide angle applications. Reflector is slightly shallower than the standard reflector, allowing the flash tube to disperse its output in a wider pattern ....**23.95**

#### Op/Tech Deluxe Strap (LUASDL)

A padded nylon, elasticized, contoured adjustable strap to ease carrying of all Lumedyne power packs.....**29.50**

#### Accommodation Kit (LU075)

A handy collection of small items often lost or broken line switch and jack covers, screws, rubber feet, jewels, etc .....**18.95**

### Anti-Twist Plates

#### Anti-Twist Plate (LUANTR)

For the round-style Lumedyne head when used on a flash bracket.....**8.95**

#### Anti-Twist Plate (LUANTS)

For the square-style Lumedyne head when used on a flash bracket.....**8.95**

### Extension Cords

Extension cord extends the head's cable by up to 20'. They have a very low line loss of a 1/4 f-stop at 20', and less with shorter cables.

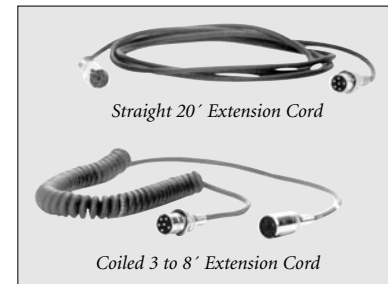

Straight 20' Extension Cord

Coiled 3 to 8' Extension Cord

#### Straight 20' Extension Cord (LU032)

.....**58.50**

#### Straight 5' Extension Cord (LU034)

.....**47.50**

#### Coiled 3-to-8' Extension Cord (LU035)

.....**57.95**

#### Straight 10' Extension Cord (LU036)

.....**49.95**

## Mounting Accessories

### Head and Umbrella Adapter to Light Stand (LU047P)

This is a versatile bracket that will fit on almost any light stand. It includes two removable, reversible studs to adapt to light stands with top studs smaller than the standard 5/8". It also includes a shoe mount, which will accept virtually any shoe-mount flash unit.....**38.50**

### Swivel Tilt and Bounce with Adjustable Stop (LU045)

Adjustable stops allow 200° of swing between user-definable points. Includes 1/4-20" hardware.....**27.95**

#### 3" Extension Post (LU041):

Raises the height of any light head with a 1/4-20" threaded receptor an additional 3" .....**17.95**

#### 6" Extension Post (LUATP6):

Raises the height any light head with a 1/4-20" threaded receptor an additional 6" .....**17.95**

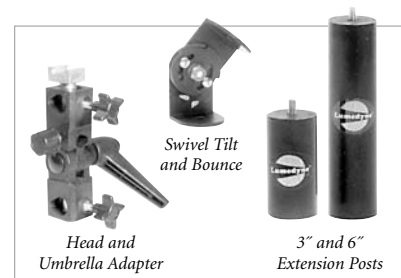

Head and Umbrella Adapter

Swivel Tilt and Bounce

3" and 6" Extension Posts

# LUMEDYNE

## CYCLERS

### High Voltage Power for High Performance Flash Recycling

Cyclers generate the high voltage necessary to recycle most shoe or handle mount flashes very quickly and produce hundreds of full power flashes per charge. Computerized flashes still use the internal AA batteries to power the internal computer, LCD screen and power reflector but the Cycler does most of the hard work (recycling the flash) so the AA's will last much longer. The cyclers feature built-in batteries, 7-LED battery gauge (except TinyCycler which has a low battery warning) and ABS plastic cases that protect the electronics from the real world bump and grinds. Two recycling rates are available, fast or X-tra fast. There are several cables available to fit many popular brands of flashes that have a high voltage connection. The Cyclers are compatible with Lumedyne and Paramount HV cables or Quantum high voltage cables for their Turbo/(Z). The Cyclers charge with the same chargers that fit the rest of the Lumedyne System (excluding the CUIU Ultra Charger that only fits modular batteries).



FLASHES & ACCESSORIES

279

#### VHTF HV TinyCycler (LUVHTF)

World's smallest and lightest high-voltage cycler with built-in battery. 1.3-sec. recycling for 350 guaranteed full power shoe mount flashes per charge. Cycling / Short / Low Battery / Full Charge protection indication. Measures 1.0 x 2.8 x 6" and weighs 1.2 lbs. If size is an important issue for you, you'll love the TinyCycler.....**264.95**

#### VHCF HV MicroCycler (LUVHCF)

Very small high voltage cycler pack with built-in battery and 7-light battery gauge. Same features and power as the VHTF. 1.3-sec. recycling for 350 guaranteed full power shoe mount flashes per charge. Slightly larger than the TinyCycler, the VHCF measures 1.3 x 2.8 x 6" and weighs 1.4 lbs.....**292.50**

#### VHUF UltraCycler (LUVHUF)

Slightly shorter but about the same size as the MiniCyclers but with more flashes. Larger built-in battery. 1.3-sec. recycling for 440 guaranteed full power shoe mount flashes per charge. Recessed HV jack and 7-light battery gauge. Measures 2.3 x 2.8 x 6", weighs 1.7 lbs .....**292.50**

#### VHUX UltraMegaCycler (LUVHUX)

Widely acclaimed in paparazzi and press photo circles, the VHUX UltraMegaCycler recycles twice as fast as any other brand of high voltage cycler pack. A larger built-in battery provides 0.7-sec recycling for 400 guaranteed full power shoe mount flashes per charge. Recessed HV jack and 7-light battery gauge. Measures 2.0 x 2.8 x 6", weighs 1.9 lbs.....**346.95**

### FLASH & HV CABLE COMPATIBILITY AND RECYCLE TIME CHART

|  | High Voltage Cycler Cable |         | Cyclers       |                    |            | Recycle Time (sec.) |       |
|--|---------------------------|---------|---------------|--------------------|------------|---------------------|-------|
|  | Lumedyne                  |         | Quantum       | Flashes Per Charge |            |                     |       |
|  | B&H #                     | Price   | Turbo Cable # | Tiny/Micro         | Mini/Super |                     | Ultra |
| Canon 430EZ, 540EZ, 480G, 550EX, 480EZ, MR-14EX  | LUVCCZ                    | \$32.95 | CZ            | 350                | 400        | 440                 | 1.3   |
| Metz 45CT1, 45CT5  | LUVCM1                    | \$32.95 | CM1           | 260                | 300        | 330                 | 2     |
| Metz 45CT3, 45CT4, 45CL1, 45CL3, 45CL4, 45CL5  | LUVCM4                    | \$32.95 | CM4           | 260                | 300        | 330                 | 2     |
| Metz 50MZ-5, 70MZ-4/5  | LUVCM5                    | \$43.95 | CM5           | 175                | 200        | 220                 | 2.5   |
| Minolta 5200i, 5400HS, 5400xi, 5600HS  | LUVCL5                    | \$32.95 | CL5           | 350                | 400        | 440                 | 1.3   |
| Nikon SB24, SB25, SB26, SB27, SB28   | LUVCNN                    | \$32.95 | CK            | 350                | 400        | 440                 | 1.3   |
| Nikon SB28 Euro, SB28DX, SB80, SB800   | LUVCNE                    | \$32.95 | CKE           | 350                | 400        | 440                 | 1.3   |
| Quantum Q Flash-T (2)  | Built-in HV Cable         |         | 130           | 150                | 165        | 4                   |       |
| Sunpak 30DX, 30SR, 36DX, 36FD, 383, 411S, 420, 421, 422D<br>433D/AF, 444D, AP52, 4000AF, 5000AF, DX8R, DX12R | LUVCS4                    | \$32.95 | CS4           | 350                | 400        | 440                 | 1.3   |
| Sunpak 411, 455, 3600, 4205G, Auto Zoom 5000   | LUVCS5                    | \$32.95 | CS5           | 350                | 400        | 440                 | 1.3   |
| Sunpak 120J Auto Pro / TTL   | LUVCS4                    | \$32.95 | CS4           | 175                | 200        | 220                 | 2.5   |
| Sunpak 511, 522, 544, 555, Zoom 3600   | LUVCS5                    | \$32.95 | CS5           | 260                | 300        | 330                 | 2     |
| Sunpak 611   | LUVCS5                    | \$32.95 | CS5           | 175                | 200        | 220                 | 2.5   |
| Sunpak 622, 622-PRO with CV1   | LUVCS5                    | \$32.95 | CS6           | 175                | 200        | 220                 | 2.5   |
| Vivitar 283, 285HV, 2500, 3700, 4600, 5200, 5600, 600's  | LUVCCV                    | \$32.95 | CV            | 350                | 400        | 440                 | 1.3   |

ORDER & INFO. (212) 502-6340 • FAX: (212) 239-7770 (800) 947-7008  
1-800-290-6750 • www.bhphotovideo.com



# QUANTUM

## BATTERIES

### Batteries for Portable Flash

Portable flash photography changed when the Quantum Battery was invented. Photographers no longer had to depend on small, unpredictable AA batteries. The battery pack clips to your belt or can be worn over the shoulder using any common camera strap. The QB1c pack is also designed to mount under your camera. An LED "fuel gauge" lets you see the remaining battery capacity—so no surprises, no missed shots. Power comes from reliable cells which exhibit no "memory" effects, plus they supply dependable power in extreme temperature climates. Simply charge your battery with the supplied charger to full capacity for hours of reliable power. Typically a Quantum Battery will supply about 5 times the power of alkaline AA batteries.



- ◆ Faster recycling — 50% faster, and consistently fast even as battery charge is depleted
- ◆ 250+ full power manual shots, and 1000+ automatic shots per charge
- ◆ Battery power comes from "no memory" sealed lead cells
- ◆ The power monitor "fuel gauge" shows remaining power in the pack—so no surprises or sudden loss of power
- ◆ Enormous cost savings. One Quantum Battery 1+ typically yields the power of \$2000 worth of AA alkaline cells
- ◆ Modules to fit hundreds of flash models.



### QB1 Compact (QB1c)

Small and light, the QB1 Compact is designed for power hungry flashes. Slip the QB1 Compact under the camera and get 12oz. of concentrated power. Enough for 150-600 auto/TTL flashes (varies with f/setting)—, or four to six times the power of typical rechargeable batteries. And when powering your flash, recycling speed is 3 times as fast as alkalines and a third faster than nicads. Outputs for both short (Bantam "X" series) and long (QB1 "M" series) cords for wearing the QB1 Compact on a belt. Includes a belt clip.

- ◆ Attaches to a tripod socket on the bottom of your camera
- ◆ Energy saver mode dims lights for longer shoots
- ◆ "No-memory" nickel metal hydride cells charge reliably in 3-4 hours
- ◆ "Fuel Gauge" LED displays power remaining and charging level, letting you know when recharging is required. Never again miss a shot waiting for your flash to recycle, or looking for another set of "AA" batteries.
- ◆ QBO Offset Multi-Bracket mounts a camera and QB1 Compact together onto a tripod.
- ◆ Outputs for both short (Bantam "X" series) and long (QB1 "M" series) cords for wearing the QB1 Compact on a belt. Includes a belt clip.

### MODULES & ACCESSORIES FOR THE QB1C

|                                    |       |                                    |       |
|------------------------------------|-------|------------------------------------|-------|
| QUXA2 Locking Module .....         | 33.95 | QUXi5 Module Type i5.....          | 36.95 |
| QUXB2 Locking Module .....         | 33.95 | QUXCX Power Cord f/Contax 645 ...  | 27.50 |
| QUXB5 Module Type B5.....          | 34.50 | QUXKZ3 Locking Module .....        | 49.95 |
| QUXK6 Module for Nikon SB-600...   | 39.95 | QUXVI Module Type VI.....          | 43.50 |
| QUXE Module Type E .....           | 34.95 | QUXZ2 Locking Module .....         | 44.95 |
| QUXE3 Module f/Metz 32Z series.... | 44.95 | QUQBO Offset Multi-Bracket.....    | 22.50 |
| QUXE4 Module for Metz 40MZ2 ....   | 44.95 | QUQBC Mounting Clamp .....         | 33.95 |
| QUXF2 Locking Module .....         | 33.95 | QUQB26 115v AC Charger (repl.).... | 34.95 |
| QUXF3 Module Type F.....           | 33.95 | QUQB35 Car Charger.....            | 89.95 |
| QUXG2 Locking Module.....          | 33.95 |                                    |       |



EQUIPMENT LEASING AVAILABLE



# QUANTUM

## QB1+/QB2/TURBO

### QB1+

Delivering 30% more power than the QB1c, the popular QB1+ pack can be used with the largest number of flash models. Dual outputs permit powering two flashes. A belt-pack battery, the QB1+ features an automatic shut off once the module connection is removed (to prevent accidental discharge) and an electronic circuit breaker. It charges in 3-4 hours and indicates when full charge is achieved.

- ◆ 50% faster recycling, and consistently fast even as battery charge is depleted.
- ◆ “Fuel Gauge” LED displays power remaining and charging level, letting you know when recharging is required. Never again miss a shot waiting for your flash to recycle, or looking for another set of “AA” batteries.
- ◆ “No-memory” lead cells charge reliably in 3-4 hours with standard charger. Charge light goes out when charging is complete.
- ◆ Provides several hundred full power flashes (250+ full power manual shots, and 1000+ automatic shots per charge) and fast, consistent recycling for most 6volt flash units.
- ◆ Electronic circuit breaker prevents damage to flash or battery. Automatically shuts itself off, and cannot be turned on without a module plugged in, preventing accidental drain of the cells.
- ◆ Twin output jacks allows two flashes to be powered together.



QUQB1P **Call**

### MODULES AND ACCESSORIES FOR THE QB1+

|  |       |  |       |
|--|-------|--|-------|
| QUMA2 Locking Module.....              | 48.95 | QUMH Module Type H.....                  | 49.95 |
| QUMB2 Locking Module.....              | 43.50 | QUMi5 Module Type i5.....                | 54.95 |
| QUMB5 Module Type B5.....              | 48.50 | QUMKZ3 Locking Module.....               | 54.95 |
| QUMC Module Type C.....                | 72.95 | QUML Module Type L.....                  | 48.50 |
| QUMCX Power Cord f/Contax 645...28.95  |       | QUMVI Module Type VI.....                | 52.95 |
| QUME Module Type E.....                | 45.95 | QUMZ2 Locking Module.....                | 49.95 |
| QUME3 Module for Metz 32Z series.49.95 |       | QUQB22 10' ext. for QB1+ modules...34.95 |       |
| QUME4 Module for Metz 40MZ2.....49.95  |       | QUQBC Mounting Clamp.....                | 33.95 |
| QUMF2 Locking Module.....              | 49.95 | QUQB26 115v AC Charger (repl.).....34.95 |       |
| QUMF3 Module Type F.....               | 48.95 | QUQB35 Car Charger.....                  | 89.95 |
| QUMG2 Locking Module.....              | 49.95 |  |       |

FLASHES & ACCESSORIES

281



QUQB2 **Call**

### Quantum Battery 2

This 9v pack powers handle mount flashes requiring other than 6v power. Dual outputs can power two flashes. Provides even more power than the QB1+ and can also power some digital cameras.

- ◆ 50% faster recycling, and consistently fast even as battery charge is depleted.
- ◆ 250+ full power manual shots, and 1000+ automatic shots per charge.
- ◆ Twin output jacks allows two flashes to be powered together
- ◆ LED displays include power monitor “fuel gauge”, on/off, short circuit, and recharging indicators. Easily monitor your units condition.

### MODULES & ACCESSORIES FOR THE QB2

|   |  |                                     |        |
|---|--|-------------------------------------|--------|
| QUMDC3 Power cable f/digital cameras...28.95  | QUMP Module for Pentax AF400T.....59.95      | QUQBC Mounting Clamp.....           | 33.95  |
| QUMDC5 Power cable for Kodak digital...28.95  | QUMS Module for Sunpak (see chart).....54.95 | QUQB27 115v AC Charger (repl.)..... | 32.50  |
| QUMM Module for Metz 45CT/45CL.....49.95      | QUMY Power Cable for                         | QUQB28 115v AC Charger (repl.)..... | 32.50  |
| QUMN Module for Nissin (see chart).....63.50  | Mamiya RZ-67 and 645 Pro Cameras.....36.95   | QUQB37 115v AC Fast Charger.....    | 107.95 |
| QUMN2 Module for Nissin (see chart).....63.50 | QUQB23 10' ext. for QB2 modules.....38.50    | QUQB36 Car Charger.....             | 74.95  |

ORDER & INFO. (212) 502-6340 • FAX: (212) 239-7770 (800) 947-7008  
**1-800-290-6750 • www.bhphotovideo.com**



# QUANTUM

## TURBO COMPACT

### Power your Camera and Flash

Today's digital cameras and flash demand more power—and different voltages. The Turbo Compact is the portable power solution. A heavy-duty portable power source for shoe and handle mount flashes, or digital cameras, the Turbo Compact is the compact version of the top-of-the-line Turbo 2x2. This pack only has one battery cell, but still has a powerfull capacity of 500 flashes and an extremely fast recycling time of 1.5 seconds (full power, shoe mount flash).

With dual outputs (one Turbo and one Bantam-type), the Turbo Compact is ideal for powering a digital camera and flash together.

It provides programmable low voltage for your digital camera and high voltage for your flash at the same time. Now your flash keeps up with your camera, and camera with flash.



### FEATURES

- ◆ The proper voltage for each camera model is automatically adjusted. To power a different camera or flash, change only the cable. Turbo Compact's energy comes from Nickel Metal Hydride (NiMH) technology, providing concentrated power, quick flash recycling, no memory, and long life.
- ◆ The Turbo Compact displays remaining capacity on its "fuel gauge" so that you won't be caught unaware.
- ◆ Power monitor "fuel gauge" tells you exactly how much power remains, and flashes a red warning light when power gets low. It also displays charging progress (which takes just 1.5 hours).
- ◆ Quantum's smallest Turbo yet, the Turbo Compact weighs just 16 ounces yet packs almost the same power of a standard Turbo. A self-contained thread screws into the socket on the bottom of a camera, and Turbo Compact itself accepts tripod threads for mounting.
- ◆ The Turbo Compact makes a perfectly balanced platform for the Qflash T2/T4 Digital after it is screwed into the base of the Qflash. Add the FreeWire to this combination and you have a small, remote-controlled flash system with the Turbo Compact, powering both the FreeWire and Qflash. This system can be placed behind a bride and groom, in a church balcony, or anywhere else that extra punch is needed to enhance a photograph.

### CABLES & ACCESSORIES FOR THE TURBO COMPACT

|   |       |
|---|-------|
| YDC30 Cable for Canon D30, D60, D100 (QUYDC30).....                             | 44.95 |
| YDC10 Cable for Nikon D2H (QUYDC10).....  | 69.95 |
| YDC100 Cable for Nikon D100 (QUYDC100).....                                     | 34.50 |
| YDC1 Cable for Nikon D1/D1x/D1H (QUYDC1).....                                   | 34.50 |
| YDC3 Cable for Kodak DCS-520/620x/720x/760 (QUYDC3) .....                       | 32.50 |
| YDC5 Cable for Kodak DCS-315/330 (QUYDC5).....                                  | 34.50 |
| YDC6 Cable for Canon 1D/1Ds (QUYDC6) .....                                      | 64.95 |
| YDC8 Cable for Kodak Pro 14n (QUYDC8) .....                                     | 33.95 |
| CCK Nikon short cable (see CK cable) (QUCCCK).....                              | 29.95 |
| CCKE Nikon short cable (see chart) (QUCCKE).....                                | 34.95 |
| CCM4 Metz short cable (see CM4 cable) (QUCCM4).....                             | 34.95 |
| CCM5P Metz short cable (see CM5+ cable) (QUCCM5P).....                          | 39.95 |
| CCS4 Sunpak short cable (see chart) (QUCCS4).....                               | 42.50 |
| CCS5 Sunpak short cable (see chart) (QUCCS5).....                               | 42.50 |
| CCV Vivitar short cable (see chart) (QUCCV) .....                               | 38.50 |
| CCZ Canon short cable (see chart) (QUCCZ).....                                  | 38.50 |
| TCRUS 100-240v Charger (repl.) (QUTCRUS) .....                                  | 44.95 |
| QT48 Dual Connector for powering two flashes (QUQT48) .....                     | 68.95 |
| QT49 10' extension cord for Turbo cables (QUQT49) .....                         | 52.50 |
| QMC Multi Clip (QUQMC) .....  | 9.95  |
| ES1 Energy Saver for Vivitar 285HV, Metz 45CL-1/3/4, 45CT-3/4 (QUES1) .....     | 5.95  |
| ES2 Energy Saver for Canon 430EZ, 540EZ, 550EX, Nikon SB-24/SB-26 (QUES2) ..... | 5.95  |

"CC" short cables are usually used with the Turbo Compact when mounted under a camera. Otherwise, it can also use the same flash cables as the standard Quantum Turbo.



For Any Inquiries Regarding Your Order, Call Our Customer Service:  
 (800) 221-5743 • (212) 239-7765 • FAX: (800) 947-2215 • (212) 239-7549



# QUANTUM

## FLASH CABLES

| Flash                           | Batteries |           |      |     |         |         |       |           |
|---------------------------------|-----------|-----------|------|-----|---------|---------|-------|-----------|
|                                 | Bantam    | QB1C      | QB1+ | QB2 | Turbo Z | Turbo C | Turbo | Turbo 2x2 |
| Canon 155A, 199A                | XA2       | XA2/MA2   | MA2  |     |         |         |       |           |
| Canon 299T                      | XB2       | XB2/MB2   | MB2  |     |         |         |       |           |
| Canon 300TL, ML-3               | XG2       | XG2/MG2   | MG2  |     |         |         |       |           |
| Canon 300EZ                     | XF2       | XF2/MF2   | MF2  |     |         |         |       |           |
| Canon 380EX, 420EX              | XF3       | XF3/MF3   | MF3  |     |         |         |       |           |
| Canon 420EZ                     | XZ2       | XZ2/MZ2   | MZ2  |     |         |         |       |           |
| Canon 430EZ                     | XZ2       | XZ2/MZ2   | MZ2  |     | CZ      | CCZ     | CZ    | CZ        |
| Canon 480G                      |           |           |      |     | CZ      | CCZ     | CZ    | CZ        |
| Canon 540EZ, 550EX              | XKZ3      | XKZ3/MKZ3 | MKZ3 |     | CZ      | CCZ     | CZ    | CZ        |
| Contax TLA-30                   | XA2       |           |      |     |         |         |       |           |
| Contax TLA-280                  | XA2       | XA2/MA2   | MA2  |     |         |         |       |           |
| Contax TLA-360                  | XKZ3      | XKZ3/MKZ3 | MKZ3 |     | CKE     |         | CKE   | CKE       |
| Cullman MC-25/MC30/CX35/CX40    | XG2       | XG2/MG2   | MG2  |     |         |         |       |           |
| Fujica 300X                     | XF2       |           |      |     |         |         |       |           |
| Hasselblad 4504                 |           |           |      | MM  | CM4     | CCM4    | CM4   | CM4       |
| Hasselblad D-Flash 40           |           |           |      |     | CS4     | CCS4    | CS4   | CS4       |
| Metz 25CT-3, 28CT-3, 38CT-3     | XA2       | XA2/MA2   | MA2  |     |         |         |       |           |
| Metz 32CT- Series (except CT-7) | XE        | XE/ME     | ME   |     |         |         |       |           |
| Metz 32Z- Series                | XE3       | XE3/ME3   | ME3  |     |         |         |       |           |
| Metz 36CT- Series               | XE        | XE/ME     | ME   |     |         |         |       |           |
| Metz 40MZ1i, 40MZ2, 40MZ3       | XE4       | XE4/ME4   | ME4  |     |         |         |       |           |
| Metz 45CT-1/CT-5                |           |           |      | MM  | CM1     |         | CM1   | CM1       |
| Metz 45CL-1/3/4, 45CT-3/4       |           |           |      | MM  | CM4     | CCM4    | CM4   | CM4       |
| Metz 54MZ-3/54MZ-4              | XKZ3      | XKZ3/MKZ3 | MKZ3 |     | CM5+    | CCM5+   | CM5+  | CM5+      |
| Metz 50MZ-5, 70MZ-4/70MZ-5      |           |           |      |     | CM5+    | CCM5+   | CM5+  | CM5+      |
| Minolta 280PX                   | XA2       |           |      |     |         |         |       |           |
| Minolta 320PX, 80PX             | XA2       | XA2/MA2   | MA2  |     |         |         |       |           |
| Minolta 360PX                   | XA2       | XA2/MA2   | MA2  |     | CL3     |         | CL3   | CL3       |
| Minolta 2800AF, 1200AF Macro    | XE        | XE/ME     | ME   |     |         |         |       |           |
| Minolta 4000AF                  | XB2       | XB2/MB2   | MB2  |     | CL4     |         | CL4   | CL4       |
| Minolta 3200i                   | Xi        | Xi/Mi     | Mi   |     |         |         |       |           |
| Minolta 3500Xi                  | Xi5       | Xi5/Mi5   | Mi5  |     |         |         |       |           |
| Minolta 5400HS, 5400Xi, 5200i   | Xi5       | Xi5/Mi5   | Mi5  |     | CL5     |         | CL5   | CL5       |
| Minolta 3600HS (D)              | XKZ3      | XKZ3/MKZ3 | MKZ3 |     |         |         |       |           |
| Minolta 5600HS (D)              | XKZ3      | XKZ3/MKZ3 | MKZ3 |     | CL5     |         | CL5   | CL5       |
| Nikon SB-23, SB-12, SB-16       | XG2       | XG2/MG2   | MG2  |     |         |         |       |           |
| Nikon SB-15, SB-17              | XF2       | XF2/MF2   | MF2  |     |         |         |       |           |
| Nikon SB-20, SB-22              | XE        | XE/ME     | ME   |     |         |         |       |           |
| Nikon SB-24, SB-25              | XKZ3      | ZKZ3/MKZ3 | MKZ3 |     | CK      | CCK     | CK    | CK        |
| Nikon SB-21                     | XF2       |           |      |     |         |         |       |           |

# QUANTUM

## FLASH CABLES

| Flash                                    | Batteries |           |      |     |         |         |       |           |
|--|-----------|-----------|------|-----|---------|---------|-------|-----------|
|  | Bantam    | QB1C      | QB1+ | QB2 | Turbo Z | Turbo C | Turbo | Turbo 2x2 |
| Nikon SB-26, SB-27, SB-28                | XKZ3      | XKZ3/MKZ3 | MKZ3 |     | CK      | CCK     | CK    | CK        |
| Nikon SB-28-EURO, 28D, 28DX, 80DX        | XKZ3      | XKZ3/MKZ3 | MKZ3 |     | CKE     | CCKE    | CKE   | CKE       |
| Nikon SB-29                              | XKZ3      | XKZ3/MKZ3 | MKZ3 |     |         |         |       |           |
| Nikon SB-600                             | XK6       |           |      |     |         |         |       |           |
| Nikon SB-800                             | XKZ3      | XKZ3/MKZ3 | MKZ3 |     | CKE     | CCKE    | CKE   | CKE       |
| Nissin 340T, 360WX, 360TW                | XG2       | XG2/MG2   | MG2  |     |         |         |       |           |
| Nissin 4000GW, 4800GT, 5000GT            |           |           |      | MN  |         |         |       |           |
| Nissin 4200, 4500GTE, 6000AF/GT, 5000GT  |           |           |      | MN2 |         |         |       |           |
| Olympus FL-40                            | XA2       | XA2/MA2   | MA2  |     |         |         |       |           |
| Olympus FL-50                            | XKZ3      | XKZ3/MKZ3 | MKZ3 |     |         |         |       |           |
| Olympus T32                              | XE        | XE/ME     | ME   |     | CO3     |         | CO3   | CO3       |
| Olympus T45                              |           |           |      |     | CO3     |         | CO3   | CO3       |
| Pentax AF200T, AF280T                    | XA2       | XA2/MA2   | MA2  |     |         |         |       |           |
| Pentax AF400T                            |           |           |      | MP  |         |         |       |           |
| Pentax AF500FTZ                          |           |           |      |     | CN3     |         | CN3   | CN3       |
| Sigma EF430                              | XG2       | XG2/MG2   | MG2  |     |         |         |       |           |
| Sigma EF500ST, EF500 Super               | XVI       | XVI/MVI   | MVI  |     |         |         |       |           |
| Sunpak 411S, 383, 422D, 433D/Af, 444D    | XG2       | XG2/MG2   | MG2  |     | CS4     | CCS4    | CS4   | CS4       |
| Sunpak 30SR, 30DX, 36FD, 36DX            | XG2       | XG2/MG2   | MG2  |     | CS4     | CCS4    | CS4   | CS4       |
| Sunpak 331, 333, 333D, 344D, 355AF       | XG2       | XG2/MG2   | MG2  |     |         |         |       |           |
| Sunpak 26DX/FD/SR, 260, 266D             | XG2       | XG2/MG2   | MG2  |     |         |         |       |           |
| Sunpak Auto DX8R                         | XA2       | XA2/MA2   | MA2  |     | CS4     | CCS4    | CS4   | CS4       |
| Sunpak Auto DX12R                        | XG2       | XG2/MG2   | MG2  |     | CS4     | CCS4    | CS4   | CS4       |
| Sunpak 411/511                           |           |           |      |     | CS5     | CCS5    | CS5   | CS5       |
| Sunpak 522, 544, 555, 455, Autozoom 3600 |           |           |      | MS  | CS5     | CCS5    | CS5   | CS5       |
| Sunpak AP52, 4000AF                      |           |           |      |     | CS4     | CCS4    | CS4   | CS4       |
| Sunpak PZ5000AF                          | XKZ3      | XKZ3/MKZ3 | MKZ3 |     | CS4     | CCS4    | CS4   | CS4       |
| Sunpak 611, Autozoom 5000                |           | MC        |      |     | CS5     | CCS5    | CS5   | CS5       |
| Sunpak 622, 622 PRO                      |           |           | MH   |     | CS6     |         | CS6   | CS6       |
| Sunpak 120J Auto Pro/TTL                 |           |           | MA2  |     | CS4     | CCS4    | CS4   | CS4       |
| Sunpak MZ440AF-CA, MX                    | XG2       | XG2/MG2   | MG2  |     |         |         |       |           |
| Vivitar 283, 285HV, 3700, 4600           | XA2       | XA2/MA2   | MA2  |     | CV      | CCV     | CV    | CV        |
| Vivitar 285                              | XA2       | XA2/MA2   | MA2  |     |         |         |       |           |
| Vivitar 4900VT                           |           |           |      | MN2 |         |         |       |           |
| Vivitar 5200, 5600                       | XG2       | XG2/MG2   | MG2  |     | CV      | CCV     | CV    | CV        |
| Vivitar 3900                             |           |           |      |     | CN3     |         | CN3   | CN3       |
| Vivitar 628AFM, 636AF                    | XF2       | XF2/MF2   | MF2  |     |         |         |       |           |
| Vivitar 5250, 728Zoom, 836AF             | XG2       | XG2/MG2   | MG2  |     |         |         |       |           |
| Vivitar 730 AFC                          | XB5       | XB5/MB5   | MB5  |     |         |         |       |           |
| Vivitar 736 AFM, 840 AFC                 | XVI       | XVI/MVI   | MVI  |     |         |         |       |           |
| Yashica CS250AF                          | XG2       | XG2/G2    | MG2  |     |         |         |       |           |

FLASHES & ACCESSORIES

285

ORDER & INFO. (212) 502-6340 • FAX: (212) 239-7770 (800) 947-7008  
**1-800-290-6750 • www.bhphotovideo.com**



# QUANTUM

## QFLASH T4D & X4D DIGITAL

### Studio Quality, High Power Automatic/TTL Portable Flashes

The Qflash T4D is powered by a Quantum Turbo or Turbo 2x2 to produce powerful Guide Number 160 auto-flash power, while the Qflash X4D is powered by Quantum's Qpaq-X, as well as Lumedyne or Norman power packs. At 400 watt-seconds Qflash X4D produces GN 220 flash power. Both Qflashes have a stroboscopic modeling light, and both use parabolic reflectors for softer, cleaner light. The reflectors are removable for bare-bulb lighting. The flash head bounces and swivels and can be locked into place with the new locking function. Flash control is either automatic, TTL (with optional adapters), manual, or stroboscopic, to be precisely what you need. Qflashes can be ganged together to produce flexible lighting setups with thousands of watt-seconds of auto or manual flash power. Qflashes mounts on a camera bracket, tripod, or lightstand and weigh no more than a conventional flash.



### FEATURES

- ◆ Automatic exposure control covers a nine stop range, adjustable every 1/3 stop, for a total of 25 automatic settings.
- ◆ Manual power can be adjusted from full to 1/64 power in 1/3 stop increments. Flash power can be precisely what you need.
- ◆ Store up to eight of your favorite settings (for example, auto @ f/8, f/16 manual @ 1/4 power) and switch between them at a push of a button.
- ◆ To avoid harshness that can be produced by rectangular reflectors, the Qflashes use a parabolic reflector. Coverage includes 55° (normal position), 70° (wide angle) and 90° (with supplied diffuser). Or remove the reflector for 360° bare-bulb coverage.
- ◆ With optional adapters for TTL cameras, you can control the Qflash exposure through-the-lens. TTL operation indicates visually as well as audibly the proper and under/over exposure.
- ◆ QTTL adapters link the most popular digital and film cameras to Qflash Digital. Allows you to select rear curtain sync and/or auto focus assist light.
- ◆ Stroboscopic mode can be adjusted for flash power, and number and frequency of bursts. Select a strobe rate of 1 to 50 flashes per second. You can also select the power level and the total number of flashes from 1 to 20.
- ◆ LCD shows minimum and maximum flash distance range for each auto setting, mode, F#, GN #, flash ready, OK and under/over exposure checks. Readouts can be converted between feet or meters. Also provides audible indication of correct exposure.
- ◆ Automatic Fill Mode allows setting fill flash ratios (-3 to +2 stops in 1/3 increments) when used with one of the QTTL adapters. Fill-flash ratios can be controlled even for cameras that don't have fill-flash capabilities
- ◆ One Qflash can control the exposure of an unlimited number of Qflash "slaves" connected to it for increased lighting power, or lighting difficult subjects with multiple flash heads. Slaves are controlled via a TTL adapter or their own auto setting. Each can be set independently—to its own automatic, manual or stroboscopic exposure for precise lighting ratios and light control.
- ◆ If you are using Qflash on-camera and you want to disable it for a few shots you can use the "quick turn off" feature. Press the MODE button twice and "OFF" appears in the display. Press any button (except the test flash) to return to normal operation.
- ◆ Optional remote sensor lets you put Qflash anywhere you want (up to 100' away with cable extensions) and read the light at the camera position.

#### Automatic Sensor Limit

This option on the Qflash T4D / X4D limits the distance the Qflash sensor "sees" when in Auto mode. Without Auto Sensor Limit, if the subject has no background (in a open field outside), or the background is far away (a large catering hall), the flash sensor tries to balance the subject and background light. The subject is bright, and the background is dark, and the result is an over exposed subject. By limiting sensor distance, the sensor will no longer try to balance the light from a far background and will focus only on the subjects that are within the sensor limit. The result, great automatic exposures in all situations.

# QUANTUM

## QFLASH T4D & X4D DIGITAL



### Qflash T4D (QUQT4D)

Includes 6' coiled power cord, reflector, diffuser, removable flashtube, earphone and 1/4-20 mounting thumbscrew. Requires Turbo, Turbo 2x2 for power .....CALL

### Qflash X4D (QUQFX4D)

Includes reflector, modeling lamp, removable flashtube, diffuser, earphone and 1/4-20 mounting thumbscrew. Powered by QPAQ-X, Lumedyne or Norman 200 and 400 watt-second power packs. Norman and Lumedyne require a QF40, 41, or 42 power cable .....CALL

### Qflash T4D Accessories

**Flashtube (QUQF30):** Replacement .....43.50

**Flashtube (QUQF30UV)**  
Optional UV-coated flashtube .....52.95

**200w/S Remote Flash Head (QUQF36T)**  
With 8' extension cord.....122.50

**Dual Connector (QUQT48)**  
For powering two Qflashes with a Turbo Battery .....68.95

**10' Extension Cord (QUQT49)**  
For Turbo cables.....52.50

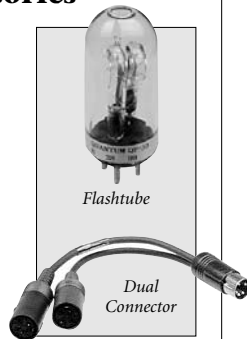

### Qflash X4D Accessories

**Flashtube (QUQF32):** Replacement .....57.95

**Flashtube (QUQF32UV)**  
Optional UV-Coated Flashtube.....67.95

**35w Model Lamp for Qflash (QUQF33)** ...17.95

**400w/S Remote Flash Head (QUQF36X)**  
With 8' extension cord.....129.95

**Adapter for QFX Flash Head (QUQF40)**  
Adapts QFX to Norman 200B/C .....59.50

**Adapter for QFX Flash Head (QUQF41)**  
Adapts QFX to Norman 400B .....59.50

**Adapter for QFX Flash Head (QUQF42)**  
Adapts QFX to Lumedyne packs .....59.50

**Straight 16.5' Extension Cord (QUQF43)**...59.50



### FULLY DEDICATED QTTL ADAPTERS FOR T4D/X4D QFLASH

**D12 Adapter (QUQFD12)**  
For Nikon N90s, F100, F5, D1 series, D100 and Fuji S2 ...109.95

**D24 Adapter (QUQFD24)**  
For Contax 645 .....109.95

**D13N Adapter (QUQFD13N)**  
For Canon EOS-1v, EOS-3, 10D, 20D, 1D II, 1Ds, Rebel .....109.95

**D25 Adapter (QUQFD25)**  
For Mamiya 645AF/AFD..109.95

### Accessories for all Qflashes

**Spare Reflector (QUQF60B)** .....28.95

**Snoot (QUQF61B)**  
For pinpoint lighting. Provides a hair light or accent for subjects .....23.95

**Bare Bulb Enhancer (QUQF62BS)**  
Polished satin silver reflector .....29.95

**Bare Bulb Enhancer (QUQF62BG)**  
Polished satin gold reflector .....28.95

**Telephoto Reflector (QUQF63B)**  
With QF63S Flashtube Spacer .....69.95

**Flashtube Spacer (QUQF63S)**  
For use with the Telephoto Reflector ....28.50

**Diffusing UV Filter Kit (QUQF64)**  
Replacement diffuser panel and cover ...17.95

**Clear UV Filter Kit (QUQF65)** .....17.95

**Color Gel Pack (QUQF66)** .....24.95

**Wide Angle Diffuser (QUQF67A)**  
Emits a very soft light with minimal shadows and 2 stop lower Guide Number .....32.95

**12 x 12 Softbox (QUQF68)**  
The softbox offers a bigger, softer light source for close-up portraiture. With the softbox connected, the Qflash can be mounted to a camera bracket or fastened to an umbrella bracket for placement on a light stand. The Qflash/softbox combination is suited for either TTL or manual operation. The Softbox folds up very neatly into its carrying bag for your convenience. ....59.95

**Quick Release "L" Bracket (QUQF70E)** ....87.95

**Camera/Flash Flip Bracket (QUQF70US)**  
A lightweight aluminum flash bracket..107.95

**QF72 Qflash Multi Bracket (QUQF72)**  
Includes umbrella swivel and "L" bar .....44.95

**"L" Bar For QF72 (QUQF73)** .....22.50



FLASHES & ACCESSORIES

287

# QUANTUM

## QFLASH ACCESSORIES

### Control Cables for Qflashes

- QF50** (QUQF50): 20' cable for slaving two Qflashes together.....**34.95**
- QF51** (QUQF51): Male-to-female, 20' extension cable. To extend QF50, 52, 53 cables, TTL adapters, or QF21. Maximum length is 100' using 5 QF51 cables.....**34.95**
- QF52** (QUQF52): "Y" connector module needed for third Qflash connected, and each one thereafter. Required for a TTL adapter or remote sensor when used with two or more Qflashes.....**43.95**
- QF53** (QUQF53): Hot shoe sync adapter..**43.95**
- 536** (QUSCCP18RS4T): PC to household male 18" coiled sync cord .....**28.95**
- 537** (QUSCCP5RS4T): PC to household male 5' coiled sync cord .....**26.50**



### Remote Flash Heads for Qflash

Now Qflash users can mount a lightweight flash head in light boxes, high up on light stands, or in other remote locations. At the same time the Qflash control panel can mount conveniently at eye level for easy access.

- ◆ Remote Qflash Heads with 8' cables plug into the flash tube socket of a Qflash. A 1/4-20 threaded socket allows for convenient mounting in a light box, umbrella bracket, or lightstand. Remote Flash Heads can be mounted to other Quantum mounting accessories such as QF72 Multi Bracket and QF73 "L" Bar.
- ◆ With the Remote Qflash Heads, photographers can shoot in all Qflash modes – automatic, TTL, manual, and strobo. All Qflash reflectors and attachments are compatible giving a new dimension to light control with Qflash's. Remote Qflash Heads are available as QF36T to fit Qflash T2/T4D, or QF36X to fit the Qflash X2/X2D.

### TTL Adapters and Remote Sensor for all Qflashes

- QF11** For Minolta X700, X500, X570, CLE, Maxxum- 5000, 7000, 9000 (QUQF11) .....**64.95**
- QF12** For Nikon FA, FG, FE2, F100, N2000, N2020, F301, F4, F4S, F401, F401S, N4004, F5, F501, F601, F601M, N60, N6000, N6006, N70, F801, N8008, N90, N90S, Fuji FinePix S1 Pro (QUQF12) .....**73.50**
- QFD13N** For Canon EOS-3, EOS-1N, EOS-1v (QUQFD13N) .....**109.95**
- QF14** For Minolta XiDynax & Maxxum - 3000i, 3700i, 5000i, 700i, 7000i, 8000i, 8700i; 3Xi, 5Xi, 7, 7Xi, 9, 9Xi, SPXi, Dimage RD-3000 Digital Camera (QUQF14).....**73.50**
- QF15** For Contax RTS II, RTS III, MD137, MA137, 139, 159MM, 167MT, G1, G2 (QUQF15) .....**65.95**
- QF16** For Leica R5, RE, R6, R6-2, R7 (QUQF16) .....**65.95**
- QF17** For Pentax SFX, SFXn, SF1, SF1n, SF7, SF10, Z1, Z10, PZ1, PZ10, LX (with finder shoe) Super A, 645/645N (QUQF17) .....**65.95**
- QF18** For Rollei SL2000f, 3001, 3003, SL66e, SL66x, SL66se, SL6006 , 6002, 6003, 6008/i, 2.8GX (QUQF18) .....**137.50**
- QF19** For Hasselblad 500ELX, 503CW/CX/CXI, 553ELX, 555ELD, 201F, 202FA, 203FE, 205TCC/FCC (QUQF19).....**157.50**
- QF20** For Bronica ETRsi, SQAi (QUQF20) .....**175.95**
- QF21** Remote Sensor (shoe mount with live sync contacts) (QUQF21) .....**124.50**
- QF22** For Mamiya 645 Pro TL (QUQF22).....**175.95**
- QF23** For Leica R8 (QUQF23).....**174.50**
- QF24** For Contax 645 (QUQF24).....**137.50**
- QF25** For Mamiya 645AF, 645AFD (QUQF25) .....**175.95**



For Any Inquiries Regarding Your Order, Call Our Customer Service:  
 (800) 221-5743 • (212) 239-7765 • FAX: (800) 947-2215 • (212) 239-7549



# QUANTUM

## QPAQ-X

### Modular Power Pack for Qflash X2/X2D/X4D

Leave your AC studio flash at home...the Qpaq-X flash system works for both location and candid photography. A high energy, modular power pack with 200•400•600•800 watt-seconds of portable flash power, you can connect one or two Qflash-X2 400 watt-second heads and shoot manual, automatic, TTL or Strobe mode!

Qpaq-X has a removable battery that is user replaceable. Select from either small or large battery modules to fit the needs of your assignment. Then add or remove "PXC" modules to create a compact 200 watt-second pack or a two head, studio system up to 800 watt-seconds.



### FEATURES

- ◆ Aim two Qflash X2's into umbrellas or light boxes connected to an 800ws Qpaq-X. Use this set-up in your studio with conventional or digital cameras. Pack this same outfit and take it on location for indoor or outdoor use. After portraiture photography is finished, break down the Qpaq-X to either a 200 or 400 watt-second pack and use it for your grip and grin shots.
- ◆ The Qpaq-X/Qflash X is the only flash system that gives you 800 watt-seconds of studio quality lighting for manual, auto-matic, strobo and TTL exposure control.
- ◆ Quantum's "no memory" battery system lets you charge the Qpaq-X from any capacity level. A new charging design displays the level of charge going into the battery from 25%, 50%, 75% to 100% full capacity. Remove the battery from the charger at any time for emergency use.
- ◆ Read the battery's remaining capacity with "fuel gauge" indicators
- ◆ Ratio power to each flash head
- ◆ Work with AC mains or battery power
- ◆ Switch from "ultra" recycling (1.8-seconds) to "normal" (3.2-seconds) mode for maximum operating time
- ◆ Replaceable battery for continuous power on location
- ◆ Mount Qpaq-X to a lightstand, monopod or tripod with the PPM Pole Mount Kit
- ◆ AC Module PAC charges on-board battery while shooting using PR1, PR2 or PR3

Think building blocks when you put together a Qpaq. At the top there is always a "PX" Command Module. Build your system up to 800 watt-seconds with 200 watt-second "PXC" modules. Then snap on a high capacity PB1 or compact PB2 battery.

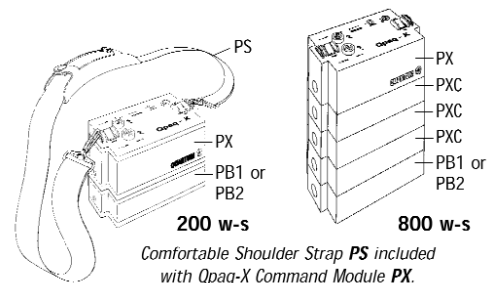

Comfortable Shoulder Strap PS included with Qpaq-X Command Module PX.

### QPAQ-X AND QFLASH PERFORMANCE CHART

| Qpaq Speed | 200 Watt-Seconds |          |     | 400 Watt-Seconds |          |     |
|------------|------------------|----------|-----|------------------|----------|-----|
|            | Recycling        | Capacity |     | Recycling        | Capacity |     |
|            |                  | PB2      | PB1 |                  | PB2      | PB1 |
| ULTRA      | 1.8 sec          | 120      | 275 | 3.6 sec          | 60       | 140 |
| NORMAL     | 3.2 sec          | 160      | 350 | 6.4 sec          | 80       | 180 |

Recycling & Capacity shown for full power manual. Automatic flash can be many more shots and faster recycling, depending upon shooting conditions. All data is approximate for illustration only.

### MODULES AND ACCESSORIES FOR THE QPAQ-X

**Qpaq-X (QUPX):** Power pack for Qflash-X flash. Two outputs, capacity gauge and normal or ultra fast recycling button. Requires PB1 or PB2 and charger. Includes a shoulder strap .....**Call**  
**PXC 200ws add-on module (QUPXC)** .....**144.95**  
**PB1 High-performance battery (QUPB1)**...**216.50**  
**PB2 Compact battery (QUPB2)**.....**183.50**  
**PAC AC Module w/o charger (QUPAC)** .....**179.95**  
**PPM Pole mount for lightstand (QUPPM)**...**41.95**

**PDC Dual Charge Adapter (QUPDC):** (charges one or two batteries using PR1, PR2, PR3 or PRV) .....**169.95**  
**PCL Lumedyne adapter cable**.....**59.95**  
**PR1US 115v Charger (QUPR1US)**...**33.50**  
**PR2 Universal Charger (QUPR2)** ....**94.95**  
**PR3US Fast Charger (QUPR3)** .....**42.95**  
**PRV Car Charger (QUPRV)**.....**74.95**  
**PR4 AC Module (QUPR4)** .....**307.95**

FLASHES & ACCESSORIES

289

ORDER & INFO. (212) 502-6340 • FAX: (212) 239-7770 (800) 947-7008  
**1-800-290-6750 • www.bhphotovideo.com**



# QUANTUM

## RADIO SLAVE 4i

### Radio Slave System for Remote Flashes and Motor Drives

Quantum's Radio Slave 4i system allows you to synchronize any number of remote flashes without long sync cords, or use it to trip motor drives at great distances. It uses digitally coded radio signals that work indoors, outdoors, around corners and through walls. This superior interference-free operation permits many Radio Slaves to operate in the same area. And, unlike other slaves, it cannot be overpowered by the light of a flash.

The Radio Slave 4i system syncs up to 1/500 sec. with focal plane shutters, 1/1000 with leaf shutters. Faster than other wireless sync, Radio Slave 4i is virtually indistinguishable from "wired" sync. And, there is no waiting between triggers as with infra-

red slaves. When mounted on a camera with a hot shoe, the Sender (transmitter) unit connects directly without a cord. The Remote (receiver) connects directly to the flash using the flash sync cord. Adapters are not needed. Confirmation of radio signal is assured by Radio Slave's status light. It also warns hours in advance of low battery. Each Radio Slave has 4 channels of operation and is available in 4 discrete frequencies, to avoid interference from other shooters.



### FEATURES

- ◆ Trigger any number of remote flashes without a sync cord. Or you can trip a motor drive camera, or a remote power pack at great distances.
- ◆ Instant re-triggering for multiple flash bursts. Faster than any motor drive sequence.
- ◆ Range is up 350' (110m), or 200' (60m) with the antenna down

- ◆ Hot shoe mount for the Sender allows attachment to a camera shoe, and sync cord is not required.



- ◆ Or use the supplied sync cord to connect to camera sync. Can also be mounted to brackets, dead shoes, etc. with velcro (supplied).
- ◆ The 4i Remote operates up to 400 hours on 4 AA batteries and 800 hours with 4 AA lithium batteries. Also runs on AC power with optional AC adapters.

- ◆ Syncs up to 1/500 sec. with focal plane shutters, 1/1000 with leaf shutters. Extremely fast synchronization means Radio Slave 4i is virtually indistinguishable from "wired sync".
- ◆ LED status lights on the Sender and Remote confirm proper operation and/or low batteries.

- ◆ User selected coded channels permit many Radio Slaves to operate in the same area with superior interference free reception.
- ◆ Radio Slave 4i is compatible with the older Radio Slave 2 & 4. Be sure to match the labeled frequency (either A, B, C, D) with your previous units.

### Radio Slave 4i Components & Sets

#### Radio Slave 4i Remote QURS4IR( )

Includes shoe/tripod mount adapter, pole mount adapter (available in A, B, C, D frequency, please specify) .....Call

#### Radio Slave 4i Sender QURS4IS( )Q

Includes sync cord, belt clip, dead shoe with screw for bracket mounting, velcro, and mounting plate (available in A, B, C, D frequency, please specify) .....Call

#### Radio Slave 4i Set QURS4IS( )

Includes 505Si Sender and 505Ri Remote, belt clip, sync cord, mounting kit (specify frequency only to match existing set) .....Call

# QUANTUM

## FREEWIRE

### Digital Transceiver

Create a two-way link between your camera, flash and you with Quantum's FreeWire. A digital transceiver, each FreeWire unit can be set to transmit or receive. 4 FreeWire's can serve as two send/receive systems, operating on two different channels. Or all FreeWire's can be set on the same channel so that they can operate as one system — a transmitter and three receivers.



FLASHES & ACCESSORIES

291

### FEATURES

- ◆ Antenna folds out of the way for compact storage
- ◆ Confirmation and Status light tell you your radio link is working
- ◆ Mounts to light poles, stands, and brackets (hardware included)
- ◆ Two motor drive modes:
  - Use FreeWire's two step motor drive cords to keep your camera meter and focus function continuously on (as in pressing the shutter button half way). Your camera will be ready for instant shutter release.
  - Or select motor drive "delay" to command a camera to "wake up", focus and meter, then release the shutter.
- ◆ For sports or fast fashion shoots, you can sequence up to 4 remote power packs, giving each pack time to recycle. FreeWire will activate the power packs in sequence, advancing to the next with each shot.
- ◆ Exclusive Relay Mode: Trigger your camera wirelessly. The FreeWire connected to the camera relays the shutter sync to a remote flash. Only 3 FreeWire units are required, instead of 4 as with other systems. The remote flash can synchronize in manual, auto, or TTL mode! You can choose any combination of multiple remote flashes from the hand held FreeWire transmitter.
- ◆ Five Power Options:
  - FreeWire batteries last about 120 hours, or 7200 shots @ one shot/minute.
  - No batteries needed when an FW31 cord connects FreeWire to a Qflash.
  - "Sleep" option to provide up to 500 hours of standby time from its own batteries.
  - Optional FW29 AC adapter.
  - Cords MDC2 and XDC2 used with Quantum 1, 1+, 1c, or Bantam Batteries.

### 8 Independent Channels

FreeWire has eight unique channel codes. FreeWire units set to one channel cannot activate FreeWires set to different channels. You control the channel code to make FreeWire units work together or independently, as required. There are 32 individual Channel/Zone settings at your disposal, and 256 possible lighting combinations!

### 4 Zone Control Plus Local

FreeWire controls one Local Zone and four wireless Zones for flash or motor drive. You can activate any one Zone, or any combination of Zones 1, 2, 3, 4 and Local. Switch your lighting instantly, remotely. Select and trigger flashes, cameras, or combinations of them, from your remote position.

### Wireless TTL

A FreeWire connected to one of Quantum's TTL adapters transmits TTL information to any number of remote FreeWire /Qflash combinations. A "local" Qflash will synchronize also.

### Wireless Auto

Without a TTL adapter, a local Qflash & FreeWire can control exposures of any number of remote Qflash/FreeWire combinations.

### Convenient Connections

You can hot shoe sync with FreeWire's optional Uni-Mod module, use twin blade sync cords, or numerous other cords. FreeWires use Quantum's motor drive cords for remote wireless shutter.

### FREEWIRE TRANSCIVER & MODULE

**FreeWire Digital Transceiver (QUFW10):**  
Becomes Transmitter or Receiver. Includes sync cord, mounting kit, batteries and instruction manual .....Call

**Uni-Mod Universal Connector Module (QUFW11):**  
With hot shoe and female household connector. Use with standard household to PC sync cord.....49.95



ORDER & INFO. (212) 502-6340 • FAX: (212) 239-7770 (800) 947-7008  
1-800-290-6750 • www.bhphotovideo.com



# QUANTUM

## FREEWIRE & RADIO SLAVE ACCESSORIES

### *FreeWire and Radio Slave Sync Cords*

| Model | Description  | Compatibility |     |      |      | Price |
|-------|--|---------------|-----|------|------|-------|
|       |  | 405           | 505 | 505i | FW10 |       |
| 434   | 1.5' replacement sync-in cord (QUSCIRS2T)  | Yes           | —   | —    | Yes  | 27.95 |
| 435   | 4' coiled sync-in cord (QUSCARS2T)   | Yes           | —   | —    | Yes  | 27.95 |
| 470   | Special Sync-in Cord for Hasselblad "C" lens (QUSCHCRS2T)  | Yes           | —   | —    | Yes  | 32.95 |
| 534   | 1.5' Coiled Sync Cord - PC male household male (QUSC18RS4T)  | —             | Yes | Yes  | Yes  | 28.95 |
| 535   | Coiled Sync Cord, 5' for 505S/Si - PC male to household male (QUSC5RS4T)   | —             | Yes | Yes  | Yes  | 28.50 |
| 536   | 1.5' coiled sync cord - PC male to household male (twin prong with center pin) - for 505S/Si (QUSCCP18RS4T)            | —             | Yes | Yes  | Yes  | 28.95 |
| 537   | 5' coiled sync cord - PC male to household male (twin prong with center pin) for 505S/Si (QUSCCP5RS4T)                 | —             | Yes | Yes  | Yes  | 26.50 |
| 539   | 12" straight replacement sync cord - PC male to household male (twin prong with center pin) - for 505S/Si (QUSC12RS4T) | —             | Yes | Yes  | Yes  | 28.95 |
| 540   | Sync-Out- Qflash sync household to household (QUSCHHHHQF)  | —             | Yes | Yes  | Yes  | 23.95 |
| 541   | Sync-Out - Qflash sync household to mini phono (QUSCHHHHQF)  | Yes           | —   | —    | Yes  | 28.95 |
| 570   | Special Sync Cord for Hasselblad "C" lens (QUSCHCRS4T)   | —             | Yes | Yes  | Yes  | 32.95 |
| QF53  | Hot Shoe Sync Adapter for 505S via hot shoe of camera (QUQF53)   | —             | Yes | Yes  | Yes  | 43.95 |
| FW20  | Sync-in Cord 18", PC to FreeWire accessory connector (QUFW20)  | —             | —   | —    | Yes  | 32.95 |
| FW21  | Hot Shoe Sync 18", to FreeWire accessory connector (QUFW21)  | —             | —   | —    | Yes  | 39.95 |
| FW22  | Hot Shoe Sync 18", hot shoe to FreeWire sync-in (QUFW22)   | —             | —   | —    | Yes  | 47.95 |
| FW31  | Ext Cable 18", FreeWire accessory connector to Qflash or Uni-mod accy connector (QUFW31)                               | —             | —   | —    | Yes  | 32.95 |

### *FreeWire Wireless TTL Adapters and Miscellaneous Cables*

|  |       |
|--|-------|
| FW52 (QUFW52): Wireless TTL adapter for Nikon .....  | 78.95 |
| FW53N (QUFW53N): Wireless TTL adapter for Canon .....  | 78.95 |
| FW57 (QUFW57): Wireless TTL adapter for Pentax .....   | 82.95 |
| FW59 (QUFW59): Wireless TTL adapter for Hasselblad.....  | 82.95 |
| FW60 (QUFW60): Wireless TTL adapter for Bronica.....   | 86.50 |
| FW64 (QUFW64): Wireless TTL adapter for Contax 645 .....   | 86.50 |
| FW65 (QUFW65): Wireless TTL adapter for Mamiya 645AF .....   | 86.50 |
| XDC2 (QUXDC2): External power connection from Bantam or QB1c to FreeWire .....                               | 27.50 |
| MDC2 (QUMDC2): External power connection from QB1, 1+, or QB1c to FreeWire.....                              | 27.50 |
| FW26 (QUFW26): Multi Clip, enables FreeWire to be clipped to belt or accessory bracket .....                 | 9.95  |
| FW29 (QUFW29): 115v external AC adapter .....  | 27.50 |
| FW33 (QUFW33): Y connector for FreeWire TX to connect a TTL adapter plus a local Qflash and FW31 cable ..... | 52.50 |



*FreeWire mounts to the camera shoe with either the Uni-Mod or TTL Adapters.*

# QUANTUM

## FREEWIRE & RADIO SLAVE ACCESSORIES

### *FreeWire and Radio Slave Motor Drive Cords*

| Model | Description   | Compatibility |     |      |      | Price |
|-------|---|---------------|-----|------|------|-------|
|       |   | 405           | 505 | 505i | FW10 |       |
| 451   | Nikon MD2/4/12/15, 8008, 8008s, F4S, (N90, N90S, F5 need Nikon adapter MC25) (QUMDC451)               | Yes           | Yes | Yes  | Yes  | 48.50 |
| 452   | Hasselblad ELM, ELX (QUMDC452)  | Yes           | Yes | Yes  | Yes  | 49.95 |
| 453   | Canon, Olympus, Bronica SQAM, ETR Motor Drive (QUMDC453)  | Yes           | Yes | Yes  | Yes  | 48.50 |
| 454   | Mamiya RZ67, RZ67 II, 645 Super, 645 Pro (QUMDC454)   | Yes           | Yes | Yes  | Yes  | 76.95 |
| 456   | Leica R3, R5, R6, R6-2, R7, RE (QUMDC456)   | Yes           | Yes | Yes  | Yes  | 79.95 |
| 458   | Minolta 5000, 7000, 9000, 5000i, 7000i, 8000i, 5Xi, 7Xi, 9Xi, 700si, Maxxum 7,9 (QUMDC458)            | Yes           | Yes | Yes  | Yes  | 79.95 |
| 459   | Canon EOS A5, A2E, A2, 1, 1N, 620, T90 (QUMDC459)   | Yes           | Yes | Yes  | Yes  | 79.95 |
| 463   | Bronica SQAI (QUMDC463)   | Yes           | Yes | Yes  | Yes  | 48.50 |
| 464   | Rollei 6008, 6006, 6003, 6002, SLX (QUMDC464)   | Yes           | Yes | Yes  | Yes  | 49.95 |
| 465   | Hasselblad 503CW /CXI Motor Drive Cord (QUMDC465)   | Yes           | Yes | Yes  | Yes  | 34.95 |
| 466   | Canon EOS-3, 1V, D30, D60, 10D, 1D, 1Ds (QUMDC466)  | Yes           | Yes | Yes  | Yes  | 84.95 |
| 467   | Mamiya 645AF (QUMDC467)   | Yes           | Yes | Yes  | Yes  | 59.50 |
| FW41  | Two step MD cord for Contax 645, Canon Elan 2, 2E, 7, 7E, Rebel 2000, XI Lite, Hasselblad H1 (QUFW41) | —             | —   | —    | Yes  | 34.95 |
| FW42  | Two step MD cord for Maxxum 7, 9 (QUFW42)   | —             | —   | —    | Yes  | 91.95 |
| FW43  | Two step MD cord for Canon EOS-1v, 3, 10D, 1D, 1Ds (QUFW43)   | —             | —   | —    | Yes  | 76.95 |
| FW44  | Two step MD cord for Nikon D1, D1H, D1X, F5, N90/s, F90x, F100 / Kodak DCS 760 (QUFW44)               | —             | —   | —    | Yes  | 66.95 |
| FW45  | Two step MD cord for Mamiya 645AF (QUFW45)  | —             | —   | —    | Yes  | 66.95 |
| FW46  | Two step MD cord for Canon EOS-1, A2/A2E, T90 (QUFW46)  | —             | —   | —    | Yes  | 66.95 |
| FW47  | Two step MD cord for Pentax 645N and all autofocus SLR Cameras except Z-1p (QUFW47)                   | —             | —   | —    | Yes  | 66.95 |

### *FreeWire and Radio Slave Accessories*

| Model | Description  | Compatibility |     |      |      | Price |
|-------|--|---------------|-----|------|------|-------|
|       |  | 405           | 505 | 505i | FW10 |       |
| 415   | 115v AC Adapter / Charger for 505R or 405R (QUACACRS4R)                                  | Yes           | Yes | —    | —    | 29.95 |
| 438   | Replacement belt clip for 405T transmitter (QUBCRS2T)                                    | Yes           | —   | —    | —    | 9.95  |
| 511   | Replacement belt clip for 505S sender (QUBCRS4T)   | —             | Yes | —    | —    | 9.50  |
| 512   | Replacement dead shoe mounting kit for mounting 505Si to bracket or tripod (QUMKDS505SI) | —             | —   | Yes  | —    | 8.95  |
| 513   | Pole Mount Adapter for Radio Slave 2/4/4i/FW (QUPMRS4RI)                                 | Yes           | Yes | Yes  | Yes  | 19.95 |
| 515   | 115v AC adapter (US) for 505Ri (QUACA505RI)  | —             | —   | Yes  | —    | 27.50 |
| 516   | 220v AC adapter (overseas ) for 505Ri (QUACA505RIX)                                      | —             | —   | Yes  | —    | 26.50 |
| 538   | Replacement belt clip for 505Si Sender (QUBC505SI)                                       | —             | —   | Yes  | —    | 5.95  |

# POCKET WIZARD

## MULTIMAX

FLASHES & ACCESSORIES

294

### Advanced Digital Radio Triggering System

The world's most innovative and advanced digital radio triggering system, the PocketWizard MultiMAX Transceiver features wireless transceiver technology, thus eliminating the need for a separate transmitter and receiver setup. Each MultiMAX can send and/or receive digital signaling by a flip of a switch, similar to personal communicators. Among many advantages, it allows you to select between transmitter or receiver mode as shooting assignments change.

The MultiMAX offers TrueTrigger Confirmation feedback, up to 1600 feet away, without the need for signal repeaters or daisy-chained radios. Selecting which camera or flash zone fires is as easy as pressing a button in "Selective Quad Triggering" mode. The MultiMAX automatically confirms radio triggering on every zone simultaneously, with immediate visual and audible feedback.

Using the optional Flash Confirmation Cable, the transmitter receives a visual and audible confirmation signal that a triggered flash actually fired. Finally, the bundled "Trigger Time Control" software makes it easy and very convenient to create rear curtain sync effects with any camera, add depth of field using multi-pop mode, record events as they unfold using the intervalometer mode, and much more.

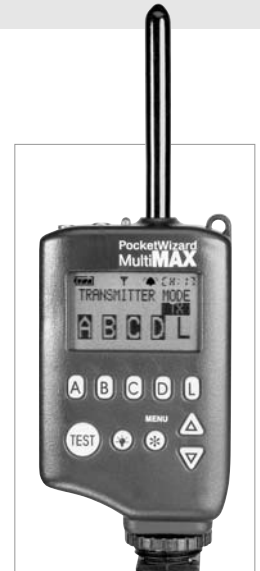

WIPWMMT  
\$295<sup>00</sup>

### FEATURES

#### Wireless Transceiver Technology

The MultiMAX provides the capability to send or receive digital signaling by a flip of a switch, eliminating the need for a separate transmitter and receiver. Easy to read backlit LCD panel indicates which mode the MultiMAX is set for in all lighting conditions.

#### Digital Radio Technology

The MultiMAX incorporates microprocessor controlled full digital communication with built-in selectable 32 complex (16/24-bit) digitally coded channels.

#### True Trigger Confirmation

Because the MultiMAX is a true transceiver, it can automatically confirm radio triggering. Radio triggering confirmation status is indicated on the MultiMAX's (set for Transmitter mode) display panel, up to 1600 feet away or more in all Quad-Triggering zone.

#### Selective Quad-Triggering

Provides the photographer with the convenience to activate or deactivate electronic flash units and or cameras wirelessly in four separately controllable zones (ABCD) without ever leaving the camera position.

#### LCD Display

LCD panel with backlight illumination offers alphanumeric screens with icons: battery status, channel and mode selected, audible status and radio frequency lock indicators.

#### Keyboard

An illuminated soft-touch rubberized keypad offers test, zone (ABCD), up/down, menu and backlight keys. A key lock feature prevents inadvertent setting changes and "KEY-PAD LOCKED" appears on the screen if any keys are pressed while in keypad lock mode.

#### Flash Confirmation Cable

The optional Flash Confirmation Cable indicates that a triggered remote flash actually fired. By



utilizing a shielded high intensity light sensor, which only remains active during the brief radio transmitting time, it confirms only if the attached flash fired or not. Flash confirmation status is sent to the attached receiver and in return sent back to the transmitter. A visual confirmation icon appears on the LCD screen confirming whether the flash fired on all four Quad-Triggering zones.

Flash Confirmation Cable (WIFCMM) ...74.50

### Welcome to Digital Wireless Freedom!

What is Digital Wireless Freedom? It is a new way of working where all your photographic equipment communicates together, wirelessly, so you can work smarter, not harder.

- ◆ Imagine a studio or on-location shoot where unreliable PC cords are a thing of the past
- ◆ Imagine a light meter that wirelessly triggers (selected or all) electronic flashes and measures the light simultaneously, and can even trigger a camera.
- ◆ Imagine triggering cameras, flash units or both simultaneously from behind a camera or from a remote location.
- ◆ Imagine all this equipment protected from high sync voltage
- ◆ Imagine all this wireless technology built into your photo equipment, ready for you to control remotely



EQUIPMENT LEASING AVAILABLE

# POCKET WIZARD

## MULTIMAX

### Trigger Time Controller Features

Utilizing patented microprocessor and software technology, the MultiMAX comes loaded with "Trigger Time Control" software. Used independently or with another PocketWizard, the MultiMAX provides several unique advanced tools for professionals in one small package. With the software, it's easy and very convenient to create rear curtain sync effects with any camera, add depth of field using multi-pop mode, record events as they unfold using the intervalometer mode and much more.

#### Rear Curtain Sync:

Allows you to delay the sync time to fire an electronic flash near the end of the exposure with precision of 1/10,000 of a second. Pre-programmed shutter speeds of 1 to 1/60 of a second are easily selectable. Custom delay settings are possible through the MultiMax's delay time adjustment screen.

#### Precision Delays:

In transmit mode it offers custom set delay times for remote units and or port 2 on the MultiMAX. In receiver mode, precision delay offers delay sequencing or camera/flash synchronization.

**Intervalometer:** Photograph events as they unfold with the desired number of exposures, up to 10,000 exposures and time interval required up to 17 hours 46 minutes.

#### MultiPop (Multiple Flash Exposures):

Provides unattended control of your flash exposures for multi-pops or exposures up to 10,000 flash exposures. Automatically triggers flashes for the desired number of exposures, then waits for the required recycling time (user settable), from 1/100 sec. to 10 minutes.

#### SpeedCycler:

By providing sequential triggering for up to 4 cameras or 4 flashes, the SpeedCycler is ideal for multi-angle camera shots or reducing recycle time by triggering the next flash in line, while the previous flash is charging. Also works on-location shoots with battery-powered electronic flashes. With four MultiMax transceivers connected to the motor ports of the cameras, SpeedCycler sequentially triggers up to four cameras, effectively quadrupling frames per second.

#### Relay Mode:

In this mode the MultiMAX acts as both a transmitter and a receiver triggering both your camera and flash from up to 1600 feet away without an inch of wire. Upon receiving a signal from a remote transmitter, the on-camera receiver instantaneously switches to transmit mode and sends a signal to fire the remote flash in sync with the remote camera.

#### Lag Time Equalizer:

Measures the actual time it takes from the moment the motor driven camera is activated to the time the shutter is open. The Lag Time Equalizer software, measures the delay of your motor driven camera with fine precision accuracy of 1/10,000 sec. resolution, assists you in calibrating another camera, flash or both for simultaneous triggering and exposure synchronizing.

## POCKETWIZARD PLUS

### 4-Channel Digital Transmitters and Receivers

The result of years building sophisticated remote triggering devices, PocketWizard Plus uses the most advanced digital radio system in the industry to deliver impressive range and reliability for the professional photographer. Complex 16-bit digitally coded radio signals deliver a unique code ensuring, the receiver cannot be triggered or "locked up" by other radio noise. The built-in microprocessor guarantees consistent sync speeds even under the worst conditions.

The Plus is built around a streamlined case with a hot shoe mount on the transmitter and a cold shoe on the receiver. Each unit has a 1/4"-20" threaded mount for use with a bracket or clamp, and the hanging lanyard included makes mounting a remote receiver a snap. The transmitter and receiver each run on two AA batteries and provide uninterrupted use for 250-hours. Four digitally coded channels provide reliable triggering for up to four photographers in the same shooting environment. Incorporating PocketWizard's patented digital radio technology, the Plus provides reliable triggering up to 1600' away from the transmitter and receiver. Features like the Local/Both/Remote switch allow you to select which camera or flashes units will fire.



#### PocketWizard Plus Kit (WIPWPK)

4-channel digital radio triggering system kit including one PocketWizard Plus Transmitter, one Receiver, PC-1 camera sync cable and two "AA" alkaline batteries. (May require cable). Compatible with the first four channels of all PocketWizards.....**335.00**

#### PocketWizard Plus Transmitter (WIPWPT)

4-channel digital radio triggering system transmitter. Features local/remote/both selector switch, extended battery life, hot-shoe triggering and 1/4"-20 mounting thread. Includes PC-1 camera sync cable and two "AA" alkaline batteries (may require cable). Compatible with the first four channels of all PocketWizards.....**165.00**

#### PocketWizard Plus Receiver (WIPWPR)

4-channel digital radio triggering system receiver. Features extended battery life and 1/4"-20 mounting thread. Compatible with the first four channels of all PocketWizards (requires cable).....**184.00**

# POCKET WIZARD

## CABLES



### Camera Sync Cables (Camera to PocketWizard)

- |   |   |
|---|---|
| 1' PC to Miniphone<br>Straight Cable (WICPCM1) .....17.95 | 5' Coiled Locking PC to Miniphone Cable (WICPCNLM5)<br>Required for some Nikon lenses.....19.95 |
| 5' Coiled PC to<br>Miniphone Cable (WICPCM5).....17.95    | 10' Straight PC to Miniphone Cable (WICPCM10) .....21.95  |
|   | 16' Straight PC to Miniphone Cable (WICPCM16).....35.95   |

### Electronic Flash Cables

- Straight 10' Miniphone-Male to Miniphone-Female Extension Cable** (WICMMM10) .....19.95
- Straight 16" Miniphone to Triple Household Cable** (WICHHEM16)  
For connecting up to three camera or flashes .....24.95
- Straight 16" Miniphone to Household Cable** (WICHHM16)  
For connecting Comet, Norman, Speedo, Dyalite, Novatron, Lumedyne and Quantum Q-flash.....17.95
- Straight 3' Miniphone to Household Cable** (WICHHM3)  
For connecting Comet, Norman, Speedo, Dyalite, Novatron, Lumedyne and Quantum Q-flash.....17.95
- Straight 10' Miniphone to Household Cable** (WICHHM3)  
For connecting Comet, Norman, Speedo, Dyalite, Novatron, Lumedyne and Quantum Q-flash.....17.95

- 16" Straight Monoplug (1/4") to Miniphone Cable** (WIC.25M16)  
For Balcar, Calumet, Profoto, Bowens, Norman and White Lightning .....17.95
- 3' Straight Monoplug (1/4") to Miniphone Cable** (WIC.25M3)  
For Balcar, Calumet, Profoto, Bowens, Norman and White Lightning .....17.95
- Straight 16" Miniphone Right Angle to Miniphone Straight Cable** (WICMM16)  
For Broncolor and Elinchrom MicroCompact Electronic Flash.....17.95
- Straight 6' Miniphone Right Angle to Miniphone Straight Cable** (WICMM6)  
For Broncolor and Elinchrom MicroCompact Electronic Flash.....17.95
- Straight 16" Sub-Mini to Miniphone Cable** (WICSM16)  
For Canon T-3, Hasselblad SCA 390 Module, Metz 20BC-6, 28C-2, 32CT, MZ, 34CS2, 40MZ, 50MZ, 54MZ-3, 70MZ-3 and 5 and standard SCA adapter.....17.95



- Straight 16" Miniphone to Sub-Mini Cable** (WICSM16)  
For Canon T-3, Hasselblad SCA 390 Module, Metz 20BC-6, 28C-2, 32CT, MZ, 34CS2, 40MZ, 50MZ, and standard SCA adapter .....16.95
- Straight 16" Miniphone to Metz 6-pin Cable** (WICM6PM16)  
For Metz 45CL-1, 45CT/CL-3/4 and 60CT-4.....33.95
- Straight 16" Miniphone to Metz 8-pin Cable** (WICM8PM16)  
For Metz 45CT-5 and 60CT-1/2 .....35.95
- Straight 1' Miniphone to Sunpak Cable** (WICSM1) .....17.95
- Straight 1' Miniphone to Vivitar** (WICVM1) .....17.95

### Motor Drive Cables

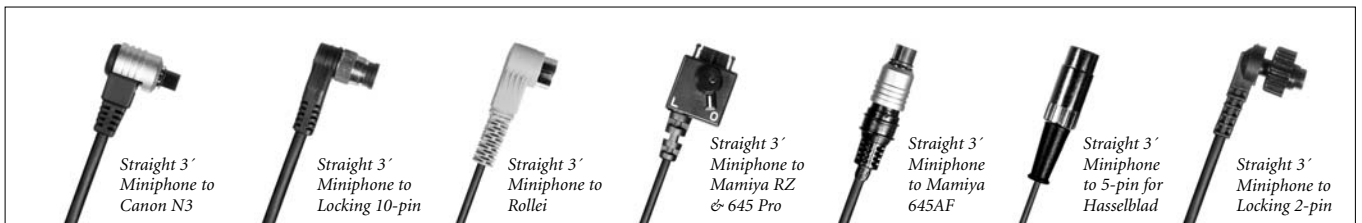

- Straight 3' Miniphone to Canon N3 Motor Drive Cable** (WIMCCE3M3)  
For EOS-3 and EOS-1v .....112.95
- Straight 3' Miniphone to Canon N3 Motor Drive Cable** (WIMCCE1NM3)  
For EOS-1, EOS-1N, A2, A2E .....63.50
- Straight 3' Miniphone to Locking 10-pin for Nikon N90, N90S, F5, F100** (WIMCEN90M3) .....177.50
- Straight 3' Miniphone to Locking 2-pin for Nikon F4, F4S, FE, FM, F3, 8008** (WIMCNM3).....68.50
- Straight 3' Miniphone to Mamiya RZ & 645 Pro** .....94.95
- Straight 3' Miniphone to Mamiya 645AF** .....94.95
- Straight 3' Miniphone to 5-pin for Hasselblad** .....72.95
- Straight 3' Miniphone to Locking 2-pin** .....104.50
- Straight 3' Miniphone to Mamiya RZ- and 645 Pro-TL Series** (WIMCMRZM3) .....94.95
- Straight 3' Miniphone to Mamiya 645AF or 645AF-D** (WIMCM645AFM3) .....94.95
- Straight 3' Miniphone to 5-pin for Hasselblad EL, ELM, ELX** (WIMCHM3) .....72.95



For Any Inquiries Regarding Your Order, Call Our Customer Service:  
(800) 221-5743 • (212) 239-7765 • FAX: (800) 947-2215 • (212) 239-7549



# POCKET WIZARD

## ACCESSORIES

### Pre-Trigger Motor Drive Cables

Designed to keep the camera constantly "awake", these cables have the same effect as holding the camera's trigger button pressed down half-way. A camera will trigger much faster in the "awake" mode, but will also use up more battery power. However, the pre-trigger mode can be switched on or off from the cable itself.

|   |  |
|---|--|
| <b>CM-N3-P</b> (WIPTCC3):<br>For EOS-3, EOS-1v ..... <b>142.85</b>              | <b>RLM3-P</b> (WIPTCR6):<br>For Rollie 3000/6000 series..... <b>124.95</b>       |
| <b>CM-T3</b> (WIPTCCAFQ):<br>For EOS-1, EOS-1N, A2, A2E..... <b>104.50</b>      | <b>RZM3-P</b> (WIPTCMRZ):<br>For RZ-and 645 Pro-TL series..... <b>134.95</b>     |
| <b>N90M3-P</b> (WIPTCNF5):<br>For Nikon N90, N90S, F5, F100 ..... <b>197.95</b> | <b>MAFM3-P</b> (WIPTCM645AF):<br>For Mamiya 645AF or 645AF-D ..... <b>134.95</b> |
| <b>NM3-P</b> (WIPTCNF3): For Nikon F4, F4S, FE, FM, F3, 8008 ..... <b>96.95</b> |  |



### Adapters

- Miniphone to Household Female** (WIHHFMA)  
For standard household sync cord .....**23.95**
- Miniphone to Sub-Mini Female** (WISMFMA)  
For Quantum motor drive cables .....**6.50**
- Straight 16" Trigger Button to Miniphone Cable** (WITBM16)  
To trigger transmitters.....**29.95**

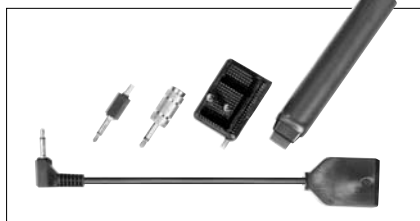

- Straight 3' Trigger Button to Miniphone Cable** (WITBM3)  
To trigger transmitters .....**29.95**
- Miniphone Male to PC Female** (WIPCFFMA)  
For standard PC sync cord .....**14.95**
- Household to PC Cord Adapter** (WIHPCPA).....**33.95**

### WaveSensor



The WaveSensor is a sophisticated and easy to use tool for capturing objects in motion. It uses changes in sound or light to trigger electronic flash units, cameras or both. The WaveSensor has an internal microphone for sound triggering and an internal light sensor, which works with the remote laser included, or many other light sources. The unit has an immediate trigger output and a delayed trigger output linked to an accurate timer for image placement after the system is tripped. The controller has an output

disable circuit to prevent firing strobes or cameras during setup. A retrigger delay timer prevents the system from firing again after the initial event. The WaveSensor can be used to measure the timing of an event from start to finish, or calculate the "Lag Time" for a motorized camera so the strobe fires when the camera has reached "full open". The WaveSensor is capable of triggering from a single drop of water or a fast-paced auto race.

**WS-1 WaveSensor** (803-205): Includes AC adapter, MM1 cable, two MMX cables, laser module, lock-out switch, shock mount and AC adapter .....**CALL**

### Low-Voltage Triggers

- LVT-H Low Voltage Trigger -Household** (WITLVHH):  
Connects between the camera's PC socket and the flash to prevent damage to the camera's sync circuitry due to high triggering voltage from electronic flash. Requires cables .....**77.95**
- LVT-M Low Voltage Trigger -Miniphone** (WITLVMP):  
Connects between the camera's PC socket and the flash to prevent damage to the camera's sync circuitry due to high triggering voltage from electronic flash. Requires cables .....**77.95**

### Mounting Bars

- 4" Isolation Mounting Bar** (WIMB)  
To mount PocketWizard products to super clamps. For convenient placement of PocketWizards and/or isolation from RF (radio frequency) noise. Includes velcro an 1/4-20 male mounting screw.....**16.95**

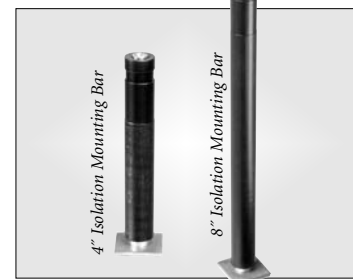

- 8" Isolation Mounting Bar** (WIMB8FW)  
To mount PocketWizard products to super clamps. For convenient placement of PocketWizards and/or isolation from RF (radio frequency) noise. Includes velcro an 1/4-20 male mounting screw.....**18.95**

# WEIN

## BATTERY-FREE PHOTO SLAVES

For over 25 years Wein has offered the widest range of professional flash slaves. Whether you want to trigger a shoe flash from across the room, or a power pack from half a mile away, Wein has a slave that will do the job. Solid, tough and reliable, there is a model for any type of flash connection. Plus, you can leave the batteries home, Wein slaves don't use any.

### PEANUT SLAVES

#### PN "Peanut Slave" (WEPN)

Plugs directly into the Vivitar 283/285; and to other flash units via a standard PC cord. Plugs directly into Nikon SB-24/25/26 by means of PCM Adapter (W990325). Cast-plastic construction with integral standard 'PC' connector for long-term reliability. 100' indoor range .....**19.95**

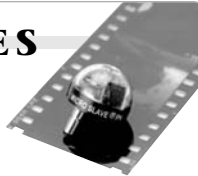

#### PN-XL "Peanut Ultra Slave" (WEPNXL)

Enhanced version in a slightly larger size. Unaffected by strong sunlight. 300' range.....**34.95**



### HOT SHOE SLAVES

#### HS Hot Shoe Slave (WEHS)

With hotshoe and PC terminals. 150' range.....**34.95**



#### HS-XL Hot Shoe Ultra Slave (WEHSXL)

The most sensitive shoe slave ever made, the high performance HS-XL has a range that exceeds 600'. Unaffected by sunlight. With hot shoe and PC terminals.....**79.95**

### MICRO SLAVES

#### L8 Micro Slave (WEL8)

With "H"-prong for all flash units accepting household-style plugs. Rugged and dependable. 150' range.....**29.95**



#### XL8 Micro Ultra Slave (WEXL8)

With "H"-prong plus PC tip. Non-polarized. For all flash units accepting household-style plugs or PC cords. Unaffected by sunlight. 400' range.....**44.95**



#### XL8-E Micro Ultra Slave (WEXL8E)

High performance slave for with monoplug and PC terminals for use with Bowens, Balcar, White Lightning, Photogenic and other units equipped with plug jacks or PC terminal. 400' range.....**59.95**



### ULTRA SLAVES

#### XL Ultra Slave (WEXL)

With "H"-prong and PC terminals. For all flash units accepting household-style plugs or PC cords. 600' range.....**74.95**

#### XL-E Ultra Slave (WEXLE)

High performance slave for with monoplug and PC terminals for use with Bowens, Balcar, White Lightning, Photogenic and other units equipped with plug jacks or PC terminal. 600' range.....**84.95**



#### SSL Ultra Slave (WESSL)

With "H"-prong and PC terminals for all flash units accepting household-style plugs or PC cords. (Supplied with SSR/SSR-JR systems.) 3000' range.....**89.95**

#### SSL-E Ultra Slave (WESSLE)

High performance slave for with monoplug and PC terminals for use with Bowens, Balcar, White Lightning, Photogenic and other units equipped with plug jacks or PC terminal. 3000' range. (Supplied with SSR-E/SSR-E JR Systems.) .....**104.95**



For Any Inquiries Regarding Your Order, Call Our Customer Service:  
(800) 221-5743 • (212) 239-7765 • FAX: (800) 947-2215 • (212) 239-7549

## SSR & SSR-JR

### Studio Remote Controls

High-powered, for big studios or large-scale industrial/architectural work, SSR systems let you fire your slaved strobes without triggering flash. No need to hook up a PC cord to the main flash or use a camera-mounted strobe; the SSR transmitter replaces them both. Mount the compact transmitter on your hot shoe, or connect it to the camera PC terminal; each time you shoot, the SSR transmitter fills the studio with an invisible pulse of light. A super-sensitive SSL Ultra Slave picks up the signal from any direction and fires the main flash, which in turn triggers all other slaved strobes in the setup. Simple, reliable, professional. Excellent for the average-size studio, SSR-JR systems are identical except they offer up to 150' operation.



FLASHES & ACCESSORIES

299

#### SSR Open Channel

##### High Power System with "H" Prong (WESSR)

Includes SSR Transmitter and SSL Receiver (SSL Ultra Slave with "H"-prong and PC terminals for all flash units accepting household-style plugs or PC cords.) Omnidirectional, "Surround-Sync" performance at a distance of up to 600' indoors. Transmitter can be pointed anywhere because line-of-sight is not required. Transmitter uses "AA" batteries for up to 5,000 shots and meets ISO specifications for shutter contact protection. With fresh batteries, transmitter recycle time averages less than a second, so you'll never miss a shot.....189.95

#### SSR-E Open Channel

##### High Power System with Monoplug (WESSRE)

Same as above except with SSL-E monoplug (plus PC) style receiver (W930015). For flash units with phono-plug style sync jacks.....204.95

#### SSR-JR Open Channel

##### Junior System with "H" Prong (WESSRJR)



Includes SSR-JR Transmitter and SSL Receiver (SSL Ultra Slave with "H"-prong and PC terminals for all flash units accepting household-style plugs or PC cords.) Omnidirectional,

"Surround-Sync" performance now up to 150' indoors. Transmitter can be pointed anywhere because line-of-sight is not required. Designed to ISO specifications for shutter contact protection. A 9V battery (not included) powers the transmitter for 100,000 shots. With a fresh battery, transmitter recycle time averages less than a 1/2 second so you'll never miss a shot.....164.95

#### SSR-E JR Open Channel

##### Junior System with Monoplug (WESSRJR)

Same as above except with SSL-E monoplug (plus PC) style receiver (W930015). For flash units with phono-plug style sync jacks.....149.95

### SAFE-SYNC PROTECTORS

#### Safe-Sync with "H" Prong (H in and H out)

Safe-Sync (SSH) with "H" Prong (H in and H out) protects against high sync voltage which can cause arcing and pitting at the shutter contacts, as well as long term circuit damage. Safe-Sync reduces sync voltage to 6 volts, totally isolating the camera from harmful current levels.



Does not interfere with sync circuits below 6V. Features both "H"-prong and PC connections.

Safe-Sync with "H" Prong (WESSQ) .....54.95

#### Monoplug to Monoplug Safe-Sync (WESSMPH)



Protects against high sync voltage which can cause arcing and pitting at the shutter contacts, as well as long term circuit damage. Safe-Sync reduces sync voltage to 6 volts, totally isolating the camera from

harmful current levels. Does not interfere with sync circuits below 6V. With monoplug style of sync cord.....54.95

#### Safe-Sync Hot Shoe to Hot Shoe (WESSHSH)

Mounts Directly to camera hot shoe and has hot shoe on top for flash .....49.95

#### Safe-Sync PC to PC (WESSPC)

In-line PC to PC with coiled cord.....49.95

# WEIN

## PRO-SYNC

FLASHES & ACCESSORIES

300

### Private Channel Remote Controls

If you shoot weddings, events, industrial or other location work, Pro-Sync is for you. A private channel remote control system, Pro-Sync provides cordless, omni-directional remote flash control with virtual immunity to interference. Unlike radio frequency (RF) remote flash control systems, Pro-Sync uses state-of-the-art coded infrared technology to fire remote flash units. Common sources of radio interference, like cellular phones, pagers, and wireless microphones (very common at weddings), can disrupt radio flash signals, but are no threat to Pro-Sync. Because the Pro-Sync signal is encoded, the system cannot be triggered by any flash or light source.



**The Transmitter:** The Pro-Sync transmitter can be mounted on, and fired by any standard camera hot shoe (or connected to a PC terminal for off-shoe use). Just slide the compact transmitter onto your camera and forget it; no cords, no antenna, nothing to clip to your belt.

A pair of "AA" batteries in the transmitter provides power for up to 5,000 shots, with recycle times averaging less than a second; that's faster than almost any flash, so your Pro-Sync is up and ready when you are.

Each time you shoot, the transmitter fires, and an "explosion" of coded infrared lights fills the room, bouncing off walls and around corners. You can't see the signal (neither can your film), but the Pro-Sync receiver sure can.

**The Receiver:** Plugged into your remote flash, the Pro-Sync receiver is in a "standby" mode, waiting for the transmitter signal. Nothing else can trigger the receiver, not even a full-power flash fired inches away. Pro-Sync receivers are incredibly sensitive and can easily pick up the signal from behind backdrops, soft boxes, even around a roomful of wedding guests. They work indoors or out, with a maximum range of 600' (indoors).

The Pro-Sync receiver draws its power from the flash to which it is connected, so there are no batteries to change. Receivers are available with either integral "H" prong or monoplug sync connectors, so they connect directly, cordlessly, to most professional flash units or power packs. For additional versatility, each receiver also has a standard PC terminal.

### PS500-1 Pro-Sync 1-Channel System with "H" Prong

One channel (includes transmitter and "H"-prong type receiver) private-protected system prevents interference from other photographers' flashes. Receiver only responds to discrete transmitter pulse. Operates at ranges up to 600' indoors. Includes 10" miniplug-to-PC coiled cord for non-hot shoe cameras. Universal stainless steel mount clip.

- **Transmitter:** Color-coded On/Off switch. Battery saver circuit provides 5000 firings from two AA alkaline batteries. Ready light, open flash test button. Locking shoe mount; triggers by hot shoe or via PC cord (supplied). Measures 2½ x 3 x 1½", weighs 3 oz. (less batteries).
- **Receiver:** "H"-prong and "PC" connectors. Two velcro strips for mounting when using PC cord. Measures 1½ x 2½ x 7/8", weighs 1.3 oz.

PS500-1 Pro-Sync (WEPS5001).....209.95

#### PS500-1E Pro-Sync

##### 1-Channel System with Monoplug

Same as PS500-1 except with monoplug (plus PC) style receiver (W928120). For flash units equipped with phono-plug style sync jacks.

WEPS5001E.....234.95

#### PS500-2 Pro-Sync

##### 2-Channel System with Monoplug

Same as the PS500-1 except it offers separate channels to allow control over two separate flash systems.

WEPS5002.....319.95

#### PS500-2E Pro-Sync

##### 1-Channel System with Monoplug

Same as above except with monoplug (plus PC) style receiver (W928210). For flash units equipped with phono-plug style sync jacks.

WEPS5002E.....339.95

SYNC-LINK

Lets you use a Pro-Sync transmitter without giving up TTL flash! The Sync-Link frees your hot shoe or PC terminal for a dedicated/TTL flash connection while using any Pro-Sync system. The tiny module velcros to your on-camera flash and senses when it fires, then completes the circuit that triggers your Pro-Sync transmitter. Sync-Link keeps your transmitter "outside the loop," allowing for normal connection of flash to camera. Sync-Link also adds on-camera flash/remote flash switching capability to single channel Pro-Sync systems. (WESLMP).....46.95



EQUIPMENT LEASING AVAILABLE

### PS500-2 PRO-SYNC Wedding Systems



Pro-Sync Wedding Systems with in-line PC hook-up for bracket mounted flash provide Surround-Sync omnidirectional performance and can shoot around corners. Includes "Batteryless" receivers.

- ◆ Full cordless operation, ultra miniature, rugged circuitry, battery-saver transmitter circuits
- ◆ Direct locking shoe-type transmitter mount for all cameras with hot shoes (PC cord included for others).
- ◆ Super strong Lexan receiver housings
- ◆ "Open-Flash" test-fire button on transmitters
- ◆ No awkward antennas, unaffected by sunlight or indoor light
- ◆ 360° sensitivity, absolutely film-safe
- ◆ ISO sync voltage standards eliminate shutter contact wear
- ◆ Infrared pulse tube good for half-million shots (replaceable)
- ◆ Legal worldwide (unlike radio slaves)
- ◆ Immune to all interference (radios, TV's, microwaves), and won't cause interference to radios or TV's. Immune to proximity of metal or cement walls; non-jammable

#### PS500-2W Pro-Sync Wedding System with "H" Prong (WEPS5002W)

Direct receiver plug-in for flash units with standard "H"-prong receptacles, and standard "PC" terminals as well .....349.95

#### PS500-2WE Pro-Sync Wedding System with "H" Prong (WEPS5002WE)

Direct receiver plug-in for flashes with European ("monoplug") receptacles and standard "PC" terminals as well .....359.95

### Wein Slave Accessories

#### "WeinTIP" to PC Cord (WEWTPC)

Replacement. For use with Wein transmitters without a locking foot.....14.95

#### "H"-Prong to Monoplug Adapter (WEPHH)

One piece adapter combining a female "H"-prong socket with a male monoplug. Makes "H"-prong style slaves, receivers and cords compatible with European style monoplug jacks found in Balcar, White Lightning, Photogenic, Bowens, and other flash units.....19.95

#### PC Female to "H"-Prong Adapter (WEPCHA)

A convenient converter that has a molded PC (female) plug and a molded standard "H"-prong female socket connected by a 9" cord.....14.95

#### SB24/SB25/SB26 Adapter (WEPCHM)

A molded, one-piece "male PC" to "male PC" adapter that allows any Wein receiver or slave having a PC terminal to be cordlessly connected to the Nikon SB24, SB25, SB26 sync terminal.....14.95

#### Teleflash Monitor (WETFM100)

The TeleFlash Monitor is a compact, battery operated flash monitor that blinks for about five seconds when the flash fires—providing absolute positive confirmation that a flash unit fired at shutter release—then automatically resets. There are no electrical connections. TeleFlash senses the pulse current entering the flash tube by means of electromagnetic induction. TeleFlash is attached to the flash head cord. It can also be affixed directly to the flash head with Velcro (provided). Any failure is instantly detected. It also reminds you when a remote light is off. Works with on-camera flash as well. Fastens to power cord by means of supplied quick-release nylon clip, or with Velcro tape (supplied). Measures 1½ x 3 x 1" and weighs 1.4 oz. (without required 9v battery) ....49.95



#### Meter-Mate 2 Transmitter (WEMM2)



Provides slaved-flash triggering from any flashmeter equipped with a PC terminal. Micro-sized slave trigger attaches to a convenient location on a flashmeter (with supplied Velcro) and connects to the PC terminal via a short PC cord. The unit operates omni-directionally at a range of up to 100 feet when used with a Wein SSL Ultra-Slave (required for use). Meter-Mate 2 battery (included) powers up to 5000 firings and is user replaceable. Trigger's low-level infrared pulse will not affect exposure readings. Can also be used at the camera to trigger flashes when making the actual exposure.....57.95

#### Photo-Lok Tape Mounting System (WEPL)

A 36" roll of incredibly strong and versatile, single part locking tape that works like Velcro but is several times stronger. Will not wear out and locks itself. It is waterproof and has a super-strong pressure sensitive (permanent) adhesive backing. Will safely hold 10 lbs. per square inch.....24.50

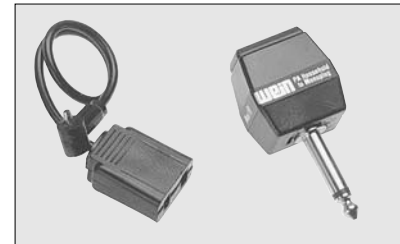

#### Hot Shoe to H Receptacle Adapter (WEHSH)

This adapter has hot shoe connections on top and on bottom, and provides an "H" household socket on the side of the adapter that will allow you to connect accessories with a household type plug (e.g. slaves etc.) .....29.95

# GOSSEN

## EXPOSURE METERS

### Gossen for a Better Image

Light changing in intensity or color at a shooting location could mean frustration or inspiration, which can be a challenge to a photographer. Therefore, it is most important not to leave the exposure to chance or luck. Hand held exposure meters can be useful instruments in creating images, offering possibilities often far exceeding the metering systems built into cameras. Easy incident light measurement with diffusers, or intricate contrast measurements with spot attachments all help to assist the photographer meet the challenge of changing light conditions. Manufacturing exposure meters for over 65 years, Gossen has the expertise and knowledge of the dark and light aspects of photography, and have been helping photographers make the very best of every lighting situation to achieve the perfect exposure.

### DIGISIX

#### Digital & Analog Incident and Reflected Lightmeter

A prime example of high precision and reliability, based on Gossen-specific calibration and German engineering, the ultra-compact Digisix is a feature packed ambient light meter that does much more than just determine exposure.

- ◆ Digital read out in EV is easily transferred to a setting ring where all the shutter speed/f-stop combinations can be read at a glance.
- ◆ Digital LCD read-out and contrast scene read-outs are in 1/3-stop increments. Meter sensitivity range is 0-18EV.

### DIGIFLASH

#### Digital Incident, Reflected and Flash Lightmeter

Offering all the features of the Digisix meter, plus the added benefit of taking flash readings with a range of f/2 - f/32 at 100 ISO, the Digiflash is the first flashmeter to combine both analog and digital displays in an ultra-compact design. Easy and comfortable to use, great for flash and ambient light.

- ◆ Simply enter the desired sync speed, and trigger the flash. The Digiflash will display the resulting EV value measured in the LCD display. The value is then placed precisely under the red indicator. Read the required F-stop on the scale opposite your selected flash sync speed.



#### They Both Feature

- ◆ They are small enough to sit comfortably on your camera's hot shoe (with optional shoe adapter) and sport a digital read-out and analog scale for ambient light levels that can be measured in reflective or incident mode.
- ◆ They also incorporate a functioning clock with alarm (adjustable for both 12 or 24 hour display), a timer for timing long exposures (0 seconds to 30 minutes), plus a precision digital thermometer which measures temperatures (can be set for either Celsius or Fahrenheit) and stores a high and low value.
- ◆ They weigh 1.5 oz and include a carry case, strap and battery.

#### Optional Camera Shoe (GOCSDS)

The optional camera shoe allows the Digisix or Digiflash to be seated in the hot shoe mount of a camera. Includes 1/4" x 20 mounting screw and shoe .....14.95

|                         | DIGISIX (GODS)  | DIGIFLASH (GODF) |
|-------------------------|-----------------|------------------|
| Angle of Coverage       | 25°             | 25°              |
| Apertures               | f/1 to f/32     | f/2 to f/32      |
| EV Corrections          | +/- 3.0 EV      | +/- 3.0 EV       |
| Film Speed              | ISO 6-3200      | ISO 6-3200       |
| Measuring Range Ambient | —               | EV 0 to +18      |
| Measuring Range Flash   | —               | f/2 to f/32      |
| Shutter Speeds          | 1/2000 to 4 min | 1/2000 to 4 min  |
| Battery                 | Lithium CR-2032 | Lithium CR-2032  |
| Dimensions              | 3 x 2 x 1"      | 3 x 2 x 1"       |
| Weight (with battery)   | 1.5 oz.         | 1.5 oz.          |
| Price                   | \$149.95        | \$179.00         |

# GOSSEN

## LUNA-PRO S

### Analog Incident and Reflected Lightmeter

The Luna-Pro S is a classic analog reflected and incident light meter. As a system meter, it will provide correct exposures in any situation. Although the symbols of the Sun and the Moon in the middle of the calculator disc represents the two measuring ranges which can be selected, it is at dusk where the Luna-Pro S performs at its very best. With its low end range value being -4EV, the meter has ample capacity for extreme low-light levels with very long exposures. When a reading is taken and the meter's rocker switch is released, the indicator needle "freezes" making it easy to read off shutter/aperture combinations. Transfer the number indicated by the needle to the corresponding number on the yellow scale, against the yellow index mark and you can read off the required shutter speed, f/stop combination of the calculator dial, it's so easy.



FLASHES & ACCESSORIES

303

- ◆ Continuous, incident, and reflected light measuring
- ◆ Extra large measuring range, divided into high light and low light scales.
- ◆ Scales for shutter speeds, f/stops, exposure values, cine speeds, and the zone system.
- ◆ Setting ring for exposure corrections and extension factors (with a highly visible red reminder indicator).

#### Specifications

- Angle of Coverage: 30° • Apertures: F1 to F90
- Display Metering: Scales with needle
- EV Corrections: -6 to + 6
- Extension Factors: 1.0 to 64
- Film Speed ISO: 0.8/0° to 25,000°
- Ambient Measuring Range: EV -4 to +17
- Shutter Speeds: 1/4000 sec. to 8 hours

Luna-Pro S (GOLPS).....399.95

### Optional Accessories

An assortment of attachments are available to extend the meter's versatility and capabilities.

**Variable Angle Attachment (GOVAA):** This attachment with optical viewfinder reduces the measuring angle to 15° or 7.5°. The desired angle is selected with the sliding switch. Color coded circles in the viewfinder assist in aiming to the spot in the image you wish to measure. Attaching the accessory is quick and simple .....99.95

**Enlarging Attachment (GOEA):** Turn the Luna-Pro S into a specialty meter for the photographic darkroom. Place the measuring aperture of the Enlarging attachment in the projected negative image at the desired spot and the corresponding density value can be measured. The paper grade can be determined by metering the contrast at various areas of the projected image .....79.95

**Fiber Optic Probe (GOFOP):** Even well hidden spots can be reached with this measuring probe. The highly flexible probe is about 15¼" long, the measuring aperture is 3/16" in diameter. This makes the probe very convenient for measuring in those difficult to reach spots, for example in macro photography. Also for measuring on the camera ground glass (ambient only) .....309.95

## MAVOLUX 5032C

### Digital Footcandle and Lux Meter

The Mavolux 5032C is a highly accurate light meter capable of measuring illumination in either footcandles or lux. Candelas/m2 and footlamberts can also be measured with the optional luminance attachment (4141). The Mavolux 5032C is equipped with color correction, so that its spectral response is matched to that of the human eye, in accordance with DIN 5032, part 7, class C. Integrated cosine correction is included in order to assure that oblique incident light is also evaluated correctly. Ideal for industry, trade, electricians, architects, institutes, inspection authorities and also photo and film studios. Even very strong light (e.g. from car headlights) can be measured without any additional accessories.



**Automatic/Manual Measuring Range Selection:** Either lux or footcandles can be selected as a measured quantity. The measuring range is then automatically matched to the quantity. The current measuring range can be locked by pressing a key, or any one of four measuring ranges can be selected manually.

**MAX Function:** The largest measurement value which occurs after this function has been activated is stored to memory in order to determine maximum illuminance or luminance.

**Hold Function:** The current measurement value can be held at the display by pressing the data hold key.

Mavolux 5032C (GOM5032C).....624.95

ORDER & INFO. (212) 502-6340 • FAX: (212) 239-7770 (800) 947-7008  
1-800-290-6750 • www.bhphotovideo.com



# GOSSEN

## LUNA-PRO DIGITAL

### Incident and Reflected Lightmeter

A thin, lightweight, easy-to-use meter for ambient light, the Luna-Pro Digital's front panel features five control buttons that are easily recognizable with large, high-contrast numerals. A built-in optical diffusion dome easily slides to switch between incident and reflected light measurement. When the measuring button is pressed, in the time mode (T), the meter automatically switches into contrast measurement. A series of cursors on the analog scale clearly indicate the range of contrast of the subject being measured. To conserve batteries, the meter has an automatic "power off" function.

- ◆ User friendly, with three controls using only five buttons.
- ◆ Built-in optical diffusion dome easily slides to switch between incident and reflected light measurement.
- ◆ Especially large and high contrast display
- ◆ To conserve batteries, an automatic "power off" function shuts down the meter two minutes after the last reading was taken. However, settings and measurements (shutter, film speed and selected apertures) are stored in memory and can be recalled even after the unit has been shut down.



### Luna-Marine Housing

Underwater housing for the Gossen Luna-Pro Digital F (4023) and Luna-Pro Digital (4022) light meters. For depths up to 120 feet. Includes O-ring, lubricant, and mounting screws. (GOLMH) .....



259.95

|                         | Luna Pro Digital (GOLPD)       | Luna Pro Digital F (GOLPDF)    |
|-------------------------|--------------------------------|--------------------------------|
| Angle of Coverage       | 25°                            | 25°                            |
| Cine Speeds             | 8 to 64, also 25 and 30 for TV | 8 to 64, also 25 and 30 for TV |
| EV Corrections          | -7.8 to +7.9 / 1.0 to 239      | -7.9 to +7.9                   |
| Film Speed              | ISO 3 to 8000                  | ISO 3 to 8000                  |
| Measuring Range Ambient | EV -2.5 to +18                 | EV -2.5 to +18                 |
| Shutter Speeds          | 1/8000 sec to 60 mins          | 1/8000 sec to 60 mins          |
| Battery                 | 1.5 V, battery level display   | 1.5 V, battery level display   |
| Display/Duration        | LCD 1 x 2 in / two minutes     | LCD 1 x 2 in / two minutes     |
| Dimensions/Weight       | 2.5 x 4.625 x 0.75"; 3.3 oz.   | 2.5 x 4.625 x 0.75"; 3.3 oz.   |
| Price                   | \$234.95                       | CALL                           |

## LUNA-PRO DIGITAL F

### Incident, Reflected and Flash Lightmeter



Identical in appearance to the Luna-Pro Digital, the only external difference in the Luna-Pro Digital F is the addition of a flash sync socket. That's because the Luna-Pro Digital F is also a flashmeter (cord or cordless flash operation) for professional photo studio, or for demanding location use. It can easily master the intricacies of balancing flash light to the ambient light. The meter takes two readings at the same instant: The combined reading for flash plus ambient is displayed in digital form and on the analog scale as a pulsing cursor. The ambient reading is also displayed on the analog scale as a constant cursor. The Luna-Pro Digital F can easily calculate multiple flash readings if one flash proves to be insufficient to provide the aperture and depth of field required.

- ◆ In addition to the above, the Luna-Pro Digital F offers all the functions of the Luna-Pro Digital including a built-in optical diffusion dome that slides to switch between incident and reflected light measurement, and an oversized LCD panel that provides direct readout of all critical information. Auto "power off" retains the last reading along with previously stored values of shutter speed, aperture and film speed.



EQUIPMENT LEASING AVAILABLE



# GOSSEN

## LUNA-STAR F2

### Digital Incident, Reflected and Flash Lightmeter

The microprocessor-controlled Luna-Star F2 automatically measures and analyzes both flash and continuous light in a single metering operation and displays the reading clearly, in large, easy-to-read numerals. It also measures both incident and reflected light for particularly accurate exposures, especially with subjects that are either very bright or very dark. It features a rotating head which points the light sensor in any direction. A series of flash synchronization speeds from 1 sec. to 1/1000 sec. lets you control flash exposure shots from different sources of light. The Luna Star F2's outstanding ease of use with just six buttons covers all of the operations required while the ergonomic design allows one-handed use.

- ◆ The rotating measuring head is equipped with a diffuser dome for incident light measurement. The head will rotate through 270° which allows the photographer to see the large display while taking the readings. Remove the incident diffuser dome and you can measure reflected light and subject contrast easily. The combined readout on the display is shown in both digital and analog form and provides a wealth of information.
- ◆ An optional spot attachment transforms the Luna-Star F2 into a 5° spot meter. Incredibly convenient for analyzing the subject contrast or metering the most important areas of the subject. With Parallax correction in the viewfinder for close ups of less than 3'.



FLASHES & ACCESSORIES

305



## DIGIPRO F

### Flash and Ambient Light Meter with Swivel Head

Remarkably versatile to meet the requirements of the professional photographer and dedicated amateurs, the Digipro F is perfect for both film and digital photography. Small enough to fit in your pocket while maintaining a user-friendly interface which can be operated using a single hand, the Digipro F is a high-precision exposure meter for flash and ambient light with a swivel head that makes measuring and reading easy. Measurement modes include incident light, reflected light, contrast measurements and flash metering (cord or noncord) with indication of the share of ambient light.

- ◆ Convenient swivel head facilitates measuring and reading
- ◆ Incident and reflected light mode, with flash and ambient light
- ◆ Flash measurement, cord/noncord, with additional reading of the share of ambient light
- ◆ Multiple flash calculation
- ◆ Digital read-out (LCD) in 1/10 steps
- ◆ Analog indication of the contrast in 1/2 step increments
- ◆ Storing in memory of values measured and preset
- ◆ Preprogramming of exposure corrections
- ◆ Recalling of all suitable shutter speed/aperture combinations for a given reading
- ◆ Shutter speed or aperture priority mode available
- ◆ Comprehensive range of frame speeds (fps) for CINE, including 25 and 30 fps (TV)
- ◆ Automatic switch off, all values stored in memory are maintained
- ◆ Slim, lightweight, but sturdy housing, offers comfortable one hand operation

|                         | Luna-Star F2 (GOLSF2)                 | Digipro F (GODPF)              |
|-------------------------|---------------------------------------|--------------------------------|
| Angle of Coverage       | 30°, 5° with Spot Attachment (option) | 25°                            |
| Cine Speeds             | 8 to 64, also 25 and 30 for TV        | 8 to 64, also 25 and 30 for TV |
| EV Corrections          | -7.9 to +7.9                          | -7.9 to +7.9                   |
| Film Speed              | ISO 3 to 8000                         | ISO 3 to 8000                  |
| Measuring Range Ambient | EV -2.5 to +18                        | EV -2.5 to +18                 |
| Shutter Speeds          | 1/8000 sec to 60 mins                 | 1/8000 sec to 60 mins          |
| Battery                 | 1.5 V, battery level display          | 1.5 V, battery level display   |
| Display/Duration        | LCD 1 x 2 in / two minutes            | LCD 1 x 2 in / two minutes     |
| Dimensions/Weight       | 2.75 x 5 x 1"; 4.25 oz.               | 2.2 x 5.9 x 0.75"; 3.5 oz.     |
| Price                   | \$449.95                              | \$249.95                       |

ORDER & INFO. (212) 502-6340 • FAX: (212) 239-7770 (800) 947-7008  
1-800-290-6750 • www.bhphotovideo.com



# GOSSEN

## STARLITE

### **Waterproof Digital Incident, Spot and Flash Lightmeter**

Top-of-the-line with unrivaled capabilities and multiple functions, the Starlite lets you measure light in any form: flash or ambient, reflected or incident, even a tiny spot. It provides clear, accurate exposure settings, photometric readings or even Zone System ranges for still photography or cinematography, in a compact and rugged, yet stylish, water-resistant unit. The Starlite incorporates three individual meters:

- An exposure meter for ambient and flash
- Cine meter for filming
- Light measuring instrument for illumination intensities and luminances



#### FEATURES

- ◆ Water resistant housing with rubberized edges ensure a comfortable and secure hold
- ◆ Simple operating controls logically positioned, make the meter easy to use.
- ◆ In either spot or incident, the Starlite reads cord, cordless, or multiple flash, ambient or combination light for fill flash calculation.
- ◆ The large, easy-to-read LCD display has an electro-luminescent backlight which automatically turns on in low light.
- ◆ Switches from a narrow angle 1° or 5° spot meter to full function incident meter with 270° swivel head and dual position retractable lumisphere.
- ◆ For cord flash measurements, a flash sync terminal is conveniently placed on the meter front. In addition, a multiple flash mode is incorporated for evaluating and calculating up to 9 flashes.
- ◆ Shutter speeds exposure times in full standard or half-step values
- ◆ Second ISO film speed capacity based on the result obtained for the ISO 1 setting. The corresponding values for ISO 2 will be automatically calculated and displayed
- ◆ In Cine mode, the Starlite provides filmmakers with a full range of features including a preset shutter angle of 180° adjustable in ten-step increments.
- ◆ In the Photometric mode, light intensities and luminance can be measured for both ambient light and flash with results displayed in LUX, footcandle, cd/m<sup>2</sup>, footlambert and more.

#### Multifunctional Swivel Head

A remarkable advantage is the rotary measuring swivel head, a multiple function optical center. The rotary ring at the base of the diffuser can be set at four different modes.

- ◆ Reflected light measurement of a 1° angle through the viewfinder
- ◆ Quick selection at the ring enables the meter to alternate to a 5° angle
- ◆ Incident light measurement: with raised diffuser= spherical characteristics
- ◆ Incident light measurement: with lowered diffuser= flat plane characteristics

#### Six Measuring Methods Available

- ◆ Shutter speed priority—the corresponding f/stop aperture will be displayed
- ◆ F/stop—aperture priority—the corresponding shutter speed will be displayed
- ◆ Exposure value/EV—can be directly used with certain MF lenses
- ◆ Contrast measurements—the brightness range of the subject is determined
- ◆ Averaging—the average value of up to nine single measurements can be calculated and shown in the display
- ◆ Zone System measurements—areas of different brightness are assigned to graduated zones of gray

| Starlite (GOSLM)        |   |
|-------------------------|---|
| Angle of Coverage       | 1° or 5°  |
| Cine Speeds             | 8 to 127 f/s, additional speeds can be adjusted   |
| EV Corrections          | -EV -7.8 to +7.9  |
| Film Speed              | ISO 3.2 to 8000 in 1° DIN increments  |
| Measuring Range Ambient | Incident: EV-2.5 to +18<br>Reflected 1°: f/2.80 to f/128 / Reflected 5°: f/1.4 to f/128 |
| Measuring Range Flash   | Incident: f/1.0 to f/128<br>Reflected 1°: EV 2.0 to +18 / Reflected 5°: EV 1.0 to + 18  |
| Shutter Speeds          | 1/8000 sec to 60 mins   |
| Battery                 | 1.5 V AA or 1.2 V rechargeable  |
| Display                 | LCD panel with backlighting   |
| Dimensions/Weight       | 6.45 x 2.59 x 1.02"; 0.4 lbs.   |
| Price                   | \$644.95  |



# GOSSEN

## ULTRA-SPOT 2

### 1° Spotmeter for Ambient, Flash and Zone System

Photography would be rather boring without the ever changing effects of light and shadows. Nevertheless, it would be advisable to analyze the light conditions at selected, critical areas of the scene and to measure the scene contrast reliably. An all-purpose spotmeter equally adaptable to color or B&W film, the Ultra-Spot 2 is engineered for both ambient and flash lighting, as well as zone system photography. Comfortable designed, with a wealth of technically advanced features and fingertip operating ease, the Ultra-Spot 2 is the precise way to take all of your spot readings.

- ◆ Exceptionally easy to operate using just four buttons and one sliding switch
- ◆ Provides all the information you need at a single glance. When looking through its high-quality optical viewfinder, you can see the subject, a 1° measuring circle and a complete display of exposure information.
- ◆ After several consecutive spot measurements (in time priority) the average will be indicated as a digital value and also on the analog scale as a flashing cursor.
- ◆ In the EV mode resulting shutter speeds and exposure values are displayed digitally. The corresponding f/stop on the analog scale as a constant cursor.
- ◆ Zone system measurements: the zone scale indicates the difference between the brightest and darkest spots measured, which can be compressed or expanded
- ◆ Exposure information is displayed around the viewing field and includes: ambient light readings, f-stop, shutter speed, exposure value, zone or cine readings. In addition, you can average up to ten readings.
- ◆ Offers the ultimate easy solution to using the zone system with a zone scale available. Values measured in the zone system can easily be switched over into the corresponding exposure data of shutter speeds and f/stops.
- ◆ Small gray card stickers included



ULTRA-SPOT 2 (GOUS2)

Cine Speeds: 8 to 64, also 25 and 30 for TV

Display: Viewfinder 15° with 1° measuring field, LCD data display

EV Corrections: -9.9 to +9.9/1.0 to 955

Film Speed: ISO 1 to 80000

Flash Sync Speed: 1/8 to 1/1000 sec; also 1/90

Measuring Range Ambient: EV 1 to +22

Measuring Range Flash: f/2.8 to f/90

Shutter Speeds: 1/8000 sec to 1 hour, also 1/90

Price: \$921.95

### COLOR-PRO 3F Color Temperature Meter

Light for photography is not only defined by its light intensity and luminance, but also by its color composition. The Color-Pro 3F measures the photographic color temperature of flash and ambient light, and indicates the measured results in degrees Kelvin (K). Furthermore, after comparing the color temperature measured with the pre-selected color temperature of the film, it calculates the filter values required to achieve photographs without color casts. The resulting filter values can be expressed as light balancing values in Mired or Kodak Wratten values. In addition, it indicates in CC filter values the correction required, for example, when working with fluorescent lighting.

- ◆ Professional color temperature meter (2000 to 40,000K) for flash and ambient lighting
- ◆ Measures the intensity of the ambient light in lux and of flash light in lux seconds
- ◆ Programmed with three of the most used color temperatures (5500K, 3400K and 3200K). These can be overridden with color temperatures between 2000 and 9900K)
- ◆ Filter values can be expressed in mired or Kodak Wratten values
- ◆ Meter indicates recommended CC filter
- ◆ Button for measuring the light is conveniently placed on the right side of the meter, as are the buttons for changing the values up or down. Buttons for changing the functions left or right are on the front of the meter.



GOCP3F  
\$1196<sup>95</sup>

#### COLOR-PRO 3F SPECIFICATIONS

Flash Sync Speed: 1/2 to 1/500 of a second including 1/90

Light Balancing Filters: -399 to 475 mired scale. Switchable to corresponding wratten filters.

CC Filter Values: 0 to 95 magenta and green

Light Intensity: 10 to 190,000 lux

Flash Power: 5 to 20,800 lux/seconds

ORDER & INFO. (212) 502-6340 • FAX: (212) 239-7770 (800) 947-7008  
1-800-290-6750 • www.bhphotovideo.com



# KONICA MINOLTA

## AUTO METER VF

### Digital Incident and Flash Light Meter

A high-performance photographic exposure meter incorporating a spot meter function, the Auto Meter VF features simplified operation and enhanced functionality. In addition to providing shadow/highlight-based exposure calculations for reflected light measurement, the meter offers a custom setting mode which allows users to specify a desired exposure correction value and shutter speed increments across a broad range of aperture and shutter speeds. It also provides an Analyze function, which conveniently displays the flash/ambient lighting ratio. Ambient or flash, with or without a sync cord, the Auto Meter VF provides unparalleled repeatability and accuracy. It is a meter you can rely on completely, leaving you free to concentrate on the creative challenges at hand. The large, over-sized LCD display shows all the necessary information at a glance. With the shutter speed appearing on the left and the aperture on the right, the LCD display is designed to make viewing easy in all environments.



#### FEATURES

##### Easy-to-Use

Compact and lightweight, the Auto Meter VF comfortably fits into your hand. Rubber buttons are positioned in a straightforward, easy-to-use configuration, which helps keep the meter dust and weather resistant. A rubber-lined frame assures a sure grip while providing additional protection.

##### Operating Ranges

- ◆ Shutter speed range is 1/8000 sec. – 30 min., in 1/3-, 1/2-, and 1.0-stop increments.
- ◆ Film speed range is ISO 3- 8000 in 1/3 stops and cine speeds range from 8 to 128 fps including 25 fps (Europe) and 30 fps (US).
- ◆ The X-sync range is 1/500 – 1 sec.
- ◆ Both f/numbers and EV numbers are displayed digitally to 1/10th-stop accuracy. Analog scale displays f/number readings from f/1.0 to f/90 in 1/2 stop increments.

##### Flash Readings

For flash measurement, select Cord type or Non-Cord type according to measurement conditions. With the Cord setting, when the sync cord of the flashbulb is connected to the sync terminal, the measured value can be displayed by pushing the measurement button. With the Non-Cord type, pressing the measurement button sets the meter to standby for measurement. When the flash is emitted, the Auto Meter VF takes the measurement.

##### Ambient Light Readings

Ambient light readings can be taken by simply setting the film speed and shutter speed, positioning the meter, and then pressing the measuring button to take a reading. By holding the measuring button down, you can take continuous readings throughout the subject area.

##### Memory Mode

The Auto Meter VF's Memory has space for two separate readings. Both stored data and current measured data are displayed simultaneously on the analog scale. Memory marks also indicate the number of readings you have stored. This feature makes it easy to analyze the contrast range of your subject or lighting ratio or to view several separate readings in relation to one another.

##### Analyze Function

If both flash and ambient light are present, the percentage of flash light in the total exposure is automatically displayed on the meter's quadrant-style analyze scale. The flash light proportions are 0% to 100%, in 25% increments. For example: when two quadrants appear, the flash contribution is approx. 50%. The photographer can change the lighting effect by controlling the shutter speed and observing the number of quadrants displayed. This lets you set the exposure to provide the results you want, mainly ambient light to catch the mood, mainly flash to overpower the ambient light, or something in between.

##### Monitor Function

The meters brightness difference function helps you quickly determine lighting ratios and check for consistency of illumination when taking product shots, portraits, etc. Simply measure a reference tone, then press the A\* button. The brightness difference symbol will appear on the LCD readout. Then, measure other areas of the scene. The meter will display the brightness difference in terms of  $\pm$  EV in 0.1 EV increments

##### Exposure Calculation (S/A/H) Functions

The Auto Meter VF is equipped with three exposure calculations: Shadow, Average, or Highlight. Average can be used for both incident and reflected light measurements while the Highlight and Shadow functions can be used for reflected light measurements only.

- The averaging function automatically calculates and displays the average of two stored measurements.
- In highlight mode, the value for the brightest measured point is increased by 2.3 stops (set value) to produce an exposure reading that will render the measured area as a highlight in the photo.
- In shadow mode, the value for the darkest measured point is increased by 2.7 stops (default value) to produce an exposure reading that will render the measured area as a shadow in the photo.



# KONICA MINOLTA

## AUTO METER VF

### Custom Settings

- ◆ The following display modes can be customized according to the photographer's preference. To set the custom display modes, turn the meter OFF and then press the Power button in combination with:
  - The measuring button—to set exposure correction value. Use the Up/Down control to adjust the value up to  $\pm$  in 0.1EV increments.
  - The ISO button—to set shutter speed value. Use the Up/Down control to adjust the value in 1-stop, 1/2-stop, and 1/3-stop increments.
  - The MODE button—to set Time /Cine readout. Use the Up/Down control to select either the TIME or CINE display.

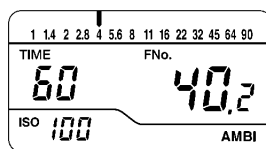

The f-number for proper exposure is displayed on the digital readout - and on the analog scale by a pointer

If the exposure reading is outside the display range of the meter, F No. and "over" or "under" will blink.

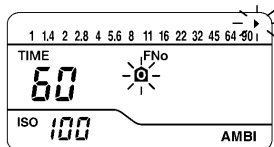

- The Display Selector button (FNo/EV)—to set the aperture display in either full stops with 1/10 – stop increments or direct F number readout, which displays intermediate f-number setting (e.g. f/3.5, 3.6, 3.7, etc). This is useful for many of today's digital cameras.

- ◆ Once you have set one of the above preferences, press the Power button to turn the meter OFF and then turn the meter back ON, which will lock-in the user selection.

### Cine Measurements

For cinematographers, the Auto Meter VF has 10 frame rates: 8, 12, 16, 18, 24, 25 (Europe), 30 (TV), 32, 64, & 128 (Opening angle of 180). To set the meter for cine readings, press the Power button while pressing in the MODE button. Then use the Up/Down key to select CINE mode.

### Price

**Auto Meter VF (MIAM5):** With Spherical Receptor, neck strap and case.....**219.95**

### Auto Meter VF Specifications

**Receptor:** Silicon Photocell 270° rotating receptor with automatic calibration for reflected light receptors.

#### Measuring Modes:

AMBI mode: Ambient light measurement

CORD mode: Flash light measurement with sync cord

NON.C mode: Flash light measurement without sync cord

**Measuring Range: (ISO 100)**

#### Ambient Light:

Incident light: EV -2 to 19.9

Reflected light attachment II: EV 2.5 to 24.4

Viewfinder 5°: EV 2.5 to 24.4

#### Flash Light:

Incident light: FNo.1.0 to 90 + 0.9 stops

Reflected light attachment II: FNo.1.0 to 90 + 0.9 stops

Viewfinder 5°: FNo.1.0 to 90 + 0.9 stops

**Repeatability:**  $\pm$ 0.1 stops

#### Display Range:

F-number (FNo.): 1.0 to 90 +0.9 stops (0.1-stop increments)

Exposure Value (EV): -17 to 40.8 (0.1-stop increments)

Shutter speed: Ambient light: 30 min. to 1/8000 sec. (1-, 1/2- or 1/3-stop increments)

Flash light: 1 to 1/500 sec. (1-, 1/2- or 1/3-stop increments)

Framing rate: 8 to 128 frames/sec.

ISO: 3 to 8000 (1/3-stop increments)

Exposure Difference:  $\pm$ 10.0 (0.1-stop increments)

Analog scale: FNo.1.0 to 90 (1/2-stop increments)

Analyze scale: Flash light proportion 0 to 100% (25% increments)

#### Other:

Power: One AA alkaline battery

Dimensions: 2.3 x 5.8 x 1"; 4.4 ounces

### Optional Accessories



#### 5° Viewfinder (MIVF5):

The 5° Viewfinder features a 5° angle of acceptance and enables spot metering of subjects from a distance. The meter can thus be used to accurately measure small areas of a scene.....**99.95**

#### Flat Diffuser (MIFD):

The flat diffuser is used to measure the lighting ratio between main and auxiliary light sources to determine illuminance values, and to take exposure readings for flat surfaces such as paintings .....**17.95**



#### Reflected Light Attachment II (MIRLA405F):

The reflected light attachment has a 40° angle of acceptance, which corresponds to the angle of view seen with a 50mm lens on a 35mm SLR camera .....**17.95**

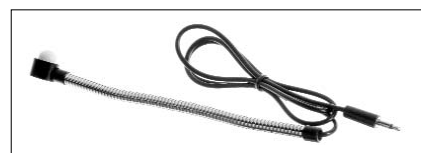

#### Mini Receptor (MIMR):

For photomacrography and close-up work, this remote receptor plugs into the socket on the meter's receptor head. The Mini Receptor can be used to measure incident light in places that are otherwise inaccessible to the meter's receptor head .....**124.95**

#### Sync Cord III (MISC3):



The Sync Cord III is a 5-meter long cord that connects to the meter, flash unit, and camera's sync terminal simultaneously, making possible meter-flash and camera-flash synchronization without changing direction.....**29.95**

# KONICA MINOLTA

## FLASH METER VI

### **Digital Incident, Reflected, Spot and Flash Lightmeter**

The Flash Meter VI sets the standard by incorporating a compact, high-performance 1° spot meter function for the utmost in versatility. However, the Flash Meter VI not only operates as two different meters with a single unit, but it also displays the incident light and reflected light measurement results simultaneously and compares them by using the meter's analog latitude display function. Separate measuring buttons allow taking both normal incident light readings and reflected-spot readings for comparison in the meter's unique LATITUDE display mode.

The built-in spot meter uses a compact, high-precision optical system to provide a bright view while maintaining the meter's compact size. Additionally it features an easy to use diopter dial to ensure precise viewing and comfortable operation even for eyeglass wearers.

Ensuring that the tonal range of the subject will be compatible with the final medium, i.e., film, printing ink, digital, television, etc., has long been a concern to knowledgeable photographers. The Flash Meter VI enables photographers to enter latitude of film or final medium and determine mid-tone standard (18-percent) using an incident reading. Once determined, the photographer can then measure the range of subject tones with the spot meter and use the Flash Meter VI's LCD analog display to determine if they will fit the latitude range and how they will be rendered in the final result.



### **FEATURES**

#### **Compact and Stylish Design**

- ◆ Advanced optical technology enables the construction of a high-precision optical system, which allows for high-precision readings in a compact design. Meter includes spherical diffuser, strap, case and battery.

#### **Latitude**

- ◆ The latitude range based on the standard exposure measured by the flash meter (incident light measurement result) is displayed on the dot indicator of the analog scale. Simultaneously, the spot meter's reading (reflected light measurement result) is displayed on a dot indicator of another analog-like scale. This allows you to visually check how each part of the subject is reproduced on the film by confirming the difference between the measured values for highlight and shadow areas on a subject and the standard exposure.
- ◆ The Flash Meter VI lets you can easily determine the exposure suitable for an intended photographic image, because the exposure decision process can be instantaneously confirmed on the meter's LCD panel.

#### **High-Performance Spot Meter**

- ◆ Incorporates a compact, high-performance 1° spot meter function for the utmost in versatility. Separate measuring buttons allow taking both normal incident light readings and reflected-spot readings for comparison in the meter's unique Latitude display mode.
- ◆ The 1° spot meter uses a compact, high-precision optical system to provide a bright view while maintaining the meter's compact size. An illuminated digital display in the viewfinder indicates F number, EV, and brightness difference information. It also features an easy-to-use diopter control dial to ensure precise viewing and comfortable operation.

#### **Ambient Light Readings**

- ◆ Set the film speed and shutter speed, position the meter, and press either the Spot Reflected or the Incident button to take a reading. Hold the measuring button down to take continuous readings throughout the subject area. The Shutter speed can be specified in the range of 30 minutes to 1/16000 second. The measured value is displayed in the LCD window as digital and analog data.

#### **Exposure Navigation System**

- ◆ Ensuring that the tonal range of the subject will be compatible with the final medium (i.e. film, printing ink, digital, television, etc.) has long been a concern to knowledgeable photographers. The Flash Meter VI enables them to enter the latitude of the film or final medium, determine the mid-tone standard (18-percent) using an incident reading, and then measure the range of subject tones with the spot meter.
- ◆ The photographer can then use the LCD analog display to determine if the measured tones will fit the latitude range and how they will be rendered in the final result. When the readings are outside the range, the Flash Meter VI will blink to call attention to the over/underexposure results.

#### **Flash Readings**

- ◆ With a sync cord connected, pressing either the Incident or Spot measuring button fires the flash and takes an exposure reading. Without a sync cord, pressing Incident measuring button sets the meter to flash standby for 1 minute to allow time for a flash to be fired manually.



**ONE HOUR FREE PARKING**

**AT 349 W. 34th STREET (with purchase of \$100 or more)**

# KONICA MINOLTA

## FLASH METER VI

### Multifunctional Meter

#### Analyze Function:

The percentage of flash light in the total exposure is automatically displayed on the meter's quadrant-style analyze scale. For example when one quadrant appears, the flash contribution is approximately 25%; two 50%; three 75%; four flash is the main illumination source. Change the lighting effect by controlling the shutter speed and observing the number of quadrants displayed.

#### Memory Function:

Up to 10 incident or spot measurements can easily be stored in memory by pressing the M (Memory) button. Incident values stored in memory are displayed on Incident analog scale (left scale); Spot values are displayed on the Spot scale (right scale). The memory data and latest measurement data are retained even when the power button is turned off.

#### Brightness Difference Function:

This function helps the photographer balance lighting or check for uneven lighting when taking product shots, portrait, etc. Simply measure a reference tone, and then press the LATITUDE button to observe the brightness difference symbol (\*), which appears on the LCD readout. Then go measure other areas of the scene. The meter will display the brightness difference on the digital readout in terms of EV in 0.1 EV increments. Incident measurements appear on the main LCD while Spot readings appear in the viewfinder.

### Custom Settings

- ◆ Display mode can be customized according to your preference whenever necessary.
- Exposure correction of  $\pm 10.0$  EV
- Selectable shutter speed setting in 1-stop, 1/2-stop, or 1/3-stop increments.
- Selectable F No. Display mode in conventional full stop with 1/10-stop increments or the f-number
- Direct-reading, which provides intermediate f-number settings (e.g. f/3.5, 3.6, 3.7, etc.).
- Time or Cine mode readings
- Exposure bias adjustment up to  $\pm 10.0$  stops

### Price

**Flash Meter VI (MIFM6):** With Spherical Diffuser, neckstrap and case.....**429.95**

### Exposure Calculation (S/A/H) Functions

- ◆ The Flash Meter VI is equipped with three exposure calculations: Shadow, Average, or Highlight. Average can be used for both incident and reflected light measurements while the Highlight and Shadow functions can be used for reflected light measurements only.
- The averaging function automatically calculates and displays the average of up to 10 stored measurements. To display the average of two readings stored in memory, simply press the S/A/H button.
- In highlight mode, the value for the brightest measured point is increased by 2.3 stops (default value) to produce an exposure reading that will render the measured area as a highlight in the photo. To display the highlight-biased exposure, press the S/A/H button and press the Up/Down control until "H" is displayed on the data panel.
- In shadow mode, the value for the darkest measured point is increased by 2.7 stops (default value) to produce an exposure reading that will render the measured area as a shadow in the photo. To display the shadow-biased exposure, press the S/A/H button and press the Up/Down control until S is displayed on the data panel.

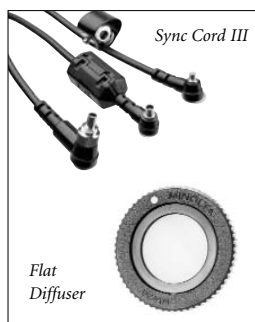

### Optional Accessories

#### Sync Cord III (MISC3):

The Sync Cord III is a 5-meter long cord that connects to the meter, flash unit, and camera's sync terminal simultaneously, making possible meter-flash and camera-flash synchronization without changing direction.....**29.95**

#### Flat Diffuser (MIFD):

The flat diffuser is used to measure the lighting ratio between main and auxiliary light sources to determine illuminance values, and to take exposure readings for flat surfaces such as paintings.....**17.95**

### Flash Meter VI Specifications

**Receptors:** 270° silicon photocell rotating receptor

#### Measuring Modes:

AMBI mode: Ambient light measurement

CORD mode: Flash light measurement with sync cord

NON.C mode: Flash light measurement without sync cord

#### Measuring range (ISO100)

#### Ambient Light:

Incident EV-2.0 to 19.9;

Reflected Light (spot): EV 2.0 to 24.5

#### Flash Light:

Incident-light readings: FNO. 1.0 to 128+0.9 stop

Spot reflected-light: FNO. 2.8 to 128+0.9 stop

**Measuring Distance:** .1.3 m to infinity (for spot measurement)

**Viewfinder:** Single-lens reflect type with fixed focal point (1.2x magnification and -3.0 to +1.0 dioptic adjustment range)

#### Display Range:

Exposure: F1.0 to 128+0.9 stop (0.1 stop increments)

EV: -17 to 40.9 (0.1 stop increments)

Shutter speed (ambient): 30 min. to 1/16000 sec. (1, 1/2, 1/3 stop increments)

Shutter speed (flash): 30 min. to 1/1000 sec. (1, 1/2, 1/3 stop increments)

Frame rate (Opening angle of 180°): 8, 12, 16, 18, 24, 25, 30, 32, 64, 128

ISO: 3 to 8000 (1/3 increments)

Exposure difference:  $\pm 10$  (0.1 stop increments)

Analog scale: FNO. 1.0 to 90 (1/2 stop increments)

Analyze scale: Flash light proportion 0 to 100% (25% increments)

# KONICA MINOLTA

## COLOR METER III F

FLASHES & ACCESSORIES

312

### **Digital Ambient Incident and Incident Flash Color Temperature Meter**

The Color Meter III F is a top-of-the-line professional color compensation meter for ambient and flash with correction value memory, making it easier for photographers to maintain consistent color under various types of illumination. The meter measures the color of the light illuminating the subject and determines the filtration required to correct that illumination for the film in use. When measuring both ambient light and flash, selecting the Color Meter III F's analyze function will subtract the ambient light and display only the measured results for flash light. Measurements can be taken for any of the three major film types: Daylight (balanced to 5500k), Type-A Tungsten (balanced to 3400k), or Type-B Tungsten (balanced to 3200k). Measurement results can be displayed as light balancing and color compensating indexes, Kodak Wratten filter number and CC index, or photographic color temperature (determined color temperature based on film sensitivity). Display of Kodak Wratten filter numbers makes selecting filters quick and convenient. If two Wratten filters are necessary, it displays both numbers. Users can store their own personal correction values for the recommended filtration. Correction values for LB and CC indexes can be stored in any of the meter's nine memory channels to custom tune meter readings for the desired color reproduction. The correction values are added to the initial measured values to calculate the final displayed results.



### FEATURES

#### **Accurate Color Reproduction**

The Color Meter III F makes it much easier for photographers to maintain consistent color under various types of illumination. The meter measures the color of the light illuminating the subject and determines the filtration required to correct that illumination for the film in use.

#### **Ambient Light Measurement**

The Color Meter III F can take measurements of both ambient light and flash. Ambient measurements are taken by positioning the meter and pressing the measuring button; measurements are possible under illumination levels from EV 3 to EV 16.3 at ISO 100.

#### **Flash Measurement**

Flash readings can be taken in either cord or non-cord mode, with selectable shutter speeds from 1/500 to 1 second in full-stop increments. Measurements are possible for flash power levels corresponding to apertures (at the meter position) from f/2.8 to f/180 at ISO 100.

#### **Analyze Function**

When measuring both ambient light and flash, selecting the Color Meter III F's analyze function will subtract the ambient light, and display only the measured results for flash light.

#### **Wide Range of Shutter Speeds**

Select any shutter speed from 1 sec to 1/500 sec. in full stops for flash measurements. Since light for flash photographs usually consists of a combination of flash and ambient light, the Color Meter III F measures this combined light at the selected shutter speed. After measurement, the shutter speed can be changed, effectively changing the ratio of flash to ambient light, and the results will be recalculated for the new shutter speed.

#### **Custom-Tuned Meter Readings**

Film and equipment manufacturers all claim that their particular products are balanced to "daylight" (5500K) or "tungsten" (3400K or 3200K). However, we live in an imperfect world. Films from different manufacturers render color differently, the same film from different batches renders color differently, and the same film batch shot under different lighting conditions renders colors differently. Plus, all light sources are not created equal. Even the sun cannot be relied upon to deliver a perfect 5500K at any time of the day.

The nine memory channels of the Color Meter III F simplify coping with this uncertainty. Once you determine the correct filter pack for the film you are using, you simply enter the difference between your filter pack and the meter's readings into the meter, and the meter will adjust all future measurements accordingly. There are enough channels to permit entering different values for different light sources or for creating filter readings that change normal daylight into warm afternoon sun. If filtration changes due to a new film batch or processor, changing the memorized values is as simple as pressing a button.



**ONE HOUR FREE PARKING**  
AT 349 W. 34th STREET (with purchase of \$100 or more)



# POLARIS

## FLASH METERS

### Film Types and Versatile Display Modes

- ◆ Measurements can be taken for any of the three major film types:
  - Daylight (balanced to 5500K)
  - Type-A Tungsten (balanced to 3400K)
  - Type-B Tungsten (balanced to 3200K)
- ◆ Measurement results can be displayed as LB (light-balancing) and CC (color-compensating) indexes, Kodak Wratten filter number and CC index, or photographic color temperature (determined color temperature based on film sensitivity).
  - The LB index is used for selecting the required amber or blue LB filter; it is the mired difference between the photographic color temperature specified for the selected film type and that of the light source.
  - The CC index is the nominal value of the required magenta or green color-compensating filter.
  - The Kodak filter number (or numbers) of the required light-balancing filter(s) are displayed directly to make selection of the required amber or blue LB filter easy. If two Wratten filters are necessary, the Color Meter III<sup>F</sup> displays both numbers.

#### COLOR METER III<sup>F</sup> (MICM3<sup>F</sup>)

|  |   |
|--|---|
| <b>Receptor Head:</b>                  | Rotating (90° to right/180° to left) head containing three silicon photocells (filtered to red, green, and blue sensitivities appropriate for color film) |
| <b>Display Modes:</b>                  | LB index and CC index; LB filter number and CC index; photographic color temperature  |
| <b>Display Range:</b>                  | LB Index: -500 to +500 mireds<br>CC Index: 200G to 200M<br>LB Filter Number: 80A+80D to 85B+81EF  |
| <b>Photographic Color Temperature:</b> | 1,600 to 40,000K  |
| <b>Correction-Value Range:</b>         | LB: -100 to +100 mireds; CC: 100G to 100M.  |
| <b>Other:</b>                          | Sync terminal   |
| <b>Power Source:</b>                   | 2 AA-size batteries   |
| <b>Measures:</b>                       | 6¼ x 2¼ x 1¼"; 7 oz.  |
| <b>Standard Accessories:</b>           | Case and strap  |
| <b>Price:</b>                          | \$919.95  |

## SHEPHERD / POLARIS

### Polaris Digital Exposure Meter

The Polaris Digital Exposure Meter is a compact flash and ambient light meter that has many features of the more expensive flash meters. A unique multi-flash feature makes it simple to calculate how many times the flash must be fired to achieve a desired f-stop. The Polaris's large LCD display shows both the shutter speed and f-stop in 1/10 stop increments.

- ◆ Compact flash and ambient light meter
- ◆ Measures multi-flash readings
- ◆ Reads f/stops in 1/10 increments

**Polaris Digital Exposure Meter (SHP)**.....169.95



### Polaris 2 Flash Meter

The Polaris 2 is an enhanced version of the original Polaris flash meter. It offers an on command backlight LCD display which is an essential feature when taking readings in a dimly lit situation or when using flash in a studio. By depressing the backlight button located conveniently adjacent to the trigger button, the electro-luminescence light is activated and will stay on as long as the button is depressed. This gives you complete control of the backlight feature regardless of the mode being used.

- ◆ On-command backlight LCD display
- ◆ Custom Program Level function lets you personalize the measuring levels
- ◆ Advanced circuitry lets the meter run on a single AA battery

**Polaris 2 (SHP2)**.....239.95

### Polaris Dual 5 Flash Meter

The Polaris Dual 5 Flash Meter is an enhanced version of the Polaris 2. It features both 5° spot metering capability and a rotating receptor head - as well as an on command backlight LCD display. It is an essential feature when taking readings in a dimly lit situation or when using flash in a studio. By depressing the backlight button located conveniently adjacent to the trigger button, the electro-luminescence light is activated and will stay on as long as the button is depressed. This gives you complete control of the backlight feature regardless of the mode being used, whether it is flash, ambient or combined.

- ◆ On-command backlight LCD display
- ◆ 5° spot metering capability
- ◆ Rotating receptor head

**Polaris Dual 5 Flash Meter (SHPD5)**.....299.95



#### 10° Spotview Attachment (SHSVAP)

Turns your Polaris Flash Meter into a 10° spot meter.....49.95

#### Flat Diffuser Attachment (SHFDAP)

Measures the ratio between main and auxiliary lights to determine luminance values and to take exposure readings of flat subjects such as paintings or documents.....16.95

# SEKONIC

## EXPOSURE METERS

### L-188 Auto Leader

The L-188 Auto Leader is an easy to use, compact, match needle reflected light exposure meter. With its light weight and thin design, it fits into a shirt pocket. The Auto Leader L-188 has a high sensitive CdS cell that allows for lower light measurements. An optional underwater housing is also available.

- ◆ Easy to use, match needle, reflected light exposure meter
- ◆ Lightweight and slim design
- ◆ Highly sensitive CdS cell allows lower light measurements
- ◆ Includes. neck cord, case and battery

|                         |  |
|-------------------------|--|
| <b>Measuring Range:</b> | (ISO 100) EV3 ~ EV18                     |
| <b>Film Speed:</b>      | ISO 6 ~ 12,000 DIN 9 ~ 42                |
| <b>f/stop:</b>          | f/1 ~ f/64                               |
| <b>Shutter Speed:</b>   | 8 sec. ~ 1/2000 sec.                     |
| <b>Movie Scale:</b>     | 8 fps. ~ 128 fps.                        |
| <b>Dimensions:</b>      | 3.2 x 2.0 x .8" (WxHxD), it weighs 2 oz. |



SEL188 \$64<sup>95</sup>



### L-246/L246LX

The L-246 (Footcandle Meter) and L-246LX (Lux Meter) are lightweight, compact direct measurement meters. They both have swivel heads and the simplified scale facilitates easy readings. Both meters have a selenium photocell that eliminates the use of batteries. They both feature lumidics, high slide and neck strap.

|                          |                                     |                                      |
|--------------------------|-------------------------------------|--------------------------------------|
| <b>Measuring System:</b> | Incident light type                 |                                      |
| <b>Measuring Range:</b>  | <b>L246</b>                         | <b>L246LX</b>                        |
| <b>Low Range:</b>        | 0 ~ 100 lux                         | 0 ~ 1,000 lux                        |
| <b>Mid Range:</b>        | 0 ~ 500 lux                         | 0 ~ 5,000 lux                        |
| <b>High Range:</b>       | 0 ~ 5,000 lux                       | 0 ~ 50,000 lux                       |
| <b>Accuracy:</b>         | ± 10%                               |                                      |
| <b>Angle Deviation:</b>  | 30° - 3% or less, 60° - 10% or less |                                      |
| <b>Dimensions:</b>       | 4.4 x 2.3 x 1.1", weighs 4.8 oz.    |                                      |
|                          | SEL246<br><b>\$149<sup>95</sup></b> | L-246LX<br><b>\$149<sup>95</sup></b> |

### L-208 TwinMate

Ideal for the beginning or advanced amateur photographer or as a backup meter, the compact L-208 combines incident and reflected light measurement, and is designed to provide simple, one-handed operation. The printed digits are large and are color coded for easy readings. The L-208 also features a convenient accessory mounting shoe, so you can attach it to the flash shoe of most cameras. This makes it accessible and handily positioned for metering most subjects from the camera position.

- ◆ The smallest light meter to combine incident and reflected light measurement.
- ◆ Hold and Read function grabs and maintains the current reading for 15 seconds
- ◆ Utilizing a CR2032 lithium battery, the L-208 has increased operation time and fewer battery changes. Also offers a battery check button to monitor battery voltage.
- ◆ Sharp 33° angle measurement with guide in reflected mode provides decisive means for choosing values to measure, in comparison to most economical meters with a wider reflective measuring angle.
- ◆ Includes strap, carrying case and battery



SEL208  
**\$89<sup>95</sup>**

|  |   |
|--|---|
| <b>Light Receiving Incident Light:</b> | Lumisphere (flat plate type)                        |
| <b>Reflective light:</b>               | Lens (light receiving angle 33°)                    |
| <b>Measuring Range (100 ISO):</b>      | EV 3 ~ EV 17 incident and reflective                |
| <b>Film Speeds:</b>                    | ISO 12 ~ 12500 in 1/2 stop increments               |
| <b>f/stop Display Range:</b>           | f/1/4 ~ f/32 in 1/2 stop increments                 |
| <b>Shutter Speeds:</b>                 | 30 seconds to 1/8000 second                         |
| <b>EV Display Range:</b>               | 3, 4, 5, 6, 7, 8, 9, 10, 11, 12, 13, 14, 15, 16, 17 |
| <b>Dimensions:</b>                     | 1.8 x 2.6 x 0.95" (W x D x H), weighs 1.4 oz.       |



For Any Inquiries Regarding Your Order, Call Our Customer Service:  
(800) 221-5743 • (212) 239-7765 • FAX: (800) 947-2215 • (212) 239-7549

# SEKONIC

## EXPOSURE METERS

### L-398M Studio Deluxe II

An analog incident ambient light meter with a swivel head and needle lock that facilitates easy and accurate readings, and a memory pointer that retains prior readings. The selenium photocell eliminates the need for batteries. Includes Lumidisc for adjusting illumination contrast and measuring illumination intensity, as well as a Lumigrid for measuring reflected light.

- ◆ Freely rotatable light sensor section for easily performed measurements.
- ◆ Meter stopper mechanism allows operation while hand is released from meter.
- ◆ Meter release mechanism allows the needle to deflect freely. This provides greater convenience when determining light balance.
- ◆ Lumisphere detects the same light as strikes the subject. Since subjects are normally 3-dimensional, according to the lighting conditions, brighter surfaces (highlights) and darker surfaces (shadows) are produced (illumination contrast). The Studio Deluxe II mechanism automatically takes into account the strength of light from all directions, causing the meter to indicate a value applicable to photography. It is thus most convenient for determining typical exposures.

- ◆ Memo pointer enables easier light balance setting.
- ◆ After combining film sensitivity and shutter speed, direct reading slides (optional) can be used for directly determining the aperture value.
- ◆ Uses Selenium photocell as light sensing element, eliminating the need for a battery.



SEL398M \$179<sup>00</sup>

|                                   |   |
|-----------------------------------|---|
| <b>Measuring System:</b>          | Incident light type, reflected light measurement is also possible   |
| <b>Measuring Range (ISO 100):</b> | EV4 ~ EV17 (for incident light)<br>EV9 ~ EV17 (for reflected light) |
| <b>Film Speed:</b>                | ISO 6 ~ 12,000  |
| <b>f/stop:</b>                    | f/0.7 ~ f/128   |
| <b>Shutter Speed:</b>             | 60 sec. ~ 1/8000 sec.   |
| <b>Movie Scale:</b>               | 8 fps. ~ 128 fps.   |
| <b>Dimensions:</b>                | 4.4 x 2.3 x 1.3", it weighs 6.7 oz.                                 |

### L-308S FlashMate

Amazingly small, yet extremely precise, the L-308S is a shirt pocket sized digital ambient/flash meter with built-in sliding lumisphere for reflected and incident light reading. Lumidisc included for contrast or copywork readings. A constant display of information such as ISO, measuring modes and selected settings have been redesigned similar to the L-358 FlashMaster.

- ◆ Offers a choice of Full, 1/2 or 1/3 f-stop increments to compliment digital camera displays
- ◆ Built-in sliding Lumisphere provides easy changeover from incident to reflected light measuring; Lumidisc provided for contrast measuring
- ◆ Cord or cordless flash measuring
- ◆ LCD panel provides large clear display of measured exposure data and set mode
- ◆ Single mode selection button for setting ambient or flash measuring
- ◆ With 1/10th of an f/stop measurement and display, accurate and consistent exposures are a snap—even for digital cameras
- ◆ Energy efficient AA battery operation

- ◆ Supplied with Lumidisc, case, neck cord and battery



SEL308S \$179<sup>00</sup>

|                                   |  |
|-----------------------------------|--|
| <b>Measuring System:</b>          | Incident or reflected for flash and ambient light                                    |
| <b>Photo Cell:</b>                | Silicon photo diode  |
| <b>Measuring Range (ISO 100):</b> | Ambient EV0 ~ EV19.9 incident/reflected<br>Flash f/1.4 ~ f/90+0.9 incident/reflected |
| <b>Film Speed:</b>                | ISO 3 ~ 8000 in 1/3 increments   |
| <b>f/stop Display Range:</b>      | f/0.5 ~ f/90+0.9   |
| <b>Shutter Speed:</b>             | 1 sec. ~ 1/500 sec. for flash light 60 sec. ~ 1/8000 sec. for ambient light          |
| <b>Movie Scale:</b>               | 8 fps. ~ 128 fps.  |
| <b>Exposure Value:</b>            | EV (-) 5 ~ EV 26.2   |
| <b>Repeat Accuracy:</b>           | ± 0.1 EV   |
| <b>Power Source:</b>              | AA battery   |
| <b>Dimensions:</b>                | 4.3 x 2.5 x .9", weighs 2.8 oz. without battery                                      |

# SEKONIC

## EXPOSURE METERS

FLASHES & ACCESSORIES

316

### L-358 Flash Master

Sekonic's most popular compact flash and ambient meter provides great freedom combined with high precision. The L-358 Flash Master features flash/ambient analyzing in all flash modes, and an optional plug-in internal radio transmitter module that eliminates the need for cord connections while measuring flash up to 100' away (when flash units are used with compatible radio receivers). With options such as shutter speeds and apertures selectable in 1, 1/2 or 1/3 stop increments the L-358 makes operation most efficient by matching the displayed f/stop and shutter speed values to the photographer's camera. Additional features include all weather design, nine memory banks, a retractable lumisphere, included Lumigrig attachment for reflected metering and large cool-blue electro-luminescent backlit LCD. The slim L-358 is ideal for professional photographers, cinematographers, and dedicated enthusiasts in the studio, on location or anywhere.



SEL358 \$249<sup>00</sup>



SEL558 \$499<sup>00</sup>

### L-558 DualMaster

The L-558 DualMaster is the first multi-function light meter to offer a 1° spot meter that measures reflected flash output down to an amazing f/2.0 (ISO 100). Its parallax-free lens eliminates erroneous close-up photography light readings. A digital readout through the spot viewfinder displays all-important exposure information. With a turn of a knob the L-558 changes from an incident meter to a reflective spot meter for both ambient and flash measurements, all in one rugged, compact, all-weather housing. Selecting aperture or shutter priority modes or EV is as easy as turning the Jog wheel. Simultaneous evaluation of ambient and flash is displayed in three convenient ways. An easy-to-read illuminated LCD panel, directly displays in full, 1/2 or 1/3-stop increments to match film or digital cameras. Unique features such as meter calibration, exposure compensation and CINE settings offer the flexibility that today's photographer's require.

### L-558R DualMaster

The L-558R DualMaster is the same as the standard L-558 except it also features wireless triggering built-in. Offering all the advantage of wirelessly triggering cameras and flash, the L-558R is compatible with the PocketWizard Plus Receivers and MultiMAX Transceivers. It also triggers earlier PocketWizard radio systems. With PocketWizard wireless technology built-in, it is the world's first remote control light meter right out of the box. There's no optional radio module to purchase and install, it's all in there for you right from Sekonic. With wireless control at your fingertips you can trigger individual cameras and flash units remotely, without wires, using its 16/24-bit, digitally encoded radio signal. The L-558R DualMaster is the most versatile light meter with the right features necessary for digital and film shooters. It's super sensitive sensor measures light beyond the range of today's cameras and puts the power of wireless control in the palm of your hand.



SEL558R \$499<sup>00</sup>



For Any Inquiries Regarding Your Order, Call Our Customer Service:  
(800) 221-5743 • (212) 239-7765 • FAX: (800) 947-2215 • (212) 239-7549

# SEKONIC

## EXPOSURE METERS

### Analyzing Function

A simultaneous reading of flash and ambient light is analyzed. Readings are displayed in three different ways on the LCD. Take ambient, flash or mixed lighting exposure measurements without fumbling with meter modes, switches or different displays.

- Combined readings of flash and ambient
- Percentage of flash in the total exposure
- Simultaneous display of flash, ambient and combined readings on the analog display

### Memory Mode

Up to nine readings can be memorized in incident or spot metering modes independently in both Aperture and Shutter Priority modes. Contrast evaluation and averaging is possible in both modes.

### Illuminated Direct Display

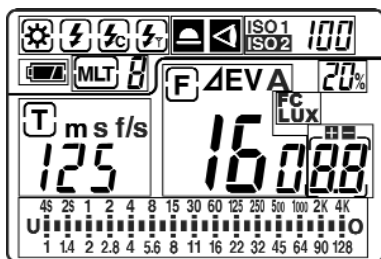

Both shutter speeds and apertures can be displayed in full, 1/2 or 1/3 step increments to accommodate most camera manufacturer's settings. Selecting increments is quick and easy with custom setting DIP switches located in the battery compartment.

### Dual ISO Settings

They let you take a single exposure measurement and display the f-stop and shutter speed for two different ISO film speeds such as negative film and Polaroid proofing film. The second ISO setting is also ideal for calculating exposure compensation such as filter factors without having to change the original film speed settings.

### All Weather Design

All buttons, switches and compartments are sealed and the meter housing has been constructed with durable, rugged conditions in mind. Ideal for shooting in sandy, rainy or humid conditions.

### L-358 ONLY

Optional 1°, 5° or 10° spot finders easily attach to the meter in place of the removable Lumisphere. Each spot finder features a Parallax-free swiveling eye-piece for precise spot metering. A Lumigrad (reflected light receptor) is included for reflected light measurements.

### Retractable, Removable and Rotating Lumisphere

- ◆ Quickly change from standard incident (hemispherical or Lumisphere in up position - 180° angle) to cosine corrected (narrow - 90° angle) light readings with a turn of a ring. Ideal for portrait lighting it offers brightness evaluation or light ratio setups and is also ideal for flat art work light measurements.
- ◆ With the 270° rotating Lumisphere, reading the display is possible while positioning the Lumisphere toward the light or the subject without ever losing sight of the meter's display.

### Full-Featured Flash Measurements

- ◆ Cord Flash Mode— for use with standard PC sync cable
- ◆ Multiple Flash Mode— unlimited cumulative measurement of multiple triggered flash
- ◆ Cordless Flash Mode— measures manually triggered flash without a PC sync cable
- ◆ Radio Triggering Mode— wireless triggering and measuring of flash up to 100' away

### Wireless Freedom

Electronic flash units and/or cameras can be triggered wirelessly from either the L-558R or from the L-358 and L-558 equipped with RT-32 optional plug-in, multi-channel digital radio transmitter. No more tripping over sync cords, or fumbling with PC connectors. Compatible with all PocketWizard Digital Radio Receivers, these meters can simultaneously trigger and measure flash units up to 100 feet away. You can also select through the meter's software, "Quad Triggering mode" which provides you with up to four zones of lighting control remotely. Now you can individually measure several flash units wirelessly with the touch of the meter's measuring button, without walking over to each light and turning them on or off. You can even trigger motor driven cameras from the meters.

### Additional Features

- ◆ Independent incident and reflected exposure compensation of up to  $\pm 9.9$  EV (in 1/10 steps) can be easily set for custom film exposure corrections or for bellows extension actors. With the calibration compensation setting of  $\pm 1.0$  EV (in 1/10 steps), matching built-in camera meters or other handheld meters is a snap. The L-558 and L-558R also offer a filter compensation setting of  $\pm 5.0$  EV (in 1/10 steps) for filter factor compensation.
- ◆ They all feature an extra large, cool-green-illuminated full-information LCD panel that displays the complete range of readouts and modes as well as battery condition.

### L-558/L-558R ONLY

The L-558/L-558R feature a rectangular 1° parallax-free spot viewfinder. In dim or bright light situations, the L-558's spot viewfinder displays f-stops, shutter speeds and more. The built-in spot meter measures both reflected ambient, flash or combined lighting. The optical finder also features an eyepiece with an adjustable diopter.

The L-558/L-558R include a broad range of custom settings so pros and enthusiasts can tailor it to their individual working methods.

# SEKONIC

## EXPOSURE METERS

| Specifications           | L-358   | L-558   | L-558R           |
|--------------------------|---|---|------------------|
| Meter Type               | Digital Meter for Ambient & Flash   | Dual readout, Digital meter for ambient and flash   |                  |
| Light Receiving Method   | Incident and reflected light  |   |                  |
| Incident                 | Convertible to flat diffuser (Lumisphere in down position)  |   |                  |
| Reflected                | Lumigrad 54°  | 1° Spot lens, metering distance 3.3ft~  |                  |
| Light Receptors          | Silicon Photo Diode   | 2 Silicon Photo Diodes  |                  |
| Ambient Light Mode       | Aperture priority, Shutter speed priority, EV metering values   |   |                  |
| Flash Metering Modes     | With sync cord, without sync cord, with radio triggering (cumulative, non-cumulative)                       |   |                  |
| Radio Triggering         | Optional  | Optional  | Built-in         |
| Radio Technology         | Complex 16/24 bit digitally coded (PocketWizard ready)  |   |                  |
| Range / Channels         | 100ft from transmitter to receiver / 1-16 channels std. 17-32 "Selective Quad Triggering"                   |   |                  |
| Radio Frequency          | Channels 1-16 344 mHz, 17-32 346.5 to 354 mHz   |   |                  |
| Measure Range Ambient    | EV -2 to +22.9  | EV -2 to +22.9  | EV -2 to +22.9   |
| Measure Range Flash      | f/1.0 to f/90.9   | f/0.5 to 161.2 (approx. f/175 with 1° spot)   |                  |
| Film Speeds              | ISO 3 to ISO 8000 (in 1/3 steps)  |   |                  |
| f/Stop Display Range     | f/1.0-f/90  | f/0.5 - 161.2 (full, 1/2 or 1/3 steps)  |                  |
| EV Range (ISO-100)       | EV(-) 9.9 to EV36.1 (1/10 steps)  |   |                  |
| Shutter Speed - Ambient  | 30 minutes to 1/8000 second (full, 1/2 or 1/3 steps)  |   |                  |
| Shutter Speed - Flash    | 30 sec. to 1/1000 second (Full, 1/2 or 1/3 steps; Plus flash speeds: 1/75, 1/80, 1/90, 1/100, 1/200, 1/400) |   |                  |
| Cine Speeds              | 2 - 360fps, (fps at a 180°)   |   |                  |
| Memory Function          | Up to 9 readings on analog scale with memory recall   |   |                  |
| Multiple Flash           | Unlimited flash readings  |   |                  |
| Flash analyzing function | % of flash in total exposure 0-100% in 10% increments   |   |                  |
| Average function         | Flash and ambient reads up to nine measurements   |   |                  |
| Exposure Calibration     | +/- 1.0 EV  | +/- 1.0EV for incident and reflected independently (in 1/10th steps); Exposure Compensation +/- 9.9EV; Filter compensation +/- 5.0EV for incident and reflected independently (in 1/10 steps) |                  |
| Brightness Difference    | in 1/10 stop incr.  | +/- 9.9EV (in 1/10th stops)   |                  |
| Flash to Ambient Ratio   | Yes   | Yes; Displays % of flash in 10% incr.   |                  |
| Power Source             | CR123A lithium battery (3v)   |   |                  |
| Auto Shut-Off            | Shuts down after 20 minutes of non-use  |   |                  |
| Dimensions (WxHxD)       | 2.4 x 6.1 x 1.46"   | 3.5 x 6.7 x 1.9"  | 3.5 x 6.7 x 1.9" |
| Weight                   | 5.4 oz.   | 9.5 oz.   | 9.5 oz.          |
| Order Code #             | SEL358  | SEL558  | SEL558R          |
| Price                    | \$249.00  | \$499.00  | \$499.00         |

### Optional Accessories



**Zoom Lens Hood (SEZLHL608)**  
For the L-558 and L-608. The Zoom Lens Hood prevents erroneous light measurements caused by lens glare. It also acts as a step-up ring for attaching filters to the front of the zoom lens (up to 4.5mm filter thread) .....**29.95**

#### Mini Light Receptor Unit (SELRUML608)

For the L-358 and L-608. Designed for photomacrography and close-up work, this remote receptor plugs into the accessory socket on the L-358 and L-608. The Mini Light Receptor can be used to measure incident light in small places that are otherwise inaccessible to the meter's receptor head.....**149.95**



**Spot Viewfinders (L-358)**  
For the L-358. All-weather designed non-parallax 1°, 5°, 10° (angle of acceptance) spot metering viewfinders offer precise reflected light measurements of both flash and ambient light.  
1° Spot Viewfinder (SEVF1D) .....**159.95**  
5° Spot Viewfinder (SEVF5D) .....**139.95**  
10° Spot Viewfinder (SEVF10D) .....**139.95**

#### Microscopic Attachment (SEMAL608)

For the L-358 and L-608. Allows measurement through microscope eyepiece .....**19.95**



#### Film Plane Attachment (SE35FPAL608)

For the L-608. Allows measurement at 35mm camera film plane .....**53.95**



#### Gray Card (SEGC)

Measuring the light reflected from this 18% gray card provides accurate exposures regardless of reflection ratio of the subject and surroundings. Small, folding, pocket-size. Approx: 4 x 5" ..**34.95**

#### Synchro Cord (SESCZ)

Specially designed "T" style PC cord (3 leads) allowing for easy flash connections between the meter, camera, and flash unit. Extra long, 15-foot length is compatible with all Sekonic flash meters .....**29.95**



**EQUIPMENT LEASING AVAILABLE**

# SP/SPECTRA/VISATEC/WEIN

## EXPOSURE METERS

### SP STUDIO SYSTEMS

#### SP PortaFlash (SPFM)

A compact, economical, and easy-to-use flashmeter, the SP Portaflash has an 8-stop range, f2.8 - f32 (with ISO 100 film), over/under range indicators, and cordless or cord triggering. Accurate to 1/3 stop. Also features Auto off battery saver circuit and low battery indicator .....**99.95**



### SPECTRA CINE



#### Spectra Professional IV-A

The Spectra IV-A is the most comprehensive, technologically advanced and reliable exposure meter for cinematographers, lighting designers, videographers and professional still photographers. Compact and user-friendly, it provides an easy, economical means of making highly accurate measurement of indoor and outdoor light levels. It measures footcandles, lux and instantly calculates Contrast Ratio, Averaging and can store up to 2 readings. Measurement results are displayed on an electroluminescent backlit custom LCD. It has

a digital f/stop range from f/0.35 to f/128 in 1/10 stop increments and an analog bargraph range from f/0.7 to f/45 in 1/3 stop increments. It includes a Spectra 1° Photospot that converts the meter into a high-sensitivity 1° spotmeter for narrow-angle reflected-light measurements. Readings are displayed in reflected f/stop or in footlamberts in luminance mode. Available in Black (SPSSB), Blue (SPSSBL), Green (SPSSG), Red (SPSSR) and Yellow (SPSSY) .....**1055.95**

#### Candela II/IIA

The Spectra Candela II is designed for simple one-handed convenience. Simply pressing one push button enables the light level to be measured and displayed on a easy to read digital LCD, which reads out directly from 0.1 to 70,000 foot candles and 1 to 100,000 lux; a range which encompasses illumination levels from dim indoor lighting to extremely bright sunlight. The Candela II can also store and recall up to two readings with the memory/recall function whereas Candela IIA can also measure foot candles, lux and instantly calculates Contrast Ratio, Averaging and can also store up to 2 readings. Measurement results are displayed on the electroluminescent back-lit custom LCD.

**Candela II (SPC2010EL) ....357.50** **Candela IIA (SPC2010ELA) ...412.50**

**Candela IIA with Detachable Head (SPC2010ELDHA) .....442.95**

**Candela IIA with Lowlight Sensor (SPC2010ELLSA) .....589.95**



### VISATEC

#### FM1000 - Flash Meter 1000 (VIFM1000)

The FM1000 is a basic flash and ambient light meter with a two-digit LED display. A two-digit LCD indicates light values. It offers a choice of four shutter speeds (1/60 to 1/500, can be used as a slave unit and has a push button memory recall.....**234.95**



#### DFM - Digital Incident Flash Light Meter (VIDFM)

The DFM is a digital incident flash meter with an exceptionally large measuring range of more than 14-2/3 stops. The DFM is well-suited for low capacity flashes as well as for very high capacity studio flash equipment. The 1/3 f/stop increments are easily readable on the large digital display. The measuring speed of the meter is a fixed 1/60th of a second. However, any ambient light present is also included in the flash measurement. When put into MULTI LOW or MULTI HIGH, any number of flashes of different intensity may be measured. The memory of the DFM will record each input of light and indicate the accumulation value on the display. There is a HIGH and LOW range of measurement which overlap by two f/stops. The horizontal lines on the display next to the number indicate either a 1/3 or 2/3 stop difference .....**467.50**



### WEIN

*These classic flashmeters remain as popular as ever. They are accurate, rugged, reliable and inexpensive. Still the best value around. Ideal for students, schools and studios. Operation is totally cordless. Designed for manual, non-TTL applications.*

#### WP-500B Standard (WEWP500B)

The Wein WP-500B Standard is an economical analog flash meter that reads incident flash light from electronic flash and integrates it with the ambient light to provide an accurate exposure light reading in direct f-stops up to f/22 (accurate to 1/3 stop). The reading is permanently recorded until the meter is manually reset.....**89.95**



#### WP-100 Deluxe (WEWP1000)

The WP-100 Deluxe utilizes all the features of the WP-500B, except the f/stop range is increased to f/90, and the meter readings are accurate to 1/6 of an f/stop .....**129.95**









# The 35mm SLR Photo SourceBook

## Section 4

### Filters & Accessories

|                              |         |
|------------------------------|---------|
| B+W .....                    | 322-345 |
| Cokin .....                  | 346-357 |
| Heliopan .....               | 358-363 |
| Hitech.....                  | 364-371 |
| Hoya .....                   | 372-387 |
| Kodak.....                   | 388-389 |
| Lee .....                    | 390-403 |
| Optiflex.....                | 404-405 |
| Singh-Ray .....              | 406-407 |
| Tiffen.....                  | 408-419 |
| Step-Up/Step-Down Rings..... | 420-421 |

## UV FILTERS

### The B+W Difference

Most other filter manufacturers start with ordinary window glass that has been poured in thin sheets and cooled quickly, introducing internal flaws. B+W filters, on the other hand, start with a cylinder of Schott German optical glass from which the filters are diamond cut, precision ground, and then polished to ensure flatness on both surfaces and uniform thickness throughout. Every B+W filter is interferometrically tested for plane parallelism. This process is used routinely by the world's leading lens makers, but only rarely by filter manufacturers.

To reduce unwanted reflection and lens flare, which can seriously degrade the image contrast and resolution, B&W gives their filters a single coating on both sides. This guarantees that the high MTF performance of your lens is maintained exactly as the lens manufacturer intended it.

You can also purchase filters with Multi Resistant Coating (MRC).

Developed by B+W, Multi Resistant Coating (MRC) technology is not only an enhanced process that assures virtually complete elimination of surface reflections on both sides of each filter —maximizing light transmission— it also offers an extraordinary hardness that minimizes scratching and its water- and dirt repelling surfaces facilitate the care of filters. Finally, most B+W screw-in filters are mounted in a matte black, corrosion-free brass ring, further reducing surface reflections and minimizing distortion or binding of the filter to the lens, even during rapid temperature changes. All filters must pass manual as well as automated tests to insure that each and every one that leaves the factory meets B&W's critical standards.

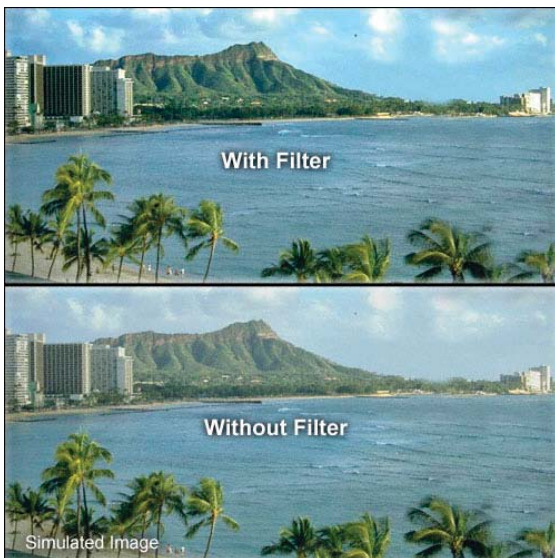

### UV 010 Filters

A UV filter blocks the invisible UV component of light from the sky, which can cause blur and causes many color films to react with a blue cast. UV Filters are ideal for when shooting in high altitudes (in the mountains), by the sea and in regions with very clean air. The pictures gain brilliance and disturbing blue casts are avoided. Because the glass is colorless, color rendition is not altered, aside from the elimination of the unwanted blue cast, and no increase in exposure is required. Filter factor is 1.0.

Good lenses are far more expensive than filters, therefore it makes good sense to attach a filter to protect the lens' sensitive front element. The colorless, multi-coated UV 010 is ideal, protecting the lens' front element against dust, flying sand, sea water spray and the like, and it can be kept on the lens at all times. Taking it a step further, the extremely hard MRC coating optimizes the protective effect and facilitates cleaning in case of accidental fingerprints or when the surface becomes soiled. This, by the way, is all the more important with digital cameras, whose picture quality, because of the shorter focal length of their lenses, is much more sensitive to dirt on the front element of a lens!

UV filters are also available in Wide Angle (they have a larger front diameter than the screw-in diameter to eliminate vignetting on wide angle lenses, and can only be used without a lens hood), and SLIM mounts (no front threads) for even wider-angle

photography without vignetting. Wide Angle and SLIM filters are also available in a choice of multi-coated or MRC.

## UV FILTERS

### UV HAZE 010 FILTERS

| Filter Size (mm)           | 30.5  | 35.5  | 37    | 39    | 40.5  | 43    | 46    | 48    | 49    | 52    | 55    |
|----------------------------|-------|-------|-------|-------|-------|-------|-------|-------|-------|-------|-------|
| UV Haze 010 #BWUV()        | 24.95 | 24.95 | 24.95 | 24.95 | 24.95 | 24.95 | 24.95 | 24.95 | 19.95 | 19.95 | 22.95 |
| UV Haze 010-W/A #BWUV()EW  | —     | —     | —     | —     | —     | —     | —     | —     | 49.95 | 49.95 | 56.95 |
| UV Haze 010-SLIM #BWUVS()  | —     | —     | —     | —     | —     | —     | —     | —     | 44.95 | 44.95 | 49.95 |
|                            |       |       |       |       |       |       |       |       |       |       |       |
| UV 010 MRC #BWUVMC()       | 39.95 | 39.95 | 39.95 | 39.95 | 39.95 | 39.95 | 39.95 | 39.95 | 29.95 | 29.95 | 32.95 |
| UV 010 MRC-W/A #BWUVMC()EW | —     | —     | —     | —     | —     | —     | —     | —     | 59.95 | 59.95 | 77.95 |
| UV 010 MRC-SLIM #BWUVMCS() | —     | —     | —     | —     | —     | —     | —     | —     | 52.95 | 52.95 | 69.95 |

### UV HAZE 010 FILTERS

| Filter Size (mm)           | 58    | 60    | 62    | 67     | 72     | 77     | 82     | 86     | 95     | 105    | 112    |
|----------------------------|-------|-------|-------|--------|--------|--------|--------|--------|--------|--------|--------|
| UV Haze 010 #BWUV()        | 24.95 | 39.95 | 29.95 | 36.95  | 46.95  | 52.95  | 72.95  | 79.95  | 109.95 | 134.95 | 174.95 |
| UV Haze 010-W/A #BWUV()EW  | 67.95 | —     | 76.95 | 79.95  | 92.95  | 94.95  | 112.95 | 119.95 | 139.95 | 169.95 | —      |
| UV Haze 010-SLIM #BWUVS()  | 64.95 | 82.95 | 69.95 | 69.95  | 79.95  | 84.95  | 97.95  | 106.95 | 142.95 | 164.95 | —      |
|                            |       |       |       |        |        |        |        |        |        |        |        |
| UV 010 MRC #BWUVMC()       | 34.95 | 59.95 | 42.95 | 49.95  | 62.95  | 79.95  | 104.95 | 109.95 | 154.95 | 179.95 | —      |
| UV 010 MRC-W/A #BWUVMC()EW | 89.95 | —     | 99.95 | 109.95 | 124.95 | 124.95 | 144.95 | 159.95 | 179.95 | 219.95 | —      |
| UV 010 MRC-SLIM #BWUVMCS() | 79.95 | 99.95 | 89.95 | 96.95  | 107.95 | 112.95 | 124.95 | 142.95 | 159.95 | 192.95 | —      |

### UV HAZE 010 FILTERS

| Filter Size (mm)           | 122    | Bay 1 | Bay 2 | Bay 3 | Bay 6  | Bay 50 | Bay 60 | Bay 70 | Bay 104 | Series 7 | Series 93 |
|----------------------------|--------|-------|-------|-------|--------|--------|--------|--------|---------|----------|-----------|
| UV Haze 010 #BWUV()        | 179.95 | 32.95 | 37.95 | 42.95 | 154.95 | —      | 132.95 | 149.95 | —       | 27.95    | 84.95     |
| UV Haze 010-W/A #BWUV()EW  | —      | —     | —     | —     | —      | —      | —      | —      | —       | —        | —         |
| UV Haze 010-SLIM #BWUVS()  | —      | —     | —     | —     | —      | —      | —      | —      | —       | —        | —         |
|                            |        |       |       |       |        |        |        |        |         |          |           |
| UV 010 MRC #BWUVMC()       | —      | 42.95 | 49.95 | 56.95 | 194.95 | —      | 144.95 | 174.95 | —       | 42.95    | 119.95    |
| UV 010 MRC-W/A #BWUVMC()EW | —      | —     | —     | —     | —      | —      | —      | —      | —       | —        | —         |
| UV 010 MRC-SLIM #BWUVMCS() | —      | —     | —     | —     | —      | —      | —      | —      | —       | —        | —         |

1. In the parenthesis insert the filter size. For example, a 67mm UV Haze 010-W/A would be BWUV67EW.
2. For Bay sizes insert just the letter B and the number. For example, UV Haze 010-SLIM in Bay 60 is BWUVSB60.
3. For Series 7 and 93, insert just the letter S and the number. For example, UV Haze 010 in Series 93 is BWUVS93.
4. Series 5.5, Series 6, Series 8 and Series 9 are also available special order.



## NEUTRAL DENSITY FILTERS

B+W neutral density filters are made out of neutral gray Schott NG-glass. They block the entire visible spectrum evenly and allow light reduction without influencing color rendition or contrast. Sometimes it is necessary to cut down the amount of light with neutral density filters when working with high-speed films. For example, the B+W 102 filter allows exposures with ISO 400/27 degree film as if it were 100/21 degree film. It is often used to portray a subject against an out of focus background. A neutral density filter comes in handy if you would like to increase the aperture more than the light situation and camera capabilities permit. They are also good for the long exposures which are necessary for a blur-effect or zooming during the shot.



### Charming Selective Sharpness:

Modern high speed lenses produce bright viewfinder images in reflex cameras and make fast shutter speeds possible in all types of cameras, even with slow speed films or under poor light conditions. But their larger apertures can also be used as an interesting creative element.

At wide apertures the depth of field is reduced so much that eventually only the main subject will be rendered sharply, whereas the foreground and background will be unsharp. This also focuses the attention on the main subject in a creative sense, it draws the attention of the viewer as if by magic, relegating everything else to the background. In intense brightness, however, with high-speed film or a short focal length (with correspondingly higher depth of field), using a large aperture to achieve the desired selective sharpness effect may not be possible without incurring over-exposure. This when B&W neutral density filters provide the solution.

When the shutter speed is reduced by two or three steps instead of opening the aperture, for instance, a neutral density filter can be used for equally creative blur effects with moving subjects.

| Neutral Density Filter Number | Filter Factor | Reduction f-stop | Density |
|-------------------------------|---------------|------------------|---------|
| 101                           | 2             | 1                | 0.3     |
| 102                           | 4             | 2                | 0.6     |
| 103                           | 8             | 3                | 0.9     |
| 106                           | 64            | 6                | 1.8     |
| 110                           | 1,000         | 10               | 3.0     |
| 113                           | 10,000        | 13               | 4.0     |
| 120                           | 1,000,000     | 20               | 6.0     |

**ND Filter 101:** The lightest ND filter, it attenuates light by one f-stop (log density 0.3), which can be beneficial, for instance, for the correct exposure of high-speed films when the brightness of the subject is still too high for the fastest shutter speed and the smallest aperture. Ideal as a complement to the ND 102 for fine adjustments. The filter factor is 2x.

**ND Filter 102:** The most popular ND filter, the ND 102 reduces light by two f-stops (log density 0.6) and offers many benefits, for instance f/4 instead of f/8 for selective sharpness instead of a great depth of field, or 1/15 sec. instead of 1/60 sec. for a flowing instead of a "frozen" waterfall. It has excellent color neutrality, costs less than the denser filters, and is recommended as part of a basic outfit. The filter factor is 4x.

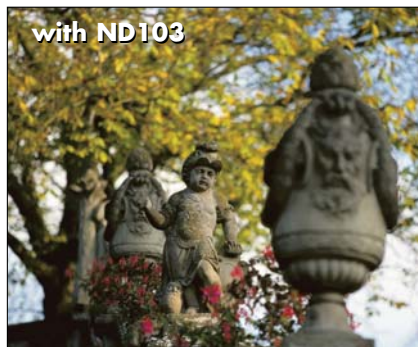

**ND Filter 103:** Somewhat more difficult to manufacture and thus a little more expensive, the ND 103 reduces light intensity by three f-stops (log density 0.9). It still features very good color neutrality. Ideal for use on video cameras when the lens cannot be stopped down sufficiently in great brightness or when a deliberately low depth of field is desired. The filter factor is 8x.

## NEUTRAL DENSITY FILTERS

**ND Filter 106:** The ND 106 reduces light by six f-stops. That means without changing the f-stop, a shutter speed of 1/60 sec. is changed to a full second, thus requiring the use of a tripod. Flowing water is rendered as flowing in the photo, and people moving in streets are dissolved in unsharpness. Because of its higher transmission in the red beyond 660 nm, brings a slightly warm tone to color photographs. (If this effect is undesirable, a B+W UV-/IR-Blocking Filter 486 in front of the ND filter remedies that situation). The filter factor is 64x.

**ND Filter 110:** With a light intensity reduction of ten f-stops, the ND 110 has a slightly stronger warm tone than the ND 106. Its principal field of application is the observation and documentation of industrial processes with extreme brightness, such as steel furnaces, incinerators, glowing filaments in halogen- and other bulbs. The filter factor is 1000x.



**ND Filter 113:** With its light reducing capability of 13 f-stops, the ND 113 is used in astronomy for photographs of the sun and the relative movements of heavenly bodies as light traces in extremely long exposure times. Not be used for observation of the sun (danger of blindness!) due to its greater transmission in the infrared range. Filter factor is 10,000x.

**ND Filter 120:** With light reduction capability of 20 f-stops, the ND 120 is used for the same astro-photographic applications as the ND 113 when an even greater light attenuation is required. In spite of its much higher density, this filter too, must not be used for visual observation because of its transmission in the infrared range. The filter factor is 1,000,000x.

### NEUTRAL DENSITY FILTERS

| Filter Size (mm)    |            | 30.5  | 35.5  | 37    | 39    | 40.5  | 43    | 46    | 48    | 49    | 52    | 55    |
|---------------------|------------|-------|-------|-------|-------|-------|-------|-------|-------|-------|-------|-------|
| ND 101 or 102       | #BW()()    | 24.95 | 24.95 | 24.95 | 24.95 | 24.95 | 24.95 | 24.95 | 24.95 | 19.95 | 19.95 | 22.95 |
| ND 101 or 102-W/A   | #BW()()EW  | —     | —     | —     | —     | —     | —     | —     | —     | 49.95 | 49.95 | 56.95 |
| ND 101 or 102-SLIM  | #BW()S()   | —     | —     | —     | —     | —     | —     | —     | —     | 44.95 | 44.95 | 49.95 |
| ND 101 or 102 MRC   | #BW()MC()  | 39.95 | 39.95 | 39.95 | 39.95 | 39.95 | 39.95 | 39.95 | 39.95 | 29.95 | 29.95 | 32.95 |
| ND 101/102 MRC-SLIM | #BW()MCS() | —     | —     | —     | —     | —     | —     | —     | —     | 52.95 | 52.95 | 69.95 |
|                     |            |       |       |       |       |       |       |       |       |       |       |       |
| ND 103              | #BW103()   | 46.95 | 46.25 | 46.95 | 46.25 | 46.25 | 46.25 | 46.95 | 46.95 | 35.95 | 36.95 | 43.95 |
| ND 103-W/A          | #BW103()EW | —     | —     | —     | —     | —     | —     | —     | —     | 82.95 | 82.95 | 92.95 |
| ND 103-SLIM         | #BW103S()  | —     | —     | —     | —     | —     | —     | —     | —     | 64.95 | 64.95 | 74.95 |
|                     |            |       |       |       |       |       |       |       |       |       |       |       |
| ND 106 or 110       | #BW()()    | 46.95 | 46.95 | 46.95 | 46.25 | 46.95 | 46.95 | 46.95 | 46.95 | 35.95 | 36.95 | 43.95 |
| ND 106 or 110-W/A   | #BW()()EW  | —     | —     | —     | —     | —     | —     | —     | —     | 82.95 | 82.95 | 92.95 |
| ND 106 or 110-SLIM  | #BW()S()   | —     | —     | —     | —     | —     | —     | —     | —     | 64.95 | 64.95 | 74.95 |
|                     |            |       |       |       |       |       |       |       |       |       |       |       |
| ND 113 or 120       | #BW()()    | 46.95 | 46.95 | 46.95 | 46.25 | 46.95 | 46.95 | 46.95 | 46.95 | 35.95 | 36.95 | 43.95 |
| ND 113 or 120-W/A   | #BW()()EW  | —     | —     | —     | —     | —     | —     | —     | —     | 82.95 | 82.95 | 92.95 |
| ND 113 or 120-SLIM  | #BW()S()   | —     | —     | —     | —     | —     | —     | —     | —     | 64.95 | 64.95 | 74.95 |

*In the parenthesis insert the ND number and then the filter size. For example, a 67mm ND 113-SLIM would be BW113S67.*

*Series 5.5, Series 6, Series 8 and Series 9 are also available special order.*

## NEUTRAL DENSITY FILTERS

| NEUTRAL DENSITY FILTERS |                |        |        |        |        |        |        |        |        |        |        |        |
|-------------------------|----------------|--------|--------|--------|--------|--------|--------|--------|--------|--------|--------|--------|
| Filter Size (mm)        |                | 58     | 60     | 62     | 67     | 72     | 77     | 82     | 86     | 95     | 105    | 112    |
| ND 101 or 102           | #BW()( )       | 24.95  | 39.95  | 27.95  | 36.95  | 46.95  | 52.95  | 72.95  | 79.95  | 109.95 | 134.95 | 174.95 |
| ND 101 or 102-W/A       | #BW()( )EW     | 67.95  | —      | 76.95  | 79.95  | 92.95  | 94.95  | 112.95 | 119.95 | 137.95 | 169.95 | —      |
| ND 101 or 102-SLIM      | #BW()( )S( )   | 64.95  | 82.95  | 69.95  | 69.95  | 79.95  | 84.95  | 97.95  | 106.95 | 142.95 | 164.95 | —      |
| ND 101 or 102 MRC       | #BW()( )MC( )  | 34.95  | 59.95  | 42.95  | 49.95  | 62.95  | 79.95  | 104.95 | 109.95 | 154.95 | 179.95 | —      |
| ND 101/102 MRC-SLIM     | #BW()( )MCS( ) | 79.95  | 99.95  | 89.95  | 96.95  | 107.95 | 112.95 | 124.95 | 142.95 | 159.95 | 192.95 | —      |
| ND 103                  | #BW103( )      | 45.95  | 74.95  | 72.95  | 74.95  | 94.95  | 104.95 | —      | —      | —      | —      | —      |
| ND 103-W/A              | #BW103( )EW    | 109.95 | —      | 124.95 | 128.50 | —      | —      | —      | —      | —      | —      | —      |
| ND 103-SLIM             | #BW103S( )     | 94.95  | 134.95 | 102.95 | 106.95 | 129.95 | 137.95 | —      | —      | —      | —      | —      |
| ND 106 or 110           | #BW()( )       | 45.95  | 74.95  | 72.95  | 44.95  | 94.95  | 104.95 | —      | —      | —      | —      | —      |
| ND 106 or 110-W/A       | #BW()( )EW     | 109.95 | —      | 124.95 | 128.95 | —      | —      | —      | —      | —      | —      | —      |
| ND 106 or 110-SLIM      | #BW()( )S( )   | 74.95  | 134.95 | 102.95 | 106.95 | 129.95 | 137.95 | —      | —      | —      | —      | —      |
| ND 113 or 120           | #BW()( )       | 45.95  | 74.95  | 72.95  | 74.95  | 94.95  | 104.95 | 119.95 | —      | —      | —      | —      |
| ND 113 or 120-W/A       | #BW()( )EW     | 109.95 | —      | 124.95 | 128.95 | —      | —      | —      | —      | —      | —      | —      |
| ND 113 or 120-SLIM      | #BW()( )S( )   | 94.95  | 134.95 | 102.95 | 106.95 | 129.95 | 137.95 | —      | —      | —      | —      | —      |

| NEUTRAL DENSITY FILTERS |                |        |       |       |       |        |        |        |        |         |          |           |
|-------------------------|----------------|--------|-------|-------|-------|--------|--------|--------|--------|---------|----------|-----------|
| Filter Size (mm)        |                | 122    | Bay 1 | Bay 2 | Bay 3 | Bay 6  | Bay 50 | Bay 60 | Bay 70 | Bay 104 | Series 7 | Series 93 |
| ND 101 or 102           | #BW()( )       | 179.95 | 32.95 | 37.95 | 42.95 | 154.95 | —      | 132.95 | 149.95 | 207.95  | 27.95    | 84.95     |
| ND 101 or 102-W/A       | #BW()( )EW     | —      | —     | —     | —     | —      | —      | —      | —      | —       | —        | —         |
| ND 101 or 102-SLIM      | #BW()( )S( )   | —      | —     | —     | —     | —      | —      | —      | —      | —       | —        | —         |
| ND 101 or 102 MRC       | #BW()( )MC( )  | —      | 42.95 | 49.95 | 56.95 | 194.95 | —      | 144.95 | 174.95 | 254.95  | 42.95    | 119.95    |
| ND 101/102 MRC-SLIM     | #BW()( )MCS( ) | —      | —     | —     | —     | —      | —      | —      | —      | —       | —        | —         |
| ND 103                  | #BW103( )      | —      | 52.95 | 62.95 | 69.95 | 264.95 | —      | 154.95 | 179.95 | —       | 44.95    | 199.95    |
| ND 103-W/A              | #BW103( )EW    | —      | —     | —     | —     | —      | —      | —      | —      | —       | —        | —         |
| ND 103-SLIM             | #BW103S( )     | —      | —     | —     | —     | —      | —      | —      | —      | —       | —        | —         |
| ND 106 or 110           | #BW()( )       | —      | 52.95 | 62.95 | 69.95 | 264.95 | —      | 154.95 | 179.95 | —       | 44.95    | —         |
| ND 106 or 110-W/A       | #BW()( )EW     | —      | —     | —     | —     | —      | —      | —      | —      | —       | —        | —         |
| ND 106 or 110-SLIM      | #BW()( )S( )   | —      | —     | —     | —     | —      | —      | —      | —      | —       | —        | —         |
| ND 113 or 120           | #BW()( )       | —      | 52.95 | 62.95 | 69.95 | 264.95 | —      | 154.95 | 179.95 | —       | 44.95    | —         |
| ND 113 or 120-W/A       | #BW()( )EW     | —      | —     | —     | —     | —      | —      | —      | —      | —       | —        | —         |
| ND 113 or 120-SLIM      | #BW()( )S( )   | —      | —     | —     | —     | —      | —      | —      | —      | —       | —        | —         |

1. In the parenthesis insert the filter size. For example, a 122mm ND 101 MRC would be BW101MC122.
2. For Bay sizes insert just the letter B and the number. For example, 122mm ND 101 MRC in Bay 60 is BW101MCB60.
3. For Series 7 and 93, insert just the letter S and the number. For example, 122mm ND 101 MRC in Series 93 is BW101MCS93.
4. Series 5.5, Series 6, Series 8 and Series 9 are also available special order.





## POLARIZING FILTERS

With B+W polarizing filters, reflections on glass, plastic and lacquer surfaces can be reduced or even eliminated. B+W polarizing filters give you the control over how much reflection you wish to remain because the light reflected at an angle of about 40° to 70° by these surfaces is strongly polarized. Its transmission can be reduced, blocked or even enhanced in relation to the remaining unpolarized light, depending on the rotation of the filter. Thus a clear view is made possible through plates of glass, of goldfish below the surface of the water, or of writing or pictures behind a glossy layer of lacquer.

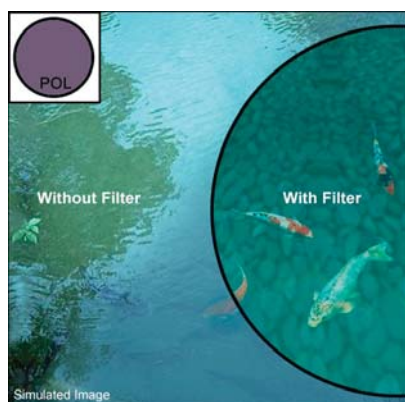

Every object outdoors reflects light from the sky more or less diffusely and largely polarized, some objects, such as green plants and red roof tiles are covered by a bluish-gray veil that can make them appear pale and dirty. B+W polarizing filters remove this polarized veil thus increasing the saturation of the true color. Bring out deep, rich greens in foliage and reduce the objectionable effect of smog in a photograph of a cityscape horizon. Because the blue light from the sky, especially at an angle approximately perpendicular to the sun is strongly polarized, a polarizer can be used to render the sky with a more saturated color, so that white clouds will stand out more dramatically. Using a polarizer for black-and-white film, reflections can be accentuated or reduced, and can have higher image contrast. The effect of B+W polarizers can be observed through the viewfinder while rotating the front element of the polarizer.

Linear and circular polarizers both consist of a linear polarizer foil but differ in their construction. Today's SLR cameras have a beam-splitting prism that sends part of the incoming light to the meter and part to the viewfinder. The effect is that the light entering the meter is partially polarized by the beam-splitter. A linear polarizer placed on the lens of such a system will act as a second polarizer and block light to the meter by a degree dependent on the angle between the prism and the polarizer on the lens. The result is incorrect exposure/aperture values from the meter. The circular polarizer circumvents this problem through the addition of a 1/4-wave retarder, or delay, foil. This ensures that the linearly polarized light is changed into a rotation that appears unpolarized to the meter, resulting in proper exposure/aperture readings.

### The B&W Difference

Unlike some other polarizing filters, B+W Polarizing Filters do not consist of a plastic polarizing foil loosely sandwiched between two protective glass discs. Instead, the polarizing foil is cemented to both glass discs for much better optical quality. Even the tiniest surface irregularities on plastic polarizing foils, which can not be produced as smoothly and as evenly as polished glass, are evened out by this process. The number of reflective glass-to-air or foil-to-air surfaces is reduced from six to only two. B+W Polarizing Filters are distinguished by their higher light transmission, brilliance, and yield excellent detail even in the shadow areas. This preserves the full image-quality of the lens.

### Versatile Tools

Polarizers are commonly used to control glare on water and to allow the camera to see below the surface. They are also used to reduce glare on car bumpers and to control reflections on plate-glass windows. Polarizers are so versatile that they can perform the opposite functions as well. Some use polarizers to increase or enhance reflections, simply by changing the filter's setting.

- ◆ Darkening skies in color photography for dramatic impact. While graduated neutral density filters can also be used to achieve this effect, the need to position their transition line accurately precludes their use in many applications. Polarizers do not suffer from this limitation.
- ◆ Suppressing reflections and capturing truer color when shooting subjects through a windshield, and from other rigged-car camera positions.
- ◆ Greatly adding to the drama and appeal of the shot when photographing food (particularly meat or liquids).
- ◆ Increasing the color saturation of any object with a glossy surface.
- ◆ In fact, virtually any subject involving glare or reflections, or that is illuminated with specular light, can be improved through the skillful use of a quality polarizing filter.



## POLARIZING FILTERS

### Top-Pol (Linear) Polarizer

Linear polarization filter for SLRs and rangefinder cameras without beam splitters in their light paths. High-quality optical glass ensures excellent pictorial quality. B+W Top-Pol Polarizing Filters are available uncoated and with B+W's proprietary MRC coating.

### Circular Polarizer

Highly efficient standard circular polarizing filter for all cameras with beam splitters in the light paths of their TTL exposure meter and with autofocus lenses. Circular polarization has the same pictorial effect as linear polarization, but allows for proper exposure metering and/or autofocus distance settings.

### Warm Tone Polarizer

These filters are special versions of the B+W Linear- and Circular Polarizing Filters with an KR 1.5 correction filter or an 81A warm tone filter as protection glass (KR 3 or 81B on request). This combines the optical qualities of both filters in a single filter.

### B+W Redhancer 491

Designed to strengthen the reddish components of orange, near red or brown subjects, the B+W Redhancer is popular for use in nature- and landscape photography. It is particularly effective in conjunction with a polarizing filter, controlling a potentially bluish-gray veil and for increasing color saturation, e.g. to capture fabulously vivid scenery during the colorful autumn season. The use of color reversal film is recommended, because the automatic correction applied by printers to color negatives can erroneously interpret the desired effect as a color cast and reduce it by filtering it out.



### 'Käsemann' Polarizer

The "high-end" polarizing foils of the Käsemann-type filters are neutral in color, have a higher efficiency than conventional polarizing foils and they are cemented between high-grade plano-parallel optical glass. The resulting sandwich is then precision-polished again to achieve highly accurate plano-parallel surfaces. Subsequently they are edge-sealed to protect the foil against humidity. Brass mounts made on CNC-controlled machines ensure precise seating on the lens. Discriminating photographers regard the B+W Käsemann-Type to be the best of all polarizing filters. They are well suited for applications that require the highest possible imaging quality, especially with high-speed telephoto lenses and apochromatic lenses. They are available as linear and circular polarizing filters, and also with SLIM- or oversized wide-angle mounts.

### POLARIZERS

| Filter Size (mm)                   | 30.5  | 35.5  | 37    | 39    | 40.5  | 43    | 46    | 48     | 49    | 52     | 55     |
|------------------------------------|-------|-------|-------|-------|-------|-------|-------|--------|-------|--------|--------|
| Top-Polarizer #BWP()               | —     | —     | —     | —     | 44.95 | 44.95 | 44.95 | 44.95  | 34.95 | 37.95  | 42.95  |
| Top-Polarizer MRC #BWP(MC)         | —     | —     | —     | —     | —     | —     | —     | —      | 52.95 | 53.95  | 59.95  |
| Circular Polarizer #BWCP()         | 79.95 | 79.95 | 79.95 | 79.95 | 79.95 | 79.95 | 79.95 | 79.95  | 58.95 | 67.95  | 69.95  |
| Circular Polarizer SLIM #BWCP(S)   | —     | —     | —     | —     | —     | —     | —     | —      | 54.95 | 54.95  | 64.95  |
| Circular Polarizer MRC #BWCP(MC)   | —     | —     | —     | —     | —     | —     | —     | —      | 79.95 | 79.95  | 89.95  |
| Circ. Pola. MRC-SLIM #BWCP(MC(S))  | —     | —     | —     | —     | —     | —     | —     | —      | 72.95 | 79.95  | 89.95  |
| Kasemann Polarizer #BWKP()         | 79.95 | 79.95 | 79.95 | 79.95 | 79.95 | 79.95 | 79.95 | 79.95  | 72.95 | 76.95  | 87.95  |
| Kasemann Pola-WA #BWKP()EW         | —     | —     | —     | —     | —     | —     | —     | —      | —     | —      | —      |
| Kasemann Circ. Pola #BWKP()        | 89.95 | 89.95 | 89.95 | 89.95 | 89.95 | 89.95 | 89.95 | 89.95  | 89.95 | 94.95  | 102.95 |
| Kas. Circ. Pola-MRC-SLIM #BWKCP(S) | —     | —     | —     | —     | —     | —     | —     | —      | 89.95 | 94.95  | 104.95 |
| Kas. Circ. Pola-MRC WA #BWKCP()EW  | —     | —     | —     | —     | —     | —     | —     | —      | —     | —      | —      |
| Warm Polarizer 81A #BWWP81A()      | —     | —     | —     | —     | —     | —     | 92.95 | 94.95  | 79.95 | 102.95 | 114.00 |
| Warm Polarizer KR1.5 #BWWP()       | —     | —     | —     | —     | —     | —     | —     | —      | —     | —      | —      |
| Warm Circular Pola #BWWCP81A()     | —     | —     | —     | —     | —     | —     | 99.95 | 104.95 | 92.95 | 125.95 | 127.95 |
| Warm Circular Pola KR1.5 #BWWCP()  | —     | —     | —     | —     | —     | —     | 99.95 | 104.95 | 92.95 | 125.95 | 127.95 |
| Redhancer 491 #BWE()               | —     | —     | —     | —     | —     | —     | —     | 46.95  | 35.95 | 36.95  | 43.95  |

In the parenthesis insert the filter size. For example, a 37mm Circular Polarizer would be BWCP37.



## POLARIZING FILTERS

### POLARIZERS

| Filter Size (mm)                   | 58     | 60     | 62     | 67     | 72     | 77     | 82     | 86     | 95     | 105    | 112    |
|------------------------------------|--------|--------|--------|--------|--------|--------|--------|--------|--------|--------|--------|
| Top-Polarizer #BWP()               | 44.95  | —      | 49.95  | 54.95  | 62.95  | 72.95  | 97.95  | 124.95 | 154.95 | 179.95 | —      |
| Top-Polarizer MRC #BWPMC()         | 62.95  | —      | 62.95  | 72.95  | 79.95  | 89.95  | —      | —      | —      | —      | —      |
| Circular Polarizer #BWCP()         | 74.95  | 99.95  | 79.95  | 89.95  | 102.95 | 114.95 | —      | —      | —      | —      | —      |
| Circular Polarizer SLIM #BWCPS()   | 72.95  | —      | 79.95  | 89.95  | 99.95  | 109.95 | 124.95 | —      | —      | —      | —      |
| Circular Polarizer MRC #BWCPMC()   | 94.95  | 119.95 | 98.95  | 114.95 | 129.95 | 144.95 | —      | —      | —      | —      | —      |
| Circ. Pola. MRC-SLIM #BWCPMCS()    | 99.95  | —      | 109.95 | 129.95 | 154.95 | 164.95 | 199.95 | —      | —      | —      | —      |
| Kasemann Polarizer #BWKP()         | 94.95  | —      | 99.95  | 109.95 | 124.95 | 149.95 | 169.95 | 179.95 | 199.95 | 229.95 | 339.95 |
| Kasemann Pola-WA #BWKP()EW         | —      | —      | 179.95 | 179.95 | 209.95 | 239.95 | 269.95 | 289.95 | 309.95 | 349.95 | —      |
| Kasemann Circ. Pola-MRC #BWKCP()   | 104.95 | 129.95 | 114.95 | 129.95 | 144.95 | 164.95 | 194.95 | 214.95 | 234.95 | 264.95 | 379.95 |
| Kas. Circ. Pola-MRC Slim #BWKCP()S | 109.95 | —      | 114.95 | 139.95 | 154.95 | 174.95 | —      | —      | —      | —      | —      |
| Kas. Circ. Pola-MRC WA #BWKCP()EWS | —      | —      | 199.95 | 199.95 | 229.95 | 259.95 | 299.95 | 319.95 | 339.95 | 389.95 | —      |
| Warm Polarizer 81A #BWWP81A()      | 117.95 | 129.95 | 124.95 | 142.95 | 152.95 | 182.95 | 214.95 | —      | 234.95 | —      | —      |
| Warm Circular Pola #BWWCP81A()     | 137.95 | 154.95 | 138.95 | 164.95 | 179.95 | 199.95 | —      | —      | —      | —      | —      |
| Warm Circular Pola KR1.5 #BWWP()S  | 137.95 | 154.95 | 138.95 | 164.95 | 179.95 | 199.95 | 244.95 | 234.95 | 259.95 | 289.95 | —      |
| Redhancer 491 #BWE()               | 45.95  | —      | 72.95  | 74.95  | 94.95  | 104.95 | —      | —      | —      | —      | —      |

1. In the parenthesis insert the filter size. For example, an 82mm Redhancer 491 would be BWE82.

2. For Bay sizes insert just the letter B and the number. For example, a Circular Polarizer in Bay 104 is BWCPB104.

3. For Series 7 and 93, insert just the letter S and the number. For example, a Circular Polarizer in Series 93 is BWCPS93.

4. Series 5.5, Series 6, Series 8 and Series 9 are also available special order.

### POLARIZERS

| Filter Size (mm)                   | 122    | Bay 1  | Bay 2  | Bay 3  | Bay 6  | Bay 50 | Bay 60 | Bay 70 | Bay 104 | Series 7 | Series 93 |
|------------------------------------|--------|--------|--------|--------|--------|--------|--------|--------|---------|----------|-----------|
| Top-Polarizer #BWP()               | —      | —      | —      | —      | —      | —      | —      | —      | —       | —        | —         |
| Top-Polarizer MRC #BWPMC()         | —      | —      | —      | —      | —      | —      | —      | —      | —       | —        | —         |
| Circular Polarizer #BWCP()         | —      | —      | —      | —      | —      | —      | —      | —      | —       | —        | —         |
| Circular Polarizer SLIM #BWCPS()   | —      | —      | —      | —      | —      | —      | —      | —      | —       | —        | —         |
| Circular Polarizer MRC #BWCPMC()   | —      | —      | —      | —      | —      | —      | —      | —      | —       | —        | —         |
| Circ. Pola. MRC-SLIM #BWCPMCS()    | —      | —      | —      | —      | —      | —      | —      | —      | —       | —        | —         |
| Kasemann Polarizer #BWKP()         | 49.95  | 92.95  | 94.95  | 104.95 | 274.95 | —      | 254.95 | 279.95 | 15.50   | 74.95    | 344.95    |
| Kasemann Pola-WA #BWKP()EW         | —      | —      | —      | —      | —      | —      | —      | —      | —       | —        | —         |
| Kasemann Circ. Pola #BWKCP()       | 524.95 | 109.95 | 119.95 | 134.95 | 344.95 | 37.50  | 279.95 | 299.95 | —       | 96.95    | 369.95    |
| Kas. Circ. Pola-MRC Slim #BWKCP()S | —      | —      | —      | —      | —      | —      | —      | —      | —       | —        | —         |
| Kas. Circ. Pola-MRC WA #BWKCP()EWS | —      | —      | —      | —      | —      | —      | —      | —      | —       | —        | —         |
| Warm Polarizer 81A #BWWP81A()      | —      | —      | —      | —      | —      | —      | —      | —      | —       | —        | —         |
| Warm Circular Pola #BWWCP81A()     | —      | —      | —      | —      | —      | —      | —      | —      | —       | —        | —         |
| Redhancer 491 #BWE()               | —      | —      | —      | —      | —      | —      | —      | —      | —       | —        | —         |

## LIGHT BALANCING (CONVERSION) FILTERS

### Cooling Filters

*Illumination with a high percentage of red, as in light from a photoflood lamp, leads to a complete distortion of the original composition when used with daylight color film. Despite the handicaps of inadvertently selecting the wrong film and inappropriate lighting, color conversion (cooling) filters, such as the blue-violet KB-20, make more natural looking results possible.*

**KB 1.5 (82A):** The conversion filter with the most delicate shade of blue attenuates the slightly higher red, orange and yellow components in order to produce a neutral color rendition. It can also be used for subjects that are to be shown with a cooler coloring. In addition, it adapts the color temperature of the very bright photoflood lamps to color films balanced for halogen light of 3200 K. Filter factor is approximately 1.1.

**KB 3 (82C):** With about twice the correcting effect of the KB 1.5 filter, this filter removes the orange-red color cast that appears on photographs made on tungsten reversal film with artificial light using 100 to 200w light bulbs, or from aged photoflood lamps. Therefore this filter is ideal for neutral color reproduction with appropriate illumination. Filter factor is approximately 1.2.

**KB 6 (80D):** This nearly medium blue conversion filter neutralizes the strong red tendency of light at sunrise or sunset out in the open when the original colors of the subject are wanted instead of a warm morning- or evening mood. In addition, the KB 6 filter is ideal for “under-corrected” filtering of artificial light photographs on color negative films. When filtration is performed only later during printing, there is a visible color shift, and full correction leads to a higher loss of light. Its filter factor is approximately 1.5.

| Filter Type | Color Temperature Corrected From |
|-------------|----------------------------------|
| KB 1.5      | 3000 K to 3200 K                 |
| KB 3        | 2800 K to 3200 K                 |
| KB 6        | 4100 K to 5500 K                 |
| KB 12       | 3400 K to 5500 K                 |
| KB 15       | 3200 K to 5500 K                 |
| KB 20       | 2600 K to 5500 K                 |

**KB 12 (80B):** The deep blue KB 12 blocks so much red, orange and yellow that it increases the color temperature of very bright halogen and special photoflood lamps (around 3400 K) to that of daylight. With that kind of illumination, and with daylight color reversal film, subjects will be reproduced in their original colors. With weaker halogen bulbs or stronger incandescent bulbs in conjunction with this filter and with daylight reversal film, a residue of “warmth” is retained for an optimal mood in interior photographs. Filter factor is 2.0.

**KB 15 (80A):** The slightly denser KB 15 filter is recommended for daylight color reversal film with artificial light from the 60 to 100w halogen bulbs commonly used in lights aimed at the ceiling. With weaker incandescent bulbs, there will again be that pleasant warm tone for moody interior photographs. Its filter factor is approximately 2.2.

**KB 20:** Used when the illumination provided by 40 to 150w household incandescent bulbs, and the transparencies are to show the subject in its original colors (e.g., technical interior, architectural photographs, or reproductions). However, it shouldn't be used for moody interior pictures because unlike the KB 12 and KB 15, the KB 20 filter corrects the light to a neutral balance, eliminating the warmth that one might intuitively expect from bulbs. Filter factor is 2.7.



## LIGHT BALANCING (CONVERSION) FILTERS

### KB1.5/KB3/KB6/KB12/KB15/KB20 COOLING FILTERS

| Filter Size (mm)        | 30.5  | 35.5  | 37    | 39    | 40.5  | 43    | 46    | 48    | 49    | 52    | 55    |
|-------------------------|-------|-------|-------|-------|-------|-------|-------|-------|-------|-------|-------|
| Standard #BW()()        | 24.95 | 24.95 | 24.95 | 24.95 | 24.95 | 24.95 | 24.95 | 24.95 | 19.95 | 19.95 | 22.95 |
| Standard-SLIM #BW()S()  | —     | —     | —     | —     | —     | —     | —     | —     | 44.95 | 44.95 | 49.95 |
| Standard- W/A #BW()()EW | —     | —     | —     | —     | —     | —     | —     | —     | 49.95 | 49.95 | 56.95 |
| MRC #BW()MC()           | —     | —     | 39.95 | 39.95 | —     | 39.95 | 39.95 | 39.95 | 29.95 | 29.95 | 32.95 |
| MRC-SLIM #BW()MCS()     | —     | —     | —     | —     | —     | —     | —     | —     | 52.95 | 52.95 | 69.95 |
| MRC-W/A #BW()MC()EW     | —     | —     | —     | —     | —     | —     | —     | —     | 59.95 | 59.95 | 77.95 |

### KB1.5/KB3/KB6/KB12/KB15/KB20 COOLING FILTERS

| Filter Size (mm)        | 58    | 60    | 62    | 67     | 72     | 77     | 82     | 86     | 95     | 105    | 112    |
|-------------------------|-------|-------|-------|--------|--------|--------|--------|--------|--------|--------|--------|
| Standard #BW()()        | 24.95 | 39.95 | 29.95 | 36.95  | 46.95  | 52.95  | 72.95  | 79.95  | 109.95 | 134.95 | 174.95 |
| Standard-SLIM #BW()S()  | 64.95 | 82.95 | 69.95 | 69.95  | 83.75  | 79.95  | 97.95  | 106.95 | 142.95 | 164.95 | —      |
| Standard- W/A #BW()()EW | 67.95 | —     | 75.95 | 79.95  | 92.95  | 94.95  | 112.95 | 119.95 | 139.95 | 169.95 | —      |
| MRC #BW()MC()           | 34.95 | 59.95 | 42.95 | 49.95  | 62.95  | 79.95  | 104.95 | 109.95 | 154.95 | 179.95 | —      |
| MRC-SLIM #BW()MCS()     | 79.95 | 99.95 | 89.95 | 96.95  | 107.95 | 112.00 | 124.95 | 142.95 | 159.95 | 192.95 | —      |
| MRC-W/A #BW()MC()EW     | 89.95 | —     | 99.95 | 109.95 | 124.95 | 124.95 | 144.95 | 159.95 | 179.95 | 219.95 | —      |

### KB1.5/KB3/KB6/KB12/KB15/KB20 COOLING FILTERS

| Filter Size (mm)        | 122    | Bay 1 | Bay 2 | Bay 3 | Bay 6  | Bay 50 | Bay 60 | Bay 70 | Bay 104 | Series 7 | Series 93 |
|-------------------------|--------|-------|-------|-------|--------|--------|--------|--------|---------|----------|-----------|
| Standard #BW()()        | 179.95 | 32.95 | 37.95 | 42.95 | 154.95 | —      | 132.95 | 149.95 | 105.95  | 279.95   | 84.95     |
| Standard-SLIM #BW()S()  | —      | —     | —     | —     | —      | —      | —      | —      | —       | —        | —         |
| Standard- W/A #BW()()EW | —      | —     | —     | —     | —      | —      | —      | —      | —       | —        | —         |
| MRC #BW()MC()           | —      | 42.95 | 49.95 | 56.95 | 194.95 | —      | 144.95 | 174.95 | —       | 42.95    | 119.95    |
| MRC-SLIM #BW()MCS()     | —      | —     | —     | —     | —      | —      | —      | —      | —       | —        | —         |
| MRC-W/A #BW()MC()EW     | —      | —     | —     | —     | —      | —      | —      | —      | —       | —        | —         |

1. In the first parenthesis insert the filter type. In the second parenthesis insert the filter size.

For example, a 58mm KB-6 Standard Wide Angle filter would be BWKB658EW.

2. For Bay sizes insert just the letter B and the number. For example, a KB-3 Bay 60 would be BWKB3B60.

3. For Series 7 and 93, insert just the letter S and the number. For example, a KB-6 Standard in Series 7 is BWKB6S7.

4. Series 5.5, Series 6, Series 8 and Series 9 are also available special order.



## LIGHT BALANCING (CONVERSION) FILTERS

### Warming Filters

Color conversion filters balance the spectral composition of the photographic light source to the color temperature balance of photographic films. This color temperature is expressed in degrees Kelvin ('K'). High color temperature light becomes blue while low tends to have a reddish tone. Depending upon the degree of necessary color temperature conversion, reddish to brown or blue-toned, color conversion filters in varying density are required to absorb the predominant color tones of the light. Refer to the color temperature tables to see which filters are necessary.

| Filter Type | Color Temperature Corrected From |
|-------------|----------------------------------|
| KR 1.5      | 3400 K to 3200 K                 |
| KR 3        | 3600 K to 3200 K                 |
| KR 6        | 3900 K to 3200 K                 |
| KR 12       | 5500 K to 3400 K                 |
| 81A         | 3400 K to 3200 K                 |
| 81B         | 3500 K to 3200 K                 |



Atmospheric haze causes blue cast

Color Correction with KR 1.5

Warm autumn vegetation with KR 6



Blue cast on walls in the shade

81A filter neutralizes the blue cast

Rendition of neutral colors with KR 3

**KR 1.5 (1A):** This filter also blocks UV radiation and reduces haze in the scene. However, due to its light pink color, the KR 1.5 reduces the high blue cast in the shadow portions of color photographs caused by light coming from a blue sky. Because of its very faint color, a skylight filter can be kept on a lens constantly for protection, as long as a slightly warmer color rendition is desired, as it would be with color reversal films that tend to produce cooler colors. The exposure factor is only 1.1 so for practical purposes it can be ignored.

**KR 3 (81C):** This filter is recommended for daylight photographs, especially in spring and summer with cloudless skies and clear air. It helps eliminate the strong blue tone and haziness which is produced by this level of ultraviolet light. Furthermore, it reduces the unwanted blue tone in shadow areas with an overcast sky. Filter factor is approx. 1.2.

**KR 6 (81EF):** Daylight with a high percentage of blue (midday in the mountains during the summer) is neutralized by the KR 6 in color photos where an extreme blue tone is to be expected. Not only does it block ultraviolet light and reduce blue tones in the shade, but it also penetrates light fog. Filter factor is approx. 1.4.

**KR 12 (85EF):** When using the brown toned KR 12 with tungsten-balanced color film, one can photograph in daylight or with flash illumination. This eliminates the strong overall bluish cast which would be present otherwise. In addition, many color films respond to this color conversion filter with particularly brilliant color tones. Filter factor is approx. 2.0.

**B+W 81A:** This filter balances color temperature from artificial light sources to the color tungsten film standard of 3200 degrees and balances the difference up to 3400 degrees. Due to this characteristic, a noticeable warmer color reproduction is produced. This fine balancing is important for special work such as art reproductions where true color reproduction is required. Filter factor is approx. 1.2.

**B+W 81B:** The 81B makes possible a stronger color temperature balance from artificial light sources to 3500 degrees which also results in a slightly warmer color reproduction. In addition, when using artificial light for portraits, especially when more flattering warmer colors are appropriate (portraits of women and children), this filter is highly recommended. Filter factor is approx. 1.2.

## LIGHT BALANCING (CONVERSION) FILTERS

### KR1.5/KR3/KR6/KR12/81A/81B WARMING FILTERS

| Filter Size (mm)        | 30.5  | 35.5  | 37    | 39    | 40.5  | 43    | 46    | 48    | 49    | 52    | 55    |
|-------------------------|-------|-------|-------|-------|-------|-------|-------|-------|-------|-------|-------|
| Skylight KR1.5 #BWSL()  | 24.95 | 24.95 | 24.95 | 24.95 | 24.95 | 24.95 | 24.95 | 24.95 | 19.95 | 19.95 | 22.95 |
| Standard #BW()()        | 24.95 | 24.95 | 24.95 | 24.95 | 24.95 | 24.95 | 24.95 | 24.95 | 19.95 | 19.95 | 22.95 |
| Standard-SLIM #BW()S()  | —     | —     | —     | —     | —     | —     | —     | —     | 44.95 | 44.95 | 49.95 |
| Standard- W/A #BW()()EW | —     | —     | —     | —     | —     | —     | —     | —     | 49.95 | 49.95 | 56.95 |
| MRC #BW()MC()           | 39.95 | 39.95 | 39.95 | 39.95 | 39.95 | 39.95 | 39.95 | 39.95 | 29.95 | 29.95 | 32.95 |
| MRC-SLIM #BW()MCS()     | —     | —     | —     | —     | —     | —     | —     | —     | 52.95 | 52.95 | 69.95 |
| MRC-W/A #BW()MC()EW     | —     | —     | —     | —     | —     | —     | —     | —     | 59.95 | 59.95 | 77.95 |

### KR1.5/KR3/KR6/KR12/81A/81B WARMING FILTERS

| Filter Size (mm)        | 58    | 60    | 62    | 67     | 72     | 77     | 82     | 86     | 95     | 105    | 112    |
|-------------------------|-------|-------|-------|--------|--------|--------|--------|--------|--------|--------|--------|
| Skylight KR1.5 #BWSL()  | 24.95 | 39.95 | 29.95 | 36.95  | 46.95  | 52.95  | 72.95  | 79.95  | 109.95 | 134.95 | 174.95 |
| Standard #BW()()        | 24.95 | 39.95 | 29.95 | 36.95  | 46.95  | 52.95  | 72.95  | 79.95  | 109.95 | 134.95 | 174.95 |
| Standard-SLIM #BW()S()  | 64.95 | 82.95 | 69.95 | 69.95  | 79.95  | 84.95  | 97.95  | 106.95 | 142.95 | 164.95 | —      |
| Standard- W/A #BW()()EW | 67.95 | —     | 76.95 | 79.95  | 92.95  | 94.95  | 113.95 | 119.95 | 139.95 | 169.95 | —      |
| MRC #BW()MC()           | 34.95 | 59.95 | 47.95 | 49.95  | 62.95  | 79.95  | 104.95 | 109.95 | 154.95 | 179.95 | —      |
| MRC-SLIM #BW()MCS()     | 79.95 | 99.95 | 89.95 | 96.95  | 107.95 | 112.95 | 124.95 | 142.95 | 159.95 | 192.95 | —      |
| MRC-W/A #BW()MC()EW     | 89.95 | —     | 99.95 | 109.95 | 124.95 | 124.95 | 144.95 | 159.95 | 179.95 | 219.95 | —      |

### KR1.5/KR3/KR6/KR12/81A/81B WARMING FILTERS

| Filter Size (mm)        | 122    | Bay 1 | Bay 2 | Bay 3 | Bay 6  | Bay 50 | Bay 60 | Bay 70 | Bay 104 | Series 7 | Series 93 |
|-------------------------|--------|-------|-------|-------|--------|--------|--------|--------|---------|----------|-----------|
| Skylight KR1.5 #BWSL()  | 179.95 | 32.95 | 37.95 | 42.95 | 154.95 | —      | 132.95 | 149.95 | —       | 27.95    | 84.95     |
| Standard #BW()()        | 179.95 | 32.95 | 37.95 | 42.95 | 154.95 | —      | 132.95 | 149.95 | —       | 27.95    | 84.95     |
| Standard-SLIM #BW()S()  | —      | —     | —     | —     | —      | —      | —      | —      | —       | —        | —         |
| Standard- W/A #BW()()EW | —      | —     | —     | —     | —      | —      | —      | —      | —       | —        | —         |
| MRC #BW()MC()           | —      | 42.95 | 49.95 | 56.95 | 194.95 | —      | 144.95 | 174.95 | —       | 42.95    | 119.95    |
| MRC-SLIM #BW()MCS()     | —      | —     | —     | —     | —      | —      | —      | —      | —       | —        | —         |
| MRC-W/A #BW()MC()EW     | —      | —     | —     | —     | —      | —      | —      | —      | —       | —        | —         |

1. In the first parenthesis insert the filter type. In the second parenthesis insert the filter size.

For example, a 58mm KR-6 Standard Wide Angle filter would be BWKR658EW.

2. For Bay sizes insert just the letter B and the number. For example, a KR-3 Bay 60 would be BWKR3B60.

3. For Series 7 and 93, insert just the letter S and the number. For example, a KR-6 Standard in Series 7 is BWKR6S7.

4. Series 5.5, Series 6, Series 8 and Series 9 are also available special order.

## SPECIAL FILTERS

What photographer wouldn't love to leave the beaten path and create pictures that stand out, fascinate, perhaps even take one's breath away? To show objects or landscapes as no eye would see them in nature is an irresistible challenge. A large selection of B+W Special Filters can help you to take on this challenge and master it with perfection. B+W filters that transmit ultraviolet or infrared light, but which block or severely limit the visible spectrum can reveal otherwise hidden worlds, when used in conjunction with appropriately sensitized films. On the other hand, different B+W Special Filters prevent disturbing light and radiation that distorts the pictorial impression from passing through the lens and reaching the film. The FL-Day should be an indispensable accessory for every photographer, because it suppresses the green hue of the light emitted by fluorescent tubes. While inconspicuous to our eyes, it can cause an unpleasant green cast in color photographs.

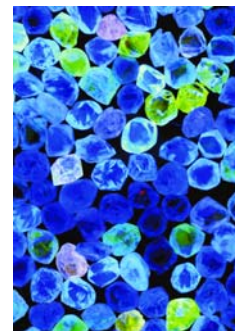

### 499 F-Day (Fluorescent Daylight) Filter:

This filter eliminates the green cast that occurs when daylight-type color film is used under fluorescent lighting. For example, shooting in offices, reception areas, factory halls and subway stations, as well as night-time shots of office buildings whose windows would appear green because their interiors are usually illuminated with fluorescent tubes. The 499 F-Day is designed for the most commonly used type of fluorescent tube, which emit light of a color that, as mentioned above, resembles daylight. Fluorescent tubes are not "thermal radiators"—

they don't produce continuous spectrum like those of the sun and incandescent bulbs. Instead, they emit a sharply defined line spectrum that has high intensity spikes in the green region. Our eyes barely perceive this special green, so the fluorescent light appears to us as nearly neutral in color. However, most color films are especially sensitive to those wavelengths and they react with a strong pronounced cast. Using color temperature meters for three color metering, photographers can undertake the correct filtering with of a combination of Light Balance (LB) and CC filters. With this method, they can also correct the light emitted by other types of fluorescent tubes, such as Warm Tone, Standard Light, White Light, etc. But for those who don't care to carry

along a selection of LB- and CC filters, the F-Day Filter is far less expensive and much more practical. Filter factor is approximately 2.

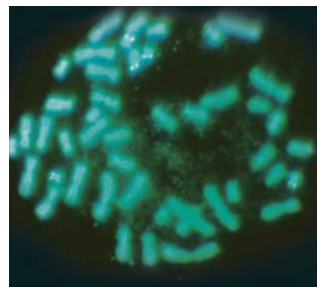
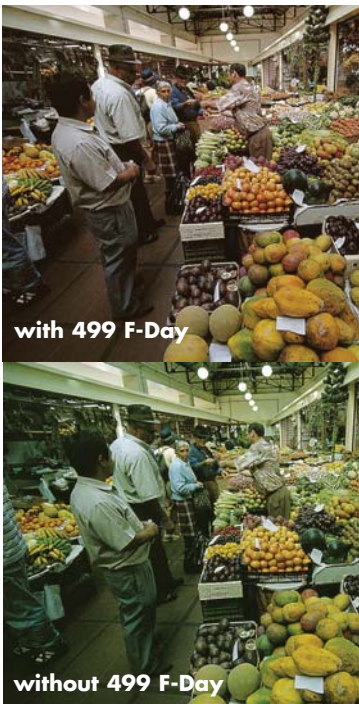

### UV Black Filter 403:

Not to be confused with the UV-blocking "UV Filter", the 403 passes UV A radiation (320 to 385 nm), but blocks visible light and looks pitch-black to our eyes. It is used with appropriately sensitized films in such applications as ultraviolet reflection photography in forensics or in materials research, but also as filters on UV-emitters for fluorescence photography. Depending on the illumination and on the film's sensitization, its filter factor is in the range of 8 to 20.

### UV Blocking Filter 415 (=2B):

This sharp-cutting, nearly colorless filter blocks UV radiation up to the limit of visible light. It is used in ultraviolet fluorescence photography for the prevention of unsharpness caused by the intense UV illumination (which is due to chromatic aberration in the UV range). It can also prevent the fluorescence that may occur in the cement between lens elements. Because of the usually rather colorful fluorescent subjects, the delicate yellow cast in color photographs is negligible. Its filter factor is 1.

### UV-Blocking Filter 420 (= 2A):

This even more stringent UV-blocking filter behaves like the 415 except that its filtering slope completely blocks the UV radiation all the way into the visible violet region. As a result, it has a noticeably yellow tint. It is used for fluorescence photography on black-and-white film, where it is even more effective. Its filter factor is 1.2.

### Digital UV-/IR-Blocking Filter 486:

This B+W Interference Filter has a completely colorless glass carrier coated with a number of extremely thin, partially reflecting layers with precisely computed thicknesses, similar to MC coating. The 486 does not block by means of absorption, but by interference of the unwanted UV- and IR radiation that is repeatedly reflected between these layers, affecting the wavelengths on both sides of the visible spectrum with a steep cut-off. It is used mainly on digital- and video cameras with CCD sensors without an integrated IR protection filter, because the IR sensitivity of the CCD sensor would otherwise cause color changes and unsharpness. That unsharpness results from the chromatic aberration of the lenses that are only corrected for visible light. In the visible range, the transmission curve is very high and straight. This filter is completely clear and it requires no increase in exposure. Its filter factor is 1.



## SPECIAL FILTERS

**Infrared-Blocking Filter 489**

This IR-blocking filter must not be confused with heat-resisting protection filters for projectors or spotlights. Instead, it is intended for use as protection for IR-sensitive CCD sensors or in the light path of illumination devices with low thermal characteristics. It suppresses infrared radiation  $\geq 780$  nm. Because it gradually begins to absorb infrared radiation at 600 nm, long-wave red light is slightly weakened, so that this filter has a subtle green tint. But in CCD applications, this can be readily corrected electronically. Its filter factor is approximately 1.2.

**Infrared Filter 092 (=89 B)**

The nearly opaque Infrared Filter 092, which looks dark purplish red when held in front of a light source, blocks visible light up to 650 nm, and passes only 50% of the radiation just below 700 nm (thus the dark red color). From 730 nm to 2000 nm, transmission is greater than 90%. This makes photographs of pure red and infrared images possible with the best utilization of the relatively low sensitivity of infrared films. As the sensitization of infrared black-and-white films barely extends beyond 1000 nm, the red portion that is transmitted still makes a relevant contribution to the exposure. That is why this filter is the preferred filter for pictorial photography on IR black-and-white film. Its filter factor is 20 to 40.

**Infrared Filter 093 (=87 C)**

This Infrared Filter blocks the entire visible spectrum, so to our eyes it looks completely opaque. Unlike the infrared filter described above, it makes pure infrared photographs possible without the visible red component. Its transmission only begins to exceed 1% at 800 nm, rising to 88% at 900 nm, and remains that high far beyond the upper limit of sensitization covered by infrared films. This filter is used less frequently in pictorial photography because of the dramatic loss of effective ISO. But in the scientific field, materials research and forensics, the limitation to a strictly infrared range is often important. The filter factor is very dependent on the illumination and on the characteristics of the film.

**Infrared Filter 099 (=16)**

The orange-colored 099 is the ideal filter for photography with infrared color film, which is also referred to as "False Color Film" because of its charming abstract color reproduction. It blocks large portions of short-wave radiation, up to 520 nm (blue, blue-green) and reaches its full transmission near 600 nm, which it retains far beyond the sensitization range of these films. This avoids the blue cast that is caused by the heightened sensitivity in this spectral range, and it leads to a better differentiation of colors. The charm of these infrared color photographs is partly due to the orange to red rendition of green vegetation, which is due in turn to the high infrared reflectivity of the chlorophyll in plants. The filter factor is highly dependent on the film and on the degree of infrared reflection of the subject.

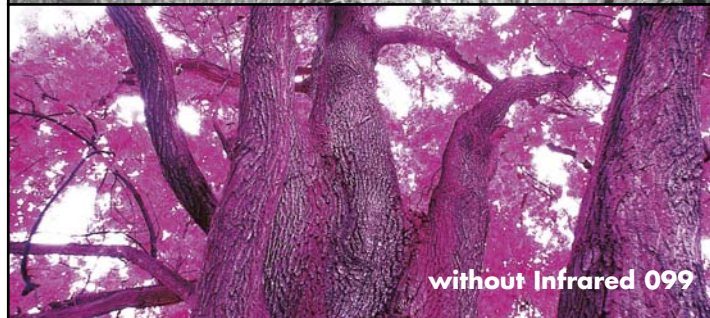

## BLACK & WHITE FILTERS

Because early black-and-white films did not render colors in the gray tones that corresponded to the brightness perception of human eyes, the use of yellow- and yellow-green filters was simply indispensable.

Today's panchromatically sensitized black-and-white films no longer require such a correction, at least not in daylight. In artificial light, however, the increased red component can distort the rendition in gray tones in critical cases by rendering blue tones too darkly and red tones too brightly. This can be remedied by the use of a light blue filter with halogen light or a medium blue filter with incandescent illumination. Yellow and yellow-green filters can bring more brilliance to landscape photographs and create better differentiation of green tones in vegetation. Yellow- and orange filters can magically transform cloudlets into clouds and cloud formations, and red filters can even raise them to dramatic thunderstorm strength or create moonlight effects. A very simple rule can be used to determine which filter should be used: To lighten a subject color, use a filter of the same color. To darken a subject color, use a filter of a complementary color. When two objects with different colors but with the same effective brightness are to be better differentiated in a black-and-white photograph, use the filter of the same color as the color that is to be rendered lighter in the photograph.



### Light Yellow Filter 021

This filter suppresses violet and attenuates blue. On the other hand, green, yellow, orange and red are reproduced in lighter shades. It is ideal for landscape photographs, since white clouds will contrast more against the darker blue sky, and the shades of green on plants are more differentiated. Freckles and skin blemishes in portraits can be attenuated, tans can be rendered lighter. Filter factor is approximately 1.5.

### Medium Yellow Filter 022

With stronger blue suppression, which extends into the blue-green, the effects described above are slightly stronger in the same types of applications. Clouds in the sky look very natural, but not yet dramatic. Distant views with light haze become clearer. An ideal filter, especially for landscape- and plant photographs. Filter factor is approximately 2.

### Dark Yellow Filter 023

Even greater blue suppression and the attenuation into the blue-green range for a further increase in the effects as 022. Interesting for snow scenes under a blue sky, because the darkened blue shadows in the snow make the shapes of the landscape look more dimensional. Freckles and skin blemishes are diminished but lips are rendered more pale (to compensate use a dark lipstick!) Filter factor is approximately 3.

### Yellow-Orange Filter 040

The effect of this filter is quite powerful. It darkens violet and blue very strongly, green strongly, it even darkens yellow-green a bit. Landscape- and architectural photographs have an increased, virtually "graphic" contrast, clouds in the sky already look dramatic. Because skin tones are strongly lightened in relation to the green tones of plants, this is a favored filter for nude photography outdoors. Filter factor is 4.

### Red-Orange Filter 041

The intensified effect of this filter borders on the abstract. It darkens a blue sky with clouds to resemble the mood of an impending thunderstorm. Architectural photographs gain clarity and drama. Also interesting for b&w close-up photographs of flowers, when dark yellow, orange or red blossoms have almost the same brightness as the surrounding greenery. Depending on the subject, filter factor is 4 to 5.



### Yellow-Green 060

Ideal for scenes where it is important to differentiate the green tonal values. The application is especially suited to landscape photography in the springtime because it enhances the light green color of the leaves. Due to its favorable effect on red tones, this filter is also suitable for portraits or group pictures taken in natural light. Filter factor is approx. 2.

### Green 061

This dark green filter creates distinct differentiations of green tones in late spring and summer. It is also recommended for floral pictures that are used graphically, for tonal separations in still-life photography, and for the correction of red tones in portraits with high-speed film. Filter factor is approx. 3.



## BLACK & WHITE FILTERS



Contrast without filter



B&W without filter



B&W with Green 060



B&W with Red 090

### Colors and Gray Shades

Black-and-white film should render all colors in shades of gray in such a way that their brightness values look natural. Older photographers remember the days when yellow filters were a must for landscape photographs and portraits. Even films that were sensitized “panchromatically”, ostensibly to match human brightness perception, rendered blues too lightly and reds too darkly. And though b&w film no longer has that shortcoming, filters are still necessary for controlling the photographer’s translation of colors into shades of gray. B&W photographs often lack impact because colors that are well differentiated in nature be equivalently luminous in shades of gray. For example, the red tiles on a roof and the green of nearby vegetation. But this can be managed. The color of the filter and its related colors are transmitted virtually undiminished, whereas their complementary colors are attenuated, so that they appear darker in the photo. When that loss of brightness is compensated in accordance with the filter factor, the result is a correct exposure that shows the colors related to the color of the filter as lighter shades of gray. Complementary colors will appear as darker tones.

### Filters and TTL Metering

Today nearly all SLR cameras feature TTL metering, which means through an attached filter as well. This metering method takes into account the loss of light absorbed by the filter, so that filter factors usually need not be applied. However, when the exposure is measured with a separate exposure meter, then the filter factor has to be taken into consideration. Still, with darker filters (very dense colors), exposure bracketing of  $\pm 1/2$  to  $\pm 1$  aperture stops is recommended, even with TTL exposure metering, because the spectral sensitivity of the metering cell can be significantly different from that of the film.

### Brightness vs. Color Contrast

Unlike color, b&w photographs only have brightness contrast, no color contrast. That is why in the photography of objects, for example, things that have different colors but the same brightness will have similar gray values. For instance, when there is a blue toy in the foreground and red dress with the same brightness in the background, they will be reproduced with the same gray values. This is referred to as insufficient tonal separation. Colored filters are helpful in such situations. First decide which object is to be rendered lighter and which one darker. Then select a filter color that 1) is similar to the color of the object that is to be shown lighter and that 2) is as complementary as possible to the object that is to be rendered darker. If the two colors are already complementary, like blue and orange, select a filter that is similar to that of the object that is to be rendered lighter. If the two main colors are not complementary, like blue and red, a compromise can be used. Blue filters lighten the blue color, but it also darkens red a little. But a green filter can also be used. While it would only lighten the related blue color a little, it would darken the red color more strongly than the blue would. You would have then achieved a good tonal separation with the lighter gray of the toy and a darker gray for the dress.

#### Light Blue 080

Recommended for the correction of artificial light with overtones of yellow-red such as with older photo lamps or normal household bulb illumination. It is also used to darken skin tones for portrait or nude photography under natural light. Filter factor is 1.5.

#### Medium Blue 081

Enhances the tonal rendition of the sky by emphasizing mist in valleys and transmitting light rays over water, fog, and haze. In addition, this filter is used for the tonal separation in still-life photography and the correction of the light spectrum from artificial light sources. Filter factor is 2.

#### Light Red 090 [25]

Ideal for enhancing contrast. In landscape and architectural photography, for example, it lets clouds stand out clearly against a darkened sky and drastically reducing distant haze. Also used for tonal separation in still-life photography. Filter factor is 5.

#### Red 091 [29]

This filter gives a surrealistic effect in landscape and architectural photography by producing a “storm-like” cloud effect, “moonlight” effect, and “wood” effect. It is indispensable for tonal separation in still-life photography and for the reproduction of documents which have become illegible. Filter factor is 8.

## SPECIAL FILTERS

### 499/403/415/420/080/099 SPECIAL FILTERS

| Filter Size (mm)               | 30.5   | 35.5   | 37     | 39     | 40.5   | 43     | 46     | 48     | 49     | 52     | 55     |
|--------------------------------|--------|--------|--------|--------|--------|--------|--------|--------|--------|--------|--------|
| 499 F-Day #BWFLD()             | 46.95  | 46.95  | 46.95  | 46.95  | 46.95  | 46.95  | 46.95  | 46.95  | 35.95  | 36.95  | 43.95  |
| 499 F-Day-W/A #BWFLD()EW       | —      | —      | —      | —      | —      | —      | —      | —      | 82.95  | 82.95  | 92.95  |
| 499 F-Day-SLIM #BWF LDS()      | —      | —      | —      | —      | —      | —      | —      | —      | 64.95  | 64.95  | 74.95  |
| 403 UV Black #BW403()          | 46.95  | 46.95  | 46.95  | 46.95  | 46.95  | 46.95  | 46.95  | 46.95  | 26.50  | 26.50  | 29.50  |
| 403 UV Black-W/A #BW403()EW    | —      | —      | —      | —      | —      | —      | —      | —      | 82.95  | 82.95  | 93.95  |
| 403 UV Black-SLIM #BW403S()    | —      | —      | —      | —      | —      | —      | —      | —      | 64.95  | 64.95  | 74.95  |
| 415 UV Blocking #BW415()       | 46.95  | 46.95  | 46.95  | 46.95  | 46.95  | 46.95  | 46.95  | 46.95  | 35.95  | 36.95  | 43.95  |
| 415 UV Blocking-W/A #BW415()EW | —      | —      | —      | —      | —      | —      | —      | —      | 82.95  | 82.95  | 92.95  |
| 415 UV Blocking-SLIM #BW415S() | —      | —      | —      | —      | —      | —      | —      | —      | 64.95  | 64.95  | 74.95  |
| 420 UV Blocking #BW420()       | 46.95  | 46.95  | 46.95  | 46.95  | 46.95  | 46.95  | 46.95  | 46.95  | 35.95  | 36.95  | 43.95  |
| 420 UV Blocking-W/A #BW420()EW | —      | —      | —      | —      | —      | —      | —      | —      | 82.95  | 82.95  | 92.95  |
| 420 UV Blocking-SLIM #BW420S() | —      | —      | —      | —      | —      | —      | —      | —      | 64.95  | 64.95  | 74.95  |
| 080 Light Blue #BW080()        | 46.95  | 46.95  | 46.95  | 46.95  | 46.95  | 46.95  | 46.95  | 46.95  | 35.95  | 36.95  | 43.95  |
| 080 Light Blue-W/A #BW080()EW  | —      | —      | —      | —      | —      | —      | —      | —      | 82.95  | 82.95  | 92.95  |
| 080 Light Blue-SLIM #BW080S()  | —      | —      | —      | —      | —      | —      | —      | —      | 64.95  | 64.95  | 74.95  |
| 099 Infrared #BW099()          | 24.95  | 24.95  | 24.95  | 24.95  | 24.95  | 24.95  | 24.95  | 24.95  | 19.95  | 19.95  | 22.95  |
| 099 Infrared-W/A #BW099()EW    | —      | —      | —      | —      | —      | —      | —      | —      | 49.95  | 49.95  | 56.95  |
| 099 Infrared-SLIM #BW099S()    | —      | —      | —      | —      | —      | —      | —      | —      | 19.95  | 44.95  | 49.95  |
| Filter Size (mm)               | 58     | 60     | 62     | 67     | 72     | 77     | 82     | 86     | 95     | 105    | 112    |
| 499 F-Day #BWFLD()             | 45.95  | 74.95  | 72.95  | 74.95  | 94.95  | 104.95 | 129.95 | 146.95 | 194.95 | 219.95 | 299.95 |
| 499 F-Day-W/A #BWFLD()EW       | 109.95 | —      | 124.95 | 128.95 | 149.95 | 154.95 | 179.95 | 199.95 | 234.95 | 279.95 | —      |
| 499 F-Day-SLIM #BWF LDS()      | 94.95  | 134.95 | 102.95 | 106.95 | 129.95 | 137.95 | 149.95 | 164.95 | —      | 234.95 | —      |
| 403 UV Black #BW403()          | 45.95  | 74.95  | 72.95  | 79.95  | 94.95  | 104.95 | 129.95 | 146.95 | 194.95 | 219.95 | 299.95 |
| 403 UV Black-W/A #BW403()EW    | 109.95 | —      | 124.95 | 128.95 | 149.95 | 154.95 | 179.95 | 199.95 | 234.95 | 279.95 | —      |
| 403 UV Black-SLIM #BW403S()    | 94.95  | 134.95 | 102.95 | 106.95 | 129.95 | 137.95 | 149.95 | 164.95 | 206.95 | 219.95 | —      |
| 415 UV Blocking #BW415()       | 45.95  | 74.95  | 72.95  | 74.95  | 94.95  | 104.95 | —      | —      | 194.95 | —      | —      |
| 415 UV Blocking-W/A #BW415()EW | 109.95 | —      | 124.95 | 128.95 | 149.95 | 154.95 | 179.95 | 199.95 | 234.95 | 279.95 | —      |
| 415 UV Blocking-SLIM #BW415S() | 94.95  | 134.95 | 102.95 | 106.95 | 129.95 | —      | —      | 164.95 | 206.95 | 214.95 | —      |
| 420 UV Blocking #BW420()       | 45.95  | 74.95  | 72.95  | 74.95  | 94.95  | 104.95 | 129.95 | 146.95 | 194.95 | 219.95 | 299.95 |
| 420 UV Blocking-W/A #BW420()EW | 109.95 | —      | 124.95 | 128.95 | 149.95 | 154.95 | 179.95 | 199.95 | 234.95 | 279.95 | —      |
| 420 UV Blocking-SLIM #BW420S() | 94.95  | 134.95 | 102.95 | 106.95 | 129.95 | 137.95 | 149.95 | 164.95 | 206.95 | 234.95 | —      |
| 080 Light Blue #BW080()        | 45.95  | 74.95  | 72.95  | 74.95  | 94.95  | 104.95 | —      | —      | —      | —      | —      |
| 080 Light Blue-W/A #BW080()EW  | 109.95 | —      | 124.95 | 128.95 | 149.95 | 154.95 | 179.95 | 199.95 | 234.95 | —      | —      |
| 080 Light Blue-SLIM #BW080S()  | 99.95  | 134.95 | 102.95 | 106.95 | 129.95 | 137.95 | 149.95 | 164.95 | 234.95 | —      | —      |
| 099 Infrared #BW099()          | 24.95  | 39.95  | 29.95  | 38.95  | 46.95  | 52.95  | 72.95  | 79.95  | 109.95 | 134.95 | 174.95 |
| 099 Infrared-W/A #BW099()EW    | 67.95  | —      | 76.95  | 79.95  | 92.95  | 94.95  | 112.95 | 119.95 | 139.95 | 169.95 | —      |
| 099 Infrared-SLIM #BW099S()    | 67.95  | 82.95  | 69.95  | 69.95  | 79.95  | 84.95  | 97.95  | 106.95 | 142.95 | 164.95 | —      |

### 092/093/486/489 SPECIAL FILTERS

| Filter Size (mm)       | 30.5   | 35.5   | 37     | 39     | 40.5   | 43     | 46     | 48     | 49     | 52     | 55     |
|------------------------|--------|--------|--------|--------|--------|--------|--------|--------|--------|--------|--------|
| Standard #BW()()       | 59.95  | 59.95  | 59.95  | 59.95  | 59.95  | 59.95  | 59.95  | 59.95  | 84.95  | 54.95  | 104.95 |
| Standard-W/A #BW()()EW | —      | —      | —      | —      | —      | —      | —      | —      | 49.95  | 49.95  | 56.95  |
| Standard-SLIM #BW()S() | —      | —      | —      | —      | —      | —      | —      | —      | 102.95 | 102.95 | 122.95 |
| Filter Size (mm)       | 58     | 60     | 62     | 67     | 72     | 77     | 82     | 86     | 95     | 105    | 112    |
| Standard #BW()()       | 107.95 | 112.95 | 112.95 | 124.95 | 149.95 | 174.95 | 194.95 | 214.95 | 299.95 | 324.95 | 379.95 |
| Standard-W/A #BW()()EW | 67.95  | —      | 76.95  | 79.95  | 92.95  | 94.95  | 112.95 | 119.95 | 139.95 | 169.95 | —      |
| Standard-SLIM #BW()S() | 134.95 | 144.95 | 139.95 | 149.95 | 179.95 | 199.95 | 214.95 | 229.95 | 294.95 | 334.95 | —      |



For Any Inquiries Regarding Your Order, Call Our Customer Service:  
 (800) 221-5743 • (212) 239-7765 • FAX: (800) 947-2215 • (212) 239-7549

## BLACK & WHITE FILTERS

### YELLOW, ORANGE, GREEN, BLUE, RED FILTERS

| Filter Size (mm)        | 30.5  | 35.5  | 37    | 39    | 40.5  | 43    | 46    | 48    | 49    | 52    | 55    |
|-------------------------|-------|-------|-------|-------|-------|-------|-------|-------|-------|-------|-------|
| Standard #BW()()        | 24.95 | 24.95 | 24.95 | 24.95 | 24.95 | 24.95 | 24.95 | 24.95 | 19.95 | 19.95 | 22.95 |
| Standard-SLIM #BW()S()  | —     | —     | —     | —     | —     | —     | —     | —     | 44.95 | 44.95 | 49.95 |
| Standard- W/A #BW()()EW | —     | —     | —     | —     | —     | —     | —     | —     | 49.95 | 49.95 | 56.95 |
| MRC #BW()MC()           | 39.95 | 39.95 | 39.95 | 39.95 | 39.95 | 39.95 | 39.95 | 39.95 | 29.95 | 29.95 | 32.95 |
| MRC-SLIM #BW()MCS()     | —     | —     | —     | —     | —     | —     | —     | —     | 52.95 | 52.95 | 69.95 |
| MRC-W/A #BW()MC()EW     | —     | —     | —     | —     | —     | —     | —     | —     | 59.95 | 59.95 | 77.95 |

### YELLOW, ORANGE, GREEN, BLUE, RED FILTERS

| Filter Size (mm)        | 58    | 60    | 62    | 67     | 72     | 77     | 82     | 86     | 95     | 105    | 112    |
|-------------------------|-------|-------|-------|--------|--------|--------|--------|--------|--------|--------|--------|
| Standard #BW()()        | 24.95 | 39.95 | 29.95 | 36.95  | 46.95  | 52.95  | 72.95  | 79.95  | 109.95 | 134.95 | 174.95 |
| Standard-SLIM #BW()S()  | 64.95 | 82.95 | 69.95 | 69.95  | 74.95  | 84.95  | 97.95  | 106.95 | 142.95 | 164.95 | —      |
| Standard- W/A #BW()()EW | 67.95 | —     | 76.95 | 79.95  | 93.95  | 94.95  | 112.95 | 119.95 | 139.95 | 169.95 | —      |
| MRC #BW()MC()           | 34.95 | 59.95 | 42.95 | 49.95  | 62.95  | 79.95  | 104.95 | 109.95 | 154.95 | 179.95 | —      |
| MRC-SLIM #BW()MCS()     | 79.95 | 99.95 | 89.95 | 96.95  | 107.95 | 112.95 | 124.95 | 142.95 | 159.95 | 192.95 | —      |
| MRC-W/A #BW()MC()EW     | 89.95 | —     | 99.95 | 109.95 | 124.95 | 124.95 | 144.95 | 159.95 | 179.95 | 219.95 | —      |

### YELLOW, ORANGE, GREEN, BLUE, RED FILTERS

| Filter Size (mm)        | 122    | Bay 1 | Bay 2 | Bay 3 | Bay 6  | Bay 50 | Bay 60 | Bay 70 | Bay 104 | Series 7 | Series 93 |
|-------------------------|--------|-------|-------|-------|--------|--------|--------|--------|---------|----------|-----------|
| Standard #BW()()        | 179.95 | 32.95 | 37.95 | 42.95 | 154.95 | —      | 132.95 | 149.95 | —       | 27.95    | 84.95     |
| Standard-SLIM #BW()S()  | —      | —     | —     | —     | —      | —      | —      | —      | —       | —        | —         |
| Standard- W/A #BW()()EW | —      | —     | —     | —     | —      | —      | —      | —      | —       | —        | —         |
| MRC #BW()MC()           | —      | 42.95 | 49.95 | 56.95 | 194.95 | —      | 144.95 | 174.95 | —       | 42.95    | 119.95    |
| MRC-SLIM #BW()MCS()     | —      | —     | —     | —     | —      | —      | —      | —      | —       | —        | —         |
| MRC-W/A #BW()MC()EW     | —      | —     | —     | —     | —      | —      | —      | —      | —       | —        | —         |

1. In the first parenthesis insert the color filter type. For Light Yellow insert 021, Medium Yellow (022), Dark Yellow (023), Yellow-Orange (040), Red Orange (041), Yellow-Green (060), Green (061), Medium Blue (081), Light Red (090) or Red (091). In the second parenthesis insert the filter size.

For example, a 72mm Medium Yellow MRC-Slim filter would be BW022MCS37.

2. For Bay sizes insert just the letter B and the number. For example, a Bay 6 Standard Green filter would be BW061B6.

3. For Series 7 and 93, insert just the letter S and the number. For example, Series 7 MRC Yellow-Orange filter is BW040MCS7.

4. Series 5.5, Series 6, Series 8 and Series 9 are also available special order.



## GRADUATED FILTERS

B+W graduated color filters are primarily intended for color photography and are used mostly for photography on color transparency film. When color negative films are used, the lab should be informed, so it won't "correct" the effects from the image.

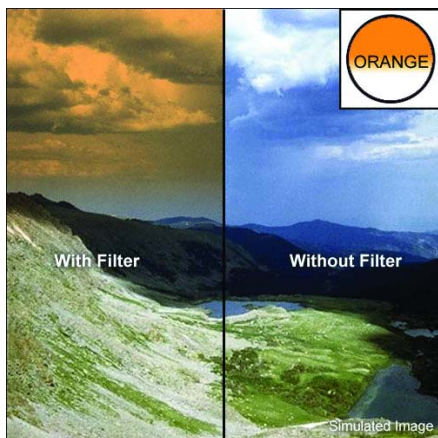

Of course they can also be used with black & white films, often with very interest effects. Fabricated from high-quality CR-39 acrylic, these filters are color toned in one half of the filter which is smoothly graduated into the clear portion. Colored and clear filter portions can be brought into the desired position by rotating the mount. They can also be combined with other filters or other color graduated filters.

Two color graduated filters rotated by 180° to each other allow a picture composition of colors to fade into each other.

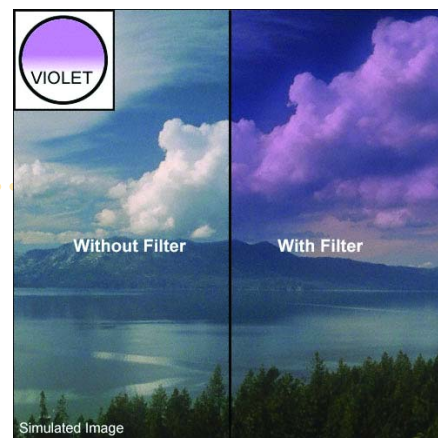
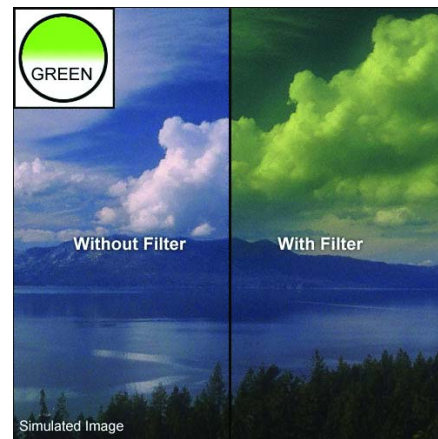

### Graduated Gray 501

The neutral gray half of this filter transmits 50% of the incoming light, so that it darkens the respective portion of the subject by one f-stop without altering its colors. For example, when the sky is too bright in relation to the landscape, this is an ideal amount for good detail rendition in the clouds and for preventing the sky from being "washed out" by over-exposure.

### Graduated Dark Gray 502

Because it attenuates the light twice as much as the Graduated Gray 501, by two aperture stops (it transmits 25% of the light), this graduated filter already produces quite dramatic effects. Because of the increased differences in brightness, it is even more important for the horizon line not be positioned too far from the center of the image.

### Graduated Orange 524

The somewhat more delicate coloring of this graduated filter is recommended when the correction of the sunset mood is not to be pronounced, or when a certain amount of red coloring is already present, so that only a small enhancement would be sufficient. With heavy gray thunderstorm clouds it can produce a nearly awesome storm mood.

### Graduated Violet 543

With grazing light and a sparse exposure, this graduated filter with its somewhat unnatural color can produce a ghostly, macabre moonlight effect. So it is more suitable for abstractions rather than enhancements of natural moods. An interesting effect can be achieved by using it in combination with Graduated Green 561 for the lower half of the image.

### Graduated Tobacco 550

Those who have experienced a sandstorm in the desert will never forget that mood. With this graduated filter, one can approximate that mood: slightly threatening, yet still pleasantly "warm". The tobacco color is discreet, not overly colorful, so that it never appears gross nor overlay the existing colors as much as more intense graduated colors.

### Graduated Green 561

Because of its vegetation color, this graduated filter is especially suitable for the lower half of an image when used in combination with other graduated filters that are being used to darken or to alter the color of the sky. With such filter combinations, the TTL exposure metering should be performed with filters in position on the lens.

### Graduated Blue 581

This is an excellent solution when the sky isn't blue enough. It can be used effectively in combination with another graduated filter for the lower half of the image, so that in combination the sky will not be rendered too brightly or too pale. Example: sand dunes by the sea; using a Graduated Tobacco 550 for the lower half and a Graduated Blue 581 for the upper half of the image.

### Graduated Red 590

This graduated filter is often referred to as the "sunset filter", because it can simulate a missing red sky in the evening or in the morning, or to enhance one that is too pale when the line of sight is towards the sun. By the sea or by a lake, the horizon line should be positioned high enough for the red portion of the filter also to cover the reflection of the water.

## GRADUATED FILTERS



with Graduated Gray 501

with Graduated Blue 581

with Blue 581 and Tabac 550

FILTERS

341

### GRADUATED FILTERS

| Filter Size (mm)                | 49    | 52    | 55    | 58    | 60    | 62    | 67    | 72    | 77    | 82     | 86     |
|---------------------------------|-------|-------|-------|-------|-------|-------|-------|-------|-------|--------|--------|
| Graduated Gray 501 #BW501()     | 45.95 | 48.95 | 52.95 | 54.95 | 64.95 | 57.95 | 64.95 | 74.95 | 92.95 | 119.95 | 136.95 |
| Grad. Dark Gray 502 #BW502()    | 45.95 | 48.95 | 52.95 | 54.95 | 64.95 | 57.95 | 64.95 | 74.95 | 92.95 | 119.95 | 136.95 |
| Graduated Orange 524 #BWGO()    | 45.95 | 48.95 | 52.95 | 54.95 | 64.95 | 57.95 | 64.95 | 74.95 | 92.95 | 119.95 | 136.95 |
| Graduated Violet 543 #BWGV()    | 45.95 | 48.95 | 52.95 | 54.95 | 64.95 | 57.95 | 64.95 | 74.95 | 92.95 | 119.95 | 136.95 |
| Graduated Tobacco 550 #BWGTO()  | 45.95 | 48.95 | 52.95 | 54.95 | 64.95 | 57.95 | 64.95 | 74.95 | 92.95 | 119.95 | 136.95 |
| Grad. Yellow-Green 560 #BWGYG() | 45.95 | 48.95 | 52.95 | 54.95 | 64.95 | 57.95 | 64.95 | 74.95 | 92.95 | 119.95 | 136.95 |
| Graduated Green 561 #BWGGR()    | 45.95 | 48.95 | 52.95 | 54.95 | 64.95 | 57.95 | 64.95 | 74.95 | 92.95 | 119.95 | 136.95 |
| Graduated Blue 581 #BWGBL()     | 45.95 | 48.95 | 52.95 | 54.95 | 64.95 | 57.95 | 64.95 | 74.95 | 92.95 | 119.95 | 136.95 |
| Graduated Lilac 585 #BWGL()     | 45.95 | 48.95 | 52.95 | 54.95 | 64.95 | 57.95 | 64.95 | 74.95 | 92.95 | 119.95 | 136.95 |
| Graduated Red 590 #BWGR()       | 45.95 | 48.95 | 52.95 | 54.95 | 64.95 | 57.95 | 64.95 | 74.95 | 92.95 | 119.95 | 136.95 |

## B+W FILTERS ACCESSORIES

### Plastic Filter Cases

Thanks to their transparent lids, these handy flat filter cases, made of impact-resistant plastic material, let you see right away which filter is stored inside. A foam rubber insert keeps filters from rattling. A filter contained in such a case can be carried in a pocket without any problems.

#### Plastic Filter Case (BWFC52)

For 49mm and 52mm filters .....5.95

#### Plastic Filter Case (BWFC77)

For 55, 58, 62, 67, 72 and 77mm filters .....5.95

#### Plastic Filter Case (BWFC105)

For 82, 86, 95 and 105mm filters .....5.95

### 4-Filter Plastic Case

The same case as above, except this case has an insert that holds four filters. Recesses keep the filters from touching each other. Finger indentations permit the easy removal of filters from their recesses. Available with a choice of insert for 49, 52, 55 and 58mm filters ....CALL

#### B6 Filter Pouch (BWFPB6)

This folding padded filter pouch is made of a flexible plastic material with snap fasteners. Its see-through pockets hold six filters or close-up lenses in sizes up to 62mm. The pouch easily fits in any gadget bag, for instance readily accessible in a front compartment .....14.95

### Nylon Fabric Filter Pouches



These nylon fabric filter pouches are made of padded, water-and-abrasion-resisting Nylon fabric with practical Velcro closures and a

white space for identification.

#### E1 Filter Pouch (BWFPPE1)

Holds one filter up to 77mm .....9.95

#### E2 Filter Pouch (BWFPPE2)

Holds one filter up to 112mm .....9.95

## SOFT FOCUS FILTERS

Soft focus filters are popular lens attachments. Although they have a wide variety of applications, there is a tendency to use them to achieve a stronger or lower contrast level. However, images created with soft focus filters with lens shaped structures in its surface retain their sharpness while softening contours and causing a pleasing halo effect around the highlights. This effect remains unchanged from the lens aperture opening with these types of filters.



Special-effect filters which are slightly colored or have concentric rings in the glass create a look that is similar to a slightly-out-of-focus effect. This increases with wider lens aperture openings and diminishes by stopping down.

Soft-focus and fog filters are not only useful for still-life and romantic portrait photography, they can produce a surrealistic atmosphere for everyday subjects too. Partial soft focus via a filter with a clear center can help concentrate the attention of the viewer to a specific picture subject. In this case, using larger lens openings to create a nice flow between the sharp and less sharp portions of the image is recommended. Black and white pictures taken with soft focus or fog filters appear slightly dull. Underexposing can help remedy this.

### Zeiss Softar 1 and 2

Despite softening of the highlights, the basic focus remains sharp up to the edges with this classic soft focus accessory — an advantage which makes focusing easy. The degree of softening is not affected by the aperture setting. Tiny lens-shaped structures in the glass of the Softar create this pleasing effect.

### Fog Filters 1 and 2

Pictures taken with the fog filter appear to have been taken in a fine, bright mist. Whitening colors and soft lights create a romantic atmosphere which can enhance the tone of the image in an unusual way. In backlit situations, there is an even stronger effect. The three densities allow for variations.

### Soft Image 655

Subject contours “flow” markedly soft with the Soft Image filter. Prominent halos form around light sources and reflections, and bright parts of the subject acquire a noticeable veil of light. This effect is maintained even when the lens is stopped down. Recommended for portraits and for backlit situations.



without Softar

with Softar 1

with Softar 2

with Soft Image 655

### ZEISS SOFTAR/FOG/SOFT IMAGE FILTERS

| Filter Size (mm)        | 43    | 46    | 49     | 52     | 55     | 58     | B60 | 62     | 67     |
|-------------------------|-------|-------|--------|--------|--------|--------|-----|--------|--------|
| Zeiss Softar 1 #BWZS1() | —     | —     | 184.95 | 184.95 | 199.95 | 199.95 | —   | 199.95 | 214.95 |
| Zeiss Softar 2 #BWZS2() | —     | —     | 184.95 | 184.95 | 199.95 | 199.95 | —   | 199.95 | 214.95 |
| Fog 1 #BWF1()           | 24.95 | 24.95 | 24.95  | 26.95  | 29.95  | 32.95  | —   | 36.95  | 37.95  |
| Fog 2 #BWF2()           | 24.95 | 24.95 | 24.95  | 26.95  | 29.95  | 32.95  | —   | 36.95  | 37.95  |
| Soft Image 655          | 22.95 | 22.00 | 22.95  | 23.95  | 23.95  | 25.95  | —   | 31.95  | 35.95  |

In the parenthesis insert the filter size. For example, a 39mm Zeiss Softar 1 filter would be BWZS139.



## CROSS SCREEN & PRISM FILTERS

### 3x Multi-Image Prism

The three wedges of equal size that meet at the center of this prism attachment are made of high-grade optical glass, and they deflect the light in such a way that the lens looks at the same subject in three directions. The lens should have an approximately normal focal length (50mm). The result will be a triple image with pleasingly merging contours. The positioning of the images can be varied by rotating the mount of the attachment.

### 5x Multi-Image Prism

Four prism wedges around a square plano-parallel center correspondingly generate five nearly identical images: one in the center and four around the periphery, all with softly merging contours. The most suitable lens is one with a normal focal length, in order for the outer four repeated images to be the same as the central one. The filter can also be rotated for the best arrangement of the outer images, and is very popular for use on video camcorders.



Simulated Image

### 6x Multi-Image Prism

In this prism attachment, the central plano-parallel section is surrounded by 5 wedges, so that the final picture will consist of a central image repeated five times around the perimeter; a total of six images with softly merging edges. Like the other attachments, it should be used on a lens of approximately normal length, and can be rotated.

### CROSS SCREEN & MULTI-IMAGE FILTERS

| Filter Size (mm)             | 39    | 40.5  | 43    | 46    | 49    | 52    | 55    | 58    | 60    | 62    | 67    | 72    | 77    |
|------------------------------|-------|-------|-------|-------|-------|-------|-------|-------|-------|-------|-------|-------|-------|
| 4x Cross Screen #BWCS4()     | 32.95 | 33.00 | 33.00 | 33.00 | 33.00 | 32.95 | 34.95 | 37.95 | 47.95 | 42.95 | 44.95 | 52.95 | 59.95 |
| 6x Cross Screen #BWCS6()     | 32.95 | 33.00 | 33.00 | 33.00 | 33.00 | 32.95 | 34.95 | 37.95 | 47.95 | 42.95 | 44.95 | 52.95 | 59.95 |
| 8x Cross Screen #BWCS6()     | 32.95 | 33.00 | 33.00 | 33.00 | 33.00 | 32.95 | 34.95 | 37.95 | 47.95 | 42.95 | 44.95 | 52.95 | 59.95 |
| 3x Multi-Image Prism #BWP3() | —     | —     | —     | —     | 44.95 | 44.95 | 49.95 | 52.95 | —     | 64.95 | 69.95 | 74.95 | 79.95 |
| 5x Multi-Image Prism #BWP5() | —     | —     | —     | —     | 44.95 | 44.95 | 49.95 | 52.95 | —     | 64.95 | 69.95 | 74.95 | 79.95 |
| 6x Multi-Image Prism #BWP6() | —     | —     | —     | —     | 44.95 | 44.95 | 49.95 | 52.95 | —     | 64.95 | 69.95 | 74.95 | 79.95 |

In the parenthesis insert the filter size. For example, a 55mm 5x Multi-Image Prism would be BWP555.

### 4x Cross Screen

The star patterns created around light sources by star screens are not spread out as colorfully as those created by the Spectra series. Instead, their colors are less pronounced. The rays begin right at the light sources, they are very long and they are most effective when they are not vertical and horizontal, but at an angle of approximately 45° to the vertical axis.

### 6x Cross Screen

The star pattern produced by this screen is similar to that of the 4x except that it generates 6 beams from light sources and reflections at an angle of 60° to one another. Here too the light rays emanate right at the light sources, whereas there is a small separation when Spectra filters are used.

### 8x Cross Screen

Like two 4-beam star screens superimposed at a rotational angle of 45°, this star screen generates eight star beams. Therefore, as is the case with multi-beam Spectra filters, there should only be a few light sources within the image area and the background should have large dark areas in order for the star beams to remain recognizable.

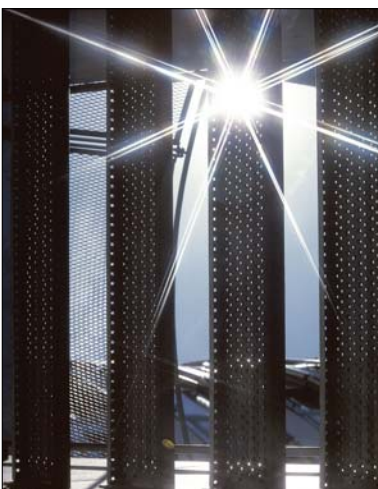

## PRISM FILTERS

To explore certain domains photographically, to make things become visible in a way and with a richness in details that is almost imperceptible to our bare eyes can be incredibly exciting. Using inexpensive close-up lenses that take up hardly any space in the gadget bag, the range of applications, especially of lensed with normal or short telephoto focal lengths, can be expanded dramatically.

Compared to extension tubes, close-up lenses can be more desirable, not only because of their lower price, weight, and size, but also because of the clearly better image quality that can be achieved at reproduction ratios of up to 1:2.5. The extremely strong Macro Lens can even be used to reproduce subjects in the macro range at nearly 1:1, if a small reduction of sharpness in the corners of the frame is acceptable (because of the very shallow depth of field, the background in most macro photographs is completely unsharp anyway).

### Close-Up #1

With +1 diopter, it is ideal for telephoto and zoom lenses with a near focusing distance of approximately  $3\frac{1}{4}'$ , resulting in a focusing range without a gap. Ideal for lenses with focal lengths between 85mm (up to approximately 1:5) and 200mm (up to approximately 1:3).

### Close-Up #2

The +2 diopter of this close-up lens focus at a distance of  $1\frac{1}{2}'$  with the lens focused at infinity. For the normal lens it is a stepless extension of its close-up range up to approximately 1:4.5. On short to medium telephoto lenses it seamlessly extends the Close-Up #1 range (with an 85mm lens to approximately 1:3.5 and with a 135mm lens to 1:2.5).

### Close-Up #3

With +1 diopter, it is ideal for telephoto and zoom lenses with a near focusing distance of approximately  $3\frac{1}{4}'$ , resulting in a focusing range without a gap. Ideal for lenses with focal lengths between 85mm (up to approximately 1:5) and 200mm (up to approximately 1:3).

### Close-Up #4

The +4 diopters of this close-up lens are the right power for closer focusing with a 50mm lens (up to 1:3) when you have reached the limit with Close-Up #2. With 85mm (up to approx. 1:2.1) and 100mm (up to 1:1.9) telephoto lenses, it is the highest power, and it should be used with the main lens stopped down to at least f/8.

### Close-Up #5

With +5 diopters, this filter serves for the seamless extension of the range provided by the #3 close-up lens on a 35mm main lens (up to 1:3.5). If you can tolerate a small gap after the #2 close-up lens on a 50mm main lens (1:4), then you enter a little further into the macro range with the #5 instead of the #4 (up to 1:2.6).

### Macro Lens

The +10 diopter power makes it possible to explore true macro ranges without the need for an expensive special lens, in order to reproduce tiny subjects at enormous proportions (approx. 1:2 to 1:1.5). Apertures of f/8 or f/11 are recommended for good corner-to-corner sharpness. Because of its great power, it is also suitable for use with digital cameras.

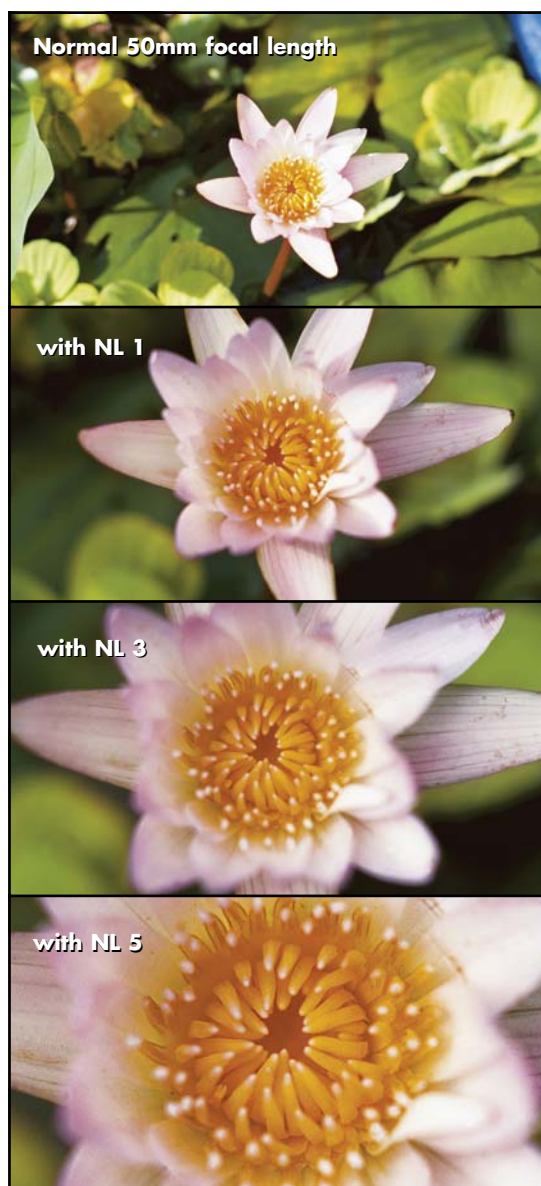



## CLOSE-UP FILTERS

| <b>#1/#2/#3/#4 CLOSE-UP FILTERS</b> |       |       |       |       |       |        |        |        |         |          |           |
|-------------------------------------|-------|-------|-------|-------|-------|--------|--------|--------|---------|----------|-----------|
| Filter Size (mm)                    | 30.5  | 35.5  | 37    | 39    | 40.5  | 43     | 46     | 48     | 49      | 52       | 55        |
| Standard #BW()<br>( )               | —     | —     | —     | —     | —     | 24.95  | 24.95  | 24.95  | 19.95   | 19.95    | 22.95     |
| Standard-W/A #BW()<br>( )EW         | —     | —     | —     | —     | —     | —      | —      | —      | —       | —        | —         |
| MRC #BW()<br>( )MC( )               | —     | —     | —     | —     | —     | —      | —      | —      | —       | —        | —         |
| MRC-W/A #BW()<br>( )MC( )EW         | —     | —     | —     | —     | —     | —      | —      | —      | —       | —        | —         |
| Filter Size (mm)                    | 58    | 60    | 62    | 67    | 72    | 77     | 82     | 86     | 95      | 105      | 112       |
| Standard #BW()<br>( )               | 24.95 | 39.95 | 29.95 | 36.95 | 46.95 | 52.95  | —      | —      | —       | —        | —         |
| Standard-W/A #BW()<br>( )EW         | —     | —     | —     | —     | —     | —      | —      | —      | —       | —        | —         |
| MRC #BW()<br>( )MC( )               | —     | —     | —     | —     | —     | —      | —      | —      | —       | —        | —         |
| MRC-W/A #BW()<br>( )MC( )EW         | —     | —     | —     | —     | —     | —      | —      | —      | —       | —        | —         |
| Filter Size (mm)                    | 122   | Bay 1 | Bay 2 | Bay 3 | Bay 6 | Bay 50 | Bay 60 | Bay 70 | Bay 104 | Series 7 | Series 93 |
| Standard #BW()<br>( )               | —     | —     | —     | —     | —     | —      | —      | —      | —       | 27.95    | —         |
| Standard-W/A #BW()<br>( )EW         | —     | —     | —     | —     | —     | —      | —      | —      | —       | —        | —         |
| MRC #BW()<br>( )MC( )               | —     | —     | —     | —     | —     | —      | —      | —      | —       | —        | —         |
| MRC-W/A #BW()<br>( )MC( )EW         | —     | —     | —     | —     | —     | —      | —      | —      | —       | —        | —         |

1. In the first parenthesis insert close-up power (CU1, CU2, CU3 or CU4). In the second parenthesis insert the filter size.

For example, a standard 46mm #2 Close-up filter would be BWCU246.

2. For Bay sizes insert the close-up power (CU1, CU2, CU3, CU4), the letter B and the number. For example, a Bay 1 Close-Up #2 would be BWCU2B1.

3. For Series 7 and 93, insert close-up power (CU1, CU2, CU3, CU4), the letter S and the number. For example, a Close-Up #3 in Series 7 is BWCU3S7.

| <b>#5 CLOSE-UP &amp; MACRO LENS (10X)</b> |       |       |       |       |       |        |        |        |         |          |           |
|---|-------|-------|-------|-------|-------|--------|--------|--------|---------|----------|-----------|
| Filter Size (mm)                          | 30.5  | 35.5  | 37    | 39    | 40.5  | 43     | 46     | 48     | 49      | 52       | 55        |
| Close-Up #5 #BWCU5()<br>( )               | —     | —     | —     | —     | —     | 24.95  | 24.95  | 32.95  | 27.95   | 27.95    | 29.95     |
| Close-Up #5 WA #BWCU5()<br>( )EW          | —     | —     | —     | —     | —     | —      | —      | —      | —       | —        | —         |
| Macro Lens #BWML()<br>( )                 | —     | —     | —     | —     | —     | —      | —      | —      | 35.95   | 36.95    | 43.95     |
| Macro Lens WA #BWML()<br>( )EW            | —     | —     | —     | —     | —     | —      | —      | —      | —       | —        | —         |
| Filter Size (mm)                          | 58    | 60    | 62    | 67    | 72    | 77     | 82     | 86     | 95      | 105      | 112       |
| Close-Up #5 #BWCU5()<br>( )               | 34.95 | 47.95 | 39.95 | 44.95 | 49.95 | 59.95  | —      | —      | —       | —        | —         |
| Close-Up #5 WA #BWCU5()<br>( )EW          | —     | —     | —     | —     | —     | —      | —      | —      | —       | —        | —         |
| Macro Lens #BWML()<br>( )                 | 45.95 | —     | —     | —     | —     | —      | —      | —      | —       | —        | —         |
| Macro Lens WA #BWML()<br>( )EW            | —     | —     | —     | —     | —     | —      | —      | —      | —       | —        | —         |
| Filter Size (mm)                          | 122   | Bay 1 | Bay 2 | Bay 3 | Bay 6 | Bay 50 | Bay 60 | Bay 70 | Bay 104 | Series 7 | Series 93 |
| Close-Up #5 #BWCU5()<br>( )               | —     | —     | —     | —     | —     | —      | —      | —      | —       | —        | —         |
| Close-Up #5 WA #BWCU5()<br>( )EW          | —     | —     | —     | —     | —     | —      | —      | —      | —       | —        | —         |
| Macro Lens #BWML()<br>( )                 | —     | —     | —     | —     | —     | —      | —      | —      | —       | —        | —         |
| Macro Lens WA #BWML()<br>( )EW            | —     | —     | —     | —     | —     | —      | —      | —      | —       | —        | —         |

In the parenthesis insert the filter size. For example, a 72mm Macro lens filter would be BWML72.

## CREATIVE FILTER SYSTEM

### **Optical Resin Filters for Photo, Digital and Video**

Invented by professional photographer Jean Coquin, Cokin filters is the world's leading range of special effect filters suitable for SLR, video, medium and large format camera systems. By using square filters, which fit into a holder and are attached to a lens via an adapter ring, the photographer has a number of immediate advantages:

- a) there is no need to duplicate filters to fit different size lenses,
- b) up to three filters can be used at once to create unique effects,
- c) the photographer has control over the positioning of the effect on the photograph.

This easy-to-use system, with a complete range of over 160 creative filters made of a high quality optical material, allow amateurs and professionals alike to create fantastic images. But this system, as versatile as it is, cannot fulfil its optimum effectiveness without your own personal and unique approach of creativity, imagination and dreams. Indeed, thanks to the Cokin Creative Filter System, each image can be modified and enhanced by your own creative input. Cokin shows you the way to live your own dreams: enter into the world of fantasy and creative images.

Whatever kind of SLR camera you use - autofocus or manual - Cokin "A" or "P" filter-holders fit perfectly on all lenses with diameters from 36 to 82mm, using a simple adapter ring. The "X-Pro" Series fits lens diameters from 62-118mm.



The heart of the Cokin creative system is the filter-holder. Once attached to the lens, thanks to an adapter ring, it can carry not only round and square filters but also modular accessories (modular hood, coupling ring etc). The notches found both on the filter-holder and on the edge of round filters enable you to rotate the filter to just the right position. Square filters slide within filter-holder slots, in order to de-center special effects.

The modular lens hood intensifies, contrasts and eliminates unwanted reflections. It fits simply onto the filter-holder by just pressing on the upper and lower parts of the lens hood. You can attach several modular hoods to one another, depending on the focal length of your lens. The coupling ring enables you to attach a second filter -holder, thereby increasing the number of filters used. The coupling ring slides into the filter-holder's outer slot. It is particularly useful for orientating square filters in different directions (graduated, multi-image filters etc).

#### **How the Cokin System Works:**

The first thing you have to decide is—System A, System P or XPro?

System A is for lenses between 36 and 62mm in diameter, and is recommended for focal length over 35mm.

For shorter focal lengths, 20-24 or 28mm as well as for wide-angle zooms (24-50mm, 28-85mm, 35-135mm) System P is strongly recommended. It is available in diameters ranging from 48 to 82mm and eliminates vignetting (dark edges).

The X-Pro Series has been specially developed for professionals using medium or large format cameras and the 'extreme' lenses used by broadcasters, videographers and photographers. It is available in diameters ranging from 62mm to 112mm, and will fit lenses with diameters up to 118mm with the Universal Adapter Ring.

- Now that you've decided, screw the adapter ring onto your lens.
  - System "A" rings come in the following diameters: 36/37/39/40.5/41/42/43/43.5/44/46/48/49/52/54/55/58/62mm and Hasselblad special rings.
  - System "P" rings come in the following diameters: 48/49/52/55/58/62/67/72/77/82mm and Hasselblad special rings.
- Slide the filter holder on the adapter ring until it snaps in place. The filter holder is now solidly attached to the lens, yet it can rotate both left and right.
- Slide the filter into one of the filter holder slots. The one closest to the filter holder housing is the narrowest; it allows the use of round filters with notched edges (polarizer, star filters...). The two central slots are intended for square filters. The outer slot can be used either for an additional filter or for a coupling ring.

## CREATIVE FILTER SYSTEM

### X-PRO Series

X-PRO is a versatile system ideally suited to today's wide variety of assignments - portrait, landscape, advertising, editorial and industrial. With a 170mm x 130mm filter size, the X-PRO Series has been specially developed to offer professionals a comprehensive range of filters that can be used on medium and large format cameras, and the 'extreme' lenses required by photographers, videographers and broadcasters. Now in one integrated filter system, X-PRO makes vignetting a problem of the past and removes many of the practical restrictions on creativity.

- ◆ There are over 60 filters to tempt the professional, each made from improved high tech CR-39 organic glass (see box) to ensure excellent optical quality. User flexibility is achieved using Cokin's unique Universal Filter Holder System, creating the capability for a filter to fit many different types and sizes of lens.
- ◆ Adapter rings are available from 62-112mm and will fit diameters up to 118mm with a 4-point universal ring. The X-PRO Adapter Ring System benefits from Cokin's 20 years of experience with the 'A' and 'P' systems.
- ◆ They fit many different types of lens - large diameter zooms, extreme wide-angle lenses, medium and large format, cinema and broadcasting.
- ◆ Made of a lightweight, high-tech material, the holder has an exclusive Ring Locker System. Developed by Cokin, the system ensures that the holder can be secured in a certain position and that the filter is kept parallel to the lens.
- ◆ Furthermore, if the photographer requires the filter to be rotated freely, this can also be achieved with this exclusive system. Another way in which the X-PRO system really considers the professional photographer's needs.

### High-Tech CR-39 Organic Glass

- ◆ Extra lightweight, making the filter system much easier and more comfortable to rotate and maneuver
- ◆ Highly resistant to shocks, meaning that photographers, videographers and cameramen can handle the filters in complete confidence and safety
- ◆ Excellent optical transmission and high compatibility with coloring make Cokin filters the proven choice of photographers worldwide.

For the X-Pro Series, Cokin uses improved CR-39, generating all the optical advantages of CR-39 but on a 3mm thick material that is required for large filter sizes. Despite this thickness, the optical transmission is comparable to the high standard achieved on the Cokin 'P' Series, where the CR-39 is only 1.6mm thick.

### Filter Holders



#### B041 "A" Series Filter Holder (COFHAB40)

With 40 page pamphlet. Requires adapter ring .....5.95

#### B031 "A" System Filter Holder (COBPA)

With 112 page system book. Requires adapter ring .....9.95

#### B081 "P" Series Filter Holder (COFHPB112)

With 112 page system book. Requires adapter ring .....12.95

#### B091 "P" Series - Filter Holder (COFHPB36)

With 36 page pamphlet. Requires adapter ring .....7.95

#### 49mm Introduction Kit A II (COIKA249)

Includes 49mm Adapter Ring, A Series Filter Holder and 36-page Cokin Brochure.....8.50

#### 52mm Introduction Kit A II (COIKA252)

Includes 52mm Adapter Ring, A Series Filter Holder and Cokin Brochure.....8.50

#### 52mm Introduction Kit P II (COIKP252)

Includes 52mm Adapter Ring, P Series Filter Holder and Cokin Brochure .....14.95

#### 52mm Screw-in Filter Kit (COIKA52)

Includes UV Filter (A231) and Circular Polarizer (A164) .....Call

#### 55mm Introduction Kit A II (COIKA255)

Includes 55mm Adapter Ring, A Series Filter Holder and Cokin Brochure.....8.50

#### 58mm Introduction Kit A II (COIKA258)

Includes 58mm Adapter Ring, A Series Filter Holder and Cokin Brochure.....8.50

#### 62mm Introduction Kit A II (COIKA262)

Includes 62mm Adapter Ring, A Series Filter Holder and Cokin Brochure.....8.50

#### 77mm Introduction Kit P II (COIKP277)

Includes 77mm Adapter Ring, P Series Filter Holder and Cokin Brochure .....14.95

**B081 Cokin P Series Filter Holder, 100 Page Book and P249 A/P Adapter (COFHAPA) .....16.50**

#### Wide Angle Filter Holder for Cokin P (COFWAP)

Requires adapter ring .....12.50

#### X-Pro Filter Holder (COFHXP)

Requires adapter ring .....59.95



## CREATIVE FILTER SYSTEM

### Black & White Filters

These intensely colored filters are intended for black-and-white film. They reduce certain colors and accentuate others. In this way, it is possible to enhance or reduce the contrast of certain portions of the subject similar to the use of Polarizers or Graduated filters in color photography.



without filter



with 002 Orange filter

|                  | "A"  | "P"   | "X Pro" |
|------------------|------|-------|---------|
| 001 Yellow       | 9.95 | 12.95 | 41.95   |
| 002 Orange       | 9.95 | 12.95 | 41.95   |
| 003 Red          | 9.95 | 12.95 | 41.95   |
| 004 Green        | 9.95 | 12.95 | 41.95   |
| 006 Yellow Green | 9.95 | 12.95 | 41.95   |

### Blue Filters

Cokin Blue filters comprise two major groups: Color conversion (020, 021, and 022) and Color compensating filters (023, 024, and 025). Color conversion filters (020, 021, and 022) correspond to the Wratten Series 80. They modify artificial light (2800 to 3400 K) for daylight type color film. In addition, they can introduce a deep blue cast to your pictures, thereby adding a touch of mystery.



without filter



with 020 Blue filter

|                | "A"  | "P"   | "X Pro" |
|----------------|------|-------|---------|
| 020 Blue (80A) | 9.95 | 12.95 | 46.50   |
| 021 Blue (80B) | 9.95 | 12.95 | 46.50   |
| 022 Blue (80C) | 9.95 | 12.95 | 46.50   |
| 023 Blue (82A) | 9.95 | 12.95 | 46.50   |
| 024 Blue (82B) | 9.95 | 12.95 | 46.50   |
| 025 Blue (82C) | 9.95 | 12.95 | 46.50   |

### Warm

These filters add warmth to light and a pleasant tan to your photo. In general, they suppress blue casts on overcast days and on subjects lit by blue sky. These filters correspond to the Wratten series 81 (81A, 81B, 81C) and complement the Cokin blue filters (023, 024, and 025) which create cooler or bluer tones.



without filter



with 037 warm (81EF) filter

|                 | "A"  | "P"   | "X Pro" |
|-----------------|------|-------|---------|
| 026 Warm (81A)  | 9.95 | 12.95 | 46.50   |
| 027 Warm (81B)  | 9.95 | 12.95 | 46.50   |
| 028 Warm (81C)  | 9.95 | 12.95 | 46.50   |
| 035 Warm (81D)  | 9.95 | 12.95 | 46.50   |
| 037 Warm (81EF) | 8.50 | 10.95 | 46.50   |

### Orange

Using tungsten film in daylight will produce a bluish cast in the photograph. These filters correspond to the Wratten Series 85. The 85 series will produce natural colors when shooting with tungsten film outdoors. A #85 filter will decrease the color temperature from 5500K to 3400K and produce slightly cooler results than an 85B.



without filter



with 037 warm (81EF) filter

|                  | "A"  | "P"   | "X Pro" |
|------------------|------|-------|---------|
| 029 Orange (85A) | 9.95 | 12.95 | 46.50   |
| 030 Orange (85B) | 9.95 | 12.95 | 46.50   |
| 031 Orange (85C) | 9.95 | 12.95 | 46.50   |

## CREATIVE FILTER SYSTEM

### Sepia

The Sepia filters are for use with color film only. They give your pictures a sepia color very close to that of old fashioned photographs. Available in standard (005) and mild (045) sepia tones. Combine them for deeper effects or for very brightly lit scenes: sea, snow etc.



without filter



with 045 Sepia filter

|           | "A"  | "P"   | "X Pro" |
|-----------|------|-------|---------|
| 005 Sepia | 9.95 | 12.95 | 41.95   |
| 045 Sepia | 9.95 | 12.95 | 44.95   |

### FLD/FLW

FL-D filters correct the greenish tone that appears when shooting daylight film under general purpose fluorescent lighting. FL-W filters balance daylight film under warm white or white type fluorescent lamps



without filter



with 046 FLW filter

|         | "A"  | "P"   | "X Pro" |
|---------|------|-------|---------|
| 036 FLD | 9.95 | 12.95 | 46.50   |
| 046 FLW | 9.95 | 12.95 | 46.50   |

### Gold

The 047 Gold filter adds a distinctive golden tone to the photograph, which is useful in sunset photography or for when you want your photos to take on an antique look. It is also used by some as a Full daylight correction and warming filter in under water photography.



without filter



with 047 Gold filter

|          | "A"  | "P"   | "X Pro" |
|----------|------|-------|---------|
| 047 Gold | 9.95 | 12.95 | —       |

### Cyan

The 050 is a special effects filter used when the photographer wishes to add a distinctive blue tint over the entire image. The distinctive cyan color lends itself to blue sunsets reminiscent of the southern hemisphere, especially the south pacific.



without filter



with 050 Cyan filter

|          | "A"  | "P"   | "X Pro" |
|----------|------|-------|---------|
| 050 Cyan | 9.95 | 12.95 | —       |

### Stars

Add sparkle to night shots, city skylines, street scenes, streetlights, car headlights, candle lights or any place there's sources of points of light. Star filters make the lights come to life like magic. Depending on the properties of the filter, you get points of light surrounded by 2, 4, 8 or 16 rays. The best effect is achieved against a dark background and with a relatively short exposure. The stars can be positioned as desired by turning the filter. The more powerful and point-shaped the source of light is, the more intense and longer the rays of the star. Additionally, they can be used as soft-focus attachments.



without filter



with 055 Star 16 filter



without filter



with 059 Softstar 1 filter

|                | "A"   | "P"   | "X Pro" |
|----------------|-------|-------|---------|
| 055 Star 16    | 13.95 | 17.50 | —       |
| 056 Star 8     | 13.95 | 17.50 | —       |
| 057 Star 4     | 13.95 | 17.50 | —       |
| 058 Star 2     | 10.99 | 17.50 | —       |
| 059 Softstar 1 | 13.95 | 17.50 | —       |



## CREATIVE FILTER SYSTEM

### Center Spot

With a clear spot in the center, Center Spots color or darken the surrounding area, which is often distracting. They allow you to concentrate your attention on your principal subject, or isolate your subject in a group photo. Mainly used for portraits and still-life work, Center Spots also give excellent results with landscapes, architecture and sports. They may be used as colored or neutral diffuser masks when the surroundings do not harmonize with the composition. For lenses between 50 and 250mm.



without filter

with 065 CS Green filter



|                  | "A"   | "P"   |
|------------------|-------|-------|
| 060 CS Incolor 1 | 10.95 | 13.95 |
| 061 CS Incolor   | 10.95 | 13.95 |
| 062 CS Grey 1    | 10.95 | 13.95 |
| 063 CS Grey 2    | 10.95 | 13.95 |
| 064 CS Violet    | 10.95 | 13.95 |
| 065 CS Green     | 10.95 | 13.95 |
| 066 CS Orange    | 10.95 | 13.95 |
| 067 CS Blue      | 10.95 | 13.95 |
| 068 CS Red       | 10.95 | 13.95 |

### Center Spot Wide Angle

Same as above, for 20-40mm wide-angle lenses.



without filter

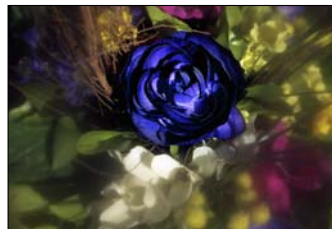

with 072 CS Wide Angle Grey 1 filter

|                             | "A"   | "P"   | "X Pro" |
|-----------------------------|-------|-------|---------|
| 070 CS Wide Angle Incolor 1 | 10.95 | 13.95 | —       |
| 071 CS Wide Angle Incolor 2 | 8.95  | 13.95 | 46.95   |
| 072 CS Wide Angle Grey 1    | 12.50 | 10.99 | —       |
| 073 CS Wide Angle Grey 2    | 12.50 | 14.95 | —       |
| 074 CS Wide Angle Violet    | 12.50 | 13.95 | —       |
| 075 CS Wide Angle Green     | 12.50 | 13.95 | —       |
| 076 CS Wide Angle Orange    | 12.50 | 13.95 | —       |
| 077 CS Wide Angle Blue      | 12.50 | 13.95 | —       |
| 078 CS Wide Angle Red       | 12.50 | 13.95 | —       |

### Color Varnish, Color Vaseline, Color Diffuser

Produce painting like effects by spreading Varnish or Vaseline on the Cokin Basic filter (376). Both the amateur and the devoted art photographer will derive pleasure from these "paints". The 082 Color Diffuser is a set of metallized films of variable colors (cold and warm) to create romantic pastel-like effects.



without filter



with 082 Color Diffuser filter

|                    | "A"   | "P"   | "X Pro" |
|--------------------|-------|-------|---------|
| 080 Color Varnish  | 12.95 | 13.95 | —       |
| 081 Color Vaseline | 13.95 | 13.95 | —       |
| 082 Color Diffuser | 6.95  | 12.50 | —       |

### Diffusers & Pastels

Diffuser filters have very little effect on the sharpness of the image. They merely diffuse highlights, thus reducing contrast. As such, Diffusers can be used to soften a landscape without suppressing detail. They can also soften the skin texture and hide minor flaws. You can take a sharp portrait without emphasizing every pore. Pastel filters can be used to add delicate pastel hues to your subject. All you need is a pleasant subject, a backlit, scene or a simple tree or landscape.



without filter



with 087 Pastel 2 filter

|                            | "A"   | "P"   | "X Pro" |
|----------------------------|-------|-------|---------|
| 083 (830) Diffuser 1       | 12.50 | 14.95 | 64.95   |
| 084 (840) Diffuser 2       | 12.50 | 14.95 | 64.95   |
| 085 (850) Diffuser 3       | 12.50 | 14.95 | 64.95   |
| 086 Pastel 1               | 12.50 | 14.95 | 64.95   |
| 087 Pastel 2               | 12.50 | 14.95 | 64.95   |
| 088 Color Diffuser (Blue)  | 12.50 | 14.95 | 64.95   |
| 089 Color Diffuser (Solid) | 12.50 | 14.95 | 64.95   |

## CREATIVE FILTER SYSTEM

### Dreams

Dream Filters are small circular lenses which create a second image around an unaltered central image. This second image appears more or less as a distinct halo, depending on the focal length, the aperture and the background. Choose between filters depending upon the amount of space that you require for the halo compared to the subject.



without filter



with 092 Dreams 3 filter

|              | "A"   | "p"   | "X Pro" |
|--------------|-------|-------|---------|
| 091 Dreams 1 | 21.95 | 29.95 | —       |
| 092 Dreams 2 | 21.95 | 29.95 | —       |
| 093 Dreams 3 | 21.95 | 29.95 | —       |

### Close-up & Split Field

These filters allow you to take close-up shots covering without blocking any light, so they only alter the reproduction ratio and greatly increase the working range of standard and telephoto lenses. With the split-field close-up lens, you can get a sharp and magnified foreground while maintaining the background in focus. Enhance the mood by contrasting a blurred, lighter subject against a darker area.



without filter



with 112 Split-Field +2 filter

|                    | "A"   | "p"   | "X Pro" |
|--------------------|-------|-------|---------|
| 101 Close up +1    | 12.95 | 17.95 | —       |
| 102 Close up +2    | 10.50 | 15.95 | —       |
| 103 Close up +3    | 12.95 | 17.95 | —       |
| 111 Split-field +1 | 8.95  | 14.95 | —       |
| 112 Split-field +2 | 11.50 | 15.95 | —       |
| 113 Split-field +3 | 11.40 | 17.40 | —       |

### Graduated Filters

Made in a wide range of compound colors that blend harmoniously into the image, these filters permit selective color enhancement or modification without changing the subject. Use them to reduce the excessive brightness range that frequently arises in two parts of the picture, for instance the difference in light between the foreground and the sky in a landscape shot. The filters are also capable of an infinite number of effects. Filters can be combined with each other, either in similar positions or with the densities opposed, to selectively color certain portions of the subject.



without filter

with 122 Graduated Blue B1 filter

|                          | "A"   | "p"   | "X Pro" |
|--------------------------|-------|-------|---------|
| 120 Graduated Grey G1    | 13.95 | 17.95 | 63.50   |
| 121 Graduated Grey G2    | 13.95 | 17.95 | 63.50   |
| 122 Graduated Blue B1    | 13.95 | 17.95 | 63.50   |
| 123 Graduated Blue B2    | 13.95 | 17.95 | 63.50   |
| 124 Graduated Tobacco T1 | 13.95 | 17.95 | 63.50   |
| 125 Graduated Tobacco T2 | 13.95 | 17.95 | 63.50   |
| 126 Graduated Mauve M1   | 13.95 | 17.95 | 63.50   |
| 128 Graduated Pink P1    | 13.95 | 17.95 | 63.50   |
| 129 Graduated Pink P2    | 13.95 | 17.95 | 63.50   |
| 130 Graduated Emerald E1 | 13.95 | 17.95 | 63.50   |
| 131 Graduated Emerald E2 | 13.95 | 17.95 | 63.50   |
| 132 Graduated Yellow Y1  | 13.95 | 17.95 | 63.50   |
| 133 Graduated Yellow Y2  | 13.95 | 17.95 | 63.50   |
| 138 Graduated FLW        | 13.95 | 17.95 | 63.50   |
| 139 Graduated FLD        | 13.95 | 17.95 | 63.50   |

### Oval Center Spot

A Center Spot filter with an oval instead of a circle in the middle. Suitable for all focal lengths. Ideal for horizontal or group portraits.



without filter



with 141 Oval Center Spot Black filter

|                            | "A"   | "p"   | "X Pro" |
|----------------------------|-------|-------|---------|
| 140 Oval Center Spot White | 10.50 | 12.50 | 49.95   |
| 141 Oval Center Spot Black | 10.50 | 12.50 | 49.95   |



## CREATIVE FILTER SYSTEM

### Net Filter

Black Net filters soften fine details with no change in contrast, while the White Net filters soften details and also lower contrast.



without filter



with 143 Net #1 Black filter

|                  | "A"  | "P"   | "X Pro" |
|------------------|------|-------|---------|
| 142 Net #1 White | 8.95 | 12.95 | 33.95   |
| 143 Net #1 Black | 8.95 | 12.95 | 33.95   |
| 144 Net #2 White | 8.95 | 12.95 | 33.95   |
| 145 Net #2 Black | 8.95 | 12.95 | 33.95   |

### Wedding

A neutral filter that produces a diffused area along a sharp curve Softens area around subject Ideal for portraits



without filter



with 148 Wedding 1 filter

|                     | "A"  | "P"   | "X Pro" |
|---------------------|------|-------|---------|
| 148 Wedding 1 White | 9.95 | 12.95 | —       |
| 149 Wedding 1 Black | 9.95 | 12.95 | —       |

### Fog

Add a touch of dream and mystery to your photos. These filters are available in two different densities and have a misty graduated area.



without filter



with 151 Fog 2 filter

|           | "A"   | "P"   | "X Pro" |
|-----------|-------|-------|---------|
| 150 Fog 1 | 13.95 | 17.95 | —       |
| 151 Fog 2 | 13.95 | 17.95 | —       |

### Neutral Density (ND)

For use in bright light. ND filters allow you to gain the 1, 2, or 3 apertures you need to allow you to play with back-grounds, distance and depth-of-field. ND filters allow you to use the low speeds you need to give an impression of motion.



without filter



with 154 Grey NDx8 filter

|               | "A"  | "P"   | "X Pro" |
|---------------|------|-------|---------|
| 152 Grey NDx2 | 9.95 | 12.95 | 46.50   |
| 153 Grey NDx4 | 9.95 | 12.95 | 46.50   |
| 154 Grey NDx8 | 9.95 | 12.95 | 46.50   |

### Polarizers

Polarizers are most useful for increasing general outdoor color saturation and contrast. They also eliminate reflected glare making them ideal when shooting water (lakes, ponds) or window glass. The Color Polarizers allow you to take polarized pictures with color.



without filter



with 165 Redhancer filter

|                        | "A"   | "P"   | "X Pro" |
|------------------------|-------|-------|---------|
| 160 Linear Polarizer   | 21.95 | 31.95 | 149.95  |
| 161 Polacolor Red      | 21.95 | 31.95 | 149.95  |
| 162 Polacolor Blue     | 21.95 | 31.95 | 149.95  |
| 163 Polacolor Yellow   | 21.95 | 31.95 | 149.95  |
| 164 Circular Polarizer | 29.95 | 56.95 | 259.95  |
| 165 Redhancer          | 29.95 | 56.95 | 259.95  |

### Varicolor

Use Varicolor filters to produce truly bizarre effects. Each Varicolor filter gives a dominant tone, which you can use to the picture you have chosen. Rotate the filter for unusual shades which will enhance reality.



without filter



with 170 Red/Green filter

|                 | "A"   | "P"   |
|-----------------|-------|-------|
| 170 Red/Green   | 21.95 | 33.95 |
| 171 Red/Blue    | 21.95 | 33.95 |
| 172 Pink/Orange | 21.95 | 33.95 |
| 173 Blue/Yellow | 21.95 | 33.95 |
| 174 Blue/Lime   | 21.95 | 28.95 |



## CREATIVE FILTER SYSTEM

### Radial Zoom, Rainspot, Sunspot

The Radial Zoom gives the effect of zooming a telephoto lens during exposure. Rainspot is a clear center spot diffusion filter that surrounds the subject with the impression of a heavy rain. Softspot is like a Diffuser with a clear center spot.



without filter



with 185 Radial Zoom filter

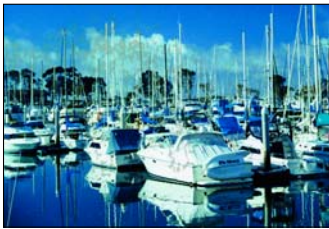

without filter



with 186 Rainspot filter

|                 | "A"   | "P"   | "X Pro" |
|-----------------|-------|-------|---------|
| 185 Radial Zoom | 10.95 | 14.95 | —       |
| 186 Rainspot    | 10.95 | 14.95 | —       |
| 188 Softspot    | 10.95 | 14.95 | —       |
| 189 Sunspot     | 10.95 | 14.95 | —       |

### Rainbow & Sunset

With a Rainbow or Sunset filter you don't have wait for a rain or evening - you can simulate a rainbow or the colors of the setting sun at almost anytime.



without filter



with 196 Rainbow 2 filter

|               | "A"   | "P"   | "X Pro" |
|---------------|-------|-------|---------|
| 195 Rainbow 1 | 14.95 | 17.95 | —       |
| 196 Rainbow 2 | 14.95 | 17.95 | —       |
| 197 Sunset 1  | 14.95 | 19.95 | 69.95   |
| 198 Sunset 2  | 14.95 | 19.95 | 69.95   |

### Multi-Image

Cokin's Multi-image filters let you create more than just repeat images. Because the filter holder is fully adjustable both axially and laterally, they give you much more control. The 209 Multi-parallel attachment creates parallel multiple images.



without filter



with 203 Multi-image X13 filter

|                      | "A"   | "P"   |
|----------------------|-------|-------|
| 201 Multi-image X 5  | 21.95 | 27.95 |
| 202 Multi-image X 7  | 21.95 | 27.95 |
| 203 Multi-image X 13 | 21.95 | 27.95 |
| 204 Multi-image X 25 | 21.95 | 27.95 |
| 209 Multi-parallel   | 24.95 | 32.95 |

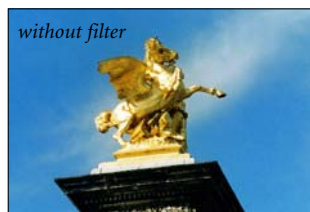

without filter



with 217 Super Speed filter

### Speed & Mirage

The Speed filter adds streaks of lights to give the impression that something is rushing by. The Super Speed filter speeds things up, making the world move, giving life to inanimate objects. The Mirage filter will allow you to photograph an ordinary scene and make it appear as if it is being reflected on a large lake.

|                 | "A"   | "P"   |
|-----------------|-------|-------|
| 216 Speed       | 24.95 | 29.95 |
| 217 Super Speed | 25.95 | 32.95 |
| 220 Mirage      | 26.95 | —     |

### UV & Skylight

These filters eliminate the blue casts that your photos pick up from U.V. rays and clarify misty views.

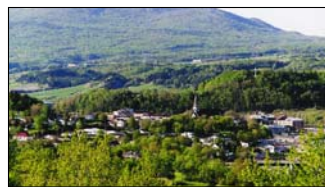

without filter

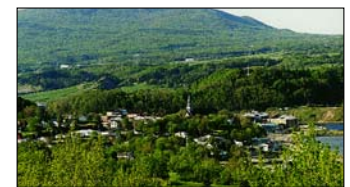

with 231 UV filter

|                    | "A"  | "P"   | "X Pro" |
|--------------------|------|-------|---------|
| 230 UV Sky Neutral | 9.95 | 12.95 | —       |
| 231 UV             | 9.95 | 12.95 | —       |
| 232 Skylight 1B    | 9.95 | 12.95 | —       |

## CREATIVE FILTER SYSTEM

### Mask & Double Exposure

With this ingenious Mask filter kit, you can create a photomontage, while with the Double Mask system you can combine two scenes in one, creating a photomontage in your camera. The Double Mask #345 has a larger center spot. The Double Exposure filter allows you to expose each half of one piece of film separately.



without filter

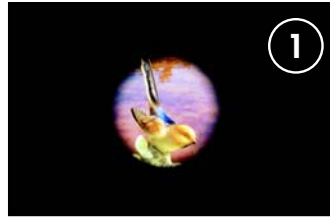

with 342 Double Mask 1 filter



|                     | "A"   | "P"   | "X Pro" |
|---------------------|-------|-------|---------|
| 340 Creative Mask   | 13.95 | 21.95 | —       |
| 342 Double Mask 1   | 14.95 | 17.95 | —       |
| 345 Double Mask 2   | 14.95 | 17.95 | —       |
| 346 Double Exposure | 9.95  | 9.95  | —       |

### Creative, Basic & Pre-shaped

The Creative filter consists of a gelatin holder and ten acetate filters of corresponding size. The Basic Filter is a clear filter used in conjunction with other special effects tools, such as the Color Varnish (#080) and Color Vaseline (#081) filters. The Basic filter serves as a palette onto which these other liquids are applied. The Pre-shaped set contains a slide-in sandwiching mount which fits into the holder. The slide-in mount accepts any of the included 10 pre-shaped black masks.



without filter



with 097 Pre-shaped filter

|                | "A"   | "P"   | "X Pro" |
|----------------|-------|-------|---------|
| 375 Creative   | 23.95 | 31.95 | —       |
| 376 Basic      | 13.95 | 17.95 | —       |
| 397 Pre-shaped | 16.95 | 21.95 | —       |

### Graduated Fluorescent

Cokin fluorescent filters have a more luminous color effect than standard Cokin color graduated filters and can be used as effects filters. Precisely controllable color moods, which formerly were rarely seen outside of pop videos, are easy to achieve with these filters.



without filter



with 670 Gradual Fluo Pink 1 filter

|                           | "A"   | "P"   |
|---------------------------|-------|-------|
| 660 Gradual Fluo Yellow 1 | 12.95 | 16.95 |
| 661 Gradual Fluo Yellow 2 | 12.95 | 16.95 |
| 662 Gradual Fluo Orange 1 | 12.95 | 16.95 |
| 663 Gradual Fluo Orange 2 | 12.95 | 16.95 |
| 664 Gradual Fluo Red 1    | 12.95 | 16.95 |
| 665 Gradual Fluo Red 2    | 12.95 | 16.95 |
| 666 Gradual Fluo Blue 1   | 12.95 | 16.95 |
| 667 Gradual Fluo Blue 2   | 12.95 | 16.95 |
| 668 Gradual Fluo Mauve 1  | 12.95 | 16.95 |
| 669 Gradual Fluo Mauve 2  | 12.95 | 16.95 |
| 670 Gradual Fluo Pink 1   | 12.95 | 16.95 |
| 671 Gradual Fluo Pink 2   | 12.95 | 16.95 |

### Bi-Color Center Spot

Bi-Color Center Spot filters are used in exactly the same way as other Center Spot filters. These filters have a clear spot in the center and create a two-color diffusion (pink/blue, yellow/pink or blue/yellow) around the main subject, which is not modified.



without filter



with 674 Blue/Yellow filter

|                 | "A"   | "P"   | "X Pro" |
|-----------------|-------|-------|---------|
| 672 Pink/Blue   | 12.95 | 16.95 | —       |
| 673 Yellow/Pink | 12.95 | 16.95 | —       |
| 674 Blue/Yellow | 12.95 | 16.95 | —       |



## CREATIVE FILTER SYSTEM

### Sunsoft, Champagne, Softwarm, Diffuser

The Sunsoft filter is similar to the Softwarm except that the Sunsoft has a warmer tone. As such, it is also good for portraiture or any scenario where the photographer wishes to add additional warmth and diffusion to the image. Champagne is a slightly orange filter with a more orange center spot. The Diffuser not only diffuses highlights but adds a slight warmth to the image.



without filter

with 695 Champagne filter

|               | "A"   | "P"   | "X Pro" |
|---------------|-------|-------|---------|
| 694 Sunsoft   | 8.95  | 13.95 | 64.95   |
| 695 Champagne | 16.95 | 11.50 | —       |
| 696 Softwarm  | 13.50 | 14.95 | 64.95   |
| 697 Diffuser  | 14.95 | 18.95 | —       |

### Color Correction (X-Pro Only)

Some photographic situations require specific color corrections. For example, when shooting daylight film under fluorescent lighting, some magenta correction is needed in order to remove the greenish tint that would otherwise appear. The amount of color correction required is most accurately measured via a color temperature meter. Cokin Color Compensating filters are made of plastic and are available in Magenta and Yellow colors.

|                    |                                  |            |
|--------------------|----------------------------------|------------|
| 710 CC05M Magenta: | 0.05 density compensating filter | .....97.50 |
| 711 CC10M Magenta: | 0.10 density compensating filter | .....97.50 |
| 713 CC20M Magenta: | 0.20 density compensating filter | .....97.50 |
| 715 CC30M Magenta: | 0.30 density compensating filter | .....97.50 |
| 717 CC40M Magenta: | 0.40 density compensating filter | .....97.50 |
| 719 CC50M Magenta: | 0.50 density compensating filter | .....97.50 |
| 720 CC05Y Yellow:  | 0.05 density compensating filter | .....97.50 |
| 721 CC10Y Yellow:  | 0.10 density compensating filter | .....97.50 |
| 723 CC20Y Yellow:  | 0.20 density compensating filter | .....97.50 |
| 725 CC30Y Yellow:  | 0.30 density compensating filter | .....97.50 |
| 727 CC40Y Yellow:  | 0.40 density compensating filter | .....97.50 |
| 729 CC50Y Yellow:  | 0.50 density compensating filter | .....97.50 |

### FILTER KITS & ACCESSORIES

|   | "A"                     | "P"                     |
|---|-------------------------|-------------------------|
| <b>117 Creative Kit:</b> Includes A or P Series filter holder, 8-Point Star Effect (056), Graduated B2 Blue Filter (123) and Diffuser 1 (083/830) filters                   | #COSKA<br><b>49.95</b>  | #COSKP<br><b>71.95</b>  |
| <b>200 Portrait 1 Filter Kit:</b> Includes A or P Series filter holder, 81B Color Conversion (027), Incolor 2 Wide-Angle Center Spot (071) and Diffuser 2 (084/840) filters | #COPIKA<br><b>29.95</b> | #COH200<br><b>37.50</b> |
| <b>201 Portrait 2 Filter Kit:</b> Includes A or P Series filter holder, 81D Warming (035), Net #1 White (142) and Blue/Yellow Bi-Color Center Spot (674) filters            | #COP2KA<br><b>29.95</b> | #COH201<br><b>34.50</b> |
| <b>210 Landscape 1 Filter Kit:</b> Includes A or P Series filter holder, 81EF Warming (037), Gradual Blue B2 Soft (123s) and Sunset 1 (197) filters                         | #COLIKA<br><b>34.50</b> | #COH210<br><b>44.95</b> |
| <b>211 Landscape 2 Filter Kit:</b> Includes A or P Series filter holder, Gold Special Color Effect (047), 8-Point Star Effect (A056) and Gradual Tobacco T2 Soft            | #COG211<br><b>32.95</b> | #COH211<br><b>47.95</b> |
| <b>220 Black and White Filter Kit:</b> Includes A or P Series filter holder, Yellow (001), Red (003) and Green (004) filters  | #COG220<br><b>23.95</b> | #COH220<br><b>34.50</b> |
| <b>230 Wedding Kit:</b> Includes A or P Series filter holder, Warm 81EF (037), Diffuser 2 (084) and Champagne (695) filters   | #COWKA<br><b>19.95</b>  | #COH230<br><b>37.50</b> |
| <b>240 Soft Filter Kit:</b> Includes A or P Series Filter holder, Diffuser Light (820), Diffuser 1 (083/830) and Diffuser 2 (084/840) filters                               | #COG240<br><b>32.95</b> | #COH240<br><b>44.95</b> |

#### X-Pro W950 Pro Basic Filter Kit 1:

Includes X-Pro Filter Holder, Linear Polarizer (X160) and Gradual Grey G2 Medium Filter (X121M)  
#COW950 .....**224.95**

#### X-Pro W951 Pro Basic Filter Kit 2:

Includes X-Pro Filter Holder, Gradual Grey G2 Medium (X121M) and Circular Polarizer (X164)  
#COW951 .....**337.50**

#### X-Pro W960 Pro Graduated Neutral Density Filter Kit:

Includes X-Pro Filter Holder, Gradual Grey G2 Light Filter (X121L), Gradual Gray G2 Medium Filter (X121M) and Gradual Gray G2 Light Filter (X121S) #COW960..... **187.50**

#### X-Pro W961 Pro Graduated Filter Kit:

Includes X-Pro Filter Holder, Gradual Grey G2 Light Filter (X121L), Gradual Blue B2 Light Filter (X123L) and Gradual Tobacco T2 Light Filter (X125L) #COW961 .....**187.50**

## CREATIVE FILTER SYSTEM

### "A" Series Adapter Rings

|   |              |
|---|--------------|
| <b>36mm Adapter Ring (A601)</b><br>#COARA36.....                    | <b>6.95</b>  |
| <b>46mm Adapter Ring (A609)</b><br>#COARA46.....                    | <b>6.95</b>  |
| <b>48mm Adapter Ring (A256)</b><br>#COARA48.....                    | <b>6.95</b>  |
| <b>49mm Adapter Ring (A257)</b><br>#COARA49.....                    | <b>4.50</b>  |
| <b>52mm Adapter Ring (A258)</b><br>#COARA52.....                    | <b>4.50</b>  |
| <b>54mm Adapter Ring (A610)</b><br>#COARA54.....                    | <b>6.95</b>  |
| <b>55mm Adapter Ring (A259)</b><br>#COARA55.....                    | <b>4.50</b>  |
| <b>58mm Adapter Ring (A260)</b><br>#COARA58.....                    | <b>4.50</b>  |
| <b>62mm Adapter Ring (A261)</b><br>#COARA62.....                    | <b>6.95</b>  |
| <b>Adapter Ring (A263) for Canon FD 35-70mm</b><br>#COARAC3570..... | <b>8.95</b>  |
| <b>Bay 50 Adapter Ring (A262) for Hasselblad</b><br>#COARAB50.....  | <b>24.95</b> |



Bay 60 Adapter Ring



55mm Adapter Ring

### "P" Series Adapter Rings

|   |              |
|---|--------------|
| <b>48mm Adapter Ring (P448) (COARP48)</b> .....                 | <b>14.95</b> |
| <b>49mm Adapter Ring (P449) (COARP49)</b> .....                 | <b>9.15</b>  |
| <b>52mm Adapter Ring (P452) (COARP52)</b> .....                 | <b>9.15</b>  |
| <b>55mm Adapter Ring (P455) (COARP55)</b> .....                 | <b>9.15</b>  |
| <b>58mm Adapter Ring (P458) (COARP58)</b> .....                 | <b>9.15</b>  |
| <b>62mm Adapter Ring (P462) (COARP62)</b> .....                 | <b>9.15</b>  |
| <b>67mm Adapter Ring (P467) (COARP67)</b> .....                 | <b>9.15</b>  |
| <b>72mm Adapter Ring (P472) (COARP72)</b> .....                 | <b>9.15</b>  |
| <b>77mm Adapter Ring (P477) (COARP77)</b> .....                 | <b>9.15</b>  |
| <b>82mm Adapter Ring (P482) (COARP82)</b> .....                 | <b>9.15</b>  |
| <b>Bay 50 Adapter Ring (P483) for Hasselblad (COARPB50)</b> ... | <b>29.50</b> |
| <b>Bay 6 Adapter Ring (P485) for Rollei (COARPB6)</b> .....     | <b>29.50</b> |
| <b>Bay 60 Adapter Ring (P484) for Hasselblad (COARPB60)</b> ... | <b>29.50</b> |
| <b>Bay 70 Adapter Ring for Hasselblad (COARPB70)</b> .....      | <b>34.95</b> |
| <b>Universal Adapter Ring (P486) (COARPU)</b> .....             | <b>22.50</b> |

### Extension Rings

|   |             |
|---|-------------|
| <b>37mm Extension Ring for A Series Filters (COERA37)</b> ..... | <b>4.95</b> |
| <b>43mm Extension Ring for A Series Filters (COERA43)</b> ..... | <b>4.95</b> |
| <b>67mm Extension Ring for A Series Filters (COERA67)</b> ..... | <b>5.95</b> |
| <b>39mm A Series Adapter Ring (A602) (COARA39)</b> .....        | <b>9.95</b> |
| <b>40.5FD Adapter Ring (A603) (COARA405)</b> .....              | <b>5.50</b> |
| <b>37FD Adapter Ring (A637) (COARA37)</b> .....                 | <b>5.50</b> |
| <b>Extension Ring - 46mm (A312) (COERA46)</b> .....             | <b>6.50</b> |
| <b>Extension Ring - 48mm (A313) (COERA48)</b> .....             | <b>6.50</b> |
| <b>Extension Ring - 49mm (A314) (COERA49)</b> .....             | <b>6.95</b> |
| <b>Extension Ring - 52mm (A315) (COERA52)</b> .....             | <b>6.95</b> |
| <b>Extension Ring - 55mm (A316) (COERA55)</b> .....             | <b>7.95</b> |
| <b>Extension Ring - 58mm (A317) (COERA58)</b> .....             | <b>7.95</b> |



67mm Extension Ring for A Series Filters

### X-Pro Adapter Rings

|  |              |
|--|--------------|
| <b>X-Pro 105mm Adapter Ring (COARXP105)</b> .....                  | <b>46.50</b> |
| <b>X-Pro 112mm Adapter Ring (COARXP112)</b> .....                  | <b>52.95</b> |
| <b>X-Pro 112mm Adapter Ring (COARXP112B)</b> .....                 | <b>55.95</b> |
| <b>X-Pro 112mm Adapter Ring (COARXP112C)</b> .....                 | <b>55.95</b> |
| <b>X-Pro 62mm Adapter Ring (COARXP62)</b> .....                    | <b>46.50</b> |
| <b>X-Pro 67mm Adapter Ring (COARXP67)</b> .....                    | <b>46.50</b> |
| <b>X-Pro 72mm Adapter Ring (COARXP72)</b> .....                    | <b>46.50</b> |
| <b>X-Pro 77mm Adapter Ring (COARXP77)</b> .....                    | <b>46.50</b> |
| <b>X-Pro 82mm Adapter Ring (COARXP82)</b> .....                    | <b>46.50</b> |
| <b>X-Pro 86mm (x .75mm Thread) Adapter Ring (COARXP86A)</b> .....  | <b>46.50</b> |
| <b>X-Pro 86mm (x 1mm Thread) Adapter Ring (COARXP86B)</b> .....    | <b>46.50</b> |
| <b>X-Pro 95mm Adapter Ring (COARXP95)</b> .....                    | <b>46.50</b> |
| <b>X-Pro Adapter Ring for Rollei (COARXPR)</b> .....               | <b>63.50</b> |
| <b>X-Pro Bay 60 Adapter Ring for Hasselblad (COARXPB60)</b> .....  | <b>52.95</b> |
| <b>X-Pro Bay 60 Adapter Ring for Hasselblad (COARXPHB60)</b> ..... | <b>63.50</b> |
| <b>X-Pro Bay 70 Adapter Ring for Hasselblad (COARXPB70)</b> .....  | <b>63.50</b> |
| <b>X-Pro Bay 70 Adapter Ring for Hasselblad (COARXPHB70)</b> ..... | <b>63.50</b> |
| <b>X-Pro Bay VI Adapter Ring for Rollei (COARXPRZ)</b> .....       | <b>52.95</b> |
| <b>X-Pro Universal Adapter Ring (COARXPU)</b> .....                | <b>54.95</b> |

## CREATIVE FILTER SYSTEM

### Cokin "A" Series Filter to "P" Series Holder Adapter (P249)

Allows you to use "A" series filters in a "P" series holder.  
COAPA.....**9.95**

### "A" Series Gelatin Filter Holder (A194)

This holder provides a practical way to combine gelatine filters with the Cokin filter holder system. It is a good idea to have a separate holder for each gelatine filter. The "A" Series Gel holder accepts "trimmed" 3" gels.  
COA194.....**7.95**

### "P" Series Gelatin Filter Holder (P194)

This holder provides a practical way to combine gelatine filters with the Cokin filter holder system. It is a good idea to have a separate holder for each gelatine filter. The "P" Series Gel holder accepts 3" gels.  
COP194.....**8.95**

### A305 Storage Box

Holds 10 "A" Series Filters.  
COSBA.....**9.95**

### Adapter Cap "A" (A253)

This cap is specific to The Cokin "A" series adapter rings. If you leave Cokin "A" series adapter rings on your lenses, it will allow you to cover them while the holder is off.  
COACA.....**3.95**

### Adapter Cap "P" (P253)

This cap is specific to The Cokin "P" series adapter rings. If you leave Cokin "P" series adapter rings on your lenses, it will allow you to cover them while the holder is off.  
COACP.....**5.95**

### Cokin Creative Filter System Book

This comprehensive 112-page book describes the Cokin system. Discusses filter holders, filters, adapter rings and accessories. Illustrated with examples of Cokin system filters.  
COB.....**6.49**

### Cokin "A" Series Lens Cap (A252)

Fits in an "A" series holder and slides in like a filter.  
COFHCA.....**3.95**

### Cokin "P" Series Lens Cap (P252)

Fits in an "P" series holder and slides in like a filter.  
COFHCP.....**5.95**

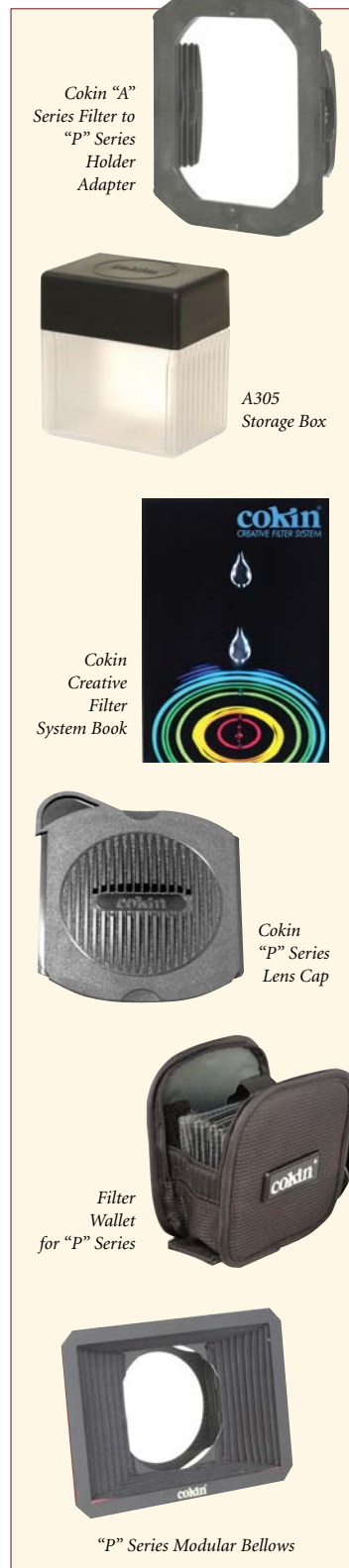

### Coupling Ring and Filter Holder for "A" Series (A308)

This adapter allows you to mount two "A" series holders together. It increases the number of filters you can use or enables the setting of two graduated filters at different angles. (Not for use with wide angle lenses.)  
COCRA.....**15.95**

### Coupling Ring and Filter Holder for "P" Series (P308)

This adapter allows you to mount two "P" series holders together. It increases the number of filters you can use or enables the setting of two graduated filters at different angles. (Not for use with wide angle lenses.)  
COCR.....**23.95**

### Filter Wallet for "A" Series (A306)

Double-zippered Cordura pouch with seven pockets for "A" series filters. Features Cokin logo and Velcro interior.  
COA306.....**14.50**

### Filter Wallet for "P" Series (P306)

Double-zippered Cordura pouch with seven pockets for "P" series filters. Features Cokin logo and Velcro interior.  
COP306.....**15.95**

### Filter Wallet for "X" Series (X306)

Double-zippered Cordura pouch with seven pockets for "X" series filters. Features Cokin logo and Velcro interior.  
COX306.....**24.50**

### Modular Bellows Hood with Filter Holder for X-Pro

The Cokin Modular Bellows is a unique, flexible and self-supporting lens shade which can fit almost any camera available thanks to a simple Cokin Adapter Ring. The bellows provides excellent control over the ambient light conditions, and cuts the glare out for clean and sharp images. An integrated filter-holder is solidly fixed at the rear end of the bellows. Fits lenses from 62 - 118mm, requires adapter ring.  
COMBFHXP.....**184.95**

### Modular Hood for "A" Series Filter Holder (A255)

This plastic hood acts as a lens shade and clips directly on to the "A" filter holder. It is possible to stack multiple hoods to create a longer lens shade for telephoto lenses.  
COMHA.....**7.95**

### Modular Hood for "P" Series Filter Holder (P255)

This plastic hood acts as a lens shade and clips directly on to the "P" filter holder. It is possible to stack multiple hoods to create a longer lens shade for telephoto lenses.  
COMHP.....**9.95**

### "P" Series Modular Bellows (P350)

Modular bellows lens hood with integrated filter holder. Fits lenses from 48-82mm, requires adapter ring  
COP350.....**124.95**



# HELIOPAN

## GENERAL FILTERS

FILTERS

358

Heliopan glass filters are made exclusively with glass from Schott (Zeiss) the world's finest optical glass supplier. "Dyed in the mass" and ground, polished and coated to the highest standards of the German optical industry, all Heliopan screw-in type and series size filters are mounted in precision black anodized brass rings to eliminate binding or cross threading and to ensure optimal alignment. The care, quality and performance of Heliopan's filters make them simply the world's finest filters!

Besides the usual range of filters, Heliopan supplies many different types of polarizers, Zeiss Softars and a full range of special effect filters. All filters that will benefit from coatings are hard coated on both sides, 16 layer multi coatings (SH-PMC) are also available on many Heliopan filters.

Slim mounts for use on wide angle lenses without vignetting is standard on the most common sizes and types. The slim mounts are made of black anodized brass stock and have so little rim in front of the lens (5.4 mm) that they will not vignette with lens as short as 21mm. Yet even though they are so slim, they still retain front threads for a lens cap, a lens hood or even stacking a second filter!



### SH-PMC Multicoating

Reflection on glass to air surfaces is one of the major causes of contrast loss in lenses, which under extreme conditions, make quality photography impossible. The quality inherent in the lens should not be reduced by using filters with inferior coatings. Heliopan's SH-PMC filters are coated with 8 layers on each side. This not only reduces the reflections in the visible areas of the spectrum to almost 0% but it also repels moisture and dust. Consequently the coating provides the greatest protection against damage to the filter and is easier to clean than the lens itself.

### UV Filter EV 0x, LV - 0.0

The UV filter, also known as a haze filter, is not only an excellent universal filter for visually improving photographs with all types of films, it can always stay on the lens for protection from dust, fingerprints, moisture, etc. and for use under extreme conditions. It absorbs the short wave portion of the spectrum so under hazy conditions a clearer reproduction of the scene is possible. The loss of sharpness caused by UV rays and the bluish tones common in infinity scenes are eliminated with the colorless UV filter.

### Neutral Density (ND) Filters

Neutral density filters are a useful tool for controlled light reduction. They permit less depth of field under bright light, since the aperture has to be opened. Or one can eliminate changing film types if a high speed film is used. In addition, long time exposures are possible by using strong ND filters in sun light. ND filters are manufactured from color neutral Schott glass and therefore can be used for B&W and color photography. They are available in 3 densities:

**ND 0.3:** A light gray filter with minimum light absorbtion.

**ND 0.6:** A medium gray filter used for portraits and out-of-focus backgrounds.

**ND 0.9:** A dark gray filter that increases the effect of the medium gray.

| Density | Light Loss | Filter Factor | Exposure Correction |
|---------|------------|---------------|---------------------|
| ND 0.3  | 50%        | 2x            | -1                  |
| ND 0.6  | 25%        | 4x            | -2                  |
| ND 0.9  | 12.5%      | 8x            | -3                  |

### Graduated Neutral Density Filters

Often it is necessary or desirable to balance the light intensity in one part of a scene with another. This is especially true in situations where you don't have total light control, as in bright contrasty landscapes. Exposing for the foreground will produce a washed-out, over-exposed sky while exposing for the sky will leave the foreground dark and under-exposed. Grad ND filters are part clear, part neutral density and are available in grades of .3 (1-stop) or .6 (2-stops). They allow the transition to be blended into the scene, often imperceptibly. A Graduated ND .6 with a two stop differential will generally compensate the average bright sky-to-foreground situation and is also the most popular density of the series.

**Graduated ND factors:** **Graduated ND.3:** (exposure factor = 2x; exposure adjustment = 1 stop; reduces ISO 1/2)

**Graduated ND.6:** (exposure factor = 4x; exposure adjustment = 2 stops; reduces ISO 1/4)



EQUIPMENT LEASING AVAILABLE

## B&W FILTERS

### Light Yellow (5) EV

Slightly reduces blue and is suitable for all outdoor exposures. Slightly darkens blue sky. White clouds become more visible. Snow scenes are more brilliant. Filter factor is approximately 1.5 to 2x.

### Medium Yellow (8)

The standard filter for black & white. It reduces blue more than light yellow. With this filter and the use of panchromatic negative material one produces gray values closer to the actual scene being photographed. Enhances reproduction of clouds in landscapes and is great for contrast improvement with a low sun. Filter factor is approximately 2.5 to 3X

### Yellow Green (11)

Moderately reduces blue tones, reduces reds and lightens green tones. Good filter choice for spring/summer landscapes with a lot of foreground. Corrects the tonal value for reproduction of individual colors on panchromatic material with artificial light. Filter factor is 2x.

### Green (13)

More effective than the yellow green (#11). Reduces blue and red. Especially useful for portrait and still life photography. Considerably lightens green shades for outdoor exposures and is ideal for landscapes. Filter factor is approximately 3x.

### Dark Yellow (15)

Very strong blue reduction. Primarily used in landscape photography with bright sun and deep shadows. It greatly enhances cloud reproduction and increases the depth of field. Filter factor is 4x.

### Orange (22)

Absorbs blue almost completely as well as some green. Creates dramatic enhancement of clouds and reduces atmospheric haze. Especially useful at infinity with telephoto lenses. In portrait and figure photography it smoothes uneven skin tones and wrinkles, hides blemishes. Best portrait results are achieved with green lipstick. Filter factor is 4x

### Light Red (25)

The ideal all around filter for the black & white photographer to create very strong contrast in blue sky and clouds, since it completely absorbs green and blue. Clouds are dramatically improved almost to the mood of a thunderstorm. It is more effective in cutting through haze, and moon light effects are easily achieved. Also suited for infrared photography. Filter factor is approximately 8x.

### UV HAZE, ND and B&W FILTERS

| Filter Size (mm)          | 30.5  | 37    | 39    | 40.5  | 46     | 48     | 49     | 52     | 55     | 58      |
|---------------------------|-------|-------|-------|-------|--------|--------|--------|--------|--------|---------|
| UV Haze #HEUV()           | 20.80 | 21.50 | 27.50 | 27.95 | 23.95  | 27.95  | 23.95  | 24.50  | 27.50  | 28.50   |
| UV Haze SH-PMC #HEUVSMC() | —     | 39.95 | 44.95 | —     | 44.95  | —      | 44.95  | 47.95  | 49.95  | 54.50   |
| ND #HEND()()              | 20.80 | 21.50 | 27.50 | 27.95 | 23.95  | 27.95  | 23.95  | 24.50  | 27.50  | 28.50   |
| Graduated ND #HEGND()()   | —     | —     | —     | —     | —      | —      | 57.95  | 57.95  | 62.50  | 66.95   |
| Color Filters #HE()()     | 20.80 | 21.50 | 27.50 | 27.95 | 23.95  | 27.95  | 23.95  | 24.50  | 27.50  | 28.50   |
| Filter Size (mm)          | 60    | 62    | 67    | 69    | 72     | 77     | 82     | 86     | 95     | 105     |
| UV Haze #HEUV()           | 37.50 | 37.50 | 42.95 | 61.75 | 52.75  | 61.75  | 81.95  | 101.95 | 144.50 | 169.95  |
| UV Haze SH-PMC #HEUVSMC() | —     | 59.95 | 71.50 | 99.95 | 89.95  | 99.95  | 126.95 | 138.50 | 186.50 | —       |
| ND #HEND()()              | 37.50 | 37.50 | 42.95 | 61.75 | 52.75  | 61.75  | 81.95  | 101.95 | 144.50 | 169.95  |
| Graduated ND #HEGND()()   | —     | 69.95 | 77.50 | —     | 86.95  | 104.95 | —      | —      | —      | —       |
| Color Filters #HE()()     | 37.50 | 37.50 | 42.95 | 61.75 | 52.75  | 61.75  | 81.95  | 101.95 | 144.50 | 169.95  |
| Filter Size (mm)          | Bay 1 | Bay 2 | Bay 3 | Bay 4 | Bay 6  | Bay 8  | Bay 50 | Bay 60 | Bay 70 | Bay 104 |
| UV Haze #HEUV()           | —     | —     | 54.95 | —     | 138.95 | —      | 93.95  | 113.50 | —      | —       |
| UV Haze SH-PMC #HEUVSMC() | —     | —     | —     | —     | —      | —      | —      | —      | —      | —       |
| ND #HEND()()              | —     | —     | 54.95 | —     | 138.95 | —      | 93.95  | 113.50 | —      | —       |
| Graduated ND #HEGND()()   | —     | —     | —     | —     | —      | —      | —      | 145.95 | —      | —       |
| Color Filters #HE()()     | —     | —     | 54.95 | —     | 138.95 | —      | 93.95  | 113.50 | —      | —       |

For color filters insert the color code in the first parenthesis, then the filter size in the second parenthesis. For Light Yellow insert (5), Medium Yellow (8), Yellow Green (11), Green (13), Dark Yellow (15), Orange (22) and Light Red (25). So for example, a 52mm Light Red would be HE2552.

For ND filters insert the ND strength (.3, .6 or .9) in the first parenthesis and then the filter size in the second parenthesis. Graduated ND filters are only available in .3 or .6. For example a 67mm ND 0.9 would be HEND.967, while a 58mm Graduated ND 0.6 would be HEGND.658



# HELIOPAN

## POLARIZER FILTERS

FILTERS

360

Polarizing filters are color neutral and increase picture taking possibilities with black & white or color film. In color photography, unlike black & white, there is no possibility to change contrast or color saturation with colored filters. To do so would also change the colors in the photograph. Natural light spreads in a wave form in all direction. Sunlight is polarized and has a high color purity. When passing through the atmosphere a part of it is scattered which results in a bluish gray haze over all colors. This effect can be reduced or eliminated by using polarizing filters. If, in addition, light falls at a 35-40% angle on a reflecting surface (water, glass, plastic, color surfaces), the light



becomes reflected and polarized. If you properly orientate the filter, the reflections are absorbed and the true colors can reach the film. Water surfaces become transparent and clouds are more saturated. Heliopan polarizing filters consist of a neutral color foil cemented between two plane parallel glass discs. The foil is constructed so that light rays can only pass in only one plane. The polarizer is mounted in a calibrated rotating ring so the desired position and effect can be easily set. With an SLR camera one sees the results in the finder, with viewfinder type cameras one holds the polarizer in front of the eye and turns it to see the desired effects. Then with the assistance of the calibrated rim (on every Heliopan polarizer), it is easy to set the filter to the same position on the lens.



without Polarizer



with Polarizer

There are basically two kinds of polarizers: linear and circular. The circular is required with all autofocus cameras, using a linear polarizer will cause incorrect focusing measurements. The circular polarizer has a second component, a 1/4 wave plate in its construction. The polarized light is set in rotation by this plate and can therefore pass without interruption through the measuring system and give proper measurements.

For wide angle, Heliopan also offers a "slim" circular polarizing filter that will also work on lenses as short as 21mm without vignetting. Like all Heliopan polarizers, the rim is fully calibrated to indicate the axis of polarization and the convenient markings make the filters very easy to use on non reflex and non ground glass focusing cameras.

With the calibrations all that is necessary is to hold the filter up to the eye and rotate it until the desired effect is seen. Not the position of any number on the rim, mount the filter on the lens and rotate the mount till the selected number is in the same position as when the filter was held to the eye. As the new "slim" Heliopan circular polarizer has no front threads Heliopan will continue to offer their standard circular polarizer.

**Linear Polarizer:** For all manual viewfinder and SLR cameras

**Circular Polarizer:** For all SLR cameras with TTL metering via the mirror and/or autofocus lenses

**Warm Polarizer:** Warm polarizers are polarizing foils combined with a KR1.5 skylight filter. Especially suited for lenses that have cold tones.

**Kasemann Linear Polarizer:** These meet the highest quality standards. Has a special edge sealing for extreme climate conditions. Assures the highest optical performance, especially with long focal length lenses.

**Kasemann Circular Polarizer:** Same as above except for all SLR cameras with TTL metering via the mirror and/or autofocus lenses

**Wide-Angle Polarizer:** Especially made for wide angle lenses. The front thread size is increased to avoid vignetting.

**SLIM Polarizers:** Available in linear and circular versions, these filters have an extremely thin rim of only 5mm, eliminating the possibility of vignetting when using wide angle lenses or zoom lenses at their wide angle setting.

**SH-PMC (Multicoated) Polarizers:** SH-PMC filters are coated with 8 layers on each side. This not only reduces the reflections in the visible areas of the spectrum to almost 0% but it also repels moisture and dust. Provides the greatest protection against damage to the filter and is easier to clean than the lens itself.



[www.bhphotovideo.com](http://www.bhphotovideo.com)

# HELIOPAN

## POLARIZER FILTERS

FILTERS

361

| POLARIZER FILTERS                           |                                   |        |        |        |        |        |        |        |        |         |
|---|-----------------------------------|--------|--------|--------|--------|--------|--------|--------|--------|---------|
| Filter Size (mm)                            | 30.5                              | 37     | 39     | 40.5   | 46     | 48     | 49     | 52     | 55     | 58      |
| Linear Polarizer #HEP( )                    | 42.95                             | —      | 38.95  | 44.95  | 39.95  | 42.95  | 42.95  | 44.95  | 45.95  | 53.95   |
| Circular Polarizer #HECP( )                 | 59.95                             | 50.95  | 57.50  | 64.95  | 61.95  | 61.95  | 61.95  | 65.95  | 68.95  | 74.95   |
| Circular Polarizer-SLIM #HECPS( )           | —                                 | —      | 57.50  | 64.95  | 61.95  | 61.95  | 61.95  | 65.95  | 68.95  | 74.95   |
| SH-PMC Circular Polarizer #HECPSMC( )       | —                                 | 82.95  | 87.50  | 73.95  | 91.95  | 93.50  | 93.50  | 94.50  | 106.95 | 112.95  |
| SH-PMC Circular Polarizer-SLIM #HECPSMCS( ) | —                                 | 82.95  | 87.50  | 87.50  | 91.95  | 93.50  | 93.50  | 94.50  | 106.95 | 112.95  |
| Kaesmann Linear Polarizer #HEKP( )          | Call for availability and pricing |        |        |        |        |        |        |        |        |         |
| Kaesmann Linear Polarizer-W/A #HEKP( )W     | Call for availability and pricing |        |        |        |        |        |        |        |        |         |
| Kaesmann Circular Polarizer #HEKCP( )       | Call for availability and pricing |        |        |        |        |        |        |        |        |         |
| Kaesmann Circular Polarizer-W/A #HEKCP( )WA | Call for availability and pricing |        |        |        |        |        |        |        |        |         |
| Kaesmann Warm Linear Polarizer #HEKWP( )    | Call for availability and pricing |        |        |        |        |        |        |        |        |         |
| Kaesmann Warm Circular Polarizer #HEKWCP( ) | Call for availability and pricing |        |        |        |        |        |        |        |        |         |
| Filter Size (mm)                            | 60                                | 62     | 67     | 69     | 72     | 77     | 82     | 86     | 95     | 105     |
| Linear Polarizer #HEP( )                    | 59.95                             | 59.95  | 69.95  | —      | 79.95  | 82.95  | 112.95 | 144.95 | 196.50 | 219.95  |
| Circular Polarizer #HECP( )                 | 78.95                             | 78.95  | 92.95  | 125.95 | 109.95 | 125.95 | 149.95 | 199.95 | 284.95 | 308.50  |
| Circular Polarizer-SLIM #HECPS( )           | 78.95                             | 78.95  | 92.95  | —      | 109.95 | 125.95 | 149.95 | 199.95 | 284.95 | 308.50  |
| SH-PMC Circular Polarizer #HECPSMC( )       | 122.95                            | 122.95 | 139.95 | 177.95 | 154.95 | 177.95 | 197.95 | 254.95 | 299.95 | —       |
| SH-PMC Circular Polarizer-SLIM #HECPSMCS( ) | 122.95                            | 122.95 | 139.95 | 177.95 | 154.95 | 177.95 | 197.95 | 254.95 | 299.95 | —       |
| Kaesmann Linear Polarizer #HEKP( )          | Call for availability and pricing |        |        |        |        |        |        |        |        |         |
| Kaesmann Linear Polarizer-W/A #HEKP( )W     | Call for availability and pricing |        |        |        |        |        |        |        |        |         |
| Kaesmann Circular Polarizer #HEKCP( )       | Call for availability and pricing |        |        |        |        |        |        |        |        |         |
| Kaesmann Circular Polarizer-W/A #HEKCP( )WA | Call for availability and pricing |        |        |        |        |        |        |        |        |         |
| Kaesmann Warm Linear Polarizer #HEKWP( )    | Call for availability and pricing |        |        |        |        |        |        |        |        |         |
| Kaesmann Warm Circular Polarizer #HEKWCP( ) | Call for availability and pricing |        |        |        |        |        |        |        |        |         |
| Filter Size (mm)                            | Bay 1                             | Bay 2  | Bay 3  | Bay 4  | Bay 6  | Bay 8  | Bay 50 | Bay 60 | Bay 70 | Bay 104 |
| Linear Polarizer #HEP( )                    | 73.95                             | 87.95  | 89.95  | —      | 169.95 | —      | 129.95 | 152.95 | 159.95 | —       |
| Circular Polarizer #HECP( )                 | 102.95                            | 109.95 | 114.95 | —      | 246.50 | —      | 154.95 | 209.95 | 214.95 | —       |
| Circular Polarizer-SLIM #HECPS( )           | —                                 | —      | —      | —      | —      | —      | —      | —      | —      | —       |
| SH-PMC Circular Polarizer #HECPSMC( )       | —                                 | —      | —      | —      | 224.95 | —      | —      | 189.95 | 239.95 | —       |
| SH-PMC Circular Polarizer-SLIM #HECPSMCS( ) | —                                 | —      | —      | —      | —      | —      | —      | —      | —      | —       |
| Kaesmann Linear Polarizer #HEKP( )          | Call for availability and pricing |        |        |        |        |        |        |        |        |         |
| Kaesmann Linear Polarizer-W/A #HEKP( )W     | Call for availability and pricing |        |        |        |        |        |        |        |        |         |
| Kaesmann Circular Polarizer #HEKCP( )       | Call for availability and pricing |        |        |        |        |        |        |        |        |         |
| Kaesmann Circular Polarizer-W/A #HEKCP( )WA | Call for availability and pricing |        |        |        |        |        |        |        |        |         |
| Kaesmann Warm Linear Polarizer #HEKWP( )    | Call for availability and pricing |        |        |        |        |        |        |        |        |         |
| Kaesmann Warm Circular Polarizer #HEKWCP( ) | Call for availability and pricing |        |        |        |        |        |        |        |        |         |

1. In the parenthesis insert the filter size. For example, a 67mm Circular Polarizer would be HECP67.

2. For Bay sizes insert just the letter B and the number. For example, Linear Polarizer in Bay 104 would be HEPB104.

ORDER & INFO. (212) 502-6340 • FAX: (212) 239-7770 (800) 947-7008  
1-800-290-6750 • www.bhphotovideo.com



# HELIOPAN

## COLOR CONVERSION FILTERS

FILTERS

362

The use of conversion filters lets you match the color temperature of the lighting to the film, or to modify the color balance at will. By the correct use of conversion filters, daylight films (approximately 5600K) can be balanced with artificial light and artificial light films (approximately 3200K) to daylight. KB filters increase the color temperature, KR filters reduce it.

**KB 1.5 (82A):** Often called a morning evening filter, this slightly blue filter removes the reddish yellow cast during morning and evening hours. Increases color temperature by 200K. Useful for wildlife photography.

**KB 3 (82C):** The KB 3 has a similar but stronger effect than the KB 1.5. It corrects the red cast from tungsten light when using type B film

**KB 6 (80C):** Medium blue violet filter increase color temp. by 1400K. It eliminates the strong red cast in morning and evening light, plus balances strong yellow and brown cast in some situations. Used in theater and stage photography.

**KB12 (80B):** This reversal filter converts daylight slide film to use 3400K lamps. (eg. photo floods or halogen lamps).

| Filter Type | Filter Factor EV | Filter Factor LV | Change In Color Temperature Kelvin |       | Film Type            | Change In Kelvin Temperature | Mired Value |
|-------------|------------------|------------------|------------------------------------|-------|----------------------|------------------------------|-------------|
| KB 1.5      | 1x               | -0               | 3000K                              | 3200K | tungsten film type B | 200K                         | -15         |
| KB 3        | 1.5x             | -0.7             | 2800K                              | 3200K |                      | 400K                         | -30         |
| KB 6        | 2.0x             | -1.0             | 4100K                              | 5500K | daylight film        | 1400K                        | -60         |
| KB 9        | 2.5x             | -1.3             | 3800K                              | 5500K |                      | 1700K                        | -90         |
| KB 12       | 3.0x             | -1.7             | 3400K                              | 5500K | daylight film        | 2100K                        | -120        |
| KB 15       | 4.0x             | -2.0             | 3200K                              | 5500K |                      | 2300K                        | -150        |
| KB 20       | 5.0x             | -2.3             | 2800K                              | 5500K |                      | 2700K                        | -200        |

**KB 15 (80):** For use with daylight film and 3200K tungsten lamps (60 to 100w)

**KB 18:** Increases the color temperature by approximately 2700K and can be used with candle light. Can also be used to achieve night effects during daylight.

### COLOR CONVERSION FILTERS

|                             |       |       |       |       |        |       |        |        |        |         |
|-----------------------------|-------|-------|-------|-------|--------|-------|--------|--------|--------|---------|
| Filter Size (mm)            | 30.5  | 37    | 39    | 40.5  | 46     | 48    | 49     | 52     | 55     | 58      |
| Color Conversion #HE( ) ( ) | 20.80 | 21.50 | 27.50 | 27.95 | 23.95  | 27.95 | 23.95  | 24.50  | 27.50  | 28.50   |
| Filter Size (mm)            | 60    | 62    | 67    | 69    | 72     | 77    | 82     | 86     | 95     | 105     |
| Color Conversion #HE( ) ( ) | 37.50 | 37.50 | 42.50 | 61.75 | 52.75  | 61.75 | 81.95  | 101.95 | 144.50 | 169.95  |
| Filter Size (mm)            | Bay 1 | Bay 2 | Bay 3 | Bay 4 | Bay 6  | Bay 8 | Bay 50 | Bay 60 | Bay 70 | Bay 104 |
| Color Conversion #HE( ) ( ) | —     | —     | 54.95 | —     | 138.95 | —     | 93.95  | 113.50 | —      | —       |

Insert the filter type (KB1.5, KB3, KB6, KB12, KB15, KB18 or KR1.5, KR3, KR6, KR12, KR15 or 81A, 81B 81C) in the first parenthesis, then the filter size in the second parenthesis.

**KR 1.5 (Skylight):** This light salmon colored filter reduces the bluish cast in scenic photography, snow scenes, or of normal objects around noon time. It absorbs UV radiation and serves as a protective filter which can be left on the lens at all times. The KR 1.5 is closer to Tiffen and Hoya's 81A filters. The Heliopan 81A filter may be too dark for some photographers preference's. No exposure compensation required.

**KR 3 (81C)** This slightly darker salmon colored filter has a stronger effect than the KR1.5. Especially useful in hazy sun light or cloudy overcast sky and at higher elevations.

**KR 6 (81EF):** Medium reddish filter ideal for photos with daylight color film in deep shadow with sunny illumination, or for interior architecture (churches) without additional illumination on cloudy days.

**KR 12 (85):** Reddish brown filter converts tungsten slide film to daylight

| Filter Type | Filter Factor EV | Filter Factor LV | Change In Color Temperature Kelvin |       | Film Type            | Change In Kelvin Temperature | Mired Value |
|-------------|------------------|------------------|------------------------------------|-------|----------------------|------------------------------|-------------|
| KR 1.5      | 1x               | -0               | 3400K                              | 3200K | tungsten film type B | 200K                         | 15          |
| KR 3        | 1.2x             | -0.3             | 3600K                              | 3200K |                      | 400K                         | 30          |
| KR 6        | 1.5x             | -0.7             | 3900K                              | 3200K |                      | 700K                         | 60          |
| KR 9        | 1.8x             | -0.9             | 4500K                              | 3200K |                      | 1300K                        | 90          |
| KR 12       | 2.0x             | -1.0             | 5500K                              | 3400K | type A               | 2100K                        | 120         |
| KR 15       | 2.3x             | -1.3             | 5500K                              | 3200K | tungsten film type B | 2300                         | 150         |
| 81 A        | 1.2x             | -0.3             | 3400K                              | 3200K |                      | 200K                         | 20          |
| 81 B        | 1.2x             | -0.3             | 3500K                              | 320K  |                      | 300K                         | 27          |
| 81 C        | 1.3x             | -0.3             | 3600K                              | 3200  |                      | 400K                         | 35          |

**KR 15 (85B):** Reduces the color temperature by 2500K to balance daylight film to artificial light type B film.

**81A, 81B and 81C** These slightly brownish filters are similar to the KR 3. The correction however is brownish. Ideal for portrait and figure photography. the skin tones are more pleasingly reproduced, each one causes approximately a 100K change in the color correction. They allow for fine adjustment of light balance.



For Any Inquiries Regarding Your Order, Call Our Customer Service:  
(800) 221-5743 • (212) 239-7765 • FAX: (800) 947-2215 • (212) 239-7549

## SPECIALTY FILTERS

### F-Day

This is a fluorescent filter used to correct the green cast created when using daylight film under fluorescent lamps with daylight tubes. The filter restores the natural colors.

### Close-up Lenses

Close-up lenses shorten the focal length at the same focus setting. No exposure correction is necessary. Lenses are available in three strengths and can be used in combination.

### Soft Focus Filters

These filters have finely etched circular prismatic lines which create an effective soft mood at open aperture. Ideal for esthetic and artistic expressions. Available in two strengths "0" and "1". (May not work with AF systems).

### Soft Spot

The soft spot with a plain ground spot in the center—all other surrounding details fade out in a blurred effect—will expand your artistic expression and create new moods. The degree of the blurred effect varies with lens focal length and aperture opening.

**Cross Screen:** Cross screen filters create star-like effects of spectral light sources. This is how it works: The light on the subject forms the stars. The stronger the light and the darker the background, the more dramatic is the star effect. Ideal for special-effects of spot lights at night, headlights in on-coming traffic, sun reflections or rippling water surfaces. Best results with long focal length lenses, open aperture and with the filter very close to the camera lens.

### Zeiss Softars

The optimum in soft focus filters. In comparison with other diffusers, the Softars maintain a basic sharpness at any aperture for greater depth of field without changing softness. Long a requirement for the portrait photographer, Softars are available in two strengths and can be combined with each other.

### Neutral Density Wide Angle Center Filters

Many wide angle lenses exhibit fall-off (darkening) at the edges. This can be improved with a center filter which has a progression from dark gray in the center to clear at the edges. Wide angle center filters are available in two densities: ND-0.45 (filter factor 3x, or +1.5 stops) and ND-0.9 (filter factor 8x, +3 stops).

### F-DAY, CLOSE-UP, SOFT, SPOT, CROSS SCREEN & W/A CENTER FILTERS

| Filter Size (mm)                      | 30.5                              | 37     | 39     | 40.5  | 46     | 48     | 49     | 52     | 55     | 58      |
|---------------------------------------|-----------------------------------|--------|--------|-------|--------|--------|--------|--------|--------|---------|
| F-Day                                 | —                                 | —      | —      | —     | 36.50  | —      | 36.50  | 38.50  | 46.95  | 49.95   |
| Close-up Lenses #HECU( ) ( )          | —                                 | —      | —      | —     | 23.95  | —      | 23.95  | 24.95  | 27.50  | 28.50   |
| Soft Focus #HESF0( ) or #HESF1( )     | —                                 | —      | —      | —     | 36.50  | —      | 36.50  | 38.50  | 46.95  | 49.50   |
| Spot Lens #HESS( )                    | —                                 | —      | —      | —     | 47.95  | —      | 47.95  | 48.95  | 54.95  | 59.95   |
| Zeiss Softar #HEZS1( ) or #HEZS2( )   | —                                 | —      | —      | —     | —      | —      | 209.95 | 219.95 | 229.95 | 229.95  |
| Cross Screen                          | —                                 | —      | —      | —     | 43.50  | —      | 43.50  | 43.50  | 45.95  | 49.95   |
| ND Wide Angle Center Filter #HECF3( ) | —                                 | —      | —      | —     | —      | —      | 192.50 | 339.95 | 339.95 | 339.95  |
| Filter Size (mm)                      | 60                                | 62     | 67     | 69    | 72     | 77     | 82     | 86     | 95     | 105     |
| F-Day                                 | 56.95                             | 56.95  | 68.50  | —     | 79.95  | 104.95 | —      | —      | —      | —       |
| Close-up Lenses #HECU( ) ( )          | —                                 | 37.50  | 42.95  | —     | 52.75  | 61.75  | —      | —      | —      | —       |
| Soft Focus #HESF0( ) or #HESF1( )     | 56.95                             | 56.95  | 68.50  | —     | 79.95  | 104.95 | —      | —      | —      | —       |
| Spot Lens #HESS( )                    | —                                 | 62.50  | 73.50  | —     | 79.95  | 89.95  | —      | —      | —      | —       |
| Zeiss Softar #HEZS1( ) or #HEZS2( )   | —                                 | 234.95 | 249.95 | —     | 249.95 | 294.95 | —      | —      | —      | —       |
| Cross Screen                          | —                                 | 56.95  | 62.95  | —     | 75.95  | 94.95  | 119.95 | —      | —      | —       |
| ND Wide Angle Center Filter #HECF3( ) | —                                 | —      | 287.95 | —     | —      | 364.95 | 379.95 | —      | —      | —       |
| Filter Size (mm)                      | Bay 1                             | Bay 2  | Bay 3  | Bay 4 | Bay 6  | Bay 8  | Bay 50 | Bay 60 | Bay 70 | Bay 104 |
| F-Day                                 | Call for availability and pricing |        |        |       |        |        |        |        |        |         |
| Close-up Lenses #HECU( ) ( )          | Call for availability and pricing |        |        |       |        |        |        |        |        |         |
| Soft Focus #HESF0( ) or #HESF1( )     | Call for availability and pricing |        |        |       |        |        |        |        |        |         |
| Spot Lens #HESS( )                    | Call for availability and pricing |        |        |       |        |        |        |        |        |         |
| Zeiss Softar #HEZS1( ) or #HEZS2( )   | Call for availability and pricing |        |        |       |        |        |        |        |        |         |
| Cross Screen                          | Call for availability and pricing |        |        |       |        |        |        |        |        |         |
| ND Wide Angle Center Filter #HECF3( ) | Call for availability and pricing |        |        |       |        |        |        |        |        |         |

For close-up lenses insert the strength in the first parenthesis (1, 2 or 3), then the filter size in the second parenthesis. For all other filters simply insert the filter size.



## RESIN FILTERS

The Hitech Resin filters are designed for the professional photographer and videographer. These filters are made of special C39 resin that transmits more light than glass filters and are lighter, unbreakable and scratch-resistant. The 4x4" (100 x 100mm) resin filters are 1.5mm thick and fit most filter holders, including the Hitech holder system which is completely machine crafted from aluminum, as are the adapters. The vast range of adapters, holders and hoods allow the system to be used on any format camera, from 35mm to 8x10, including on rear of view lenses.

Hitech's filters are made of lens-quality optical resin—not plastic, and their manufacturing standards of flatness and optical purity are unmatched anywhere. The filters are "dyed through", that is, Hitech dyes its CR39 resin when still liquid and casts all its filters with the color (whether CC, CTC, color grad, etc.) throughout the thickness of the filter. The filters are therefore much more scratch-resistant and cleanable.



### FEATURES

- ◆ Optical resin base is far sturdier than glass or gelatin filters, easy and safe to clean.
- ◆ Surface is flatter than polished glass filters, more scratch-resistant than gels.
- ◆ Precision anodized-aluminum holder allows years of hard use, comes in designs for wide-angle and normal (or longer) lenses; spring-loaded slots allow easy and secure insertion, positioning, and removal.
- ◆ Base is dyed-through rather than surface-dyed or glass-sandwiched, for enhanced optical performance and durability.
- ◆ Available in a greater range of filter types than gel or glass; they come in 4x4-inch and 85mm (Cokin P-compatible) sizes.

### State-of-the-Art Optical Resin makes Hitech Filters a Match for the Finest Lenses

Demanding photographers spend thousand of dollars on lenses. Sad to say, many of them aren't getting the most from their investment. Why? Because they're shooting with second-rate filters—filters that soften or distort the subject before an expensive lens can even begin its work. The best glass money can buy can't undo the damage caused by a bad filter.

#### Resin vs. Glass

Glass filters are generally manufactured in two different ways. In the first, a colored gel is simply cemented between two clear sheets of glass—a sandwich that may compromise sharpness. In the second, a sheet of clear glass is surface-dyed. This means even a small scratch can remove color and affect filtering ability. In fact, some glass filter makers warn you not to use lens cleaning tissues or solutions on their products for fear you'll abrade the that delicate surface.

Hitech filters are made from a single sheet of ultraflat optical resin, dyed all the way through. So if you scratch them, there's more than enough color left to do the job. Scratches on Hitech filters can even be polished out simply by rubbing a little tooth-paste into the filter's surface with your finger.

#### Resin vs. Gelatin

Gelatin filters are notoriously vulnerable to scratching. And unlike Hitech filters, they simply can't be cleaned. As any filter-savvy photographer will tell you, even with careful use, a gel accumulates dust, nicks, and grease. When that build-up reaches a critical mass, your only option is to throw the filter away—and that can get expensive.

Hitech's 4x4" optical resin filters cost more than 3x3" gels, but hanks to the durability of Hitech's construction and the permanence of the dyes, they can last a lifetime. They clean very nicely with lens tissue and solution. At 1.5mm in thickness, they're also immune to the buckling and dimpling that plagues gelatin filters. How often have you opened a properly-stored gel and found it so badly warped you're afraid to use it.

#### Resin vs. Plastic

Manufacturers of plastic filters make similar claims, but don't be fooled. Their products simply aren't made to the same high specifications as Hitech filters. Hitech dyes are not only color correct to the highest standard in the industry, but are so carefully mixed with optical resin that their distribution is absolutely uniform. By comparison, plastic filters may often contain tiny flecks of undissolved dye.

Flatness is another Hitech specialty. Hitech filters are not only far flatter than the competition, but are even flatter than lens makers can polish optical glass. So rest assured that when you put a Hitech filter on an expensive lens, you'll get the top-notch performance you expect from your investment!

## FILTER HOLDERS & ADPTERS RINGS

### 4x4" Filter Holders

At the heart of the Hitech system is its elegant filter holder. Rigid yet light-weight, the Hitech holder's precision-machined aluminum construction can withstand a lifetime of professional use.



Filters slide smoothly in and out of the holder's spring-loaded slots with just enough tension to keep them securely in place. This is especially important when you're positioning a graduated filter to match your composition. There are several types of filter holders for Hitech's 4x4" (100mm) filters:

- The standard model (HT1002) has slots for three filters, plus a large 105mm threaded mounting ring on the front of the holder accepts high-quality glass screw-in filters and lens hoods.
- The wide-angle model (HT1004) has two filter slots and no front ring, which allows vignette-free shooting even with wide-angle lenses having large front elements.
- A third model (HT1005) is available for special situations. It combines a single slot with a 105mm threaded front ring, making it useful when you want to combine a polarizer with a wide-angle lens.

**HT1002 Filter Holder (HIFH44):** 3-slot with 105mm threaded front ring.....**149.95**

**HT1004 Wide-Angle Filter Holder (HIFHWA44):** 2-slot with no front ring.....**134.95**

**HT1005 Filter Holder (HIFH44Q):** 1-slot with 105mm threaded front ring.....**143.95**

### Hoods/Lens Adapter Cap

**HT1010 Lens Hood:** Rubber 105mm screw-in.....**CALL**

**HT1013 Lens Hood (HILHM10535):** Metal 35mm deep (105mm screw-in).....**99.95**

**HT1015 Lens Hood (HILHM10570):** Metal 70mm deep (105mm screw-in).....**99.95**

**HT1016 Adapter Cap (HIAC):** Protects lens with adapter ring attached .....**22.50**

### Lens Adapter Rings for 4x4" Filter Holders

The holder is secured to the lens with an adapter ring. Adapter rings come in both screw- and bayonet-mount versions, from 49mm to 105mm. Wide-angle adapter rings are available in the same size range and can be used with any holder model.



|                                   |              |  |              |
|-----------------------------------|--------------|--|--------------|
| 49mm Adapter Ring (HIAR4944)..... | <b>38.50</b> | 77mm Adapter Ring (HIAR7744).....        | <b>38.50</b> |
| 52mm Adapter Ring (HIAR5244)..... | <b>38.50</b> | 82mm Adapter Ring (HIAR8244).....        | <b>64.95</b> |
| 55mm Adapter Ring (HIAR5544)..... | <b>38.50</b> | 86mm Adapter Ring (HIAR8644).....        | <b>64.95</b> |
| 58mm Adapter Ring (HIAR5844)..... | <b>38.50</b> | 95mm Adapter Ring (HIAR9544).....        | <b>89.50</b> |
| 60mm Adapter Ring (HIAR6044)..... | <b>38.50</b> | 105mm Adapter Ring (HIAR10544).....      | <b>89.50</b> |
| 62mm Adapter Ring (HIAR6244)..... | <b>38.50</b> | Hass. B-50 Adapter Ring (HIARB5044)..... | <b>64.95</b> |
| 67mm Adapter Ring (HIAR6744)..... | <b>38.50</b> | Hass. B-60 Adapter Ring (HIARB6044)..... | <b>64.95</b> |
| 72mm Adapter Ring (HIAR7244)..... | <b>38.50</b> | Hass. B-70 Adapter Ring (HIARB7044)..... | <b>64.95</b> |

### Wide Angle Lens Adapter Rings for 4x4" Filter Holders

|                                       |              |   |              |
|---------------------------------------|--------------|---|--------------|
| 49mm W/A Adapter Ring (HIARWA49)..... | <b>63.95</b> | 67mm W/A Adapter Ring (HIARWA67).....               | <b>63.95</b> |
| 52mm W/A Adapter Ring (HIARWA52)..... | <b>63.95</b> | 72mm W/A Adapter Ring (HIARWA72).....               | <b>63.95</b> |
| 55mm W/A Adapter Ring (HIARWA55)..... | <b>63.95</b> | 77mm W/A Adapter Ring (HIARWA77).....               | <b>63.95</b> |
| 58mm W/A Adapter Ring (HIARWA58)..... | <b>63.95</b> | 82mm W/A Adapter Ring (HIARWA82).....               | <b>71.95</b> |
| 60mm W/A Adapter Ring (HIARWA60)..... | <b>63.95</b> | Hasselblad Bay 60 W/A Adapter Ring (HIARWAB60)..... | <b>95.95</b> |
| 62mm W/A Adapter Ring (HIARWA62)..... | <b>63.95</b> |   |              |

## HITECH for Cokin 'P'

Hitech's comprehensive filter system featuring rigid (1.5mm) optical resin filters are also available in 85mm (Cokin P) widths in a complete range of CC, CTC, ND, black-and-white, and special effects types. Holders come in normal and wide-angle designs.

### 85-Series (Cokin P-compatible) Filter Holders

|   |               |
|---|---------------|
| <b>Filter Holder (HT1008):</b> 1-slot with 95mm threaded front ring (HIFHCP)..... | <b>143.95</b> |
| <b>HT1009 Wide-Angle Filter Holder (HIFHWACP):</b> 2-slot with no front ring..... | <b>131.95</b> |
| <b>Rubber Lens Hood (HT1012):</b> Fits the HT1008 (95mm screw-in) (HILHFHCP)..... | <b>95.95</b>  |

### Lens Adapter Rings for Cokin 85mm Filter Holders

|                                   |              |   |              |
|-----------------------------------|--------------|---|--------------|
| 49mm Adapter Ring (HIAR49CP)..... | <b>38.50</b> | 62mm Adapter Ring (HIAR62CP).....             | <b>38.50</b> |
| 52mm Adapter Ring (HIAR52CP)..... | <b>38.50</b> | 67mm Adapter Ring (HIAR67CP).....             | <b>38.50</b> |
| 55mm Adapter Ring (HIAR55CP)..... | <b>38.50</b> | 72mm Adapter Ring (HIAR72CP).....             | <b>38.50</b> |
| 58mm Adapter Ring (HIAR58CP)..... | <b>38.50</b> | 77mm Adapter Ring (HIAR77CP).....             | <b>38.50</b> |
| 60mm Adapter Ring (HIAR60CP)..... | <b>38.50</b> | Hasselblad B-60 Adapter Ring (HIARB60CP)..... | <b>64.95</b> |

## RESIN FILTERS

### Blank Filters

These clear resin flats have no effect - until you add your own. They can be smeared with petroleum jelly or other substances, drilled or etched, or hand-colored to produce any number of special effects.

#### 4 x 4" and 4 x 5"

4x4" Optically Clear (HIB44) .....**23.95**  
 4x5" Optically Clear (HIB45) .....**31.95**

#### Cokin P

85 x 85mm Optically Clear (HIBCP) .....**22.50**  
 85 x 107mm Optically Clear (HIBCPG) .....**26.95**

### UV Absorbing

UV filters correct for ultraviolet light which can register on film as a bluish cast and can obscure distant details. Known as a skylight filter, the UV (1A) filters are pale pink. They absorb ultraviolet radiation and reduce the excess bluishness of outdoor color scenes photographed in open shade under a clear, blue sky. The UV (2B) filter is useful for high altitude photography and eliminates almost all UV present.

#### 4x4" (100mm)

UV-Absorbing 1A (HIUV1A44) .....**45.95**  
 UV-Absorbing 2B (HIUV2B44) .....**45.95**

#### Cokin P (85mm)

UV-Absorbing 1A (HIUV1ACP) .....**28.95**  
 UV-Absorbing 2B (HIUV2BCP) .....**28.95**

### Polarizer

Often used by photographers to increase color saturation. Their main application is in eliminating reflections on windows, water, or other shiny surfaces. Available only as 105mm screw-in for HT1002 and HT1005 holders in both linear and circular versions.

Linear Polarizer (HIP105) .....**399.95**

### Fluorescent Correction

Designed for use in fluorescent light of mixed or unknown type, these filters minimize the green-to-blue cast fluorescent light otherwise creates.

#### 4x4" (100mm)

FL-D filter f/daylight film (HIFLD44) .....**45.95**  
 FL-B filter for tungsten film (HIFLB44) .....**45.95**

#### Cokin P (85mm)

FL-D filter f/daylight film (HIFLDCP) .....**28.95**  
 FL-B filter f/tungsten film (HIFLBCP) .....**28.95**

### Color Temperature Correction (CTC)

These allow you to balance different light sources with your film. The bluish 80 series converts day-light film for use with tungsten light; the salmon-colored 85 series converts tungsten film for use in daylight. Other CTC filters are made for fine-tuning color balance. The light blue 82 series is mildly cooling; and the amber-colored 81 series produces slight warming.

#### COLOR TEMPERATURE CORRECTION (CTC) FILTERS

| Filter           | Exposure | Type    | Conversion       | 4x4"     | Price | 85mm (Cokin P) | Price |
|------------------|----------|---------|------------------|----------|-------|----------------|-------|
| 80A Blue         | +2       | Cooling | 3200°K to 5500°K | HI80A44  | 45.95 | HI80ACP        | 31.95 |
| 80B Blue         | +123     | Cooling | 3400°K to 5500°K | HI80B44  | 45.95 | HI80BCP        | 31.95 |
| 80C Blue         | +1       | Cooling | 3800°K to 5500°K | HI80C44  | 45.95 | HI80CCP        | 31.95 |
| 80D Blue         | +1/3     | Cooling | 4200°K to 5500°K | HI80D44  | 45.95 | HI80DCP        | 31.95 |
| 82 Light Blue    | +1/3     | Cooling | 3100°K to 3200°K | HI8244   | 45.95 | HI82CP         | 31.95 |
| 82A Light Blue   | +1/3     | Cooling | 3000°K to 3200°K | HI82A44  | 45.95 | HI82ACP        | 31.95 |
| 82B Light Blue   | +2/3     | Cooling | 2900°K to 3200°K | HI82B44  | 45.95 | HI82BCP        | 31.95 |
| 82C Light Blue   | +2/3     | Cooling | 2800°K to 3200°K | HI82C44  | 45.95 | HI82CCP        | 31.95 |
| 81 Light Amber   | +1/3     | Warming | 3300°K to 3200°K | HI8144   | 45.95 | HI81CP         | 31.95 |
| 81A Light Amber  | +1/3     | Warming | 3400°K to 3200°K | HI81A44  | 45.95 | HI81ACP        | 31.95 |
| 81B Light Amber  | +1/3     | Warming | 3500°K to 3200°K | HI81B44  | 45.95 | HI81BCP        | 31.95 |
| 81C Light Amber  | +1/3     | Warming | 3600°K to 3200°K | HI81C44  | 45.95 | HI81CCP        | 31.95 |
| 81D Light Amber  | +2/3     | Warming | 3700°K to 3200°K | HI81D44  | 45.95 | HI81DCP        | 31.95 |
| 81EF Light Amber | +2/3     | Warming | 3850°K to 3200°K | HI81EF44 | 45.95 | HI81EFCP       | 31.95 |
| 85 Amber         | +2/3     | Warming | 5500°K to 3400°K | HI8544   | 45.95 | HI85CP         | 31.95 |
| 85B Amber        | +2/3     | Warming | 5500°K to 3200°K | HI85B44  | 45.95 | HI85BCP        | 31.95 |
| 85C Amber        | +1/3     | Warming | 5500°K to 3800°K | HI85C44  | 45.95 | HI85CCP        | 31.95 |

### Color Compensating (CC)

Also used in printing, these filters are designed for fine-tuning color balance. Available in densities of from .025 to .50 (including a rare and useful .15), in the customary yellow, magenta, cyan, red, green, and blue.

To order Hitech 4x4" Color Conversion filters, just insert filter density into item number in blank space.

|       |       |       |
|-------|-------|-------|
| CC20Y | CC20M | CC20C |
| CC20R | CC20G | CC20B |

#### COLOR CONVERSION (CC) FILTERS

| Density | .025 | .05  | .10  | .15  | .20  | .30  | .40  | .50  | Item #     | Price |
|---------|------|------|------|------|------|------|------|------|------------|-------|
| Yellow  | nil  | nil  | +1/3 | +1/3 | +1/3 | +1/3 | +1/3 | +2/3 | HICC( )Y44 | 45.95 |
| Magenta | nil  | +1/3 | +1/3 | +1/3 | +1/3 | +2/3 | +2/3 | +2/3 | HICC( )M44 | 45.95 |
| Cyan    | nil  | +1/3 | +1/3 | +1/3 | +1/3 | +2/3 | +2/3 | +1   | HICC( )C44 | 45.95 |
| Red     | nil  | +1/3 | +1/3 | +1/3 | +1/3 | +2/3 | +2/3 | +1   | HICC( )R44 | 45.95 |
| Green   | nil  | +1/3 | +1/3 | +1/3 | +1/3 | +2/3 | +2/3 | +1   | HICC( )G44 | 45.95 |
| Blue    | nil  | +1/3 | +1/3 | +1/3 | +2/3 | +2/3 | +1   | +1/3 | HICC( )B44 | 45.95 |

The chart shows a guide to exposure increase you will require, in f-stops.

In the parenthesis insert the filter size. For example, a .40 Yellow CC filter would be HICC40Y44.



## RESIN FILTERS

### Neutral Density

Neutral density (ND) filters are a colorless gray and cause an overall reduction in the level of light reaching the lens. This is useful for creating creative techniques. In outdoor portraiture, particularly with long lenses, it lets you shoot at wide apertures to soften the background; in landscapes, it lets you use a fast film to create a grainy effect. ND filters are available in 6 specific densities (1/3 stop increments up to one stop, and one-stop increments up to four-stops), and can be stacked for precise control.

#### 4x4" (100mm)

- ND 0.1 (HIND.144): 1/3-stop reduction ....**67.50**
- ND 0.2 (HIND.244): 2/3-stop reduction ....**67.50**
- ND 0.3 (HIND.344): 1-stop reduction .....**67.50**
- ND 0.6 (HIND.644): 2-stop reduction .....**67.50**
- ND 0.9 (HIND.944): 3-stop reduction .....**67.50**
- ND 1.2 (HIND.1.244): 4-stop reduction.....**67.50**

#### Cokin P (85mm)

- ND 0.1 (HIND.1CP): 1/3-stop reduction ...**35.95**
- ND 0.2 (HIND.2CP): 2/3-stop reduction ...**35.95**
- ND 0.3 (HIND.3CP): 1-stop reduction.....**35.95**
- ND 0.6 (HIND.6CP): 2-stop reduction.....**35.95**
- ND 0.9 (HIND.9CP): 3-stop reduction.....**35.95**
- ND 1.2 (HIND.9CP): 4-stop reduction.....**35.95**

### Black-and-White

These filters give black-and-white photographers a high degree of creative control over an image's tonal values. They help prevent printing problems and enhance darkroom technique. Use them to reduce or eliminate atmospheric haze, to make more natural tonal reproduction in monochrome photographs, and to give deliberate emphasis to certain objects. The yellow-to-red range is often used for outdoor and landscape photography, increasing effective contrast by reducing haze and progressively darkening blue sky. Yellow simply restores sky areas (otherwise rendered too light by the film's high sensitivity to blue) to a middle tone, creating a natural-looking contrast with clouds; orange and red filters make sky darker than it normally appears, so that clouds stand out more dramatically. Green and yellow-green filters lighten foliage and slightly darken a blue sky. Light blue and blue filters correct tonal reproduction under tungsten light.

- #8 Yellow:** Greatly increases contrast and is particularly useful for mid-day sun and deep shadows. Accentuates clouds, considerably reduces haze and reproduces distance better.
- #8 Yellow (HI844):** 4x4" .....**45.95**
- #8 Yellow (HI8CP):** For Cokin P.....**31.95**
- #11 Yellow-Green:** Retains tonal values, but reduces haze and brightens green.
- #11 Yellow-Green (HI1144):** 4x4" .....**45.95**
- #11 Yellow-Green (HI11CP):** For Cokin P ...**31.95**
- #21 Orange:** Accentuates red picture parts set off against green or blue. For example, it will make clouds brighter against the sky.
- #21 Orange (HI2144):** 4x4" .....**45.95**
- #21 Orange (HI21CP):** For Cokin P .....**31.95**
- #58 Green:** Generally used when improved reproduction of green is needed. For example, when shooting forests, gardens and meadows.
- #58 Green (HI5844):** 4x4" .....**45.95**

- #25 Red:** Suppresses blue and brightens red. Also suppresses red lettering, red stamps, etc.
- #21 Orange (HI2544):** 4x4" .....**45.95**
- #21 Orange (HI25CP):** For Cokin P .....**31.95**
- #38 Light Blue:** Corrects the tendency of reds to reproduce too lightly under tungsten lighting; when used for portraits, skin tones are more natural and modeling is improved.
- #38 Light Blue (HI3844):** 4x4" .....**45.95**
- #38 Light Blue (HI38CP):** For Cokin P .....**31.95**
- #47 Blue:** Accentuates haze and fog, creating dense, moody atmospheric effects in landscape and marine scenes.
- #47 Blue (HI4744):** 4x4" .....**45.95**
- #47 Blue (HI47CP):** For Cokin P .....**31.95**
- #58 Green (HI58CP):** For Cokin P .....**31.95**

### 4x5" Neutral Density Graduates

A specific neutral density on one half of these valuable filters tapers off toward the middle, the filter remaining clear on the other half. This allows controlled placement of neutral density in specific image areas, especially useful for deepening overly bright skies (and holding foreground detail) in landscapes. (The Hitech holder is perfectly designed to allow easy, secure adjustments to the filter's position.) ND grads are 4x5" rather than 4x4", the extra inch of length allowing more precise positioning of the transitional zone. A "hard-edged" version (with a less gradual transition) is also available, and recommended for subjects with a clearly defined horizon line.



#### NEUTRAL DENSITY GRADUATE FILTERS

| Filter           | Exposure | 4x4"   | Price | 85mm (Cokin P) | Price |
|------------------|----------|--------|-------|----------------|-------|
| ND 0.3 Soft Edge | 1-stop   | ND1406 | 45.95 | ND1406-85      | 39.95 |
| ND 0.6 Soft Edge | 2-stop   | ND1407 | 45.95 | ND1407-85      | 39.95 |
| ND 0.9 Soft Edge | 3-stop   | ND1408 | 45.95 | ND1408-85      | 39.95 |
| ND 1.2 Soft Edge | 4-stop   | ND1409 | 45.95 | ND1409-85      | 39.95 |
| ND 0.3 Hard Edge | 1-stop   | ND1410 | 45.95 | ND1410-85      | 39.95 |
| ND 0.6 Hard Edge | 2-stop   | ND1411 | 45.95 | ND1411-85      | 39.95 |
| ND 0.9 Hard Edge | 3-stop   | ND1412 | 45.95 | ND1412-85      | 39.95 |
| ND 1.2 Hard Edge | 4-stop   | ND1413 | 45.95 | ND1413-85      | 39.95 |

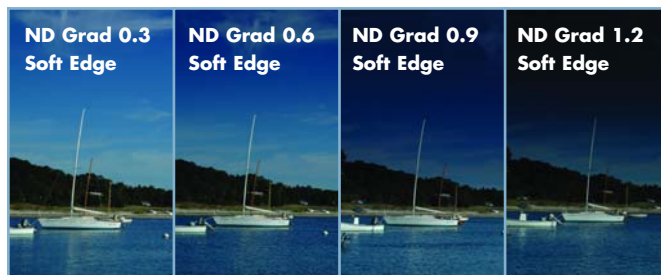

## RESIN FILTERS

### 4x5" Color Graduates

These 4x5" filters are similar to ND grads, but substitute a wide range of hues for neutral density. The color fades to clear toward the center, allowing you to warm a sky, for example, without altering the landscape itself. Among the most used color grads are sepia, coral, Tuscan pink and tobacco.

|  |              |
|--|--------------|
| Sky Blue #2 (HIGSB245) .....                 | 48.95        |
| Cool Blue #1 (HIGCB145).....                 | 48.95        |
| Cool Blue #2 (HIGCB245).....                 | 48.95        |
| <b>Tobacco #1 (HIGTO145) .....</b>           | <b>48.95</b> |
| <b>Tobacco #2 (81EF) (HIGTO245).....</b>     | <b>48.95</b> |
| <b>Tobacco #3 (HIGTO345) .....</b>           | <b>48.95</b> |
| <b>Yellow #1 (HIGY145) .....</b>             | <b>48.95</b> |
| <b>Yellow #2 (HIGY245) .....</b>             | <b>48.95</b> |
| <b>Yellow #3 (B&amp;W#8) (HIGY345) .....</b> | <b>48.95</b> |
| <b>Sepia #1 (HIGS145).....</b>               | <b>48.95</b> |
| <b>Sepia #2 (HIGS245).....</b>               | <b>48.95</b> |
| <b>Sepia #3 (HIGS345).....</b>               | <b>48.95</b> |
| <b>Coral #1 (HIGC145).....</b>               | <b>48.95</b> |
| <b>Coral #2 (85) (HIGC245).....</b>          | <b>48.95</b> |
| <b>Coral #3 (HIGC345).....</b>               | <b>48.95</b> |
| <b>Chocolate #1 (HIGCH145).....</b>          | <b>48.95</b> |
| <b>Chocolate #2 (HIGCH245).....</b>          | <b>48.95</b> |
| <b>Chocolate #3 (HIGCH345).....</b>          | <b>48.95</b> |
| <b>Orange #1 (HIGO145) .....</b>             | <b>48.95</b> |
| <b>Orange #2 (HIGO245) .....</b>             | <b>48.95</b> |
| <b>Orange #3 (B&amp;W#21) (HIGO345).....</b> | <b>48.95</b> |
| <b>Strawberry #1 (HIGST145) .....</b>        | <b>48.95</b> |
| <b>Strawberry #2 (HIGST245) .....</b>        | <b>48.95</b> |
| <b>Strawberry #3 (HIGST345) .....</b>        | <b>48.95</b> |
| <b>Apricot #1 (85B) (HIGA145).....</b>       | <b>48.95</b> |
| <b>Apricot #2 (HIGA245) .....</b>            | <b>48.95</b> |
| <b>Apricot #3 (HIGA345) .....</b>            | <b>48.95</b> |
| <b>Cerise #1 (HIGC145Q) .....</b>            | <b>48.95</b> |
| <b>Cerise #2 (HIGC245Q) .....</b>            | <b>48.95</b> |
| <b>Cerise #3 (HIGC345Q) .....</b>            | <b>48.95</b> |
| <b>Red #1 (HIGR145).....</b>                 | <b>48.95</b> |
| <b>Red #2 (HIGR245).....</b>                 | <b>48.95</b> |
| <b>Red #3 (B&amp;W#25) (HIGR345) .....</b>   | <b>48.95</b> |
| <b>Tuscan Pink #1 (HIGTP145).....</b>        | <b>48.95</b> |
| <b>Tuscan Pink #2 (HIGTP145).....</b>        | <b>48.95</b> |
| <b>Tuscan Pink #3 (HIGTP345).....</b>        | <b>48.95</b> |

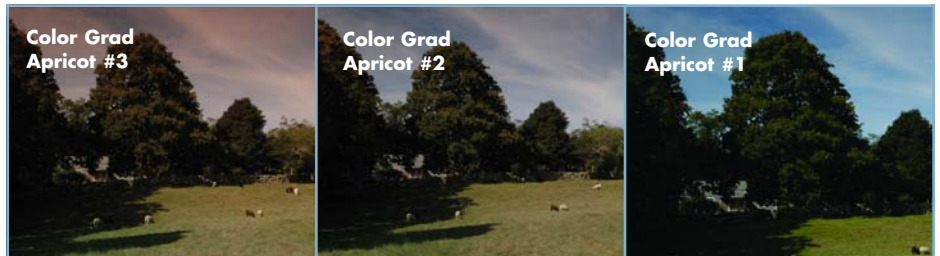
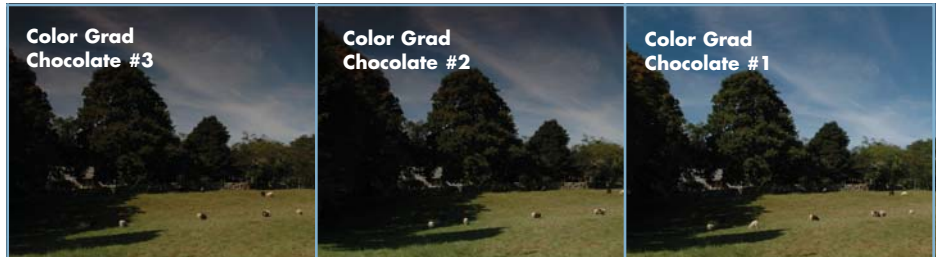



## RESIN FILTERS

### 85mm x 110mm (Cokin P) Color Graduates

Like the 4x5" color graduates, the Cokin P-compatible color graduates are similar to ND grads, but substitute a wide range of hues for neutral density. The color fades to clear toward the center, allowing you to warm a sky, for example, without altering the landscape itself. Among the most used color grads are sepia, coral, Tuscan pink and tobacco.

|                                   |       |
|-----------------------------------|-------|
| Sky Blue #2 (HIGSB2CP) .....      | 38.50 |
| Cool Blue #1 (HIGCB1CP).....      | 38.50 |
| Cool Blue #2 (HIGCB2CP).....      | 38.50 |
| Tobacco #1 (HIGTO1CP) .....       | 38.50 |
| Tobacco #2 (81EF) (HIGTO2CP)..... | 38.50 |
| Tobacco #3 (HIGTO3CP) .....       | 38.50 |
| Yellow #1 (HIGY1CP).....          | 38.50 |
| Yellow #2 (HIGY2CP).....          | 38.50 |
| Yellow #3 (B&W#8) (HIGY3CP) ..... | 38.50 |
| Sepia #1 (HIGS1CP).....           | 38.50 |
| Sepia #2 (HIGS2CP).....           | 38.50 |
| Sepia #3 (HIGS3CP).....           | 38.50 |
| Coral #1 (HIGC1CP) .....          | 38.50 |
| Coral #2 (85) (HIGC2CP).....      | 38.50 |
| Coral #3 (HIGC3CP).....           | 38.50 |
| Chocolate #1 (HIGCH1CP).....      | 38.50 |
| Chocolate #2 (HIGCH2CP).....      | 38.50 |
| Chocolate #3 (HIGCH3CP).....      | 38.50 |
| Orange #1 (HIGO1CP) .....         | 38.50 |
| Orange #2 (HIGO2CP) .....         | 38.50 |
| Orange #3 (B&W#21) (HIGO3CP)..... | 38.50 |
| Strawberry #1 (HIGST1CP).....     | 38.50 |
| Strawberry #2 (HIGST2CP).....     | 38.50 |
| Strawberry #3 (HIGST3CP).....     | 38.50 |
| Apricot #1 (85B) (HIGA1CP).....   | 38.50 |
| Apricot #2 (HIGA2CP).....         | 38.50 |
| Apricot #3 (HIGA3CP) .....        | 38.50 |
| Cerise #1 (HIGC185CPQ) .....      | 38.50 |
| Cerise #2 (HIGC285CPQ) .....      | 38.50 |
| Cerise #3 (HIGC385CPQ) .....      | 38.50 |
| Red #1 (HIGR1CP) .....            | 38.50 |
| Red #2 (HIGR2CP) .....            | 38.50 |
| Red #3 (B&W#25) (HIGR3CP).....    | 38.50 |
| Tuscan Pink #1 (HIGTP1CP).....    | 38.50 |
| Tuscan Pink #2 (HIGTP2CP).....    | 38.50 |
| Tuscan Pink #3 (HIGTP3CP).....    | 38.50 |



## RESIN FILTERS

FILTERS

370

### Combination Graduates

These unique filters offer a degree of image control that in the past has required a risky “pack” of two or three filters, if it has been possible at all. Autumn #3 + ND .3, for example, has a graduated amber hue on one end and graduated neutral density on the other, letting you simultaneously warm a foreground and keep a sky from becoming too light - especially useful at dusk or dawn.

#### 4x5" (100mm)

|  |       |
|--|-------|
| 81B + ND 0.3 (HIG81BND.345).....         | 82.95 |
| 81B + ND 0.6 (HIG81BND.645).....         | 82.95 |
| 81B + ND 0.9 (HIG81BND.945).....         | 82.95 |
| 81EF + ND 0.3 (HIG81EFND.34).....        | 82.95 |
| 81EF + ND 0.6 (HIG81EFND.64).....        | 82.95 |
| 81EF + ND 0.9 (HIG81EFND.94).....        | 82.95 |
| Twilight #3 + ND 0.3 (HIGTL3ND.345)..... | 82.95 |
| Twilight #3 + ND 0.6 (HIGTL3ND.645)..... | 82.95 |
| Twilight #3 + ND 0.9 (HIGTL3ND.945)..... | 82.95 |
| Sunset #3 + ND 0.3 (HIGSS3ND.345).....   | 82.95 |
| Sunset #3 + ND 0.6 (HIGSS3ND.645).....   | 82.95 |
| Sunset #3 + ND 0.9 (HIGSS3ND.945).....   | 82.95 |
| Autumn #3 + ND 0.3 (HIGA3ND.345).....    | 82.95 |
| Autumn #3 + ND 0.6 (HIGA3ND.645).....    | 82.95 |
| Autumn #3 + ND 0.9 (HIGA3ND.945).....    | 82.95 |

#### Cokin P (85mm x 110mm)

|                                  |       |                                   |       |
|----------------------------------|-------|-----------------------------------|-------|
| 81B + ND 0.3 (HIG81BND.3CP)..... | 59.95 | 81EF + ND 0.3 (HIG81EFND.3C)..... | 59.95 |
| 81B + ND 0.6 (HIG81BND.6CP)..... | 59.95 | 81EF + ND 0.6 (HIG81EFND.6C)..... | 59.95 |
| 81B + ND 0.9 (HIG81BND.9CP)..... | 59.95 | 81EF + ND 0.9 (HIG81EFND.9C)..... | 59.95 |



### Two-Color Graduates

Similar to straight color grads, these filters incorporate two hues to enhance certain atmospheric phenomena. The Sunset filter, for example, starts out with an orangy red on one end and dissolves to a soft band of yellow, which in turn tapers off to clear in the middle. It's effective for both intensifying existing sunset colors and simulating the effect of sunset with a cloudy or hazy sky.

#### 4x5" (100mm)

|                               |       |
|-------------------------------|-------|
| Twilight #1 (HITCGTL145)..... | 82.95 |
| Twilight #2 (HITCGTL245)..... | 82.95 |
| Twilight #3 (HITCGTL345)..... | 82.95 |
| Sunset #1 (HITCGSS145).....   | 82.95 |
| Sunset #2 (HITCGSS245).....   | 82.95 |
| Sunset #3 (HITCGSS345).....   | 82.95 |
| Autumn #1 (HITCGA145).....    | 82.95 |
| Autumn #2 (HITCGA245).....    | 82.95 |
| Autumn #3 (HITCGA345).....    | 82.95 |

#### Cokin P (85mm x 110mm)

|                               |       |
|-------------------------------|-------|
| Twilight #1 (HITCGTL1CP)..... | 59.95 |
| Twilight #2 (HITCGTL2CP)..... | 59.95 |
| Twilight #3 (HITCGTL3CP)..... | 59.95 |
| Sunset #1 (HITCGSS1CP).....   | 59.95 |
| Sunset #2 (HITCGSS2CP).....   | 59.95 |
| Sunset #3 (HITCGSS3CP).....   | 59.95 |
| Autumn #1 (HITCGA1CP).....    | 59.95 |
| Autumn #2 (HITCGA2CP).....    | 59.95 |
| Autumn #3 (HITCGA3CP).....    | 59.95 |





## RESIN FILTERS

FILTERS

371

### Effects Filters

*These offer a variety of starburst effects as well as several different kinds of softening. In addition to minimizing skin flaws, white net and fog filters create varying degrees of halation around highlights as well as a useful reduction in overall contrast. Black net filters minimize skin flaws without halation, and for that reason are more popular for portraits of men. Star filters cause specular highlights to streak in two, four, six or eight directions.*

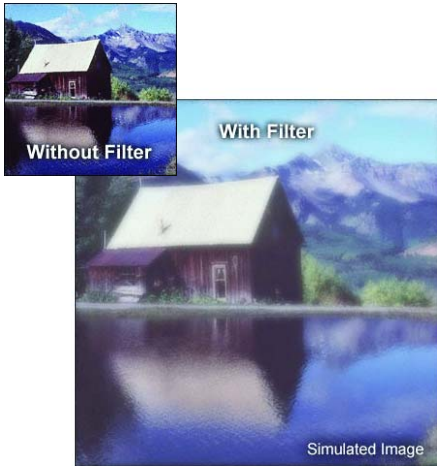

Fog #2 (HIF244)

#### 4x4" (100mm)

|                                    |       |
|------------------------------------|-------|
| Softnet White #1 (HISNW144) .....  | 42.95 |
| Softnet White #2 (HISNW244) .....  | 42.95 |
| Softnet Black #1 (HISNB144) .....  | 42.95 |
| Softnet Black #2 (HISNB244) .....  | 42.95 |
| Fog #1 (HIF144) .....              | 42.95 |
| Fog #2 (HIF244) .....              | 42.95 |
| 4-point Star Filter (HIS444) ..... | 45.95 |
| 6-point Star Filter (HIS644) ..... | 45.95 |
| 8-point Star Filter (HIS844) ..... | 45.95 |

#### Cokin P (85mm x 110mm)

|                                    |       |
|------------------------------------|-------|
| Softnet White #1 (HISNW1CP) .....  | 31.95 |
| Softnet White #2 (HISNW2CP) .....  | 31.95 |
| Softnet Black #1 (HISNB1CP) .....  | 31.95 |
| Softnet Black #2 (HISNB2CP) .....  | 31.95 |
| Fog #1 (HIF1CP) .....              | 31.95 |
| Fog #2 (HIF2CP) .....              | 31.95 |
| 4-point Star Filter (HIS4CP) ..... | 31.95 |
| 6-point Star Filter (HIS6CP) ..... | 31.95 |
| 8-point Star Filter (HIS8CP) ..... | 31.95 |



6-point Star Filter

Softnet White #1



### Movie Mists

*Originally designed for motion picture use, these filters offer controlled degrees of diffusion, their effect produced by a laser-printed microdot pattern. Both the clear mist and black mist are useful for minimizing wrinkles and blemishes in portraiture, but the clear also causes halation of highlights and lowers contrast.*



Movie Mist Black #4 (HIMMB444)

#### 4x5" (100mm)

|                                      |       |
|--------------------------------------|-------|
| Movie Mist Clear #1 (HIMMC144) ..... | 52.50 |
| Movie Mist Clear #2 (HIMMC244) ..... | 52.50 |
| Movie Mist Clear #3 (HIMMC344) ..... | 52.50 |
| Movie Mist Clear #4 (HIMMC444) ..... | 52.50 |
| Movie Mist Black #1 (HIMMB144) ..... | 52.50 |
| Movie Mist Black #2 (HIMMB244) ..... | 52.50 |
| Movie Mist Black #3 (HIMMB344) ..... | 52.50 |
| Movie Mist Black #4 (HIMMB444) ..... | 52.50 |

#### Cokin P (85mm x 110mm)

|                                      |       |
|--------------------------------------|-------|
| Movie Mist Clear #1 (HIMMC1CP) ..... | 39.95 |
| Movie Mist Clear #2 (HIMMC2CP) ..... | 39.95 |
| Movie Mist Clear #3 (HIMMC3CP) ..... | 39.95 |
| Movie Mist Clear #4 (HIMMC4CP) ..... | 39.95 |
| Movie Mist Black #1 (HIMMB1CP) ..... | 39.95 |
| Movie Mist Black #2 (HIMMB2CP) ..... | 39.95 |
| Movie Mist Black #3 (HIMMB3CP) ..... | 39.95 |
| Movie Mist Black #4 (HIMMB4CP) ..... | 39.95 |

## Hoya Filters—The Difference is Clear

### How another large manufacturer makes filters

Some filters are made with a thin gel or even colored glue laminate sandwiched between two pieces of regular clear glass, similar to the glass used in window panes. These types of filters are cheap to produce, but inferior for several reasons:

1. Over time the expansion and contraction of the different materials can lead to de-lamination, which is a separation of the different materials. This will show up as bubbling, peeling, or discoloration, rendering the filter useless.
2. The color of the gel can shift or fade over a relatively short period of time.
3. If all six surfaces, three layers, two surfaces each, are not perfectly flat and perfectly parallel, the filter causes a “lens effect” which degrades the optical performance, or in extreme cases, shift or limit the focus of the lens it is used with.

### How Hoya Makes Filters

To make colored filters, Hoya adds different raw elements, like gold, and chemicals to its optical glass while it is in a molten state. This insures that filter glass is uniformly colored all the way through. There is never any risk of uneven coloration, shifting or fading of the color, or delamination. The two surfaces are ground and polished for perfect flatness.

### Hoya coating and multi-coating, the quality difference:

Hoya manufactures a full line of filters in both standard and Hoya multi-coated. The difference between Hoya's standard line and that of other manufacturers is that Hoya filters have one layer of anti-reflective coating applied to each surface of the glass. Other manufacturers standard filters are bare glass, and bare glass can reflect as much as 9% of the light hitting it. This greatly increases the risks of flare and ghosting.

To provide photographers with a higher quality professionals require, Hoya created the Multi-coated line of filters. These filters have a three layer coating system that further reduces light reflections off the surfaces of the glass, the average is only 1-2%. This means that 98-99% of the light striking the filter is going through it, and depending on the type of filter, into the camera lens and onto the film. These layers of anti-reflective coating are bonded to the surface of the glass in a furnace at a temperature of up to 800°F.

Beware, some manufacturers claim to have “coated” filters. But this coating is often only applied to the front side of the glass, not both sides like Hoya filters. Also, the coating on many filters is “painted” on or applied as a cold spray that wears off easily.

In 1996 Hoya introduced Super Multi-coated filters, which have a 5+1 layering system on each side of the glass: 5 layers of anti-reflective coating and a transparent easy-clean top coat, which reduces light reflections off the filter surface to an average of just 0.3%. This is the lowest reflective rate from any filter manufacturer.

### The Glass:

How is the glass itself made? How do filters get their color? Some manufacturers simply take two thin sheets of regular glass and sandwich a colored gel in-between. This process is called lamination. It is a very cost-effective process but not a high quality one. Remember, the disadvantage of this process is that over time the different materials can separate, causing bubbling or peeling (referred to as delamination,) rendering the filter useless. Also the thin gel used can shift its color so that the filter does not yield the same color rendition over time. The last drawback of this process is that all six surfaces of the three layers have to be perfectly flat and parallel. If they are not, the filter will have a “lens effect” which can greatly reduce image quality.

To insure consistency in glass manufacturing, Hoya uses a furnace called an Automatic V blender to mix the different materials at a highly controlled rate. This process creates glass that is pigmented all the way through. With pigmented glass there is no chance shifting over time. There is also no chance of delamination. Also, the two surfaces of the glass are ground and polished for perfect flatness.

The only exceptions are polarizer and circular polarizer filters. No matter the brand or quality, they all are made of a polarizing film, or a polarizing film and quarter wave plate in the case of the circular polarizer, sandwiched between two layers of glass.

### The Filter Frame:

Hoya believes the filter frame is an extremely important part of the filter as well. They use machined aluminum frames to hold the glass because it is strong enough to last for years of use. Some say that brass is a better material, Hoya disagrees and here's why; brass is a far more rigid material than either aluminum or the polycarbonates used in today's lens barrels. This means that, should the front of the lens get hit, the rigid brass filter ring will transfer almost all the force of the shock to the lens barrels and mechanics. An aluminum filter frame will absorb some of the shock by bending and at a certain point the glass will chip or break, which is what the filter is supposed to do, protect the lens. Replacing a filter is always preferable to getting a lens repaired.

### The Value in a Hoya Multi-Coated Filter

Today's photographers want to get the most speed, optical performance, and dollar performance from their investment. Say someone pays \$500.00 for a 28-70mm f/2.8 lens, and protects it with a cheap bare glass filter, which has a light reflection rate of 9%. This filter is literally slowing the lens down by 9%, effectively turning a \$500 f/2.8 lens into the equivalent of a slower f/3.0 lens worth \$455. The value of the lens drops 9% with the cheap filter on it. The cost savings of the less expensive filter do not offset the loss of lens speed, nor does it address the loss of sharpness or focus shift, which can have a noticeable impact on picture quality. For these reasons, Hoya multi-coated filters present the best value on the market today.

### Standard

These filters offer amateur and professional photographers Hoya's famous quality at reasonable prices. Hoya utilizes high quality optical glass and bonds a layer of anti-reflectant coating to each surface of the glass to suppress reflection and increase light transmission. Other manufacturer's standard filters are just bare glass that can reflect as much as 10% of the light striking it. Hoya standard single layer coating reduced that to 5%.

### HMC (Hoya Multi-Coated)

These filters are renowned for their ability to minimize reflection at the filter surfaces which reduces flare and ghosting. Hoya creates better images by taking its optical glass and bonding 3 layers of anti-reflectant coatings to each surface to reduce average reflection down to just 3.0% or less. The result is an average light transmission of over 97%, giving sharp contrast and well balanced color.

### HMC Ultra Thin Series

The same as the HMC filters (3 layers of anti-reflectant coatings bonded to each surface of the glass to reduce average reflection down to just 3.0% or less) except they use Hoya's ultra thin rings which are designed primarily to avoid vignetting problems which occur with wide angle lenses. The filters use rings just 3mm in thickness, except for the hybrid UV/Polarizer which has a 5mm rotating ring. To accomplish this, Hoya has removed the front threads from the filter but includes a "push-on" lens cap to protect the glass.

### S-HMC (Super HMC)

These outstanding filters offer revolutionary performance in light transmission and color balance. 6 layers of anti-reflectant coatings are bonded to each surface of the glass to reduce average reflection down to an industry leading 0.3% - that is an average transmission of 99.7%! Coupled with maximum surface precision, this increases resistance to flare and stunning images can be recorded at wide apertures without compromising lens performance. The circular polarizers have seven layers of multicoating applied to their rear surface to eliminate internal reflections and ghosting. Advanced thin selective film guarantees perfectly polarized light with neutral color balance. Their slim profile of just 5mm avoids any vignetting problems and makes them ideal for use with wide angle lenses. There is no front female thread, but they do accept Hoya's push-on lens caps.



77mm HMC Circular Polarizer



77mm HMC Pro 1 Circular Polarizer

### Super HMC PRO 1

Patented optical glass technology creates hardened glass only 1mm thick! This 1mm hardened glass has the same strength as standard Hoya optical glass that is 3mm thick, a Hoya exclusive! 6 layers of anti-reflectant coatings are bonded to each

surface of the glass to reduce average reflection down to an industry leading 0.3%. Low profile 4mm frame reduces the risks of vignetting, perfect for wide and ultra-wide angle lenses. PRO 1 filters are low profile but have front filter threads so a standard clip-on lens cap can be used.

### HOYA FILTER GUIDE - Circular Polarizer, UV, Skylight

| Type of Filter                     | Hoya Coating | Frame Thickness | Glass Thickness | Front Threads | Size Availability |                  |
|------------------------------------|--------------|-----------------|-----------------|---------------|-------------------|------------------|
| <b>Circular Polarizer (Cir-PL)</b> |              |                 |                 |               |                   |                  |
| Super HMC PRO 1                    | Cir-PL       | Super HMC       | 4mm             | 1mm           | Yes               | 49 to 82mm       |
| S-HMC                              | Cir-PL       | Super HMC       | 5mm             | 3mm           | No                | 52 to 82mm       |
| Ultra Thin Series                  | Cir-PL       | HMC             | 5mm             | 3mm           | No                | 58 to 77mm       |
| HMC                                | Cir-PL       | HMC             | 7mm             | 3mm           | Yes               | 46 to 82mm       |
| Circular Polarizer                 | Cir-PL       | None            | 7mm             | 3mm           | Yes               | 40.5, 43 to 82mm |
| MOOSE                              | Cir-PL       | None            | 7mm             | 3mm           | Yes               | 46 to 82mm       |
| <b>UV / Skylight</b>               |              |                 |                 |               |                   |                  |
| Super HMC PRO 1                    | UV/SKY       | Super HMC       | 4mm             | 1mm           | Yes               | 49 to 82mm       |
| S-HMC                              | UV/SKY       | Super HMC       | 5mm             | 3mm           | No                | 52 to 82mm       |
| Ultra Thin Series                  | UV/SKY       | HMC             | 3mm             | 3mm           | No                | 58 to 77mm       |
| HMC                                | UV/SKY       | HMC             | 5mm             | 3mm           | No                | 46 to 82mm       |
| UV/SKYLIGHT                        | UV/SKY       | Uni-Coated      | 5mm             | 3mm           | Yes               | 40.5, 43 to 82mm |



## GENERAL FILTERS



This group includes everyday filters which can be left on your lenses, such as Skylight 1B, UV and Polarizing. These are the first filters that every photographer should make sure they own. Skylight and UV filters should be constantly fitted to a lens to give improved clarity and color balance as well as offering protection to your lens. Polarizing filters have several uses such as eliminating unwanted reflections, increasing color saturation and enhancing contrast.

### UV (0)

Absorbs the ultraviolet rays which often makes outdoor photographs hazy and indistinct. A multi-purpose fine-weather filter for color as well as black and white films. Also serves as a permanent lens protector.

### Skylight 1B

Reduces the excessive bluishness that frequently occurs in outdoor color photography, especially in open shade under a clear, blue sky. The absorption peak is in the range which corresponds to the film's green spectrum. This means outstanding outdoor shots with superb color balance and clarity under all conditions. Also keeps skin tones free of colored reflections from nearby objects such as the shade of trees.

### Neutral

Mounted in an ULTRA slim 3mm ring, this is the ultimate in clear filters. Made from completely transparent superior grade optical glass, it will not affect the color balance or performance of your lenses in the slightest. However, constant use will protect your valued lenses from expensive front element damage which could be caused by dirt, knocks and scratches.



▲  
without  
Polarizer filter



▼  
with  
Polarizer filter



without UV (0)



with UV (0)

### Linear and Circular Polarizers

Light rays which are reflected by any surface become polarized and polarizing filters are used to select which light rays enter your camera lens. PL (Linear Polarizing) and PL-CIR (Circular Polarizing) filters have the same effect, but it is important that you choose the correct version for your camera. They allow you to remove unwanted reflections from non-metallic surfaces such as water, glass etc. They also enable colors to become more saturated and appear clearer, with better contrast. This effect is often used to increase the contrast and saturation in blue skies and white clouds. HOYA's polarizing filters do not affect the overall color balance of a shot.

### UV/Circular Polarizer

A revolutionary 'hybrid' design which combines the effect of two different filters in one ring. This filter eliminates ultraviolet rays to remove haze from outdoor shots as well as polarizing the light to remove reflections, and increase color saturation, without affecting the overall color balance. Fitted in a slim rotating 5mm ring, it will be invaluable to landscape and other photographers who need avoid vignetting with wide angle lens.

### Cleaning Your Filters:

Due to their high precision, filters should always be handled with care and kept clean whenever possible. Filters should be cleaned gently with just a lens tissue or soft cotton cloth. Never use any chemicals, such as lens cleaning fluid, on your filters, as these can damage the coatings. If any stubborn stains occur, these can usually be washed off with some clean water and a soft cotton cloth.

## GENERAL FILTERS

| UV (0), SKYLIGHT, POLARIZER             |       |       |       |       |       |       |       |       |       |        |        |
|---|-------|-------|-------|-------|-------|-------|-------|-------|-------|--------|--------|
| Filter Size (mm)                        | 27    | 28    | 30    | 30.5  | 37    | 39    | 40.5  | 43    | 46    | 49     | 52     |
| UV (0) #HOUV()                          | 11.95 | 11.95 | 11.95 | 11.95 | 9.95  | 22.50 | 22.50 | 22.50 | 11.95 | 11.95  | 11.95  |
| UV (0) HMC #HOUVMC()                    | 17.95 | 17.95 | 17.95 | 17.95 | 11.95 | —     | —     | —     | 17.95 | 17.95  | 17.95  |
| UV (0) HMC Ultra Thin #HOUVU()          | —     | —     | —     | —     | —     | —     | —     | —     | —     | —      | —      |
| UV (0) S-HMC #HOUSMC()                  | —     | —     | —     | —     | —     | —     | —     | —     | —     | —      | 25.50  |
| UV (0) S-HMC Pro-1 #HOUVP1SMC()         | —     | —     | —     | —     | —     | —     | —     | —     | —     | 52.50  | 52.50  |
| Skylight 1B HMC #HOSL()                 | —     | —     | —     | —     | —     | 22.50 | 22.50 | 22.50 | 11.95 | 11.95  | 11.95  |
| Skylight 1B HMC #HOSLMC()               | 22.50 | —     | —     | —     | 22.50 | —     | —     | 22.50 | 17.95 | 17.95  | 17.95  |
| Skylight 1B HMC Ultra Thin #HOSLU()     | —     | —     | —     | —     | —     | —     | —     | —     | —     | —      | —      |
| Skylight 1B S-HMC #HOSLSMC()            | —     | —     | —     | —     | —     | —     | —     | —     | —     | —      | —      |
| Skylight 1B S-HMC Pro-1 #HOSLP1SMC()    | —     | —     | —     | —     | —     | —     | —     | —     | —     | 52.50  | 52.50  |
| Polarizer #HOP()                        | —     | —     | —     | —     | —     | 17.95 | 17.95 | 17.95 | 17.95 | 17.95  | 17.95  |
| Circular Polarizer #HOCP()              | 32.95 | 32.95 | 32.95 | 32.95 | 29.95 | 29.95 | 32.95 | 32.95 | 32.95 | 32.95  | 32.95  |
| Circular Polarizer HMC #HOCPMC()        | —     | —     | —     | —     | —     | —     | —     | —     | 64.50 | 64.50  | 64.50  |
| Circular Polarizer S-HMC #HOCPSMC()     | —     | —     | —     | —     | —     | —     | —     | —     | —     | —      | 68.95  |
| Circular Pola. S-HMC Pro-1 #HOCPP1SMC() | —     | —     | —     | —     | —     | —     | —     | —     | —     | 104.95 | 104.95 |

| UV (0), SKYLIGHT, POLARIZER              |        |        |        |        |        |        |        |        |        |        |        |
|--|--------|--------|--------|--------|--------|--------|--------|--------|--------|--------|--------|
| Filter Size (mm)                         | 55     | 58     | 62     | 67     | 72     | 77     | 82     | 86     | 95     | Bay 50 | Bay 60 |
| UV (0) #HOUV()                           | 11.95  | 13.50  | 20.95  | 20.95  | 31.50  | 35.95  | 43.50  | 79.95  | 85.50  | 59.95  | 80.95  |
| UV (0) HMC #HOUVMC()                     | 17.95  | 20.95  | 29.95  | 29.95  | 37.50  | 40.50  | 58.50  | —      | —      | 89.95  | 103.50 |
| UV (0) HMC Ultra Thin #HOUVU()           | —      | 34.50  | 40.50  | 40.50  | 49.50  | 52.50  | —      | —      | —      | —      | —      |
| UV (0) S-HMC #HOUSMC()                   | 25.50  | 32.95  | 38.95  | 38.95  | 47.95  | 52.50  | 64.50  | —      | —      | —      | —      |
| UV (0) S-HMC Pro-1 #HOUVP1SMC()          | 52.50  | 59.95  | 68.95  | 68.95  | 79.50  | 95.95  | 103.50 | —      | —      | —      | —      |
| Neutral (Clear) HMC Ultra Thin #HONU()   | —      | 34.50  | 40.50  | 39.95  | 49.50  | 52.50  | —      | —      | —      | —      | —      |
| Skylight 1B HMC #HOSL()                  | 11.95  | 13.50  | 20.95  | 20.95  | 31.50  | 35.95  | 43.50  | 79.95  | 85.50  | 59.95  | 80.95  |
| Skylight 1B HMC #HOSLMC()                | 17.95  | 20.95  | 29.95  | 29.95  | 37.50  | 40.50  | 58.50  | —      | —      | —      | —      |
| Skylight 1B HMC Ultra Thin #HOSLU()      | —      | 34.50  | 40.50  | 40.50  | 49.50  | 52.50  | —      | —      | —      | —      | —      |
| Skylight 1B S-HMC #HOSLSMC()             | 25.50  | 32.95  | 38.95  | 38.95  | 47.95  | 52.50  | 64.50  | —      | —      | —      | —      |
| Skylight 1B S-HMC Pro-1 #HOSLP1SMC()     | 52.50  | 59.95  | 68.95  | 68.95  | 79.50  | 95.95  | 103.50 | —      | —      | —      | —      |
| Polarizer #HOP()                         | 17.95  | 20.95  | 20.95  | 20.95  | 34.50  | 40.50  | 56.95  | 97.50  | 113.95 | 64.50  | 80.95  |
| Circular Polarizer #HOCP()               | 32.95  | 37.50  | 53.95  | 53.95  | 64.50  | 76.50  | 99.95  | 144.95 | —      | —      | —      |
| Circular Polarizer HMC #HOCPMC()         | 64.50  | 70.50  | 85.50  | 85.50  | 119.95 | 155.95 | 241.50 | —      | —      | —      | —      |
| Circular Polarizer S-HMC #HOCPSMC()      | 68.95  | 77.95  | 94.50  | 94.50  | 137.95 | 172.50 | 259.95 | —      | —      | —      | —      |
| Circular Pola. S-HMC Pro-1 #HOCPP1SMC()  | 104.95 | 122.95 | 157.50 | 157.50 | 190.50 | 224.95 | 329.95 | —      | —      | —      | —      |
| UV/Circ. Pola. HMC Ultra Thin #HOUCVPU() | —      | 77.95  | 95.95  | 95.95  | 137.95 | 172.50 | —      | —      | —      | —      | —      |

In the parenthesis insert the filter size. For example, a 58mm Skylight 1B HMC filter would be HOSL58.

For Bay sizes insert just the letter B and the number. For example, Polarizer in Bay 60 is HOPB60.

## COLORED FILTERS

As their names suggests, these filters use HOYA colored glass. They are used for color correction of different light sources when using color film, or for controlling contrast with Black & White film. Color correction filters are important as color films do not have the flexibility of the human eye to automatically adjust to different situations. Black & White films register colors as shades of grey and the rendition of each color in a scene is important, so filters can be used to control this. The color of the glass used in all these filters is carefully controlled and to reduce the possibility of color shift over a period of time, such high quality filters are coated or multicoated on both sides. This maintains the desired effect and gives a long service life.

### FL-W/FL-DAY

Used to correct the greenish tone that appears when daylight type films are used under fluorescent lighting. FL-W is for use with warm white or white type fluorescent lamps. FL-DAY is for use with daylight type fluorescent lamps.

It is recommended that auxiliary light sources be used when long exposures become necessary due to insufficient light.

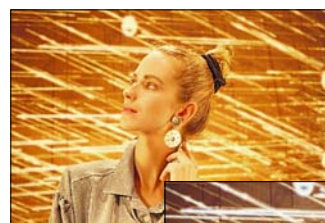

without filter



with 80A filter

**80A/80B/80C:** These are color conversion filters for the use of daylight type color films with artificial light source. 80A increases the color temperature from 3200°K to 5500°K for the use with 3200°K lamps. 80B increases the color temperature from 3400°K to 5500°K for the use of photoflood lamps. 80C increases the color temperature from 3800°K to 5500°K for the use of clear flash bulbs.



without filter



with 85 filter

**85/85B/85C:** These are color conversion filters for the use of tungsten type color films in daylight. 85 decreases the color temperature from 5500°K to 3400°K for the use of Type A color films. 85B decreases the color temperature from 5500°K to 3200°K for the use of Type B color films. 85C decreases the color temperature from 5500°K to 3800°K. The effect obtained is the same as with daylight type color films used in daylight.



## COLORED FILTERS

### 82A/82B/82C

These are light balancing filters used to increase the color temperature slightly for a cooler (bluer) tone. Corrects the tendency toward reddish tones. For example, select the 82B when using tungsten Type B color film (3200°K) with ordinary household 100W electric bulbs (2900°K). These series filters are also used to prevent the reddish tones in early morning or late evening light for natural skin tones. These filters can be used together, but do not mix 81 and 82 series filters since they cancel out each other.



without filter



with 82A



with 82C

### 81A/81B/81C

These are light balancing filters used to decrease the color temperature slightly for a warmer (redder) tone. Corrects the tendency toward bluish tones. For example, the 81A should be selected when using tungsten Type B color film (3200°K) with photoflood lamps (3400°K). These filters can be used together.

**K2 (Yellow):** Especially useful for clear contrast between blue sky with clouds and foreground. Provides a natural tonal rendition. Often used for subjects at intermediate distances

**G (Orange):** Increases contrast between reds and yellows. Particularly useful for distant outdoor shots taken with a telephoto lens. Also useful in color photography for spectacular sunsets, seascapes, etc.

**25A (Red):** Especially effective for increasing contrast. Ideal for dramatic cloud effects in landscapes. Can also be applied creatively in color and infrared photography.



without filter

### X0 (Yellow Green), X1 (Green):

Used primarily for black and white photography. X0 is highly effective for outdoor portraits because red is rendered dark while green appears lighter. Great for correcting skin tones, bringing out facial expressions in close-ups and emphasizing the feeling of liveliness. X1 is highly effective for indoor portraits under tungsten lighting.



without X1



### For Color Film

These filters, such as K2 (Yellow), G (Orange), 25A (Red), X0 (Yellow/green) and X1 (Green) are primarily designed for use with Black & White film. However, they can be used with color film to produce special color effects.

### COLORED FILTERS

| Filter Sizes (mm) | 39    | 40.5  | 43    | Filter Sizes (mm) | 39    | 40.5  | 43    | Filter Sizes (mm) | 39    | 40.5  | 43    |
|-------------------|-------|-------|-------|-------------------|-------|-------|-------|-------------------|-------|-------|-------|
| FL-W #HOFLW( )    | 22.50 | 22.50 | 22.50 | 82A #HO82A( )     | 22.50 | 22.50 | 22.50 | K2 #HOY( )        | 22.50 | 22.50 | 22.50 |
| FL-Day #HOFLD( )  | 22.50 | 22.50 | 22.50 | 82B #HO82B( )     | 22.50 | 22.50 | 22.50 | G #HOG( )         | —     | —     | —     |
| 80A #HO80A( )     | 22.50 | 22.50 | 22.50 | 82C #HO82C( )     | 22.50 | 22.50 | 22.50 | 25A #HOR( )       | 22.50 | 22.50 | 22.50 |
| 80B #HO80B( )     | 22.50 | 22.50 | 22.50 | 81A #HO81A( )     | 22.50 | 22.50 | 22.50 | X0 #HOYG( )       | 22.50 | 22.50 | 22.50 |
| 80C #HO80C( )     | 22.50 | 22.50 | 22.50 | 81B #HO81B( )     | 22.50 | 22.50 | 22.50 | X1 #HOG( )        | 22.50 | 22.50 | 22.50 |
| 85 #HO85( )       | 22.50 | 22.50 | 22.50 | 81C #HO81C( )     | 22.50 | 22.50 | 22.50 |                   |       |       |       |
| 85B #HO85B( )     | 22.50 | 22.50 | 22.50 |                   |       |       |       |                   |       |       |       |
| 85C #HO85C( )     | 22.50 | 22.50 | 22.50 |                   |       |       |       |                   |       |       |       |

In the parenthesis insert the filter size.

For example, a 43mm Skylight 82B filter would be HO82B43.

## COLORED FILTERS

| COLORED FILTERS                 |       |       |       |       |       |       |       |       |       |       |       |        |        |        |
|---------------------------------|-------|-------|-------|-------|-------|-------|-------|-------|-------|-------|-------|--------|--------|--------|
| Filter Size (mm)                | 46    | 49    | 52    | 55    | 58    | 62    | 67    | 72    | 77    | 82    | 86    | 95     | Bay 50 | Bay 60 |
| <b>80A (Standard)</b> #HO80A( ) | 16.50 | 16.50 | 16.50 | 16.50 | 19.50 | 29.95 | 29.95 | 37.50 | 44.95 | 56.95 | 97.50 | 104.95 | 64.50  | 80.95  |
| <b>80A (HMC)</b> #HO80AMC( )    | 22.50 | 22.50 | 22.50 | 22.50 | 25.50 | 35.95 | 35.95 | 43.50 | 44.95 | 61.50 | —     | —      | —      | —      |
| <b>80B (Standard)</b> #HO80B( ) | 16.50 | 16.50 | 16.50 | 16.50 | 19.50 | 29.95 | 29.95 | 37.50 | 44.95 | 56.95 | 97.50 | 104.95 | 64.50  | 80.95  |
| <b>80B (HMC)</b> #HO80BMC( )    | 22.50 | 22.50 | 22.50 | 22.50 | 25.50 | 35.95 | 35.95 | 43.50 | 44.95 | 61.50 | —     | —      | —      | —      |
| <b>80C (Standard)</b> #HO80C( ) | 16.50 | 16.50 | 16.50 | 16.50 | 19.50 | 29.95 | 29.95 | 37.50 | 44.95 | 56.95 | 97.50 | 104.95 | 64.50  | 80.95  |
| <b>80C (HMC)</b> #HO80CMC( )    | 22.50 | 22.50 | 22.50 | 22.50 | 25.50 | 35.95 | 35.95 | 43.50 | 44.95 | 61.50 | —     | —      | —      | —      |
| <b>85 (Standard)</b> #HO85( )   | 16.50 | 16.50 | 16.50 | 16.50 | 19.50 | 29.95 | 29.95 | 37.50 | 44.95 | 56.95 | 97.50 | 104.95 | 64.50  | 80.95  |
| <b>85 (HMC)</b> #HO85MC( )      | 22.50 | 22.50 | 22.50 | 22.50 | 25.50 | 35.95 | 35.95 | 43.50 | 44.95 | 61.50 | —     | —      | —      | —      |
| <b>85B (Standard)</b> #HO85B( ) | 16.50 | 16.50 | 16.50 | 16.50 | 19.50 | 29.95 | 29.95 | 37.50 | 44.95 | 56.95 | 97.50 | 104.95 | 64.50  | 80.95  |
| <b>85B (HMC)</b> #HO85BMC( )    | 22.50 | 22.50 | 22.50 | 22.50 | 25.50 | 35.95 | 35.95 | 43.50 | 44.95 | 61.50 | —     | —      | —      | —      |
| <b>85C (Standard)</b> #HO85C( ) | 16.50 | 16.50 | 16.50 | 16.50 | 19.50 | 29.95 | 29.95 | 37.50 | 44.95 | 56.95 | 97.50 | 104.95 | 64.50  | 80.95  |
| <b>85C (HMC)</b> #HO85CMC( )    | 22.50 | 22.50 | 22.50 | 22.50 | 25.50 | 35.95 | 35.95 | 43.50 | 44.95 | 59.95 | —     | —      | —      | —      |
| <b>82A (Standard)</b> #HO82A( ) | 16.50 | 16.50 | 16.50 | 16.50 | 19.50 | 29.95 | 29.95 | 37.50 | 44.95 | 56.95 | 97.50 | 104.95 | 64.50  | 80.95  |
| <b>82A (HMC)</b> #HO82AMC( )    | 22.50 | 22.50 | 22.50 | 22.50 | 25.50 | 35.95 | 35.95 | 43.50 | 44.95 | 61.50 | —     | —      | —      | —      |
| <b>82B (Standard)</b> #HO82B( ) | 16.50 | 16.50 | 16.50 | 16.50 | 19.50 | 29.95 | 29.95 | 37.50 | 44.95 | 56.95 | 97.50 | 104.95 | 64.50  | 80.95  |
| <b>82B (HMC)</b> #HO82BMC( )    | 22.50 | 22.50 | 22.50 | 22.50 | 25.50 | 35.95 | 35.95 | 43.50 | 44.95 | 61.50 | —     | —      | —      | —      |
| <b>82C (Standard)</b> #HO82C( ) | 16.50 | 16.50 | 16.50 | 16.50 | 19.50 | 29.95 | 29.95 | 37.50 | 44.95 | 56.95 | 97.50 | 104.95 | 64.50  | 80.95  |
| <b>82C (HMC)</b> #HO82CMC( )    | 22.50 | 22.50 | 22.50 | 22.50 | 25.50 | 35.95 | 35.95 | 43.50 | 44.95 | 61.50 | —     | —      | —      | —      |
| <b>81A (Standard)</b> #HO81A( ) | 16.50 | 16.50 | 16.50 | 16.50 | 19.50 | 29.95 | 29.95 | 37.50 | 44.95 | 56.95 | 97.50 | 104.95 | 64.50  | 80.95  |
| <b>81A (HMC)</b> #HO81AMC( )    | 22.50 | 22.50 | 22.50 | 22.50 | 25.50 | 35.95 | 35.95 | 43.50 | 44.95 | 61.50 | —     | —      | —      | —      |
| <b>81B (Standard)</b> #HO81B( ) | 16.50 | 16.50 | 16.50 | 16.50 | 19.50 | 29.95 | 29.95 | 37.50 | 44.95 | 56.95 | 97.50 | 104.95 | 64.50  | 80.95  |
| <b>81B (HMC)</b> #HO81BMC( )    | 22.50 | 22.50 | 22.50 | 22.50 | 25.50 | 35.95 | 35.95 | 43.50 | 44.95 | 61.50 | —     | —      | —      | —      |
| <b>81C (Standard)</b> #HO81C( ) | 16.50 | 16.50 | 16.50 | 16.50 | 19.50 | 29.95 | 29.95 | 37.50 | 44.95 | 56.95 | 97.50 | 104.95 | 64.50  | 80.95  |
| <b>81C (HMC)</b> #HO81CMC( )    | 22.50 | 22.50 | 22.50 | 22.50 | 25.50 | 35.95 | 35.95 | 43.50 | 44.95 | 61.50 | —     | —      | —      | —      |

*In the parenthesis insert the filter size. For example, a 77mm 81C Standard filter would be HO81C77.  
For Bay sizes insert just the letter B and the number. For example, 82B (HMC) in Bay 50 is HO82BMCB50.*

## COLORED FILTERS

### COLORED FILTERS (CONTINUED)

| Filter Size (mm)                       | 46    | 49    | 52    | 55    | 58    | 62    | 67    | 72    | 77    | 82    | 86    | 95     | Bay 50 | Bay 60 |
|--|-------|-------|-------|-------|-------|-------|-------|-------|-------|-------|-------|--------|--------|--------|
| <b>FL-W (Standard) #HOFLW( )</b>       | 16.50 | 16.50 | 16.50 | 16.50 | 19.50 | 29.95 | 29.95 | 37.50 | 44.95 | 56.95 | —     | —      | 104.95 | —      |
| <b>FL-W (HMC) #HOFLWMC( )</b>          | 22.50 | 22.50 | 22.50 | 22.50 | 25.50 | 35.95 | 35.95 | 43.50 | 52.50 | —     | —     | —      | —      | —      |
| <b>FL Day (Standard) #HOFLD( )</b>     | 16.50 | 16.50 | 16.50 | 16.50 | 19.50 | 29.95 | 29.95 | 37.50 | 44.95 | 56.95 | 97.50 | 104.95 | —      | —      |
| <b>FL Day (HMC) #HOFLDMC( )</b>        | 22.50 | 22.50 | 22.50 | 22.50 | 25.50 | 35.95 | 35.95 | 43.50 | 52.50 | —     | —     | —      | —      | —      |
| <b>K2 Yellow (Standard) #HOY( )</b>    | 16.50 | 16.50 | 16.50 | 16.50 | 19.50 | 29.95 | 29.95 | 37.50 | 44.95 | 56.95 | 97.50 | 104.95 | 64.50  | —      |
| <b>K2 Yellow (HMC) #HOYMC( )</b>       | 22.50 | 22.50 | 22.50 | 22.50 | 25.50 | 35.95 | 35.95 | 43.50 | 52.50 | 61.50 | —     | —      | —      | —      |
| <b>Orange (Standard) #HOO( )</b>       | 16.50 | 16.50 | 16.50 | 16.50 | 19.50 | 29.95 | 29.95 | 37.50 | 44.95 | 56.95 | 97.50 | 104.95 | 64.50  | 80.95  |
| <b>Orange (HMC) #HOOMC( )</b>          | 22.50 | 22.50 | 22.50 | 22.50 | 25.50 | 35.95 | 35.95 | 43.50 | 52.50 | 61.50 | —     | —      | —      | —      |
| <b>25A Red (Standard) #HOR( )</b>      | 16.50 | 16.50 | 16.50 | 16.50 | 19.50 | 29.95 | 29.95 | 37.50 | 44.95 | 56.95 | —     | 104.95 | 64.50  | 80.95  |
| <b>25A Red (HMC) #HORMC( )</b>         | 22.50 | 22.50 | 22.50 | 22.50 | 25.50 | 35.95 | 35.95 | 43.50 | 52.50 | 61.50 | —     | —      | —      | —      |
| <b>XO Yellow/Green (Std) #HOYG( )</b>  | 16.50 | 16.50 | 16.50 | 16.50 | 19.50 | 29.95 | 29.95 | 37.50 | 44.95 | 56.95 | 97.50 | 104.95 | 64.50  | 80.95  |
| <b>XO Yellow/Green (HMC) #HOYGC( )</b> | 22.50 | 22.50 | 22.50 | 22.50 | 25.50 | 35.95 | 35.95 | 43.50 | 52.50 | 61.50 | —     | —      | —      | —      |
| <b>X1 Green (Standard) #HOGR( )</b>    | 16.50 | 16.50 | 16.50 | 16.50 | 19.50 | 29.95 | 29.95 | 37.50 | 44.95 | 56.95 | 77.50 | 104.95 | 64.50  | 80.95  |
| <b>X1 Green (HMC) #HOGRMC( )</b>       | 22.50 | 22.50 | 22.50 | 22.50 | 25.50 | 35.95 | 35.95 | 43.50 | 52.50 | 61.50 | —     | —      | —      | —      |

*In the parenthesis insert the filter size. For example, a 58mm 81C FL Day Standard filter would be HOFLD58.*

*For Bay sizes insert just the letter B and the number. For example, 25A Red (HMC) in Bay 50 is HORMCB50.*

### Moose Filter-Warming Circular Polarizer

Collaboration between respected wildlife photographer and conservationist B. Moose Peterson of Wildlife Research Photography and Hoya has created a circular polarizing filter that uses 81A optical glass instead of the clear optical glass of a normal circular polarizer.

When using a camera with a split beam metering system (which is most of today's autofocus cameras), traditional linear polarizers will cause exposure errors do to their light absorption properties. Circular polarizers yield the same optical effect while not causing exposure problems with modern metering systems. For many years, polarizers have been used to remove reflections from non-metallic surfaces such as water and glass as well as being used to darken blue skies to increase contrast in scenic photography.

A side effect of both linear and circular polarizers is they "cool down" or make the over-all color balance of a scene slightly bluish. The addition of the 81A glass corrects the color temperature, bringing the scene back to the original 5500K for daylight film's color balance. The 81A glass creates a much more pleasing and "warm" color balance to the entire scene while the circular polarizer increases color contrast and reduces the effect of atmospheric haze.



### MOOSE - WARMING CIRCULAR POLARIZER

| Filter Size (mm)                                 | 46    | 49    | 52    | 55    | 58    | 62    | 67    | 72    | 77     | 82     | Bay 60 |
|--|-------|-------|-------|-------|-------|-------|-------|-------|--------|--------|--------|
| <b>Warm Circular Polarizer (Moose) #HOWCP( )</b> | 46.50 | 46.50 | 46.50 | 46.50 | 55.50 | 79.50 | 79.50 | 98.95 | 118.95 | 152.95 | 155.95 |



## COLOR EFFECT FILTERS

**Color-Spot:** A colored glass filter with a hole in its center. Available in yellow, green, red and gray. The central image stands out clearly while the background appears the color of the filter.



with Green Color-Spot & Spectral Cross



with Half Color

**Half Color:** Made by sandwiching a gelatin filter between two optical glass plates. Similar to Dual-Color except one-half is clear. Set in a rotating frame for added effectiveness. Color options are Pink, Yellow, Orange, Red, Emerald, Green, Brown, Blue, Violet, Light Gray, and Dark Gray.

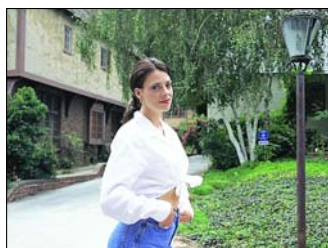

without filter



with Sepia

**Sepia:** These two filters give a nostalgic effect to otherwise ordinary color photographs. Sepia tones are produced across the whole image, as if taken many years ago in Black & White, having then discolored with age. Sepia B has a stronger effect than Sepia A.

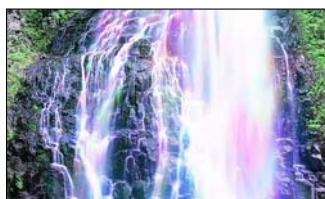

**Pop Filter Set:** Available in a set of three color filters: blue, green and red. Used individually or in combination, extremely original color effects can be obtained. Also great for multi-exposure creativity.

**Fantasy Color Set:** This set of three strongly colored filters in Moonlight Blue, Vivid Pink and Deep Mauve can be used to give a single color effect over the whole of a picture. Used in daylight, the Moonlight Blue filter gives the effect of a nighttime moonlit scene whilst the other two filters allow graphic and unusual images to be produced for special impact.



**Graduated Color:** Acrylic filters similar to half-color, except that color density gradually decreases near the center of the filter allowing emphasis of foregrounds or backgrounds. Mounted in a rotating frame. 7 colors are available: Pink, Yellow, Emerald, Tobacco, Blue, Mauve, Gray. Their color gradually fades out so the boundary between the colored and transparent sections will not become apparent even with the lens aperture stopped down.

**Dual-Color:** Available in three types: O/G (orange/green), Y/P (yellow/purple) and R/B (red/blue). Made by sandwiching gelatin filters between two pieces of optical glass, DUAL-COLOR is available in a variety of two-color combinations. Contrasting foreground and background, land and sea, are only a few of the fantastic possibilities.

**Tricolor:** Divided into three color sections (PARA: blue, yellow and pink, TRI: blue, green and red) for imaginative three tone effects. Available in two types: Parallel and Triangle. The effect varies depending on the length of the lens used and the aperture.



with Tricolor



R/B Dual-Color



O/G Dual-Color ▶

**PL-Color:** Available in four types: B(blue), Y(yellow), O(orange) and R(red). A combination of gray and colored polarizing filters. Any color from gray to the full color of the filter can be obtained by rotating the filter frame.

**Vario PL-Color:** Available in five types: Y/B, Y/G, Y/R, R/B, and R/G. This filter is a combination of one gray polarizing filter and two colored polarizing filters. The color can be varied by rotating the filter frames. Many color possibilities help create new emotional effects never seen before.

**Pol-Conversion:** This unique filter combines the advantages of a polarizer with an 85B color conversion filter allowing tungsten film to be shot under daylight conditions.



## SOFT DIFFUSED EFFECT FILTERS



**Center-Spot:**  
A close-up lens with a hole in the center. The periphery of the picture is rendered a delicate, soft-focus effect while the central image is sharply focused.

◀ Center-Spot

**Sand Screen and Soft Screen Soft Spots:** Both have a clear center spot which makes the central image stand out clearly. SAND SCREEN has a smoky appearance while SOFT SCREEN has an irregularly uneven surface. With SOFT-SPOT, the size of the clear part in the center of the picture varies depending on the lens and aperture used.



with Sand Screen



with Soft Screen

**Misty-Spot:** Available in four types: Gradual, Breeze, Windmill and Halo. They have a sharp central image with a pleasant blurring of the outer field. With Gradual, blurring that appears to emanate from the center. Breeze has an unidirectional streaky blurring of background. With Windmill, blurring that appears to swirl about the center, and with Halo, blur that appears to radiate from a single point at the edge of the field.



Misty-Spot Windmill



Misty-Spot Halo



Misty-Spot Gradual

**Rainbow-Spot:** Made of glass, and provided with rotating frames. 1,270 ultra-fine parallel grooves per inch pick up and diffract each tiny point of light into a rainbow of color.



**Fog Filter:**

Lightly veils the entire picture in white. Available individually or as a set of two: FOG(A) and FOG(B) with 'B' having a stronger effect than 'A'. Both can be used together to produce an

effect similar to dense fog. The effect can be varied by changing the aperture of the lens, but stopping down too far will reduce the effect.

**Diffuser, Duto:**

Both are diffusion type filters, but DIFFUSER gives a soft-focus effect due to its irregularly uneven surface while DUTO has fine concentric lines etched on its surface. The center of the picture is usually sharp with DUTO but DIFFUSER gives an overall soft-focus effect. Both are particularly effective in portraiture and commercial photography

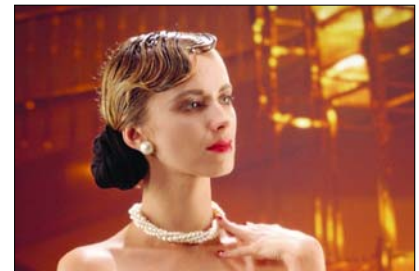

with Diffuser

**Softener (A and B):**

A filter randomly arranging minute lens shaped like drops of water on the surface of a acrylic board, scatters the light and results in a soft focus. It creates a picture with a clear focus and a soft gradation. This effect is especially evident with an object with a point light source. Color reproduction is easy, and there is no need for exposure adjustment.



with Softner (A)

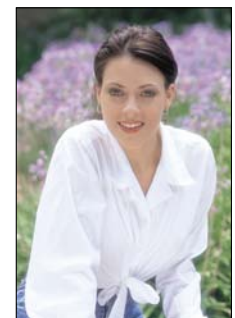

with Softner (B)

**Spectral Cross:** An overall soft-focus effect is obtained for portraits, etc., outdoors with direct lighting, while back lighting or point light sources at night create heightened cross effects. The effect is somewhat softer than with cross screen and diffraction of the light produces a slight amount of flare. A filter made by sandwiching black gauze-like fiber between two pieces of colorless, transparent optical glass in a rotating frame. Producing both soft focus and cross effects.

## COLOR EFFECT & SOFT DIFFUSED EFFECT FILTERS

| COLOR EFFECTS & SOFT DIFFUSED FILTERS         |       |       |       |       |       |       |       |       |       |       |
|---|-------|-------|-------|-------|-------|-------|-------|-------|-------|-------|
| Filter Size (mm)                              | 46    | 49    | 52    | 55    | 58    | 62    | 67    | 72    | 77    | 82    |
| <b>Color Spot Yellow</b> #HOCSY( )            | —     | 35.95 | 39.95 | 35.95 | 40.50 | 50.95 | 50.95 | 59.95 | 74.95 | —     |
| <b>Color Spot Green</b> #HOCSGR( )            | —     | 35.95 | 39.95 | 35.95 | 40.50 | 50.95 | 50.95 | 59.95 | 74.95 | —     |
| <b>Color Spot Red</b> #HOCSR( )               | —     | 35.95 | 39.95 | 35.95 | 40.50 | 50.95 | 50.95 | 59.95 | 74.95 | —     |
| <b>Color Spot Gray</b> #HOCSG( )              | —     | 35.95 | 39.95 | 35.95 | 40.50 | 50.95 | 50.95 | 59.95 | 74.95 | —     |
|   |       |       |       |       |       |       |       |       |       |       |
| <b>Half Color Pink</b> #HOHCP( )              | —     | 32.95 | 32.95 | 32.95 | 38.95 | 41.95 | 44.95 | 56.95 | 64.50 | 76.50 |
| <b>Half Color Yellow</b> #HOHCY( )            | —     | 32.95 | 32.95 | 32.95 | 38.95 | 41.95 | 44.95 | 56.95 | 64.50 | 76.50 |
| <b>Half Color Orange</b> #HOHCO( )            | —     | 32.95 | 32.95 | 32.95 | 38.95 | 41.95 | 44.95 | 56.95 | 64.50 | 76.50 |
| <b>Half Color Red</b> #HOHCR( )               | —     | 32.95 | 32.95 | 32.95 | 38.95 | 41.95 | 44.95 | 56.95 | 64.50 | 76.50 |
| <b>Half Color Green</b> #HOHCGR( )            | —     | 32.95 | 32.95 | 32.95 | 38.95 | 41.95 | 44.95 | 56.95 | 64.50 | 76.50 |
| <b>Half Color Brown</b> #HOHCBR( )            | —     | 32.95 | 32.95 | 32.95 | 38.95 | 41.95 | 44.95 | 56.95 | 64.50 | 76.50 |
| <b>Half Color Blue</b> #HOHCBL( )             | —     | 32.95 | 32.95 | 32.95 | 38.95 | 41.95 | 44.95 | 56.95 | 64.50 | 76.50 |
| <b>Half Color Violet</b> #HOHCV( )            | —     | 32.95 | 32.95 | 32.95 | 38.95 | 41.95 | 44.95 | 56.95 | 64.50 | 76.50 |
| <b>Half Color Light Gray</b> #HOHCLG( )       | —     | 32.95 | 32.95 | 32.95 | 38.95 | 41.95 | 44.95 | 56.95 | 64.50 | 76.50 |
| <b>Half Color Dark Gray</b> #HOHCDG( )        | —     | 32.95 | 32.95 | 32.95 | 38.95 | 41.95 | 44.95 | 56.95 | 64.50 | 76.50 |
|   |       |       |       |       |       |       |       |       |       |       |
| <b>Sepia A</b> #HOSA( )Q                      | —     | 37.50 | 37.50 | 37.50 | 39.95 | 49.95 | 49.95 | 57.95 | 59.95 | —     |
| <b>Sepia B</b> #HOSB( )Q                      | —     | 37.50 | 37.50 | 37.50 | 39.95 | 49.95 | 49.95 | 57.95 | 59.95 | —     |
|   |       |       |       |       |       |       |       |       |       |       |
| <b>Pop Filter Set</b> #HOPFS( )               | —     | 74.95 | 74.95 | 74.95 | 85.95 | —     | —     | —     | —     | —     |
|   |       |       |       |       |       |       |       |       |       |       |
| <b>Fantasy Color Set</b> #HOFCS( )            | —     | 82.95 | 89.95 | 89.95 | 97.50 | —     | —     | —     | —     | —     |
|   |       |       |       |       |       |       |       |       |       |       |
| <b>Graduated Color-Emerald</b> #HOGE( )       | —     | 20.95 | 20.95 | 20.95 | 32.50 | —     | —     | —     | —     | —     |
| <b>Graduated Color-Yellow</b> #HOGY( )        | —     | 20.95 | 20.95 | 20.95 | 32.50 | —     | —     | —     | —     | —     |
| <b>Graduated Color-Blue</b> #HOGBL( )         | —     | 20.95 | 20.95 | 20.95 | 32.50 | —     | —     | —     | —     | —     |
| <b>Graduated Color-Pink</b> #HOGP( )          | —     | 20.95 | 20.95 | 20.95 | 32.50 | —     | —     | —     | —     | —     |
| <b>Graduated Color-Mauve</b> #HOGM( )         | —     | 20.95 | 20.95 | 20.95 | 32.50 | —     | —     | —     | —     | —     |
| <b>Graduated Color-Tobacco</b> #HOGT( )       | —     | 20.95 | 20.95 | 20.95 | 32.50 | —     | —     | —     | —     | —     |
| <b>Graduated Color-Gray</b> #HOGG( )          | —     | 20.95 | 20.95 | 20.95 | 32.50 | —     | —     | —     | —     | —     |
|   |       |       |       |       |       |       |       |       |       |       |
| <b>Tri-Color (Blue/Red/Green)</b> #HOTCT( )   | 47.95 | 47.95 | 47.95 | 47.95 | 56.95 | 64.50 | 64.50 | 73.50 | —     | —     |
| <b>Tri-Color (Blue/Yellow/Pink)</b> #HOTCP( ) | 47.95 | 47.95 | 47.95 | 47.95 | 56.95 | 64.50 | 64.50 | 73.50 | —     | —     |
|   |       |       |       |       |       |       |       |       |       |       |
| <b>Dual-Color (Orange/Green)</b> #HODCOG( )   | —     | 29.95 | 29.95 | 29.95 | 34.95 | —     | —     | —     | —     | —     |
| <b>Dual-Color (Red/Blue)</b> #HODCRB( )       | —     | 29.95 | 29.95 | 29.95 | 34.95 | —     | —     | —     | —     | —     |
| <b>Dual-Color (Yellow/Purple)</b> #HODCYP( )  | —     | 29.95 | 29.95 | 29.95 | 34.95 | —     | —     | —     | —     | —     |

## COLOR EFFECT & SOFT DIFFUSED EFFECT FILTERS

| COLOR EFFECTS & SOFT DIFFUSED FILTERS    |    |       |       |       |       |       |       |       |        |       |
|--|----|-------|-------|-------|-------|-------|-------|-------|--------|-------|
| Filter Size (mm)                         | 46 | 49    | 52    | 55    | 58    | 62    | 67    | 72    | 77     | 82    |
| PL-Color (Orange) #HOPO( )               | —  | 58.50 | 58.50 | 58.50 | 64.50 | 79.50 | 79.50 | 94.50 | —      | —     |
| PL-Color (Yellow) #HOPY( )               | —  | 58.50 | 58.50 | 58.50 | 64.50 | 79.50 | 79.50 | 94.50 | —      | —     |
| PL-Color (Blue) #HOPBL( )                | —  | 58.50 | 58.50 | 58.50 | 64.50 | 79.50 | 79.50 | 94.50 | —      | —     |
| PL-Color (Red) #HOPR( )                  | —  | 58.50 | 58.50 | 58.50 | 64.50 | 79.50 | 79.50 | 94.50 | —      | —     |
|  |    |       |       |       |       |       |       |       |        |       |
| Vario PL-Color (Red/Blue) #HOVPRB( )     | —  | 59.95 | 59.95 | 59.95 | 64.50 | —     | —     | —     | —      | —     |
| Vario PL-Color (Red/Green) #HOVPRG( )    | —  | 59.95 | 59.95 | 59.95 | 64.50 | —     | —     | —     | —      | —     |
| Vario PL-Color (Yellow/Blue) #HOVPYB( )  | —  | 59.95 | 59.95 | 59.95 | 64.50 | —     | —     | —     | —      | —     |
| Vario PL-Color (Yellow/Green) #HOVPYG( ) | —  | 59.95 | 59.95 | 59.95 | 64.50 | —     | —     | —     | —      | —     |
| Vario PL-Color (Yellow/Red) #HOVPYR( )   | —  | 59.95 | 59.95 | 59.95 | 64.50 | —     | —     | —     | —      | —     |
|  |    |       |       |       |       |       |       |       |        |       |
| Pol-Conversion #HOPC( )                  | —  | 44.95 | 44.95 | 44.95 | 54.95 | 73.50 | 73.50 | 97.50 | 104.95 | —     |
|  |    |       |       |       |       |       |       |       |        |       |
| Center-Spot #HOCS( )                     | —  | 20.95 | 20.95 | 20.95 | 22.50 | 29.95 | 29.95 | 38.95 | —      | —     |
|  |    |       |       |       |       |       |       |       |        |       |
| Sand Screen & Soft Screen Set #HOSSS( )  | —  | 32.95 | 32.95 | 32.95 | 37.50 | 49.50 | 49.50 | 58.50 | 64.50  | —     |
|  |    |       |       |       |       |       |       |       |        |       |
| Misty-Spot Breeze #HOMSB( )              | —  | 22.50 | 22.50 | 22.50 | —     | —     | —     | —     | —      | —     |
| Misty-Spot Gradual #HOMSG( )             | —  | 22.50 | 22.50 | 22.50 | —     | —     | —     | —     | —      | —     |
| Misty-Spot Halo #HOMSH( )                | —  | 22.50 | 22.50 | 22.50 | —     | —     | —     | —     | —      | —     |
| Misty-Spot Windmill #HOMSW( )            | —  | 22.50 | 22.50 | 22.50 | —     | —     | —     | —     | —      | —     |
|  |    |       |       |       |       |       |       |       |        |       |
| Rainbow-Spot #HORS( )                    | —  | 47.95 | 47.95 | 47.95 | 56.95 | 64.50 | 64.50 | 73.50 | —      | —     |
|  |    |       |       |       |       |       |       |       |        |       |
| Fog A #HOFA( )                           | —  | 22.50 | 22.50 | 22.50 | 23.95 | —     | —     | —     | —      | —     |
| Fog B #HOFB( )                           | —  | 22.50 | 22.50 | 22.50 | 23.95 | —     | —     | —     | —      | —     |
| Fog Set (A&B) #HOFS( )                   | —  | 40.50 | 40.50 | 40.50 | 50.95 | 61.50 | 61.50 | 73.50 | 91.50  | —     |
|  |    |       |       |       |       |       |       |       |        |       |
| Diffuser #HOD( )                         | —  | 16.50 | 16.50 | 16.50 | 19.50 | 29.95 | 29.95 | 37.50 | 44.95  | 56.95 |
| DUTO                                     | —  | —     | —     | —     | —     | —     | —     | —     | —      | —     |
|  |    |       |       |       |       |       |       |       |        |       |
| Softener A #HOSA( )                      | —  | 28.50 | 28.50 | 28.50 | 34.50 | 44.95 | 44.95 | 52.50 | 52.50  | —     |
| Softener B #HOSB( )                      | —  | 28.50 | 28.50 | 28.50 | 34.50 | 44.95 | 44.95 | 52.50 | 52.50  | —     |
|  |    |       |       |       |       |       |       |       |        |       |
| Spectral Cross #HOSC( )                  | —  | 31.50 | 31.50 | 31.50 | 32.95 | —     | —     | —     | —      | —     |

In the parenthesis insert the filter size. For example, a 62mm Fog B filter would be HOFB62.



## SPECIAL EFFECTS FILTERS

**Half NDx4:** One half of this filter is NDx4 Neutral Density and the other half is clear, with a soft boundary between the two. It is used to control bright/dark contrast, by reducing half the shot by 2 stops. Particularly useful in landscape photography, the rotating mount allows bright skies to be easily controlled for dramatic effect.



with Multivision 4F

with Multivision 6F



**Multivision:** Available in five types: 3PF, 3F, 5F, 6F, and 6PF. Made of optical glass precisely cut into a variety of facets, MULTIVISION helps create exotic, fantastic compositions of color patterns and combinations. Effect is strongest with a relatively dark background and at larger apertures. The multi-images appear closer together with wide-angle lenses and farther apart with telephoto lenses.

**Vari-Multivision:** Two 2-face MULTIVISIONS set in independent rotating frames. Creates multi-images that can be varied from 2- to 4-face by rotating the frames.

with 4F

Vari-Multivision

with Color Multivision



**Color-Multivision:** Available in two types: (3F) with three faces in blue, green and red; and (5F) with five faces evenly divided into green and orange. These filters produce the dynamic professional color multi-images often seen in TV or commercial photography. Results are striking with either still or movie cameras.

**Close-up:** Available in sets of +1, +2, and +4 diopters for close-up photography. Depth-of-field is shallow so use as small an aperture as possible. Close-ups offer a world of new creativity.

### Macro Close-up:

A lens of 2-element, 2-group construction and a +10 diopter rating. Resolution is outstanding and focusing is possible at 10cm for super close-ups of insects, flowers and other small objects. The magnification is about 1:2 with a 50mm standard lens (35mm camera), roughly equivalent to a 100mm telephoto lens. The lens should be stopped down as much as possible to get maximum depth-of-field.



### Pol-Fader:

A combination of two gray polarizing filters set in independently rotating frames. Rotating the frames varies the amount of light passed. Useful with exceptionally strong light sources, such as in solar



photography, scientific applications, etc. Useful with movie cameras for fadeouts.

**Infrared:** Used for photography with infrared films. Infrared film is also sensitive to ultraviolet rays and the shorter wavelengths of the visible spectrum so it is necessary to filter out all but the infrared rays. R72 passes only infrared rays above 720nm; RM90 passes only that above 900nm. Often used in crime detection, medical photography, detection of distribution of vegetation, etc. In ordinary photography with infrared film or infrared color film, the Y(K2), O(G), R(25A) and other filters can also be used to change the contrast or color effect.

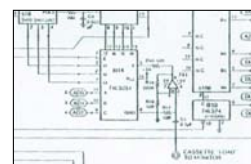

## SPECIAL EFFECTS FILTERS



**Split-Field:** One-half of a close-up lens with the other half open. One-half of the picture receives a close-up effect while the other half is normal. Both very close and far subjects can be in focus at the same time. Or one-half of the picture can be out of focus for special effects.

**Dual-Image:** One half of dual-image is transparent while the other is black. Used for producing special effects by taking double exposures. For example, the same person can be photographed on both sides of the same picture. When taking such photographs with this filter, refer to the instruction manual of your camera, and the use of tripod is recommended.



with Star-Eight

with Cross Screen

### 4x Cross Screen, Star-Six, Star-Eight:

Cross Screen adds a dramatic four-cross flare to very bright areas, giving a soft-focus effect. Ideal for photographs of ladies wearing jewellery or other objects with strong reflections. Star-Six (6-pointed light flares) and Star-Eight (8-pointed light flares) can also be used for a variety of effects.

**Variocross:** Two colorless glass plates with etched parallel lines on each surface and set in independent rotating frames. By rotating these frames, the effect can be varied to produce any desired expression for any highly reflective scene.



**NDx2, NDx4, NDx8:** In conditions of extreme light intensity, such as sunshine on snowy mountains or on the beach, or when using a camcorder, ND (Neutral Density) filters are recommended as essential. Neutral Density filters are often ignored by photographers, but they have several uses and offer the possibility to achieve otherwise unachievable results. ND filters appear grey and reduce the amount of light reaching the film, they have no effect on color balance.



with NDx8

### They have four main uses:

- To enable slow shutter speeds to be used, especially with fast films, to record movement in subjects such as waterfalls, clouds, cars, seas etc.
- To decrease depth of field by allowing wider apertures to be used, which helps separate subjects from their background.
- To decrease the effective ISO of high speed film (ie: above ISO400) and allow it to be used outdoors in blight situations.
- To allow cine and video cameras (which have fixed shutter speeds) to film subjects such as snow, sand or other bright scenes which would normally cause over-exposure.



without filter



with Center ND

**Center ND (x2):** This filter combines two curved optics, one of which is neutral density and the other is clear. This gives the effect of a gradual fade towards the edges, with a difference of 1 stop from centre to edge. It is used primarily to remove vignetting which occurs with large format cameras when using wide-angle lenses, to give an evenly illuminated shot.

**NDx400:** Photographing solar eclipses and ultra-bright light sources can be extremely dangerous. This filter reduces light values by 9 stops to less than 1/500th of its original intensity and allows safe photography. It can also be used to achieve super slow shutter speeds in daylight to render moving subjects invisible.

## SPECIAL EFFECTS FILTERS

FILTERS

386

| SPECIAL EFFECTS FILTERS         |       |       |       |       |       |        |        |        |        |       |       |        |        |        |
|---------------------------------|-------|-------|-------|-------|-------|--------|--------|--------|--------|-------|-------|--------|--------|--------|
| Filter Size (mm)                | 46    | 49    | 52    | 55    | 58    | 62     | 67     | 72     | 77     | 82    | 86    | 95     | Bay 50 | Bay 60 |
| Split Field #HOSF( )            | —     | 32.95 | 32.95 | 32.95 | 35.95 | 38.95  | 38.95  | 49.50  | —      | —     | —     | —      | —      | —      |
| Dual Image #HODI( )             | —     | 31.50 | 31.50 | 31.50 | 34.50 | 43.50  | 43.50  | 52.50  | 62.95  | —     | —     | —      | —      | —      |
| 4x Cross Screen #HOCs4( )       | 16.50 | 16.50 | 16.50 | 16.50 | 19.50 | 29.95  | 29.95  | 37.50  | 44.95  | 56.95 | —     | —      | 64.50  | 80.95  |
| 6-Point Star #HOS6( )           | —     | 22.50 | 22.50 | 22.50 | 25.50 | 37.50  | 37.50  | 43.50  | 49.50  | 59.95 | —     | —      | —      | —      |
| 8-Point Star #HOS8( )           | —     | 22.50 | 22.50 | 22.50 | 25.50 | 37.50  | 37.50  | 43.50  | 49.50  | 59.95 | —     | —      | —      | —      |
| Variocross #HOVC( )             | —     | 50.95 | 50.95 | 50.95 | 50.95 | —      | —      | —      | —      | —     | —     | —      | —      | —      |
| Pol-Fader #HOPF( )              | —     | 47.95 | 47.95 | 47.95 | 53.95 | —      | —      | —      | —      | —     | —     | —      | —      | —      |
| NDx2 (Standard) #HOND2( )       | 16.50 | 16.50 | 16.50 | 16.50 | 19.50 | 29.95  | 29.95  | 37.50  | 44.95  | 56.95 | 97.50 | 104.95 | 64.50  | 80.95  |
| NDx2 (HMC) #HOND2MC( )          | 22.50 | 22.50 | 22.50 | 22.50 | 25.50 | 34.95  | 34.95  | 43.50  | 52.50  | 61.50 | —     | —      | —      | —      |
| NDx2 (Ultra-Thin) #HOND2U( )    | —     | —     | —     | —     | 44.95 | 39.95  | 39.95  | 49.50  | 52.50  | —     | —     | —      | —      | —      |
| NDx4 (Standard) #HOND4( )       | 16.50 | 16.50 | 16.50 | 16.50 | 19.50 | 29.95  | 29.95  | 37.50  | 44.95  | 56.95 | 97.50 | 104.95 | 64.50  | 80.95  |
| NDx4 (HMC) #HOND4MC( )          | 22.50 | 22.50 | 22.50 | 22.50 | 25.50 | 34.95  | 34.95  | 43.50  | 52.50  | 61.50 | —     | —      | —      | —      |
| NDx4 (Ultra-Thin) #HOND4U( )    | —     | —     | —     | —     | 31.50 | 39.95  | 39.95  | 49.50  | 52.50  | —     | —     | —      | —      | —      |
| NDx8 (Standard) #HOND8( )       | 16.50 | 16.50 | 16.50 | 16.50 | 19.50 | 29.95  | 29.95  | 37.50  | 44.95  | 56.95 | 97.50 | 104.95 | 64.50  | 80.95  |
| NDx8 (HMC) #HOND8MC( )          | 22.50 | 22.50 | 22.50 | 22.50 | 25.50 | 34.95  | 34.95  | 43.50  | 52.50  | 61.50 | —     | —      | —      | —      |
| NDx8 (Ultra-Thin) #HOND8U( )    | —     | —     | —     | —     | 44.95 | 39.95  | 39.95  | 49.50  | 52.50  | —     | —     | —      | —      | —      |
| Center NDx2 (HMC) #HOCNDMC( )   | —     | —     | —     | —     | —     | 209.95 | 254.95 | 299.95 | —      | —     | —     | —      | —      | —      |
| NDx400 (HMC) #HOND400MC( )      | —     | 67.50 | 67.50 | 67.50 | 79.95 | 112.50 | 112.50 | 128.95 | 146.95 | —     | —     | —      | —      | —      |
| Half NDx4 #HOHND4( )            | —     | 54.95 | 54.95 | 54.95 | 62.95 | —      | —      | —      | —      | —     | —     | —      | —      | —      |
| Multivision 3PF #HOMV3PF( )     | —     | 49.50 | 49.50 | 49.50 | 55.50 | 73.50  | 73.50  | 89.95  | 97.50  | —     | —     | —      | —      | —      |
| Multivision 3F #HOMV3F( )       | —     | 49.50 | 49.50 | 49.50 | 55.50 | 73.50  | 73.50  | 89.95  | 97.50  | —     | —     | —      | —      | —      |
| Multivision 5F #HOMV5F( )       | —     | 55.50 | 55.50 | 55.50 | 61.50 | 89.95  | 89.95  | 97.50  | 113.95 | —     | —     | —      | —      | —      |
| Multivision 6F #HOMV6F( )       | —     | 59.95 | 59.95 | 59.95 | 77.95 | 94.50  | 94.50  | 118.95 | 128.95 | —     | —     | —      | —      | —      |
| Multivision 6PF #HOMV6PF( )     | —     | —     | 59.95 | 22.50 | 77.95 | 94.50  | 94.50  | 118.95 | 128.95 | —     | —     | —      | —      | —      |
| Vari-Multivision #HOVMV( )      | —     | 74.95 | 74.95 | 74.95 | —     | —      | —      | —      | —      | —     | —     | —      | —      | —      |
| Vari-Multivision 3F #HOVMV3F( ) | —     | —     | —     | —     | —     | —      | —      | —      | —      | —     | —     | —      | —      | —      |
| Vari-Multivision 5F #HOVMV5F( ) | —     | —     | —     | —     | —     | —      | —      | —      | —      | —     | —     | —      | —      | —      |



## SPECIAL EFFECTS FILTERS

| SPECIAL EFFECTS FILTERS               |        |        |        |        |        |        |        |        |        |       |    |    |
|---------------------------------------|--------|--------|--------|--------|--------|--------|--------|--------|--------|-------|----|----|
| Filter Size (mm)                      | 46     | 49     | 52     | 55     | 58     | 62     | 67     | 72     | 77     | 82    | 86 | 95 |
| Close-Up (+1, +2, +4) #HOCUS( )       | 37.50  | 37.50  | 37.50  | 37.50  | 44.95  | 62.95  | 62.95  | 80.95  | 89.95  | —     | —  | —  |
| Close-Up (+1, +2, +4) HMC #HOCUSMC( ) | 56.95  | 56.95  | 56.95  | 56.95  | 64.50  | 85.50  | 85.50  | —      | —      | —     | —  | —  |
| Macro Close-Up (+10) Lens #HOMCU( )   | —      | 80.95  | 80.95  | 80.95  | —      | —      | —      | —      | —      | —     | —  | —  |
| 6-Point Star #HOS6( )                 | —      | 22.50  | 22.50  | 22.50  | 25.50  | 37.50  | 37.50  | 43.50  | 49.50  | 59.95 | —  | —  |
| 8-Point Star #HOS8( )                 | —      | 22.50  | 22.50  | 22.50  | 25.50  | 37.50  | 37.50  | 43.50  | 49.50  | 59.95 | —  | —  |
| RM72 Infrared #HOIR72( )              | 40.50  | 40.50  | 40.50  | 40.50  | 47.95  | 80.95  | 80.95  | 263.95 | 283.50 | —     | —  | —  |
| RM90 Infrared #HOIR90( )              | 253.50 | 253.50 | 253.50 | 253.50 | 308.95 | 359.95 | 359.95 | 404.95 | 454.95 | —     | —  | —  |

In the parenthesis insert the filter size. For example, a 49mm 6-Point Star filter would be HOS649.

### Enhancing Filters

**Enhancer (Intensifier):** Also known as a 'didymium' filter, this is used to enhance red, orange and brown subjects to give more color saturation and contrast, while having very little effect on other colors. It can be used in many situations such as architecture where certain building features need emphasising, or for landscapes to enhance foliage and rocky features.



without filter

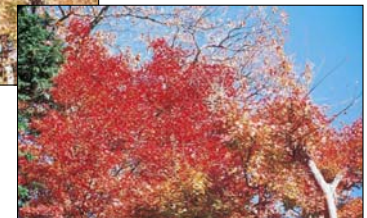

with Enhancer

**Blue Intensifier:** Intensifies and enhances colors in the blue region of the spectrum without adversely affecting other colors. It is particularly useful for brightening seascapes and pale or cloudy skies, but also suitable for when, due to the sun's direction, polarizing filters are ineffective in increasing the saturation of a blue sky. Combination use with PRO 1 UV(0) or Circular Polarizer is recommended for increased contrast and sharpness.



without filter



with Blue Intensifier

**Green Field (Intensifier):** Intensifies and enhances colors in the green region of the spectrum without adversely affecting other colors. It is particularly useful for improving outdoor shots which include nature, flowers, landscapes and water. It can also be used as permanent lens protection filter. Combination use with PRO 1 UV(0) or Circular Polarizer is recommended for increased contrast and sharpness.

**Portrait:** Enhances pink and reduces both yellow and orange to make human skin tones more vivid and clear. Combination use with PRO 1UV(0) is ideal when shooting under fine blue skies.

| ENHANCING FILTERS         |    |       |       |       |       |       |       |       |       |    |    |    |
|---------------------------|----|-------|-------|-------|-------|-------|-------|-------|-------|----|----|----|
| Filter Size (mm)          | 46 | 49    | 52    | 55    | 58    | 62    | 67    | 72    | 77    | 82 | 86 | 95 |
| Enhancing #HOE( )         | —  | 35.95 | 35.95 | 35.95 | 44.95 | 58.50 | 58.50 | 64.50 | 77.95 | —  | —  | —  |
| Blue Intensifier #HOBI( ) | —  | 35.95 | 35.95 | 35.95 | 44.95 | 58.50 | 58.50 | 64.50 | 77.95 | —  | —  | —  |
| Green Field #HOGFI( )     | —  | 35.95 | 35.95 | 35.95 | 44.95 | 58.50 | 58.50 | 64.50 | 77.95 | —  | —  | —  |
| Portrait #HOCSG( )        | —  | 35.95 | 35.95 | 35.95 | 40.50 | 50.95 | 50.95 | 59.95 | 79.95 | —  | —  | —  |



## GEL FILTERS

Kodak gel filters are made by dissolving suitable organic dyes in liquid gelatin and coating the proper amount of the solution onto prepared glass. After the coating is dry, the gelatin film is stripped from the support material and coated with lacquer. Each filter is then standardized for spectral transmittance and total transmittance by special instruments which apply an optical form of limit gauge to these characteristics. Available in 75mm (3x3") or 100mm (4x4") squares, they have a uniform thickness which gives them an excellent optical quality. Ideal for precise work where little effect on definition and no increase in length of the optical path can be tolerated.

| ULTRA VIOLET ABSORBING FILTERS |  |         |       |         |       |
|--------------------------------|--|---------|-------|---------|-------|
| #                              | Filter Description   | 3x3     |       | 4x4     |       |
|                                |  | Item #  | Price | Item #  | Price |
| 2A                             | <b>Pale Yellow:</b> Absorbs ultraviolet radiation  | KO2A33  | 23.95 | KO2A44  | 34.95 |
| 2B                             | <b>Pale Yellow:</b> Absorbs ultraviolet radiation, slightly less than #2A                  | KO2B33  | 23.95 | KO2B44  | 34.95 |
| 2E                             | <b>Pale Yellow:</b> Absorbs more ultraviolet radiation than #2A                            | KO2E33  | 23.95 | KO2E44  | 34.95 |
| COLOR FILTERS                  |  |         |       |         |       |
| 3                              | <b>Light Yellow:</b> Absorbs excessive sky blue  | KO333   | 55.95 | KO344   | 83.95 |
| 8                              | <b>Yellow:</b> Transmits less blue than #3   | KO833   | 23.95 | KO844   | 34.95 |
| 9                              | <b>Deep Yellow:</b> More dramatic effect than #8   | KO933   | 55.95 | KO944   | 83.95 |
| 11                             | <b>Yellowish-Green:</b> Corrects pan film rendition to match tungsten impression of scene  | KO1133  | 23.95 | KO1144  | 34.95 |
| 12                             | <b>Deep Yellow:</b> Minus blue filter (see #32 for minus-green and #44A for minus-red)     | KO1233  | 23.95 | KO1244  | 34.95 |
| 15                             | <b>Deep Yellow:</b> Darkens sky in landscape photography                                   | KO1533  | 23.95 | KO1544  | 34.95 |
| 16                             | <b>Yellow-Orange:</b> Greater over-correction of sky than #15                              | KO1633  | 23.95 | KO1644  | 34.95 |
| 21                             | <b>Orange:</b> Contrast filter for blue and blue-green absorption                          | KO2133  | 55.95 | KO2144  | 83.95 |
| 22                             | <b>Deep Orange:</b> Contrast filter, greater effect than #21                               | KO2233  | 23.95 | KO2244  | 34.95 |
| 24                             | <b>Red</b>   | KO2433  | 19.95 | KO2444  | 33.95 |
| 25                             | <b>Red Tricolor:</b> Color separation work, tricolor printing, and infrared photography.   | KO2533  | 23.95 | KO2544  | 34.95 |
| 26                             | <b>Red</b>   | KO2633  | 55.95 | KO2644  | 83.95 |
| 29                             | <b>Red:</b> Color separation with #47 and #61 and tricolor printing work.                  | KO2933  | 23.95 | KO2944  | 34.95 |
| 32                             | <b>Magenta:</b> Minus-green (#12 is minus-blue, #44A is minus-red)                         | KO3233  | 55.95 | KO3244  | 83.95 |
| 34A                            | <b>Violet:</b> For minus-green and plus-blue separation                                    | KO34A33 | 55.95 | KO34A44 | 83.95 |
| 38A                            | <b>Blue:</b> Absorbs red, some UV and green light  | KO38A33 | 55.95 | KO38A44 | 83.95 |
| 44                             | <b>Light Blue-Green:</b> Minus-red filter with much UV absorption                          | KO4433  | 55.95 | KO4444  | 83.95 |
| 44A                            | <b>Light Blue-Green:</b> Minus-red (#12 is minus-blue, and #32 is minus-green)             | KO44A33 | 55.95 | KO44A44 | 83.95 |
| 47                             | <b>Blue Tricolor:</b> Color separation work with #29 and #61                               | KO4733  | 23.95 | KO4744  | 34.95 |
| 47A                            | <b>Light Blue:</b> Exciting fluorescein dyes in medical applications                       | KO47A33 | 55.95 | KO47A44 | 83.95 |
| 47B                            | <b>Deep Blue Tricolor:</b> Color separation and tricolor work                              | KO47B33 | 55.95 | KO47B44 | 83.95 |
| 58                             | <b>Green Tricolor:</b> Color separation and tricolor printing                              | KO5833  | 23.95 | KO5844  | 34.95 |
| 61                             | <b>Deep Green Tricolor.</b> Tricolor work with #29 and #47                                 | KO6133  | 55.95 | KO6144  | 83.95 |
| 87                             | Visibly opaque infrared filter   | KO8733  | 55.95 | KO8744  | 83.95 |
| 87C                            | Visibly opaque infrared filter   | KO87C33 | 55.95 | KO87C44 | 83.95 |
| 89B                            | Visibly opaque infrared filter, especially for aerial.                                     | KO89B33 | 55.95 | KO89B44 | 83.95 |
| 90                             | Dark grayish amber   | KO9033  | 23.95 | KO9044  | 34.95 |
| 92                             | Red for color densitometry.  | KO9233  | 55.95 | KO9244  | 83.95 |
| 98                             | <b>Blue:</b> Equivalent to #47B plus # 2B filter.  | KO9833  | 55.95 | KO9844  | 83.95 |
| 99                             | <b>Green:</b> Equivalent to #61 plus #16 filter.   | KO9933  | 23.95 | KO9944  | 34.95 |
| 102                            | <b>Yellow-Green.</b> Converts barrier-layer photocell response to eye luminosity response. | KO10233 | 55.95 | KO10244 | 83.95 |
| 106                            | <b>Amber:</b> Converts an S-4 type photocell response to the eye-luminosity response.      | KO10633 | 55.95 | KO10644 | 83.95 |

## GEL FILTERS

Neutral density filters are used to reduce the intensity of light by a definite ratio, without affecting the tonal rendition of colors. Neutrality is superb only in visible spectrum.

| NEUTRAL DENSITY (ND) FILTERS |           |       |           |       |
|------------------------------|-----------|-------|-----------|-------|
| Filter Description           | 3x3       |       | 4x4       |       |
|                              | Item #    | Price | Item #    | Price |
| ND 0.1 (80% transmission)    | KOND.133  | 46.95 | KOND.144  | 72.95 |
| ND 0.2 (63% transmission)    | KOND.233  | 46.95 | KOND.244  | 72.95 |
| ND 0.3 (50% transmission)    | KOND.333  | 46.95 | KOND.344  | 72.95 |
| ND 0.4 (40% transmission)    | KOND.433  | 46.95 | KOND.444  | 72.95 |
| ND 0.5 (32% transmission)    | KOND.533  | 46.95 | KOND.544  | 72.95 |
| ND 0.6 (25% transmission)    | KOND.633  | 46.95 | KOND.644  | 72.95 |
| ND 0.7 (20% transmission)    | KOND.733  | 46.95 | KOND.744  | 72.95 |
| ND 0.8 (16% transmission)    | KOND.833  | 46.95 | KOND.844  | 72.95 |
| ND 0.9 (13% transmission)    | KOND.933  | 46.95 | KOND.944  | 72.95 |
| ND 1.0 (10% transmission)    | KOND1.033 | 46.95 | KOND1.044 | 72.95 |
| ND 2.0 (1% transmission)     | KOND2.033 | 46.95 | KOND2.044 | 72.95 |
| ND 3.0 (0.10% transmission)  | KOND3.033 | 46.95 | KOND3.044 | 72.95 |
| ND 4.0 (0.010% transmission) | KOND4.033 | 46.95 | KOND4.044 | 72.95 |

Color conversion filters enable significant adjustments in the color temperature of the illumination required. Light balancing filters enable minor adjustments in the color quality of illumination to obtain warmer (yellowish) or cooler (bluish) color rendering. The degree of effect increases as you go down the alphabet.

| COLOR CONVERSION & LIGHT BALANCING FILTERS |          |       |          |       |
|--|----------|-------|----------|-------|
| Filter Description                         | 3x3      |       | 4x4      |       |
|  | Item #   | Price | Item #   | Price |
| 80A: Blue Conversion                       | KO80A33  | 23.95 | KO80A44  | 34.95 |
| 80B: Blue Conversion                       | KO80B33  | 23.95 | KO80B44  | 34.95 |
| 80C: Blue Conversion                       | KO80C33  | 23.95 | KO80C44  | 34.95 |
| 80D: Blue Conversion                       | KO80D33  | 23.95 | KO80D44  | 34.95 |
| 85: Amber Conversion                       | KO8533   | 23.95 | KO8544   | 34.95 |
| 85B: Amber Conversion                      | KO85B33  | 23.95 | KO85B44  | 34.95 |
| 85C: Amber Conversion                      | KO85C33  | 23.95 | KO85C44  | 34.95 |
| 85N3: Amber with ND0.3                     | KO85N333 | 23.95 | KO85N344 | 34.95 |
| 85N6: Amber with ND0.6                     | KO85N633 | 23.95 | KO85N644 | 34.95 |
| 85N9: Amber with ND0.9                     | KO85N933 | 23.95 | KO85N944 | 34.95 |
| 81: Yellowish light balancing              | KO8133   | 23.95 | KO8144   | 34.95 |
| 81A: Yellowish light balancing             | KO81A33  | 23.95 | KO81A44  | 34.95 |
| 81B: Yellowish light balancing             | KO81B33  | 23.95 | KO81B44  | 34.95 |
| 81C: Yellowish light balancing             | KO81C33  | 23.95 | KO81C44  | 34.95 |
| 81D: Yellowish light balancing             | KO81D33  | 23.95 | KO81D44  | 34.95 |
| 81EF: Yellowish light balancing            | KO81EF33 | 23.95 | KO81EF44 | 34.95 |
| 82: Bluish light balancing                 | KO8233   | 23.95 | KO8244   | 34.95 |
| 82A: Bluish light balancing                | KO82A33  | 23.95 | KO82A44  | 34.95 |
| 82B: Bluish light balancing                | KO82B33  | 23.95 | KO82B44  | 34.95 |
| 82C: Bluish light balancing                | KO82C33  | 23.95 | KO82C44  | 34.95 |

Color compensating filters control color by attenuating principally the red, green or blue part of the spectrum. Can be used to make changes in the color balance of images recorded on color films, or compensate for deficiencies in the spectral quality of a light source.

| COLOR COMPENSATION FILTERS |            |       |            |       |
|----------------------------|------------|-------|------------|-------|
| Filter Description         | 3x3        |       | 4x4        |       |
|                            | Item #     | Price | Item #     | Price |
| CC025B Blue                | KOCC025B33 | 23.95 | KOCC025B44 | 34.95 |
| CC05B Blue                 | KOCC05B33  | 23.95 | KOCC05B44  | 34.95 |
| CC10B Blue                 | KOCC10B33  | 23.95 | KOCC10B44  | 34.95 |
| CC20B Blue                 | KOCC20B33  | 23.95 | KOCC20B44  | 34.95 |
| CC30B Blue                 | KOCC30B33  | 23.95 | KOCC30B44  | 34.95 |
| CC40B Blue                 | KOCC40B33  | 23.95 | KOCC40B44  | 34.95 |
| CC50B Blue                 | KOCC50B33  | 23.95 | KOCC50B44  | 34.95 |
| CC025C Cyan                | KOCC025C33 | 23.95 | KOCC025C44 | 34.95 |
| CC05C Cyan                 | KOCC05C33  | 23.95 | KOCC05C44  | 34.95 |
| CC10C Cyan                 | KOCC10C33  | 23.95 | KOCC10C44  | 34.95 |
| CC20C Cyan                 | KOCC20C33  | 23.95 | KOCC20C44  | 34.95 |
| CC30C Cyan                 | KOCC30C33  | 23.95 | KOCC30C44  | 34.95 |
| CC40C Cyan                 | KOCC40C33  | 23.95 | KOCC40C44  | 34.95 |
| CC50C Cyan                 | KOCC50C33  | 23.95 | KOCC50C44  | 34.95 |
| CC025G Green               | KOCC025G33 | 23.95 | KOCC025G44 | 34.95 |
| CC05G Green                | KOCC05G33  | 23.95 | KOCC05G44  | 34.95 |
| CC10G Green                | KOCC10G33  | 23.95 | KOCC10G44  | 34.95 |
| CC20G Green                | KOCC20G33  | 23.95 | KOCC20G44  | 34.95 |
| CC30G Green                | KOCC30G33  | 23.95 | KOCC30G44  | 34.95 |
| CC40G Green                | KOCC40G33  | 23.95 | KOCC40G44  | 34.95 |
| CC50G Green                | KOCC50G33  | 23.95 | KOCC50G44  | 34.95 |
| CC025M Magenta             | KOCC025M33 | 23.95 | KOCC025M44 | 34.95 |
| CC05M Magenta              | KOCC05M33  | 23.95 | KOCC05M44  | 34.95 |
| CC10M Magenta              | KOCC10M33  | 23.95 | KOCC10M44  | 34.95 |
| CC20M Magenta              | KOCC20M33  | 23.95 | KOCC20M44  | 34.95 |
| CC30M Magenta              | KOCC30M33  | 23.95 | KOCC30M44  | 34.95 |
| CC40M Magenta              | KOCC40M33  | 23.95 | KOCC40M44  | 34.95 |
| CC50M Magenta              | KOCC50M33  | 23.95 | KOCC50M44  | 34.95 |
| CC025R Red                 | KOCC025R33 | 23.95 | KOCC025R44 | 34.95 |
| CC05R Red                  | KOCC05R33  | 23.95 | KOCC05R44  | 34.95 |
| CC10R Red                  | KOCC10R33  | 23.95 | KOCC10R44  | 34.95 |
| CC20R Red                  | KOCC20R33  | 23.95 | KOCC20R44  | 34.95 |
| CC30R Red                  | KOCC30R33  | 23.95 | KOCC30R44  | 34.95 |
| CC40R Red                  | KOCC40R33  | 23.95 | KOCC40R44  | 34.95 |
| CC50R Red                  | KOCC50R33  | 23.95 | KOCC50R44  | 34.95 |
| CC025Y Yellow              | KOCC025Y33 | 23.95 | KOCC025Y44 | 34.95 |
| CC05Y Yellow               | KOCC05Y33  | 23.95 | KOCC05Y44  | 34.95 |
| CC10Y Yellow               | KOCC10Y33  | 23.95 | KOCC10Y44  | 34.95 |
| CC20Y Yellow               | KOCC20Y33  | 23.95 | KOCC20Y44  | 34.95 |
| CC30Y Yellow               | KOCC30Y33  | 23.95 | KOCC30Y44  | 34.95 |
| CC40Y Yellow               | KOCC40Y33  | 23.95 | KOCC40Y44  | 34.95 |
| CC50Y Yellow               | KOCC50Y33  | 23.95 | KOCC50Y44  | 34.95 |

# LEE FILTERS

## FILTER HOLDER SYSTEM

FILTERS

390



The Lee Filter Holder system is so versatile that it can be fitted to almost any lens on any camera. This means that whether you're using a 35mm, medium, large format or even extreme wide-angle lens, you'll always enjoy the performance and benefits the system provides. The Lee Filter system represents the total approach to filtration in still photography. It is a package designed to enable you to choose exactly the components you need while still providing the ultimate in flexibility and performance.

An Adapter ring that screws onto the front of the lens is the key to the versatility of this system. Once the appropriate sized Adapter is fitted, the rest of the system clips neatly and easily into place. A filter holder with removable guides enable you to decide which combination of filters—from gels up to 4mm in thickness—would be most suitable for your needs. In addition, the holder rotates so you can make the most of filter effects, which is enhanced when two or more holders are fitted together to accept additional filters. For added convenience, the holder easily clips on and off the camera. Last, the system also features a unique lightweight lens hood which operates without requiring rails or guides.

### FEATURES

#### Adapter Rings

Adapter rings fit into the lens to accommodate the filter holder. Once the Adapter is in place the filter holder clips firmly to it using a smooth, quick-release, spring loaded mechanism.

Sturdily constructed with an aluminum screw thread, the adapters are available in both standard and wide-angle configurations.

The wide-angle adapters are designed so that the filter is placed as close as possible to the front element of the camera lens, and should be used when vignetting is encountered with a standard Adapter ring.



Standard rings have thread mounts that protrude from a plastic ring. Wide-angle rings have recessed threads in an all-metal ring.

Lens adapters are available from 49mm to 105mm, as well as 50mm, 60mm and 70mm Hasselblad bayonet mount.

|   |        |
|---|--------|
| 49 - 77mm #LEAR( ) .....                                      | 26.95  |
| 82 - 86mm #LEAR( ) .....                                      | 53.95  |
| 93mm, 95mm #LEAR( ) .....                                     | 98.95  |
| 100mm, 105mm, 112mm #LEAR( ) .....                            | 119.95 |
| 49 - 77mm Wide Angle #LEARWA( ) .....                         | 49.50  |
| 82mm Wide Angle (LEARWA82) .....                              | 58.50  |
| 50, 60, 70mm Hasselblad Bayonet Adapter Rings #LEARB( ) ..... | 62.95  |

#### Filter Holders

The Foundation Kit is the basic element of the Lee filter holder system. This kit contains all the necessary components (including a small screwdriver) to construct a versatile holder which will take up to four filters. When assembled, the holder in its standard form accepts three 100mm (4x4") x 2mm thick filters and one additional 4x4" gelatin filter.



Lee makes a variety of standard and wide angle adapter rings in screw-in and bayonet sizes as well as accessory compendium shades. When mounted, this holder will rotate on the adapter ring for positioning a polarizer or a graduated filter. Optional "side-guides" and guide mounting screws in shorter/longer lengths are available for use with 1mm and 4mm thick filters.

To use this holder, an optional adapter ring must be purchased. This holder comes with a storage pouch.

#### Gel Snap (4x4" Filter Holder) for Lenses up to 82mm



The Gel Snap is Lee's easy and affordable filter holder. Simply insert your 4 x 4" filter, snap it shut, and "snap" it on to any lens 82mm or smaller using the included "Elastomeric Tension Device", also known as an "E.T.D.", i.e. rubber band.

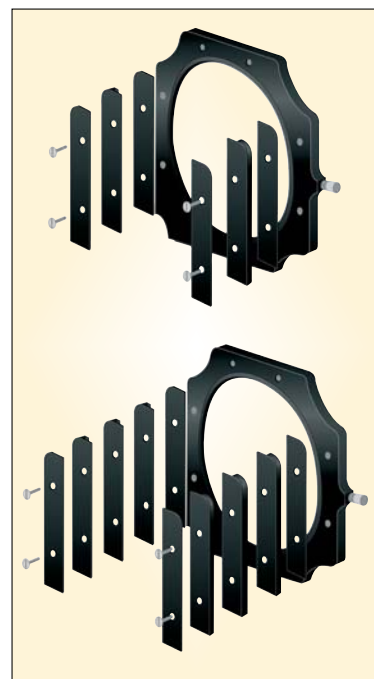

**EQUIPMENT LEASING AVAILABLE**



# LEE FILTERS

## FILTER HOLDER SYSTEM

### Lens Hoods

Lee filters were the originators of the self-supporting lens shade, a technology which is now used throughout their range of hoods. The bellows are manually adjusted to the required position without using rails or guides reducing size and weight. They are completely flexible and can be used off-angle to selectively shield or match movements on a large format camera.

Lee lens hoods are available in many configurations to suit all types of camera equipment and all types of photography. They can be attached to the Lee holder or direct to the Adapter ring.



### Single and Double-Slotted Filter Hood

The slotted filter hood has all the features of the standard hood except that it only fits directly to the lens via an Adapter ring. Features either one or two 2mm (double-slotted filter hood) filter slots immediately behind the bellows with vignette guides already fitted. Ideal for social or studio photographers who may not need a full filter holder.



**Hood w/1-Filter Slot (LELHFS).....117.95**

**Hood w/2-Filter Slot (LELHFS2) .....124.95**

### Standard Hood

The standard hood fits any Lee Filter holder provided a 2mm slot is fitted to the front of the holder, or it can be fitted directly to the lens Adapter ring. The self-supporting bellows adjust to the required position without using guides or rails. Additionally, a set of guides to enable vignettes to be fitted is available and can be placed in front of the hood for added versatility.



**Standard Lens Hood (LELH).....109.95**

### Wide-Angle Lens Hoods

Wide-angle lens hoods have much larger bellows to allow for effective shading on wide or particularly large lenses, where the use of standard hoods could cause vignetting. Available as a wide equivalent of either the standard or the slotted hood.



**Wide Angle Lens Hood (LELHWA) .....229.95**

**Wide Angle Hood w/1-filter slot (LELHWAFS) .....224.95**

**Wide Angle Hood w/2-filter slot (LELHWAFS2).....224.95**

### Resin Filters

The Lee Filters resin filter range includes color effect, graduated, striped and special effect filters, available in either economically packaged boxed sets or as single items. Standard sizes to fit the Lee Filters system are 100 x 150mm or 100 x 100mm.

The Lee Filters resins are made from lightweight, optically correct polymeric materials, which are tough, easy to handle and can be wiped clean. Every filter is individually hand made by skilled technicians and is then passed through a rigorous quality control system to ensure 100% accuracy and consistency.

Graduated filters feature an area of color at one end of the resin, with the opposite end remaining clear. This enables the color or effect to be placed in a specific area of the frame by the positioning of the filter either up or down in the holder. The transition from color to clear can be fast (hard grad), slow (soft grad) or blended (transition is across the entire length of the filter.) Stripe filters are used to place a band of color or effect across a specific area of the frame. The special effects range features a wide selection of fogs, nets, starbursts, low contrast and soft focus filters.



### Polyester Filters

The Lee Filters' technical filters have been designed to overcome the problems that are created by the interaction of different light sources with modern film. The filters are manufactured from the highest quality polyester-based material, as polyester is tough, impervious to water and easy to clean.

These filters can be mounted in frames or cut to fit the photographers existing filter system. All the filter sets are supplied ready mounted for use with the Lee holder system.

In addition to standard correction filters, the range of technical filters include fluorescent, correction and neutral densities, together with color compensating and colorprinting grades.



### Glass Filters

Lee Filters also offers a range of photographic filters in glass, including star filters, polarizing filters and an enhancing filter to accentuate reds and oranges without affecting other colors.

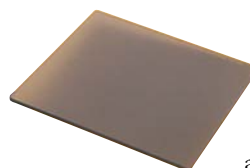

# LEE FILTERS

## FILTERS

### Black & White Filters



Without filter



Without filter



with Yellow 8 filter



with Yellow/Green 11 filter



with Orange 21 filter



with Light Red 23A filter

**Light Yellow #3:** Commonly used to raise contrast slightly. Especially useful for clear contrast between blue sky with clouds and foreground. Suitable for portraits, landscapes and nature scenes.

**Yellow #8:** For increased contrast between cloud and sky greater than #3.

**Yellow-Green #11:** Ideal for scenes where it is important to differentiate the green tonal values. Well-suited to landscape photography because it enhances the light green color of the leaves. Due to its favorable effect on red tones, it is also suitable for portraits.

**Deep-Yellow #12:** Minus blue filter. Can be used to cancel blue light when infrared-sensitive films are exposed. Also used to penetrate haze during aerial photography.

**Deep-Yellow #15:** For increased contrast between cloud and sky greater than Yellow #8. Also used for copying documents on yellowed paper.

**Yellow-Orange #16:** Gives even greater over-correction than Deep Yellow #15. Absorbs a small amount of green.

**Orange #21:** Darkens blue, violet, green and yellow-green. It is particularly useful for all landscape and architectural photography requiring vivid contours. The sky is distinctly toned with the clouds clearly contrasted against it.

**Light Red #23A:** Greater contrast effect than Orange #21

*Please note: All descriptions refer to the filter's effect when used with black & white film unless noted otherwise.*

|                   | 3x3" Polyester  | 4x4" Polyester   | 4x4" Resin      |
|-------------------|-----------------|------------------|-----------------|
| Light Yellow #3   | —               | 15.95 (LE344Q)   | 69.95 (LE344)   |
| Yellow #8         | 10.95 (LE833)   | 15.95 (LE844Q)   | 69.95 (LE844)   |
| Yellow Green #11  | 10.95 (LE1133)  | 15.95 (LE1144Q)  | 69.95 (LE1144)  |
| Deep Yellow #12   | 10.95 (LE1233)  | 15.95 (LE1244Q)  | 69.95 (LE1244)  |
| Deep Yellow #15   | 10.95 (LE1533)  | 15.95 (LE1544Q)  | 69.95 (LE1544)  |
| Yellow Orange #16 | 10.95 (LE1633)  | 15.95 (LE1644Q)  | 69.95 (LE1644)  |
| Orange #21        | 10.95 (LE2133)  | 15.95 (LE2144Q)  | 69.95 (LE2144)  |
| Light Red #23A    | 10.95 (LE23A33) | 15.95 (LE23A44Q) | 69.95 (LE23A44) |

**Clear Filter:** A clear (colorless) filter for color as well as black and white films. It also serves as a permanent lens protector.

3x3" Polyester Clear Filter (LEC33) .....10.95

4x4" Polyester Clear Filter (LEC44Q).....15.95

**UV Filter:** Haze (UV) filters provide correction for ultraviolet light which can register on film as a bluish cast and obscure distant details. Ultraviolet filters allow you to correct for the UV effect to varying degrees.

4x4" Resin UV Filter (LEUV44) .....54.95

**UV-1A:** Also known as a skylight filter, 1A filters are pale pink. They absorb ultraviolet radiation and reduce the excess bluishness of outdoor color scenes photographed in open shade under a clear, blue sky.

3x3" Polyester UV-1A Filter (LEUV1A33) ...10.95

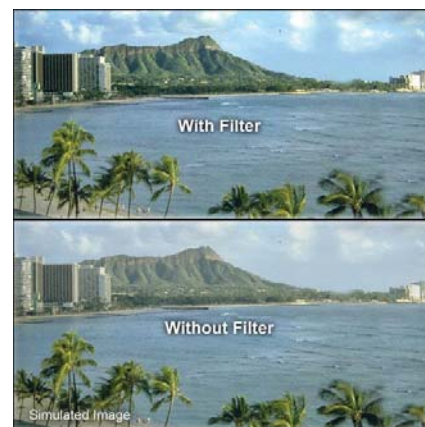

#### UV-1B:

Similar to the UV-1A, but a little stronger.

3x3" Polyester UV-1B Filter (LEUV1B33) ....10.95

4x4" Polyester UV-1B Filter (LEUV1B44) .....15.95

#### UV-2B

Useful for high altitude photography, the UV-2B eliminates almost all UV present.

3x3" Polyester UV-2B Filter (LEUV2B33) .....10.95

4x4" Resin UV-2B Filter (LEUV2B44) .....54.95

#### UV-2C

Similar to the UV-2B, but a little stronger.

3x3" Polyester UV-2C Filter (LEUV2C33) ...10.95



### Polarizers

Polarizers are high quality glass filters that manage the waveforms of light travelling to the camera from most reflective surfaces. Glare and reflected light can be altered by rotation of the polarizing filter. The effect can be seen through the lens of reflex cameras as the filter is rotated. When used outside on sunny days, polarizing filters have the effect of saturating colors and deepening blue skies. They can also be used in conjunction with other filters (although the polarizer should always be placed in front of polyester filters to ensure it functions correctly).



without filter



with Polarizer filter

Both linear and circular polarizers are available in a rotating 105mm diameter version and a 100x100mm (4x4") square version. 100mm square polarizers are to be used in the filter holder, the entire holder is then rotated to achieve the correct effect. Recommended for



studio use or for when only the polarizer and, possibly, standard filters are to be used.

105mm rotating polarizers are attached to the filter system via a special ring that is

fitted to the front of the holder. This allows the polarizer to be rotated independently of any grads used and is ideal for landscape photography where extra flexibility is required.

**4x4" Linear Polarizer Glass Filter (LEP44).....168.95**

**4x4" Circular Polarizer Glass Filter (LECP44).....223.95**

**105mm Circular Polarizer Glass Filter (LECP105).....266.50**

### Enhancing Filter



without filter



with Enhancing filter

Lee's Enhancing filter is a combination of rare earth elements in glass. It removes a portion of the spectrum in the orange region, increasing the color saturation of reddish objects by eliminating the muddy tones and maximizing the red hues with minimal effect on other colors. Its most frequent use is for obtaining strongly saturated photographs of fall foliage. Viewing the subject through the filter first, without mounting on the lens, helps to identify which parts of the picture will be affected..... (LEE44) **264.95**

### Neutral Density (ND) Filters

Neutral density (ND) filters reduce light transmission uniformly over the visible region of the spectrum, in definitive steps. Mainly used in color photography for reducing light levels without color change, they can also be used for B&W photography. They are particularly useful for compensating for too much light, in circumstances where changing the shutter speed, aperture or film type is not possible or desirable. For example, exposure time can be increased to achieve special effects when photographing running water and waterfalls etc., without adjusting the aperture. In addition, depth of field can be reduced by increasing the aperture by the stop value of the filter used. For example, if the aperture is required to be f4 yet correct exposure is at f8 and the speed cannot be changed, a 0.6ND filter will allow the setting of the f4 aperture.



without filter



with 0.6 ND filter

| Neutral Density | Stop Value | Transmission % | 3x3" Polyester   | 4x4" Polyester    | 4x4" Resin       |
|-----------------|------------|----------------|------------------|-------------------|------------------|
| 0.1             | 1/3        | 79.4           | 14.95 (LEND.133) | 31.95 (LEND.144)  | —                |
| 0.2             | 2/3        | 63.1           | 14.95 (LEND.233) | 31.95 (LEND.244)  | —                |
| 0.3             | 1          | 50.0           | 14.95 (LEND.333) | 31.95 (LEND.344Q) | 74.95 (LEND.344) |
| 0.4             | 1½         | 39.8           | 14.95 (LEND.433) | 31.95 (LEND.444)  | —                |
| 0.5             | 1½         | 31.6           | 14.95 (LEND.533) | 31.95 (LEND.544)  | —                |
| 0.6             | 2          | 25.0           | 14.95 (LEND.633) | 31.95 (LEND.644Q) | 74.95 (LEND.644) |
| 0.7             | 2½         | 19.6           | 14.95 (LEND.733) | 31.95 (LEND.744)  | —                |
| 0.8             | 2½         | 15.9           | 14.95 (LEND.833) | 31.95 (LEND.844)  | —                |
| 0.9             | 3          | 12.5           | 14.95 (LEND.933) | 31.95 (LEND.944Q) | 74.95 (LEND.944) |

# LEE FILTERS

## COLOR COMPENSATING FILTERS

FILTERS

394

A range of filters recommended for use either in front of or behind the lens. They control the spectrum by reducing the transmission at specific wavelengths. They are primarily used to color balance films, the required filter being determined as a result of tests, or as specified by the manufacturer. They can also be useful for correcting light sources for which no single conversion filter exists, or for adding a deliberate color bias.

Some photographic situations require specific color corrections. For example, when shooting daylight film under fluorescent lighting, some magenta correction is needed to remove the greenish tint that appears. The amount of color correction required is most accurately measured via a color temperature meter.

|                | 025 | 05  | 10  | 15  | 20  | 25  | 30  | 40  | 50  |                                  |
|----------------|-----|-----|-----|-----|-----|-----|-----|-----|-----|----------------------------------|
| <b>Cyan</b>    | Nil | 1/3 | 1/3 | 1/3 | 1/3 | 1/3 | 2/3 | 2/3 | 2/3 | Principally absorbs Red          |
| <b>Yellow</b>  | Nil | Nil | 1/3 | 1/3 | 1/3 | 1/3 | 1/3 | 1/3 | 1/3 | Principally absorbs Blue         |
| <b>Magenta</b> | Nil | 1/3 | 1/3 | 1/3 | 2/3 | 2/3 | 2/3 | 1   | 1   | Principally absorbs Green        |
| <b>Red</b>     | Nil | 1/3 | 1/3 | 1/3 | 2/3 | 2/3 | 2/3 | 1   | 1   | Principally absorbs Blue & Green |
| <b>Green</b>   | Nil | 1/3 | 1/3 | 1/3 | 1/3 | 1/3 | 1/3 | 2/3 | 2/3 | Principally absorbs Blue & Red   |
| <b>Blue</b>    | Nil | 1/3 | 1/3 | 1/3 | 2/3 | 1   | 1½  | 1½  | 1½  | Principally absorbs Red & Green  |

*The values shown are approximate exposure increases to compensate for the filters used.*

Color compensating filters are available in the three primary colors: Red, Green, and Blue; and in the three secondary colors: Cyan, Magenta, and Yellow.

A typical designation for one of these filters is CC30M. The "CC" stands for color compensating. The "30" stands for a density of 0.30 and the "M" is for magenta. Lee color compensating filters are made in the following increasing densities: 0.025 (CC025), 0.05 (CC05), 0.10 (CC10), 0.15 (CC15), 0.20 (CC20), 0.25 (CC25), 0.30 (CC30), 0.40 (CC40), 0.50 (CC50).

|   | 3x3" Polyester     | 4x4" Polyester      | 4x4" Resin         |
|---|--------------------|---------------------|--------------------|
| <b>Cyan Color Compensating Filters</b>    |                    |                     |                    |
| <b>CC025C</b>                             | 10.95 (LECC025C33) | 15.95 (LECC025C44Q) | 54.95 (LECC025C44) |
| <b>CC05C</b>                              | 10.95 (LECC05C33)  | 15.95 (LECC05C44Q)  | 54.95 (LECC05C44)  |
| <b>CC10C</b>                              | 10.95 (LECC10C33)  | 15.95 (LECC10C44Q)  | 54.95 (LECC10C44)  |
| <b>CC15C</b>                              | 10.95 (LECC15C33)  | 15.95 (LECC15C44Q)  | 54.95 (LECC15C44)  |
| <b>CC20C</b>                              | 10.95 (LECC20C33)  | 15.95 (LECC20C44Q)  | 54.95 (LECC20C44)  |
| <b>CC25C</b>                              | 10.95 (LECC25C33)  | 15.95 (LECC25C44Q)  | 54.95 (LECC25C44)  |
| <b>CC30C</b>                              | 10.95 (LECC30C33)  | 15.95 (LECC30C44Q)  | 54.95 (LECC30C44)  |
| <b>CC40C</b>                              | 10.95 (LECC40C33)  | 15.95 (LECC40C44Q)  | 54.95 (LECC40C44)  |
| <b>CC50C</b>                              | 10.95 (LECC50C33)  | 15.95 (LECC50C44Q)  | 54.95 (LECC50C44)  |
| <b>Magenta Color Compensating Filters</b> |                    |                     |                    |
| <b>CC025M</b>                             | 10.95 (LECC025M33) | 15.95 (LECC025M44Q) | 54.95 (LECC025M44) |
| <b>CC05M</b>                              | 10.95 (LECC05M33)  | 15.95 (LECC05M44Q)  | 54.95 (LECC05M44)  |
| <b>CC10M</b>                              | 10.95 (LECC10M33)  | 15.95 (LECC10M44Q)  | 54.95 (LECC10M44)  |
| <b>CC15M</b>                              | 10.95 (LECC15M33)  | 15.95 (LECC15M44Q)  | 54.95 (LECC15M44)  |
| <b>CC20M</b>                              | 10.95 (LECC20M33)  | 15.95 (LECC20M44Q)  | 54.95 (LECC20M44)  |
| <b>CC25M</b>                              | 10.95 (LECC25M33)  | 15.95 (LECC25M44Q)  | 54.95 (LECC25M44)  |
| <b>CC30M</b>                              | 10.95 (LECC30M33)  | 15.95 (LECC30M44Q)  | 54.95 (LECC30M44)  |
| <b>CC40M</b>                              | 10.95 (LECC40M33)  | 15.95 (LECC40M44Q)  | 54.95 (LECC40M44)  |
| <b>CC50M</b>                              | 10.95 (LECC50M33)  | 15.95 (LECC50M44Q)  | 54.95 (LECC50M44)  |
| <b>Green Color Compensating Filters</b>   |                    |                     |                    |
| <b>CC025G</b>                             | 10.95 (LECC025G33) | 15.95 (LECC025G44Q) | 54.95 (LECC025G44) |
| <b>CC05G</b>                              | 10.95 (LECC05G33)  | 15.95 (LECC05G44Q)  | 54.95 (LECC05G44)  |
| <b>CC10G</b>                              | 10.95 (LECC10G33)  | 15.95 (LECC10G44Q)  | 54.95 (LECC10G44)  |
| <b>CC15G</b>                              | 10.95 (LECC15G33)  | 15.95 (LECC15G44Q)  | 54.95 (LECC15G44)  |
| <b>CC20G</b>                              | 10.95 (LECC20G33)  | 15.95 (LECC20G44Q)  | 54.95 (LECC20G44)  |
| <b>CC25G</b>                              | 10.95 (LECC25G33)  | 15.95 (LECC25G44Q)  | 54.95 (LECC25G44)  |
| <b>CC30G</b>                              | 10.95 (LECC30G33)  | 15.95 (LECC30G44Q)  | 54.95 (LECC30G44)  |
| <b>CC40G</b>                              | 10.95 (LECC40G33)  | 15.95 (LECC40G44Q)  | 54.95 (LECC40G44)  |
| <b>CC50G</b>                              | 10.95 (LECC50G33)  | 15.95 (LECC50G44Q)  | 54.95 (LECC50G44)  |

|  | 3x3" Polyester     | 4x4" Polyester      | 4x4" Resin         |
|--|--------------------|---------------------|--------------------|
| <b>Yellow Color Compensating Filters</b> |                    |                     |                    |
| <b>CC025Y</b>                            | 10.95 (LECC025Y33) | 15.95 (LECC025Y44Q) | 54.95 (LECC025Y44) |
| <b>CC05Y</b>                             | 10.95 (LECC05Y33)  | 15.95 (LECC05Y44Q)  | 54.95 (LECC05Y44)  |
| <b>CC10Y</b>                             | 10.95 (LECC10Y33)  | 15.95 (LECC10Y44Q)  | 54.95 (LECC10Y44)  |
| <b>CC15Y</b>                             | 10.95 (LECC15Y33)  | 15.95 (LECC15Y44Q)  | 54.95 (LECC15Y44)  |
| <b>CC20Y</b>                             | 10.95 (LECC20Y33)  | 15.95 (LECC20Y44Q)  | 54.95 (LECC20Y44)  |
| <b>CC25Y</b>                             | 10.95 (LECC25Y33)  | 15.95 (LECC25Y44Q)  | 54.95 (LECC25Y44)  |
| <b>CC30Y</b>                             | 10.95 (LECC30Y33)  | 15.95 (LECC30Y44Q)  | 54.95 (LECC30Y44)  |
| <b>CC40Y</b>                             | 10.95 (LECC40Y33)  | 15.95 (LECC40Y44Q)  | 54.95 (LECC40Y44)  |
| <b>CC50Y</b>                             | 10.95 (LECC50Y33)  | 15.95 (LECC50Y44Q)  | 54.95 (LECC50Y44)  |
| <b>Red Color Compensating Filters</b>    |                    |                     |                    |
| <b>CC025R</b>                            | 10.95 (LECC025R33) | 15.95 (LECC025R44Q) | 54.95 (LECC025R44) |
| <b>CC05R</b>                             | 10.95 (LECC05R33)  | 15.95 (LECC05R44Q)  | 54.95 (LECC05R44)  |
| <b>CC10R</b>                             | 10.95 (LECC10R33)  | 15.95 (LECC10R44Q)  | 54.95 (LECC10R44)  |
| <b>CC15R</b>                             | 10.95 (LECC15R33)  | 15.95 (LECC15R44Q)  | 54.95 (LECC15R44)  |
| <b>CC20R</b>                             | 10.95 (LECC20R33)  | 15.95 (LECC20R44Q)  | 54.95 (LECC20R44)  |
| <b>CC25R</b>                             | 10.95 (LECC25R33)  | 15.95 (LECC25R44Q)  | 54.95 (LECC25R44)  |
| <b>CC30R</b>                             | 10.95 (LECC30R33)  | 15.95 (LECC30R44Q)  | 54.95 (LECC30R44)  |
| <b>CC40R</b>                             | 10.95 (LECC40R33)  | 15.95 (LECC40R44Q)  | 54.95 (LECC40R44)  |
| <b>CC50R</b>                             | 10.95 (LECC50R33)  | 15.95 (LECC50R44Q)  | 54.95 (LECC50R44)  |
| <b>Blue Color Compensating Filters</b>   |                    |                     |                    |
| <b>CC025B</b>                            | 10.95 (LECC025B33) | 15.95 (LECC025B44Q) | 54.95 (LECC025B44) |
| <b>CC05B</b>                             | 10.95 (LECC05B33)  | 15.95 (LECC05B44Q)  | 54.95 (LECC05B44)  |
| <b>CC10B</b>                             | 10.95 (LECC10B33)  | 15.95 (LECC10B44Q)  | 54.95 (LECC10B44)  |
| <b>CC15B</b>                             | 10.95 (LECC15B33)  | 15.95 (LECC15B44Q)  | 54.95 (LECC15B44)  |
| <b>CC20B</b>                             | 10.95 (LECC20B33)  | 15.95 (LECC20B44Q)  | 54.95 (LECC20B44)  |
| <b>CC25B</b>                             | 10.95 (LECC25B33)  | 15.95 (LECC25B44Q)  | 54.95 (LECC25B44)  |
| <b>CC30B</b>                             | 10.95 (LECC30B33)  | 15.95 (LECC30B44Q)  | 54.95 (LECC30B44)  |
| <b>CC40B</b>                             | 10.95 (LECC40B33)  | 15.95 (LECC40B44Q)  | 54.95 (LECC40B44)  |
| <b>CC50B</b>                             | 10.95 (LECC50B33)  | 15.95 (LECC50B44Q)  | 54.95 (LECC50B44)  |





## COLOR TEMPERATURE FILTERS

Lee's color temperature filters are used to convert the color temperature of a light source to balance with the film type in use, or to create an intentional "warm" or "cool" effect.

### 80 Series (Blue for Major Adjustment):

The 80 series of filters are blue. They are used to balance daylight film under artificial, tungsten or standard (household) incandescent lighting.

### 81 Series (Pale Amber for Fine Adjustment):

The 81 Series controls the bluish coloration that can affect daylight film. They warm scenes shot on cloudy days, and can remove excessive blue from the effects of electronic flash. The 81 series is available in grades from 81 through 81EF, with 81EF having the warmest effect.

### 82 Series (Pale Blue for Fine Adjustment):

The 82 series are light balancing filters used to increase the color temperature slightly for a cooler tone. This light blue filter absorbs the excessive yellow-red light from daylight in the morning and evening hours and keeps skin tones close to natural. Filters are available in grades from 82 through 82C, with 82C having the greatest cooling effect.

### 85 Series (Amber for Major Adjustment):

Using tungsten film in daylight will produce a bluish cast in the photograph. The 85 series will produce natural colors when shooting with tungsten film outdoors. A #85 filter will decrease the color temperature from 5500K to 3400K and produce slightly cooler results than an 85B.

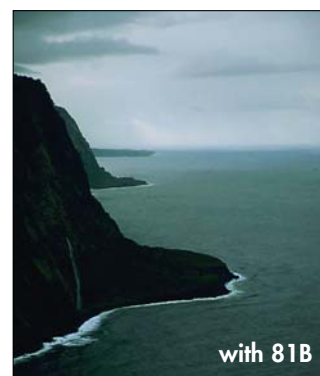
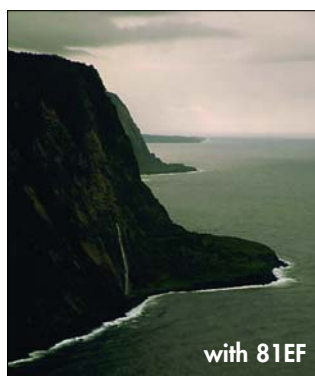
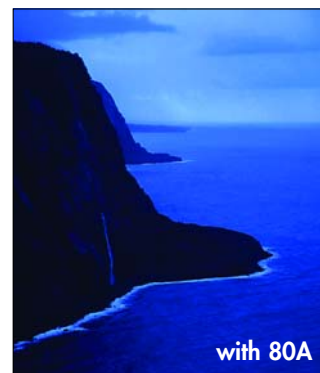
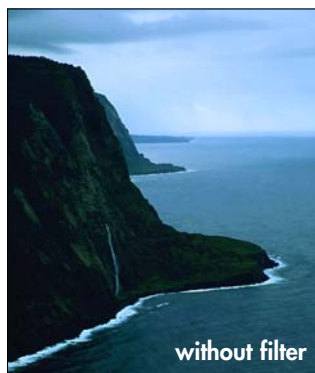

| Filter | Exposure Increase | Conversion     | Mired Shift | 3x3" Polyester |       | 4x4" Polyester |       | 4x4" Resin |       |
|--------|-------------------|----------------|-------------|----------------|-------|----------------|-------|------------|-------|
|        |                   |                |             | Order No.      | Price | Order No.      | Price | Order No.  | Price |
| 80A    | 2                 | 3200K to 5500K | -131        | #LE80A33       | 10.95 | #LE80A44Q      | 15.95 | #LE80A44   | 49.95 |
| 80B    | 1½                | 3400K to 5500K | -112        | #LE80B33       | 10.95 | #LE80B44Q      | 15.95 | #LE80B44   | 49.95 |
| 80C    | 1                 | 3800K to 5500K | -81         | #LE80C33       | 10.95 | #LE80C44Q      | 15.95 | #LE80C44   | 49.95 |
| 80D    | 2/3               | 4200K to 5500K | -56         | #LE80D33       | 10.95 | #LE80D44Q      | 15.95 | #LE80D44   | 49.95 |
| 81     | 1/3               | 3300K to 3200K | +9          | #LE8133        | 10.95 | #LE8144Q       | 15.95 | #LE8144    | 49.95 |
| 81A    | 1/3               | 3400K to 3200K | +18         | #LE81A33       | 10.95 | #LE81A44Q      | 15.95 | #LE81A44   | 49.95 |
| 81B    | 1/3               | 3500K to 3200K | +27         | #LE81B33       | 10.95 | #LE81B44Q      | 15.95 | #LE81B44   | 49.95 |
| 81C    | 1/3               | 3600K to 3200K | +35         | #LE81C33       | 10.95 | #LE81C44Q      | 15.95 | #LE81C44   | 49.95 |
| 81D    | 2/3               | 3700K to 3200K | +42         | #LE81D33       | 10.95 | #LE81D44Q      | 15.95 | #LE81D44   | 49.95 |
| 81EF   | 2/3               | 3850K to 3200K | +53         | #LE81EF33      | 10.95 | #LE81EF44Q     | 15.95 | #LE81EF44  | 49.95 |
| 82     | 1/3               | 3100K to 3200K | -10         | #LE8233        | 10.95 | #LE8244Q       | 15.95 | #LE8244    | 49.95 |
| 82A    | 1/3               | 3000K to 3200K | -21         | #LE82A33       | 10.95 | #LE82A44Q      | 15.95 | #LE82A44   | 49.95 |
| 82B    | 2/3               | 2900K to 3200K | -32         | #LE82B33       | 10.95 | #LE82B44Q      | 15.95 | #LE82B44   | 49.95 |
| 82C    | 2/3               | 2800K to 3200K | -45         | #LE82C33       | 10.95 | #LE82C44Q      | 15.95 | #LE82C44   | 49.95 |
| 85     | 2/3               | 5500K to 3400K | +112        | #LE8533        | 10.95 | #LE8544Q       | 15.95 | #LE8544    | 49.95 |
| 85B    | 2/3               | 5500K to 3200K | +131        | #LE85B33       | 10.95 | #LE85B44Q      | 15.95 | #LE85B44   | 49.95 |
| 85C    | 2/3               | 5500K to 3800K | +81         | #LE85C33       | 10.95 | #LE85C44Q      | 15.95 | #LE85C44   | 49.95 |

# LEE FILTERS

## FILTERS

FILTERS

396

### 81 + Red Combination Filters



without filter



with 81+Red filter

Add warmth to portraits. The 81 + Red series combines an 81 series color temperature filter with varying degrees of red CC filter. This unique combination of filtration enhances the magenta end of the spectrum, resulting in the ideal correction for landscapes and outdoor portraits.

The 81 + Red filters are 4 x 4" x 2mm thick optical resin filters, designed to fit in the Lee Filters system of filter holders and hoods.

|                 |                    |                |       |
|-----------------|--------------------|----------------|-------|
| 81 + CC05 Red   | 4x4" Resin Filters | (LE81CC05R44)  | 99.95 |
| 81A + CC075 Red | 4x4" Resin Filters | (LE81ACC075R4) | 99.95 |
| 81B + CC10 Red  | 4x4" Resin Filters | (LE81BCC10R44) | 99.95 |

### Standard Warming + Neutral Density (ND) Combination Filters

These unique filters were developed to provide selected color temperature adjustments combined with neutral density in one filter.

| CT/ND Combination      | Approximate Exposure Increase | Conversion     | Mired Shift |
|------------------------|-------------------------------|----------------|-------------|
| 85BN3, 85BN6, 85BN9    | 1-2/3, 2-2/3, 3-2/3,          | 5500K to 3200K | + 131       |
| 85N3, 85N6, 85N9       | 1-2/3, 2-2/3, 3-2/3,          | 5500K to 3400K | + 112       |
| 81EFN3, 81EFN6, 81EFN9 | 1-2/3, 2-2/3, 3-2/3,          | 3850K to 3200K | + 53        |

| Filter     | 3x3" Polyester          | 4x4" Polyester          | 4x4" Resin               |
|------------|-------------------------|-------------------------|--------------------------|
| 85 +ND.3   | 14.95<br>(LE85ND.333)   | 31.95<br>(LE85ND.344Q)  | 109.95<br>(LE85ND.344)   |
| 85 +ND.6   | 14.95<br>(LE85ND.633)   | 31.95<br>(LE85ND.644Q)  | 109.95<br>(LE85ND.644)   |
| 85 +ND.9   | 14.95<br>(LE85ND.933)   | 31.95<br>(LE85ND.944Q)  | 109.95<br>(LE85ND.944)   |
| 85B +ND.3  | 14.95<br>(LE85BND.333)  | 31.95<br>(LE85BND.344Q) | 109.95<br>(LE85BND.344)  |
| 85B +ND.6  | 14.95<br>(LE85BND.633)  | 31.95<br>(LE85BND.644Q) | 109.95<br>(LE85BND.644)  |
| 85B +ND.9  | 14.95<br>(LE85BND.933)  | 31.95<br>(LE85BND.944Q) | 109.95<br>(LE85BND.944)  |
| 81EF +ND.3 | 14.95<br>(LE81EFND.333) | 31.95<br>(LE81EFND.34Q) | 109.95<br>(LE81EFND.344) |
| 81EF +ND.6 | 14.95<br>(LE81EFND.633) | 31.95<br>(LE81EFND.64Q) | 109.95<br>(LE81EFND.644) |
| 81EF +ND.9 | 14.95<br>(LE81EFND.933) | 31.95<br>(LE81EFND.94Q) | 109.95<br>(LE81EFND.944) |

### Fog Filters

A natural fog causes lights to glow and flare. Contrast is lower, and sharpness may be affected as well. Fog filters mimic the effect of atomized water droplets in the air. These filters can take the edge off excess contrast and sharpness. Lee Fog filters are available in grades 1-5, with 5 having the strongest effect.



without filter



with Fog 4

|       |                   |           |       |
|-------|-------------------|-----------|-------|
| Fog 1 | 4x4" Resin Filter | (#LEF144) | 54.95 |
| Fog 2 | 4x4" Resin Filter | (#LEF244) | 54.95 |
| Fog 3 | 4x4" Resin Filter | (#LEF344) | 54.95 |
| Fog 4 | 4x4" Resin Filter | (#LEF444) | 54.95 |
| Fog 5 | 4x4" Resin Filter | (#LEF544) | 54.95 |

### Low Contrast Filters

These filters spread light from the highlights to the shadowed and darker areas, leaving the bright areas of the image bright. This enables you to see more detail in the shadow areas. As there is no f-stop compensation, you will not overexpose any portion of the image. This filter also creates a very slight flare or halation around hot spots and individual light sources, which is a useful effect. The more light there is for the filter to work with, the greater the effect. Available in grades from 1/4 through 1½, with the 1½ having the heaviest effect

|                  |                   |              |       |
|------------------|-------------------|--------------|-------|
| Low Contrast 1/4 | 4x4" Resin Filter | (#LELC.2544) | 54.95 |
| Low Contrast 1/2 | 4x4" Resin Filter | (#LELC.544)  | 54.95 |
| Low Contrast 3/4 | 4x4" Resin Filter | (#LELC.7544) | 54.95 |
| Low Contrast 1   | 4x4" Resin Filter | (#LELC144)   | 54.95 |
| Low Contrast 1½  | 4x4" Resin Filter | (#LELC1.544) | 54.95 |

### Star Effects Filters

Star Effect filters create multiple points of light, or "stars" streaking outward from a central light source. This can make lighting within the scene take on a more glittering, glamorous appearance. The size and brightness of the star lines produced are first a function of the size, shape, and brightness of the light source. Generally, mid-range apertures or larger are sufficient to achieve a good star effect.

|                         |                   |             |       |
|-------------------------|-------------------|-------------|-------|
| 4-Point/1mm Star Effect | 4x4" Resin Filter | (#LES4P144) | 49.95 |
| 6-Point/2mm Star Effect | 4x4" Resin Filter | (#LES6P244) | 49.95 |
| 8-Point/2mm Star Effect | 4x4" Resin Filter | (#LES8P244) | 49.95 |



For Any Inquiries Regarding Your Order, Call Our Customer Service:  
(800) 221-5743 • (212) 239-7765 • FAX: (800) 947-2215 • (212) 239-7549

## FILTERS

### Infrared (IR) Filter



without filter



with Infrared 87 filter

A visually opaque filter used in infrared photography to absorb unwanted visible light. This filter is for black and white infrared film when you only want to transmit the infrared spectrum and none of the visible spectrum. Transmission begins above 730 nanometers. Filter factor is determined by the film sensitivity.

|                            |                              |          |              |
|----------------------------|------------------------------|----------|--------------|
| <b>Infrared #87 Filter</b> | <b>3x3" Polyester Filter</b> | (LE8733) | <b>13.95</b> |
| <b>Infrared #87 Filter</b> | <b>4x4" Polyester Filter</b> | (LE8744) | <b>23.95</b> |

### Fluorescent Correction Filters (CC/CT)

This system offers filter solutions to many fluorescent correction problems. Both color temperature conversion and green absorption functions are combined into one filter: the filter will depend on the fluorescent light and film type.



without filter



with FL36D filter

| Filter                                     | 3x3" Polyester               | 4x4" Polyester                 | 4x4" Resin                    |
|--|------------------------------|--------------------------------|-------------------------------|
| <b>FL36D</b> Fluorescent 3600K to Daylight | <b>8.80</b><br>(LEFLD360033) | <b>13.60</b><br>(LEFLD360044Q) | <b>64.95</b><br>(LEFLD360044) |
| <b>FL43D</b> Fluorescent 4300K to Daylight | <b>8.80</b><br>(LEFLD430033) | <b>13.60</b><br>(LEFLD430044Q) | <b>64.95</b><br>(LEFLD430044) |
| <b>FL57D</b> Fluorescent 5700K to Daylight | <b>8.80</b><br>(LEFLD570033) | <b>13.60</b><br>(LEFLD570044Q) | <b>64.95</b><br>(LEFLD570044) |
| <b>FL36B</b> Fluorescent 3600K to Tungsten | <b>8.80</b><br>(LEFLB360033) | <b>13.60</b><br>(LEFLB360044Q) | <b>64.95</b><br>(LEFLB360044) |
| <b>FL43B</b> Fluorescent 4300K to Tungsten | <b>8.80</b><br>(LEFLB430033) | <b>13.60</b><br>(LEFLB430044Q) | <b>64.95</b><br>(LEFLB430044) |
| <b>FL57B</b> Fluorescent 5700K to Tungsten | <b>8.80</b><br>(LEFLB570033) | <b>13.60</b><br>(LEFLB570044Q) | <b>64.95</b><br>(LEFLB570044) |

### Net Diffusion Filters

Net filters consist of a net-like pattern on clear optical resin. This creates a diffusion effect, minimizing unwanted details while maintaining image clarity. Ideal for portraits with best results achieved when larger apertures are used. These filters are available in Black or White in Grades 1, 2 and 3, and Flesh.

Based on net filters commonly used in cinematography, these filters provide a subtle soft focus effect while also increasing (black net) or decreasing (white net) contrast. If required the selective hole can be slid into the frame to provide an unaffected clear center effect.

The black net 1 has an approximate exposure increase of 1/2 stop. While the black net 2 has a approximate exposure increase of 1 stop.



without filter



with Black Net 1 filter



with White Net filter

|                                 |                          |             |              |
|---------------------------------|--------------------------|-------------|--------------|
| <b>Black Net 1</b>              | <b>4x4" Resin Filter</b> | (#LEBN144)  | <b>54.95</b> |
| <b>Black Net 2</b>              | <b>4x4" Resin Filter</b> | (#LEBN244)  | <b>54.95</b> |
| <b>Black Net 3</b>              | <b>4x4" Resin Filter</b> | (#LEBN344)  | <b>54.95</b> |
| <b>White Net 1</b>              | <b>4x4" Resin Filter</b> | (#LEWN144)  | <b>54.95</b> |
| <b>White Net 2</b>              | <b>4x4" Resin Filter</b> | (#LEWN244)  | <b>54.95</b> |
| <b>White Net 3</b>              | <b>4x4" Resin Filter</b> | (#LEWN344)  | <b>54.95</b> |
| <b>Flesh Net</b>                | <b>4x4" Resin Filter</b> | (#LEFN44)   | <b>54.95</b> |
| <b>Flesh Net w/Clear Spot</b>   | <b>4x6" Resin Filter</b> | (#LEFNCS46) | <b>48.95</b> |
| <b>Black Net 1 w/Clear Spot</b> | <b>4x6" Resin Filter</b> | (#LEBNC46)  | <b>48.95</b> |

### Arc Correction Filters (CC/CT)

These filters offer a single filter correction from mercury vapor or high pressure sodium lighting to daylight or tungsten film.

| Filter  | 3x3" Polyester             | 4x4" Polyester              |
|---|----------------------------|-----------------------------|
| <b>HPS-B</b> High Pressure Sodium to Tungsten 3200K | <b>10.95</b><br>(LEHPST33) | <b>15.95</b><br>(LEHPST44Q) |
| <b>MV-B</b> Mercury Vapor to Tungsten 3200K         | <b>10.95</b><br>(LEMVT33)  | <b>15.95</b><br>(LEMVT44Q)  |
| <b>HPS-D</b> High Pressure Sodium to Daylight 5500K | <b>10.95</b><br>(LEHPSD33) | <b>15.95</b><br>(LEHPSD44Q) |
| <b>MV-D</b> Mercury Vapor to Daylight 5500K         | <b>10.95</b><br>(LEMVD33)  | <b>15.95</b><br>(LEMVD44Q)  |



# LEE FILTERS

## FILTERS

### Sepia Filters



without filter



with Sepia 2 (and ND 0.75) filter

Sepia 4 x 4" resin filters give an overall nostalgic, "turn of the century", look to otherwise ordinary color photographs by tinting them with an antique (brownish) hue. They come in three grades with #3 having the strongest tint.

|                  |                   |           |       |
|------------------|-------------------|-----------|-------|
| Sepia 1 (1-stop) | 4x4" Resin Filter | (#LES144) | 74.95 |
| Sepia 2 (2-stop) | 4x4" Resin Filter | (#LES244) | 74.95 |
| Sepia 3 (3-stop) | 4x4" Resin Filter | (#LES344) | 74.95 |

### Tobacco & Antique Suede

Used to accentuate trees, earth and stone, Tobacco is darker and redder than chocolate or sepia, a very strong effect. Like Tobacco, Antique Suede is used to accentuate trees, earth and stone. However, it is lighter and gives a more understated effect.

|                 |                   |            |       |
|-----------------|-------------------|------------|-------|
| Tobacco 1       | 4x4" Resin Filter | (# )       | 74.95 |
| Tobacco 2       | 4x4" Resin Filter | (# )       | 74.95 |
| Tobacco 3       | 4x4" Resin Filter | (# )       | 74.95 |
| Antique Suede 1 | 4x4" Resin Filter | (#LEAS144) | 74.95 |
| Antique Suede 2 | 4x4" Resin Filter | (#LEAS244) | 74.95 |
| Antique Suede 3 | 4x4" Resin Filter | (#LEAS344) | 74.95 |
| Antique Suede 3 | 4x4" Resin Filter | (#LEAS444) | 74.95 |

### Soft Focus Filter



without filter



with Soft Focus filter

The Soft Focus glass filter adds a medium amount of beautiful softness, without losing focus. It is great for portraits, products and landscapes, and adds mood by reducing both sharpness and contrast. It is designed to fit the Lee system filter holder, slotted hoods or Gel Snap filter holder. Includes a durable storage pouch.

|            |                   |      |      |
|------------|-------------------|------|------|
| Soft Focus | 4x4" Glass Filter | (# ) | Call |
|------------|-------------------|------|------|

### Tri-Color Filters

**Tri-Color Red:** This red filter is ideal for strong contrast improvement since it absorbs green and blue completely and enhances red. Clouds are dramatically improved almost to the mood of a thunderstorm. It is more effective in cutting through haze, and moonlight effects are easily accomplished. It is also suited for infrared photography. Filter factor is 2½ to 3 stops.

**Tri-Color Blue:** A deep blue filter that accentuates haze and fog. Also used in dye transfer printing and for contrast effects (lightens blue tones). Filter factor is 2½ to 3 stops.

**Tri-Color Green:** A green filter that produces very light foliage on black and white film. Also used for contrast effects (lightens green/darkens red). Filter factor is 2½ to 3 stops.

| Filter    | 3x3" Polyester  | 4x4" Polyester   | 4x4" Resin     |
|-----------|-----------------|------------------|----------------|
| Red #25   | 13.95 (LE2533)  | 23.95 (LE2544Q)  | 69.95 (LE2544) |
| Blue #47  | 13.95 (LE47B33) | 23.95 (LE47B44Q) | —              |
| Green #58 | 13.95 (LE5833)  | 23.95 (LE47B44Q) | —              |

### Coral Warming Filters



without filter



with Coral 14 top and Sky Blue 5 bottom

Coral Warming filters are general purpose warming filters which come in increasing amounts of color temperature correction as the number in the series increases. They are commonly used to produce slightly "orange" skies. From light to heavy, any effect from basic correction to warmer or cooler than "normal" is possible. Corals can also compensate for the overly cool blue effect of outdoor shade.

**Coral Filters convert 5500° Kelvin to the value shown next to the filter**

|         |                 |       |          |                  |       |
|---------|-----------------|-------|----------|------------------|-------|
| Coral 1 | 4545°K (LEC144) | 49.95 | Coral 8  | 3076°K (LEC844)  | 49.95 |
| Coral 2 | 4255°K (LEC244) | 49.95 | Coral 9  | 2941°K (LEC944)  | 49.95 |
| Coral 3 | 4000°K (LEC344) | 49.95 | Coral 10 | 2817°K (LEC1044) | 49.95 |
| Coral 4 | 3774°K (LEC444) | 49.95 | Coral 11 | 2703°K (LEC1144) | 49.95 |
| Coral 5 | 3570°K (LEC544) | 49.95 | Coral 12 | 2597°K (LEC1244) | 49.95 |
| Coral 6 | 3390°K (LEC644) | 49.95 | Coral 13 | 2500°K (LEC1344) | 49.95 |
| Coral 7 | 3225°K (LEC744) | 49.95 | Coral 14 | 2409°K (LEC1444) | 49.95 |



# LEE FILTERS

## GRADUATED FILTERS

Lee graduated resin filters are 4 x 6" (100 x 150mm) x 2mm thick. The 6" length allows for adjustment of the filter within the holder. Graduated filters feature an area of color at one end of the resin, with the opposite end remaining clear, which enables the color or effect to be placed in a specific area of the frame. By positioning the filter either up or down in the holder, you can balance the light intensity in one part of a scene with another. This is especially helpful in situations where you don't have total light control, as in bright contrasty landscapes. Sometimes it is also desirable to add color to part of the photograph. The transition from color to clear can be fast (hard grad), slow (soft grad) or blended (transition is across the entire length of the filter). Lee's graduated filters with hard edge, soft edge, and blender varieties are designated by H, S, B. The soft edge is recommended for wide angle lenses and the hard edge is recommended for normal and longer lenses.



without filter

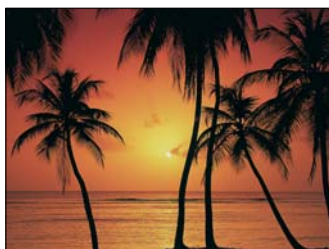

with Graduated Sunset filter



without filter



with Graduated Mahogany 3 filter

**Graduated Blue:** A deep reddish blue, mainly for color effects. Available in grades 1-5 as well as hard or soft gradation. Insert S for soft or H for hard in the parenthesis after the grade #.

|        |                   |              |       |
|--------|-------------------|--------------|-------|
| Blue 1 | 4x6" Resin Filter | #LEGSB1( )46 | 59.95 |
| Blue 2 | 4x6" Resin Filter | #LEGSB2( )46 | 59.95 |
| Blue 3 | 4x6" Resin Filter | #LEGSB3( )46 | 59.95 |
| Blue 4 | 4x6" Resin Filter | #LEGSB4( )46 | 59.95 |
| Blue 5 | 4x6" Resin Filter | #LEGSB5( )46 | 59.95 |

**Graduated Sky Blue:** A greenish blue to add realistic color to flat skies. Available in grades 1-5 as well as hard or soft gradation. Insert S for soft or H for hard in the parenthesis after the grade #.

|            |                   |              |       |
|------------|-------------------|--------------|-------|
| Sky Blue 1 | 4x6" Resin Filter | #LEGSB1( )46 | 59.95 |
| Sky Blue 2 | 4x6" Resin Filter | #LEGSB2( )46 | 59.95 |
| Sky Blue 3 | 4x6" Resin Filter | #LEGSB3( )46 | 59.95 |
| Sky Blue 4 | 4x6" Resin Filter | #LEGSB4( )46 | 59.95 |
| Sky Blue 5 | 4x6" Resin Filter | #LEGSB5( )46 | 59.95 |

### Graduated Real Blue:

Darker and blacker than Sky Blue, gives a deeper effect to skies. Available in grades 1-3 as well as hard or soft gradation. Insert S for soft or H for hard in the parenthesis after the grade #.

|             |                   |              |       |
|-------------|-------------------|--------------|-------|
| Real Blue 1 | 4x6" Resin Filter | #LEGRB1( )46 | 59.95 |
| Real Blue 2 | 4x6" Resin Filter | #LEGRB2( )46 | 59.95 |
| Real Blue 3 | 4x6" Resin Filter | #LEGRB3( )46 | 59.95 |

### Graduated Red:

Available in grades 1-5 as well as hard or soft gradation. Insert S for soft or H for hard in the parenthesis after the grade #.

|       |                   |             |       |
|-------|-------------------|-------------|-------|
| Red 1 | 4x6" Resin Filter | #LEGR1( )46 | 59.95 |
| Red 2 | 4x6" Resin Filter | #LEGR2( )46 | 59.95 |
| Red 3 | 4x6" Resin Filter | #LEGR3( )46 | 59.95 |
| Red 4 | 4x6" Resin Filter | #LEGR4( )46 | 59.95 |
| Red 5 | 4x6" Resin Filter | #LEGR5( )46 | 59.95 |

### Graduated Magenta:

Available in grades 1-5 as well as hard or soft gradation. Insert S for soft or H for hard in the parenthesis after the grade #.

|           |                   |             |       |
|-----------|-------------------|-------------|-------|
| Magenta 1 | 4x6" Resin Filter | #LEGM1( )46 | 59.95 |
| Magenta 2 | 4x6" Resin Filter | #LEGM2( )46 | 59.95 |
| Magenta 3 | 4x6" Resin Filter | #LEGM3( )46 | 59.95 |
| Magenta 4 | 4x6" Resin Filter | #LEGM4( )46 | 59.95 |
| Magenta 5 | 4x6" Resin Filter | #LEGM5( )46 | 59.95 |

### Graduated Sepia:

Gives a brown tinted monochrome look, less red than chocolate. Available in grades 1-3 as well as hard or soft gradation. Insert S for soft or H for hard in the parenthesis after the grade #.

|         |                   |             |       |
|---------|-------------------|-------------|-------|
| Sepia 1 | 4x6" Resin Filter | #LEGS1( )46 | 68.00 |
| Sepia 2 | 4x6" Resin Filter | #LEGS2( )46 | 68.00 |
| Sepia 3 | 4x6" Resin Filter | #LEGS3( )46 | 68.00 |

## GRADUATED FILTERS



without filter



with Real Blue 2 top and Straw 3 bottom

### Graduated Straw:

A greater yellow warm-up for landscapes. Accentuates foregrounds when inverted. Available in grades 1-3 and hard or soft gradation. Insert S (soft) or H (hard) in the parenthesis after grade #.

|         |                   |              |       |
|---------|-------------------|--------------|-------|
| Straw 1 | 4x6" Resin Filter | #LEGST1( )46 | 49.95 |
| Straw 2 | 4x6" Resin Filter | #LEGST2( )46 | 49.95 |
| Straw 3 | 4x6" Resin Filter | #LEGST5( )46 | 49.95 |

### Graduated Yellow:

Available in hard (H) or soft (S) gradation.

|                  |                   |          |       |
|------------------|-------------------|----------|-------|
| Yellow Soft Edge | 4x6" Resin Filter | #LEGYS46 | 59.95 |
| Yellow Hard Edge | 4x6" Resin Filter | #LEGYH46 | 59.95 |

### Graduated Sunset:

Gives a sunset effect, which is ideal when shooting into a low sun. Available in grades 1-3

|          |                   |           |       |
|----------|-------------------|-----------|-------|
| Sunset 1 | 4x6" Resin Filter | #LEGSS146 | 75.95 |
| Sunset 2 | 4x6" Resin Filter | #LEGSS246 | 75.95 |
| Sunset 3 | 4x6" Resin Filter | #LEGSS346 | 75.95 |

### Graduated Sunset Yellow:

The yellow portion of the sunset gradation. Available in hard (H) or soft (S) gradation.

|                         |                   |            |       |
|-------------------------|-------------------|------------|-------|
| Sunset Yellow Soft Edge | 4x6" Resin Filter | #LEGSSYS46 | 59.95 |
| Sunset Yellow Hard Edge | 4x6" Resin Filter | #LEGSSYH46 | 59.95 |

### Graduated Sunset Orange:

The orange portion of the sunset gradation. Available in hard (H) or soft (S) gradation.

|                         |                   |            |       |
|-------------------------|-------------------|------------|-------|
| Sunset Orange Soft Edge | 4x6" Resin Filter | #LEGSSOS46 | 59.95 |
| Sunset Orange Hard Edge | 4x6" Resin Filter | #LEGSSOH46 | 59.95 |

### Graduated Sunset Red:

The red portion of the sunset gradation. Available in hard (H) or soft (S) gradation.

|                      |                   |            |       |
|----------------------|-------------------|------------|-------|
| Sunset Red Soft Edge | 4x6" Resin Filter | #LEGSSRS46 | 59.95 |
| Sunset Red Hard Edge | 4x6" Resin Filter | #LEGSSRH46 | 59.95 |

**Graduated Pop:** Available in blue, green and red, these filters can be accurately placed by using the rotational feature of the holder system, or by vertical positioning within the filter guides. Available in H (hard) or S (soft) gradation.

|           |                   |             |       |
|-----------|-------------------|-------------|-------|
| Pop Blue  | 4x6" Resin Filter | #LEGPB( )46 | 56.50 |
| Pop Red   | 4x6" Resin Filter | #LEGPR( )46 | 56.50 |
| Pop Green | 4x6" Resin Filter | #LEPGP( )46 | 56.50 |

### Graduated Chocolate:

Accentuates autumn leaves, stone, etc. Available in grades 1-5 as well as hard or soft gradation. Insert S for soft or H for hard in the parenthesis after the grade #.



without filter



with Chocolate 2 filter

|             |                   |              |       |
|-------------|-------------------|--------------|-------|
| Chocolate 1 | 4x6" Resin Filter | #LEGCH1( )46 | 69.95 |
| Chocolate 2 | 4x6" Resin Filter | #LEGCH2( )46 | 69.95 |
| Chocolate 3 | 4x6" Resin Filter | #LEGCH3( )46 | 69.95 |
| Chocolate 4 | 4x6" Resin Filter | #LEGCH4( )46 | 69.95 |
| Chocolate 5 | 4x6" Resin Filter | #LEGCH5( )46 | 69.95 |

### Graduated Pink, Cyan and Green:

Available in hard or soft gradation. Insert S for soft or H for hard in the parenthesis.

|         |                   |             |       |
|---------|-------------------|-------------|-------|
| Pink    | 4x6" Resin Filter | #LEGP( )46  | 59.95 |
| Pink 1  | 4x6" Resin Filter | #LEGP1( )46 | 59.95 |
| Cyan    | 4x6" Resin Filter | #LEGC( )46  | 59.95 |
| Cyan 1  | 4x6" Resin Filter | #LEGC1( )46 | 59.95 |
| Green   | 4x6" Resin Filter | #LEGR( )46  | 59.95 |
| Green 1 | 4x6" Resin Filter | #LEGR1( )46 | 59.95 |

### Graduated Mahogany:

Gives an evening and dawn effect to skies. A good "Red sky at night" effect. Available in grades 1-3 and hard or soft gradation. Insert S for soft or H for hard in the parenthesis.

|            |                   |              |       |
|------------|-------------------|--------------|-------|
| Mahogany 1 | 4x6" Resin Filter | #LEGM1( )46Q | 68.00 |
| Mahogany 2 | 4x6" Resin Filter | #LEGM2( )46Q | 68.00 |
| Mahogany 3 | 4x6" Resin Filter | #LEGM3( )46Q | 68.00 |



## GRADUATED FILTERS

**Graduated Twilight:** Deep blue/black gives a monochromatic twilight look. Available in hard (H) or soft (S) gradation.

|                           |                          |           |              |
|---------------------------|--------------------------|-----------|--------------|
| <b>Twilight Soft Edge</b> | <b>4x6" Resin Filter</b> | #LEGTLS46 | <b>59.95</b> |
| <b>Twilight Hard Edge</b> | <b>4x6" Resin Filter</b> | #LEGLH46  | <b>59.95</b> |

### Graduated Tobacco:

Darker and redder than chocolate or sepia, a very strong effect. Available in grades 1-3 as well as hard or soft gradation. Insert S for soft or H for hard in the parenthesis after the grade #.



without filter



with Graduated Tobacco

|                  |                          |              |              |
|------------------|--------------------------|--------------|--------------|
| <b>Tobacco 1</b> | <b>4x6" Resin Filter</b> | #LEGTO1( )46 | <b>68.00</b> |
| <b>Tobacco 2</b> | <b>4x6" Resin Filter</b> | #LEGTO2( )46 | <b>68.00</b> |
| <b>Tobacco 3</b> | <b>4x6" Resin Filter</b> | #LEGTO3( )46 | <b>68.00</b> |

### Graduated Neutral Density (ND) Filters

Lee's range of true, neutral density (ND) graduated filters enables the photographer to selectively adjust exposure across the frame without affecting the color balance. Available in half-stop increments from 1 to 3 stops and with a choice of hard, soft and blended gradation, these filters can be used singularly or in combination to provide a variety of effects - the only limit is the extent your imagination! Insert S for soft, H for hard or B for blended in the parenthesis after the grade #.



without filter



with ND 0.6 filter

|               |                          |                |              |
|---------------|--------------------------|----------------|--------------|
| <b>.3 ND</b>  | <b>4x6" Resin Filter</b> | #LEGND.3( )46  | <b>69.95</b> |
| <b>.45 ND</b> | <b>4x6" Resin Filter</b> | #LEGND.45( )46 | <b>69.95</b> |
| <b>.6 ND</b>  | <b>4x6" Resin Filter</b> | #LEGND.6( )46  | <b>69.95</b> |
| <b>.75 ND</b> | <b>4x6" Resin Filter</b> | #LEGND.75( )46 | <b>69.95</b> |
| <b>.9 ND</b>  | <b>4x6" Resin Filter</b> | #LEGND.9( )46  | <b>69.95</b> |

### Graduated Warming + ND Filters

Lee combination filters are like two filters in one. They combine graduated 85, 85B and 81EF Color Conversion filters with a 0.3, 0.6 or 0.9 grey neutral density filter with soft or hard edges.

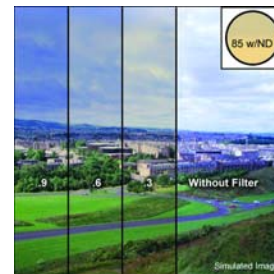

| 4x6" 85/ND Combination Graduated Warming Filters |               |               |
|--|---------------|---------------|
| <b>85 with .3 ND Soft Edge</b>                   | #LEG85ND.3S4Q | <b>109.95</b> |
| <b>85 with .6 ND Soft Edge</b>                   | #LEG85ND.6S4Q | <b>109.95</b> |
| <b>85 with .9 ND Soft Edge</b>                   | #LEG85ND.9S4Q | <b>109.95</b> |
| <b>85 with .3 ND Hard Edge</b>                   | #LEG85ND.3H46 | <b>109.95</b> |
| <b>85 with .6 ND Hard Edge</b>                   | #LEG85ND.6H46 | <b>109.95</b> |
| <b>85 with .9 ND Hard Edge</b>                   | #LEG85ND.9H46 | <b>109.95</b> |
| <b>85 to .3 ND Hard Edge</b>                     | #LEG85ND.3H4Q | <b>109.95</b> |
| <b>85 to .6 ND Hard Edge</b>                     | #LEG85ND.6H4Q | <b>109.95</b> |
| <b>85 to .9 ND Hard Edge</b>                     | #LEG85ND.9H4Q | <b>109.95</b> |

| 4x6" 85B/ND Combination Graduated Warming Filters |               |               |
|---|---------------|---------------|
| <b>85B with .3 ND Soft Edge</b>                   | #LEG85BND.3S4 | <b>109.95</b> |
| <b>85B with .6 ND Soft Edge</b>                   | #LEG85BND.6S4 | <b>109.95</b> |
| <b>85B with .9 ND Soft Edge</b>                   | #LEG85BND.9S4 | <b>109.95</b> |
| <b>85B with .3 ND Hard Edge</b>                   | #LEG85BND.3H4 | <b>109.95</b> |
| <b>85B with .6 ND Hard Edge</b>                   | #LEG85BND.6H4 | <b>109.95</b> |
| <b>85B with .9 ND Hard Edge</b>                   | #LEG85BND.9H4 | <b>109.95</b> |
| <b>85B to .3 ND Hard Edge</b>                     | #LEG85BND.3HQ | <b>109.95</b> |
| <b>85B to .6 ND Hard Edge</b>                     | #LEG85BND.6HQ | <b>109.95</b> |
| <b>85B to .9 ND Hard Edge</b>                     | #LEG85BND.9HQ | <b>109.95</b> |

| 4x6" 81EF/ND Combination Graduated Warming Filters |               |               |
|--|---------------|---------------|
| <b>81EF with .3 ND Soft Edge</b>                   | #LEG81EFND.3S | <b>109.95</b> |
| <b>81EF with .6 ND Soft Edge</b>                   | #LEG81EFND.6S | <b>109.95</b> |
| <b>81EF with .9 ND Soft Edge</b>                   | #LEG81EFND.9S | <b>109.95</b> |
| <b>81EF with .3 ND Hard Edge</b>                   | #LEG81EFND.3H | <b>109.95</b> |
| <b>81EF with .6 ND Hard Edge</b>                   | #LEG81EFND.6H | <b>109.95</b> |
| <b>81EF with .9 ND Hard Edge</b>                   | #LEG81EFND.9H | <b>109.95</b> |
| <b>81EF to .3 ND Hard Edge</b>                     | #LEG81EFND.3Z | <b>109.95</b> |
| <b>81EF to .6 ND Hard Edge</b>                     | #LEG81EFND.6Z | <b>109.95</b> |
| <b>81EF to .9 ND Hard Edge</b>                     | #EG81EFND.9Z  | <b>109.95</b> |



## GRADUATED FILTERS

### Graduated Coral Warming Filters



without filter

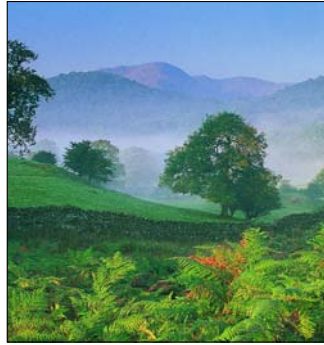

with Coral 4 filter

Coral filters are pinkish warming filters (redder than the 81 series) which come in increasing amounts of color temperature correction as the number in the series increases. They are commonly used to produce slightly “orange” skies. Corals can also compensate for the overly cool blue effect of outdoor shade. (See Lee’s Coral Filter Color Temperature Conversion Chart on page 432).

Coral Warming filter are available in grades 1 to 14, as well as hard, soft or blended graduation. Insert S for soft, H for hard or B for blended in the parenthesis after the grade #.

|          |                   |              |       |
|----------|-------------------|--------------|-------|
| Coral 1  | 4x6" Resin Filter | #LEGC1( )46  | 59.95 |
| Coral 2  | 4x6" Resin Filter | #LEGC2( )46  | 59.95 |
| Coral 3  | 4x6" Resin Filter | #LEGC3( )46  | 59.95 |
| Coral 4  | 4x6" Resin Filter | #LEGC4( )46  | 59.95 |
| Coral 5  | 4x6" Resin Filter | #LEGC5( )46  | 59.95 |
| Coral 6  | 4x6" Resin Filter | #LEGC6( )46  | 59.95 |
| Coral 7  | 4x6" Resin Filter | #LEGC7( )46  | 59.95 |
| Coral 8  | 4x6" Resin Filter | #LEGC8( )46  | 59.95 |
| Coral 9  | 4x6" Resin Filter | #LEGC9( )46  | 59.95 |
| Coral 10 | 4x6" Resin Filter | #LEGC10( )46 | 59.95 |
| Coral 11 | 4x6" Resin Filter | #LEGC11( )46 | 59.95 |
| Coral 12 | 4x6" Resin Filter | #LEGC12( )46 | 59.95 |
| Coral 13 | 4x6" Resin Filter | #LEGC13( )46 | 59.95 |

### Mist Filters

Available individually or in a set, the Mist filters create varying densities of mist and fog. The Mist Stripe can often be used to cover the foreground of the shot, providing a feeling of depth of fog, while the Mist Clear Spot allows the viewers eye to be taken straight to the all-important subject.

|                 |                   |          |       |
|-----------------|-------------------|----------|-------|
| Mist Grad       | 4x6" Resin Filter | #LEMG46  | 55.00 |
| Mist Stripe     | 4x6" Resin Filter | #LEMS46Q | 74.95 |
| Mist Clear Spot | 4x6" Resin Filter | #LEMCS46 | 55.00 |

### Graduated Stripes

Available in eleven colors, the stripe filter has a stripe of color placed horizontally across the center of the filter. This enables the color to be positioned anywhere in the frame, either by rotating the filter holder or by sliding the filter up or down in the holder guides. This set is ideal for creating special effects. The stripe - due to its position on the actual filter - allows itself to be positioned from the lowest point in the frame to the highest.



without filter



with Coral Stripe filter

|                   |                   |          |       |
|-------------------|-------------------|----------|-------|
| Sunset Stripe     | 4x6" Resin Filter | #LESSS46 | 75.95 |
| Blue Stripe       | 4x6" Resin Filter | #LEBLS46 | 75.95 |
| Red Stripe        | 4x6" Resin Filter | #LERS46  | 75.95 |
| Yellow Stripe     | 4x6" Resin Filter | #LEYS46  | 75.95 |
| Magenta Stripe    | 4x6" Resin Filter | #LEMS46Z | 75.95 |
| Green Stripe      | 4x6" Resin Filter | #LEGRS46 | 75.95 |
| Coral Stripe      | 4x6" Resin Filter | #LECS46Z | 75.95 |
| Pale Coral Stripe | 4x6" Resin Filter | #LEPCS46 | 75.95 |
| Straw Stripe      | 4x6" Resin Filter | #LESTS46 | 75.95 |
| Pink Stripe       | 4x6" Resin Filter | #LEPS46Q | 75.95 |
| Mist Stripe       | 4x6" Resin Filter | #LEMS46Q | 75.95 |

### Graduated Star Filters

Available individually or in a set, these filters make it possible to create star effects on highlights in various parts of the frame. The Star Spot (4pt), has a circular cluster of markings to create stars, while the Star Segment (8pt) will place highlights in a chosen position of the shot. The Star Graduate (6pt) makes highlights at one end of the filter, reducing to clear resin at the other.



with 6 pt. Star filter

|              |                   |           |       |
|--------------|-------------------|-----------|-------|
| 8-Point Star | 4x6" Resin Filter | #8STSEG-G | 75.00 |
| 6-Point Star | 4x6" Resin Filter | #6ST-G    | 75.00 |
| 4-Point Star | 4x6" Resin Filter | #4STSP-G  | 75.00 |

# GRADUATED RESIN & POLYESTER FILTER SETS

**Starter Set (LENDSS):** Versatile and practical filtration tools. Includes .6ND grad soft, 81B warming filter and circular polarizer .....**262.50**

**Sky Set (LESS46):** Enhance sky tones in landscapes, seascapes, and general outdoor photography. Includes soft grad Sunset 2, hard Coral Stripe and Sky Blue 3 .....**114.95**

**Sky-2 Set (LESS46Q):** Enhancement for any sky. Includes .6ND grad soft, hard edge Sky Blue 3 and Coral 6 .....**114.95**

**Neutral Density Set (LEGNDS46):** This set can be used with all standard film types and contains a hard edge graduated 0.3, 0.6 and 0.9ND enabling the photographer to adjust exposure over part of the photograph without affecting the color balance .....**191.95**

**Neutral Density Soft Set (LENDGSS):** Neutral density grad set for precise exposure balance. Same as above, except it includes a graduated soft .3ND, .6ND and .9ND and storage pouch.....**179.95**



chocolate 2

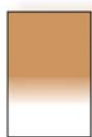

tobacco 2

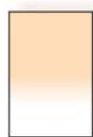

coral 6

**Autumn Tint Set (LEAS46):** Used to create atmospheric autumnal effects, this set includes Tobacco 2, Coral 6 and Chocolate 2 grad hard filters .....**114.95**

**Landscape Set (LELS46):** Designed to compliment the landscape, whether rural, suburban or busy city center. Includes graduated hard edge Real Blue 2, Straw 3 and Sepia 2 .....**114.95**

**Sunrise Set (LESRS46):** A set of three bright, warm colors for dawn or sunrise photography. Includes hard edge grad Mahogany 1, Straw 2 and Straw Stripe.....**114.95**

**Twilight Set (LETLS46):** For a more subtle effect the twilight set contains a paler, thinner version of Lee's Coral Stripe filter. It is teamed with a graduated hard Mahogany 3 which gives an ideal "red sky at night" effect, and a graduated hard dark blue Twilight filter for capturing the moment when day finally turns to night.....**114.95**

**Sunset Set (LESSS46Q):** These filters - soft edge grad Sunset Red, Sunset Orange and and Sunset Yellow let you add warmth and definition to both the sky and landscape.....**114.95**

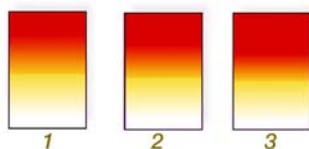

**Color Grad Set (LECS46):** These hard edge grad filters -Cyan, Yellow and Magenta - create special effects and color a chosen section of the image being photographed. Using them in varying combinations, red, blue and green effects can also be created. Additionally, effects can be achieved by using the filters in opposition to each other .....**114.95**

**Pale Tint Set (LEPTS46):** This set comprises the number one grade (palest) from the green, pink and cyan filter ranges. It offers the photographer an opportunity to create truly subtle tints in the chosen areas of the frame by positioning the color through rotation of the filter holder, and by moving the filter up or down.....**114.95**

**Sky Blue Set (LESBS46):** Contains Sky Blue 1, 2, and 3 graduated hard edge filters allowing addition of varying degrees of color to otherwise gray or colorless skies. Ideal for use in land and seascapes .....**114.95**

**Coral Set (LECS46Q):** These three pale to mid-tone hard edge coral grads (2, 4 and 6) can be used as general warm-up filters, or for special effects. Can also be used to create slightly orange skies.....**114.95**

**Pop Set (LEPS46):** This set of hard edge grad filters features three primary colors - red, green and blue - for selective coloring over parts of the frame. These filters are ideal for creating special effects, and can be accurately placed by using the rotational feature of the holder system, or by vertical positioning within the filter guides .....**114.95**

**Mist Set (LEMS46):** This set consists of a Graduated Mist, a Mist Stripe, and a Mist Clear Center Spot. Use individually or in combinations to create varying densities of mist and fog. The stripe can often be used to cover the foreground of the shot, providing a feeling of depth of fog, while the clear centre allows the viewers eye to be taken straight to the all-important subject .....**114.95**

**Selective Star Set (LESS46Q):** This set is made up of a Star Spot filter (4pt), a Star Graduated filter (6pt) and a Star Segment filter (8pt). Using these filters, it is possible to create star effects on highlights in various parts of the frame. ....**114.95**

**Net Set (LENS46):** Based on net filters commonly used in cinematography, these filters provide a subtle soft focus effect while also increasing or decreasing contrast. If required the selective hole can be slid into the frame to provide an unaffected clear center effect. Includes Black Net 1, Black Net 2 and White Net.....**114.95**

**Stripe Set (LESS46H):** Three filters, each with a stripe of yellow, pink and cyan placed horizontally across the center. This enables the color to be positioned anywhere in the frame, either by rotating the filter holder or sliding the filter up or down. ....**114.95**

## Polyester Filter Sets

**Soft Focus Set (LESSZ)**

Based on filters originally developed by Lee for use in film, this set consists of five soft filters that take the image from a subtle, barely noticeable softening to a heavy diffusion. ....**56.95**

**Color Temperature Set (LECTS)**

Includes an 80A, 80C, 85B, and 85C filter.....**56.95**

**Fine Color Temperature Set (LEFCTS)**

Includes an 81A, 81D, 82A and 82C filter .....**56.95**

**Warming Set (LEWSQ)**

Includes 81, 81B, 81D and 85C filters.....**52.50**

**Daylight Fluorescent Set (LEDFS)**

Includes an FL3600, FL4300 and FL5700 .....**56.95**

**Tungsten Fluorescent Set (LETFS)**

Includes an FL3600, FL4300 and FL5600 .....**56.95**

**Neutral Density Set (LENDSS)**

Includes 0.3, 0.6, 0.9ND filters .....**56.95**

## FILTERS

### Rugged Alternative to Gel Filters

Gelatin filters are prone to buckling and dimpling. They're more susceptible to nicks and scratches than any other kind of filter. And they're virtual magnets for dust and grease, yet can't be cleaned! All that means you end up throwing gelatins away when you think their condition might injure the image - or you shoot with a dirty filter and hope for the best.

Optiflex filters put an end to that gamble. Available in 3x3 and 4x4" sizes, in a full range of CC, CTC, ND, and black-and-white types, Optiflex filters are made from the same dyed-through optical resin as rigid Hitech filters- so they deliver the same superior image quality. Yet these filters are just 0.3mm thick. That means they're thin enough for use in gelatin filter holders, but still rigid enough to prevent warping and buckling. Their resin base also makes them much more scratch-resistant than gels. And you can clean them just like a glass filter.



### FEATURES

- ◆ Made from the same dyed-through optical resin base as rigid Hitech filters, but with 0.3mm thickness for use in gelatin filter holders.
- ◆ Optiflex is more durable than gel, cleanable, and can be used in any frame or holder designed for gels. They won't buckle or dimple the way gels can, and their resin base makes them much more scratch-resistant than gelatin or polyester filters.
- ◆ Less expensive than gels.
- ◆ Optiflex filters are just 0.3mm thick and are made to precise technical standards for color compensation and correction as well as neutral density and black-and-white control.
- ◆ Image quality is as good or better than gels and far superior to polyester.
- ◆ Complete range of flexible 0.3mm-thick optical resin filters, dyed-through for superior optical performance. Designed for use in existing gelatin filter holders; available in 3 x 3- and 4 x 4" sizes, in color compensating (CC), color temperature control (CTC), neutral density (ND), and black-and-white types.

### Color Temperature Correction (CTC)

These allow you to balance different light sources with your film. The bluish 80 series converts day-light film for use with tungsten light; the salmon-colored 85 series converts tungsten film for use in daylight. Other CTC filters are made for fine-tuning color balance. The light blue 82 series is mildly cooling; and the amber-colored 81 series produces slight warming.

#### COLOR TEMPERATURE CORRECTION (CTC) FILTERS

| Filter           | Exp.  | Type    | Conversion       | 3x3"   | Price | 4x4"   | Price |
|------------------|-------|---------|------------------|--------|-------|--------|-------|
| 80A Blue         | +2    | Cooling | 3200°K to 5500°K | OP3304 | 19.95 | OP4304 | 34.95 |
| 80B Blue         | +1/23 | Cooling | 3400°K to 5500°K | OP3305 | 19.95 | OP4305 | 34.95 |
| 80C Blue         | +1    | Cooling | 3800°K to 5500°K | OP3306 | 19.95 | OP4306 | 34.95 |
| 80D Blue         | +1/3  | Cooling | 4200°K to 5500°K | OP3307 | 19.95 | OP4307 | 34.95 |
| 82 Light Blue    | +1/3  | Cooling | 3100°K to 3200°K | OP3300 | 19.95 | OP4300 | 34.95 |
| 82A Light Blue   | +1/3  | Cooling | 3000°K to 3200°K | OP3301 | 19.95 | OP4301 | 34.95 |
| 82B Light Blue   | +2/3  | Cooling | 2900°K to 3200°K | OP3302 | 19.95 | OP4302 | 34.95 |
| 82C Light Blue   | +2/3  | Cooling | 2800°K to 3200°K | OP3303 | 19.95 | OP4303 | 34.95 |
| 81 Light Amber   | +1/3  | Warming | 3300°K to 3200°K | OP3200 | 19.95 | OP4200 | 34.95 |
| 81A Light Amber  | +1/3  | Warming | 3400°K to 3200°K | OP3201 | 19.95 | OP4201 | 34.95 |
| 81B Light Amber  | +1/3  | Warming | 3500°K to 3200°K | OP3202 | 19.95 | OP4202 | 34.95 |
| 81C Light Amber  | +1/3  | Warming | 3600°K to 3200°K | OP3203 | 19.95 | OP4203 | 34.95 |
| 81D Light Amber  | +2/3  | Warming | 3700°K to 3200°K | OP3204 | 19.95 | OP4204 | 34.95 |
| 81EF Light Amber | +2/3  | Warming | 3850°K to 3200°K | OP3205 | 19.95 | OP4205 | 34.95 |
| 85 Amber         | +2/3  | Warming | 5500°K to 3400°K | OP3206 | 19.95 | OP4206 | 34.95 |
| 85B Amber        | +2/3  | Warming | 5500°K to 3200°K | OP3207 | 19.95 | OP4207 | 34.95 |
| 85C Amber        | +1/3  | Warming | 5500°K to 3800°K | OP3208 | 19.95 | OP4208 | 34.95 |



For Any Inquiries Regarding Your Order, Call Our Customer Service:  
 (800) 221-5743 • (212) 239-7765 • FAX: (800) 947-2215 • (212) 239-7549



### Neutral Density

Neutral density (ND) filters are a colorless gray and cause an overall reduction in the level of light reaching the lens. This is useful for creating creative techniques. In outdoor portraiture, particularly with long lenses, it lets you shoot at wide apertures to soften the background; in landscapes, it lets you use a fast film to create a grainy effect. Optiflex ND filters are available in 6 specific densities (1/3 stop increments up to one stop, and one-stop increments up to 4-stops).

#### 3x3"

- ND 0.1** (OPND.133): 1/3-stop reduction...**27.95**
- ND 0.2** (OPND.233): 2/3-stop reduction...**27.95**
- ND 0.3** (OPND.333): 1-stop reduction .....**27.95**
- ND 0.6** (OPND.633): 2-stop reduction .....**27.95**
- ND 0.9** (OPND.933): 3-stop reduction .....**27.95**
- ND 1.2** (OPND1.233): 4-stop reduction.....**27.95**

#### 4x4"

- ND 0.1** (OPND.144): 1/3-stop reduction...**44.95**
- ND 0.2** (OPND.244): 2/3-stop reduction...**44.95**
- ND 0.3** (OPND.344): 1-stop reduction .....**44.95**
- ND 0.6** (OPND.644): 2-stop reduction .....**44.95**
- ND 0.9** (OPND.944): 3-stop reduction .....**44.95**
- ND 1.2** (OPND1.244): 4-stop reduction.....**44.95**

### Color Compensating (CC)

Also used in printing, these filters are designed for fine-tuning color balance. Available in densities of from .025 to .50 (including a rare and useful .15), in the customary yellow, magenta, cyan, red, green, and blue.



#### 3 x 3" COLOR CONVERSION (CC) FILTERS

| Density | .025 | .05  | .10  | .15  | .20  | .30  | .40  | .50  | Item #     | Price |
|---------|------|------|------|------|------|------|------|------|------------|-------|
| Yellow  | nil  | nil  | +1/3 | +1/3 | +1/3 | +1/3 | +1/3 | +2/3 | OPCC( )Y33 | 19.95 |
| Magenta | nil  | +1/3 | +1/3 | +1/3 | +1/3 | +2/3 | +2/3 | +2/3 | OPCC( )M33 | 19.95 |
| Cyan    | nil  | +1/3 | +1/3 | +1/3 | +1/3 | +2/3 | +2/3 | +1   | OPCC( )C33 | 19.95 |
| Red     | nil  | +1/3 | +1/3 | +1/3 | +1/3 | +2/3 | +2/3 | +1   | OPCC( )R33 | 19.95 |
| Green   | nil  | +1/3 | +1/3 | +1/3 | +1/3 | +2/3 | +2/3 | +1   | OPCC( )G33 | 19.95 |
| Blue    | nil  | +1/3 | +1/3 | +1/3 | +2/3 | +2/3 | +1   | +1½  | OPCC( )B33 | 19.95 |

#### 4 x 4" COLOR CONVERSION (CC) FILTERS

| Density | .025 | .05  | .10  | .15  | .20  | .30  | .40  | .50  | Item #     | Price |
|---------|------|------|------|------|------|------|------|------|------------|-------|
| Yellow  | nil  | nil  | +1/3 | +1/3 | +1/3 | +1/3 | +1/3 | +2/3 | OPCC( )Y44 | 34.95 |
| Magenta | nil  | +1/3 | +1/3 | +1/3 | +1/3 | +2/3 | +2/3 | +2/3 | OPCC( )M44 | 34.95 |
| Cyan    | nil  | +1/3 | +1/3 | +1/3 | +1/3 | +2/3 | +2/3 | +1   | OPCC( )C44 | 34.95 |
| Red     | nil  | +1/3 | +1/3 | +1/3 | +1/3 | +2/3 | +2/3 | +1   | OPCC( )R44 | 34.95 |
| Green   | nil  | +1/3 | +1/3 | +1/3 | +1/3 | +2/3 | +2/3 | +1   | OPCC( )G44 | 34.95 |
| Blue    | nil  | +1/3 | +1/3 | +1/3 | +2/3 | +2/3 | +1   | +1½  | OPCC( )B44 | 34.95 |

## Black-and-White

These traditional filters give black-and-white photographers a high degree of creative control over an image's tonal values, and their use can prevent printing problems and enhance dark-room technique. Use them to reduce or eliminate atmospheric haze, to make more natural tonal reproduction in monochrome photographs, and to give deliberate emphasis to certain objects.

The yellow-to-red range is often used for outdoor and landscape photography, increasing effective contrast by reducing haze and progressively darkening blue sky. Yellow simply restores sky areas (otherwise rendered too light by the film's high sensitivity to blue) to a middle tone, creating a natural-looking contrast with clouds; orange and red filters make sky darker than it normally appears, so that clouds stand out more dramatically. Green and yellow-green filters lighten foliage and slightly darken a blue sky. Light blue and blue filters correct tonal reproduction under tungsten light.

#### #8 Yellow:

Greatly increases contrast and is particularly useful for mid-day sun and deep shadows. Accentuates clouds, considerably reduces haze and reproduces distance better.

**3x3" #8 Yellow** (OP833).....**19.95**

**4x4" #8 Yellow** (OP844).....**34.95**

#### #11 Yellow-Green:

Retains tonal values, but reduces haze and brightens green.

**3x3" #11 Yellow-Green** (OP1133) .....**19.95**

**4x4" #11 Yellow-Green** (OP1144) .....**34.95**

#### #21 Orange:

Accentuates red picture parts set off against green or blue. For example, it will make clouds brighter against the sky.

**3x3" #21 Orange** (OP2133) .....**19.95**

**4x4" #21 Orange** (OP2144) .....**34.95**

#### #25 Red:

Suppresses blue and brightens red. Also suppresses red lettering, red stamps, etc.

**3x3" #21 Orange** (OP2533) .....**19.95**

**4x4" #21 Orange** (OP2544) .....**34.95**

#### #38 Light Blue:

Corrects the tendency of reds to reproduce too lightly under tungsten lighting; when used for portraits, skin tones are more natural and modeling is improved.

**3x3" #38 Light Blue** (OP3833) .....**19.95**

**4x4" #38 Light Blue** (OP3844) .....**34.95**

#### #47 Blue:

Accentuates haze and fog, creating dense, moody atmospheric effects in landscape and marine scenes.

**3x3" #47 Blue** (OP4733).....**Call**

**4x4" #47 Blue** (OP4744).....**Call**

# SINGH-RAY

## FILTERS FOR COKIN SERIES 'P'

### CIRCULAR POLARIZERS

FILTERS

406

#### **Circular Polarizer/Neutral Filter** (SICPCP)

Polarizing filters remove unwanted reflections from non-metallic surfaces such as water or glass and also saturate colors providing better contrast. Circular polarizers are specifically designed for use with auto-focus SLR cameras. They ensure TTL (through-the-lens metering) accuracy while removing glare and reflections. The effect can be seen through the viewfinder and changed by rotating the filter. The filter factor varies according to how the filter is rotated and its orientation to the sun. Filter factor is between 2.3 and 2.8 (approximately +1.3 stops).....159.95

#### **Circular Polarizer/A-13 Warming Filter** (SICPWCP)



without filter



with A-13 Warming Filter

Combines all the benefits of a circular polarizer with the warming effect of an A-13 Warming Filter.....159.95

#### **Circular Polarizer/B-9 UV Correction Filter** (SICPUVCP)

Unique B-9 UV-correcting filter with color-neutral circular polarizer helps preserve natural flesh tones while keeping white areas white. Developed to correct ultraviolet effects and color shifts due to electronic flash, this combination is equally useful indoors or outdoors, especially for flash-fill close-ups.....159.95

#### **Circular Polarizer/Color Intensifier Glass Filter** (SICPCICP)

Combines all the benefits of a circular polarizer with an Intensifier Polarizer to "punch" colors for a dramatic yet natural effect. Get the combined effect of two filters in a single glass thickness.....339.95

#### **Gold-N-Blue Polarizer** (SIPGBCP)

The Gold-N-Blue is a bi-color polarizing filter that changes the chromatic emphasis between two colors as it is rotated. This allows it to offer you the ability to add dramatic color to a scene, even when the daylight is less than inspirational. Just rotate the Gold-N-Blue Polarizer to see the change from golden yellows to dramatic blue tones, even without strong direct sunlight. Then just choose the degree that suits your taste. The polarized color effects are strongest when the axis of your lens is directed 90° away from the direction of sunlight. The least effect is seen when shooting toward the sun. The reduction in exposure value (filter factor) is similar to other polarizers; 2 to 2½ stops. Through-the-lens (TTL) meters have no trouble providing accurate automatic exposures.....180.95



#### **Red Ray Polarizing Filter**

This polarizer is formulated to accentuate the red areas in a scene where strong sunlight is falling on the subject from the side.....Call

#### **Sunset Warming Glass Filter** (SISSWCP)

Often it is necessary or desirable to balance the light intensity in one part of a scene with another. This is especially true in situations where you don't have total light control, as in bright contrasty landscapes. Sometimes it is also desirable to add color to part of the photograph. For example, to add warmth to the sky.....119.95

#### **A-13 Warming Filter** (SIWCP)

The A-13 Warming Filter compensates for the blue tendencies of many films. 84 x 120mm length allows you to position horizontally anywhere in your frame.....119.95



For Any Inquiries Regarding Your Order, Call Our Customer Service:  
(800) 221-5743 • (212) 239-7765 • FAX: (800) 947-2215 • (212) 239-7549



## FILTERS FOR COKIN SERIES 'P'

### Color Intensifier (SICICP)

While it doesn't quite "pump" the red in a scene, the results are much more natural and believable (in part because more of the green is preserved). The cleaner rendering of neutral colors and whites is the strongest advantage of the Color Intensifier. By selecting appropriate scenes and bracketing exposures, you can take advantage of the "natural" advantages of this filter. It is especially effective when the scene includes clouds, whitewater, gray rock, aspens, or other bright areas. You can also combine the Color Intensifier with any Graduated Neutral Density filter to give more "realistic" skies. Just be sure to adjust exposure by about 1½ or 2 stops.....159.95



without filter



with Color Intensifier

### Single Color Intensifiers

Singh-Ray's red, blue, and green intensifiers offer targeted enhancement for specific objectives. Use the Red for spring roses, fall foliage, or sunsets. Use the Blue for skies, water, flowers and more. The Green adds that something extra to nature's greenery for optimal results.

**Red Intensifier (SIRICP) .....159.95**    **Blue Intensifier (SIBLICP)....159.95**  
**Green Intensifier (SIGRICP) .....159.95**

### Hi-Lux Filter (SIHLCP)



Singh-Ray's unique filtration formula for the Hi-Lux filter combines front lens element protection along with a slight warming effect – to enhance flesh tones – plus certain special characteristics that assure the best possible color quality, contrast

and edge separation under various lighting conditions--outdoors, indoors, and flash. The filter's warming effect is slightly less than that of an 81-A filter. The visible effects of the Hi-Lux are quite subtle but important for critical work. Improvements are quite often seen in flesh tones – particularly when using electronic fill flash. The Hi-Lux is specifically designed to maintain peak acuity and chromatic clarity for both film and digital images .....119.95

### Strip Filters

Singh-Ray Strip filters are clear with either neutral density stripe, orange stripe, or pink stripe across the 84mm dimension in the center of the filter.

**Neutral Density (ND) Strip (SISNDCP) .....119.95**  
**Orange Strip (SISOCP) .....119.95**  
**Pink Strip (SISPCP).....119.95**

### Graduated ND Filters

Often it is necessary or desirable to balance the light intensity in one part of a scene with another. This is especially true in situations where you don't have total light control, as in bright contrasty landscapes. Exposing for the foreground will produce a washed-out, over-exposed sky while exposing for the sky will leave the foreground dark and under-exposed.



without filter



with Graduated ND

Developed with renowned nature photographer Galen Rowell, Singh-Ray

Grad ND filters are part clear, part neutral density (available in grades of .6 or .9) allowing you to seamlessly "hold back" bright sky 2 or 3 f-stops to balance foreground exposure. The filters are available with soft or hard transitions from dark to clear. The soft edge is recommended for wide angle lenses and the hard edge is recommended for normal and longer lenses.

**Graduated ND Hard-Step 2-Stop (SIGND2HCP) .....98.95**  
**Graduated ND Soft-Step 2-Stop (SIGND2SCP) .....98.95**  
**Graduated ND Hard-Step 3-Stop (SIGND3HCP) .....98.95**  
**Graduated ND Soft-Step 3-Stop (SIGND3SCP) .....98.95**

### Graduated ND Reverse Filters

Singh-Ray Graduated Neutral Density Reverse filters are similar to Stripe filters with the addition of a "reverse" ND gradation extending upwards from the central stripe. Reverse ND filters are available in grades 1-3, with 3 having the greatest effect.

**Graduated ND Reverse 1-Stop (SIGNDR1CP) .....113.95**  
**Graduated ND Reverse 2-Stop (SIGNDR2CP) .....113.95**  
**Graduated ND Reverse 3-Stop (SIGNDR3CP) .....113.95**



## PROTECTION & UV FILTERS

Film is very sensitive to ultraviolet light. This often shows up as a bluish cast in images or as a low-contrast haze that diminishes details. UV filters absorb ultraviolet light without affecting light in the visible region. (Except that of air-borne particles, such as smog which is made up of opaque matter that absorbs visible light as well as UV, and is not removed by a UV filter).

UV filters come in different absorption levels, measured by percentage transmission at 400 nanometers (nm), the visible-UV wavelength boundary. Use a filter that transmits 0% at 400nm, such as the UV Haze-2, for aerial and far-distant scenes; the UV Haze-1, transmitting 29% at 400nm, is fine for average situations. These filters also protect your lens against dust, moisture, fingerprints, scratches and damage. They may be kept on your camera at all times. They are also available in thin filter rings (Wide Angle or W/A) to avoid vignetting when used on wide angle lenses. A clear (colorless) filter which serves as a permanent lens protector is available as well.

**UV Protector:** The most popular protection filter, the UV Protector provides the basic reduction of UV light and is also available as a multi-coated filter, or in thin ring lens mount for wide angle lenses, and in multiple filter kits.

**UV Haze-1:** The best general purpose UV control. It eliminates wash out color and image clarity. It also reduces excessive blue by absorbing almost 3/4 of UV light, and is also available in thin ring lens mount for wide angle lenses.

**UV Haze-2A:** This filter absorbs virtually all UV light. It reduces haze more than the Haze-1. Used in high altitudes and along bodies of water, the Haze 2A is also ideal for aerial shots, mountain scenes and marine scenes. It maintains color and image clarity.



◀ without filter

Sky 1-A



**Warm UV:** This filter combines the benefits of the UV 17 with Tiffen's 812 Color Warming Filter for added warmth. An f-stop compensation of 1/3 is recommended. (Discontinued, the UV 17 filter was created for the technically-minded image maker who wanted to absorb most but not all UV light. It absorbs slightly less UV light than the Haze 2A.

**Sky 1A:** Popular general use filter with a pink tint for added warmth and better colors. Very helpful when shooting in outdoor open shade and on overcast days. The Sky 1A absorbs almost half of UV light. Also available as a multi-coated filter, and in thin ring lens mount for wide angle lenses.

### STANDARD & WIDE ANGLE PROTECTION AND UV FILTERS

| Filter Sizes                 | 49    | 52    | 55    | 58    | 62    | 67    | 72    | 77    | 82    | 86    | 95     | 105    | Series 9* |
|------------------------------|-------|-------|-------|-------|-------|-------|-------|-------|-------|-------|--------|--------|-----------|
| Clear #TIC( )                | 9.95  | 9.95  | 9.95  | 12.50 | 14.95 | 14.95 | 24.95 | 24.95 | 38.95 | 73.95 | 125.95 | 109.95 | 69.95     |
| UV Protector #TIUVP( )       | 9.25  | 9.25  | 9.25  | 11.95 | 15.40 | 15.40 | 29.99 | 29.99 | 47.95 | —     | —      | —      | —         |
| Warm UV #TIWUV( )            | —     | 19.19 | 19.19 | 20.50 | 29.20 | 29.20 | 50.85 | 50.85 | 70.45 | 91.95 | —      | —      | 89.00     |
| Sky 1A #TISL( )              | 9.95  | 9.95  | 9.95  | 12.80 | 16.40 | 16.40 | 29.40 | 29.40 | 44.60 | 79.95 | 146.00 | 146.00 | 102.00    |
| UV Haze -1 #TIUV( )          | 9.95  | 9.95  | 9.95  | 12.80 | 16.40 | 16.40 | 29.40 | 29.40 | 44.60 | 79.95 | 146.00 | 146.00 | 102.00    |
| UV Haze-2A #TIUV2A( )        | 19.19 | 19.19 | 19.19 | 20.50 | 29.20 | 29.20 | 50.85 | 50.85 | 70.45 | 91.95 | 173.95 | 173.95 | 89.95     |
| W/A UV Protector #TIUVP( )WA | —     | —     | —     | 14.95 | 18.65 | 18.65 | 37.65 | 37.65 | —     | —     | —      | —      | —         |
| W/A UV Haze-1 #TIUV( )WA     | —     | —     | —     | 20.85 | 27.30 | 27.30 | 48.99 | 48.99 | —     | —     | —      | —      | —         |
| W/A Sky 1A #TISL( )WA        | —     | —     | —     | 20.85 | 27.30 | 27.30 | 48.99 | 48.99 | —     | —     | —      | —      | —         |

UV Protector is also available for 25mm, 28mm, 30mm, 30.5, 34mm, 37mm, 40.5mm, 43mm and 46mm: #TIC( ) .....9.25

UV-Haze-1 is also available in 37mm, 40.5mm, 43mm and 46mm: #TIUV( ) .....9.25

In the parenthesis insert the filter size. For example, a 49mm UV Haze-2A filter would be TIUV2A49. For Series 9, insert S9.



**ONE HOUR FREE PARKING**  
**AT 349 W. 34th STREET** (with purchase of \$100 or more)

## POLARIZERS

Polarizers are used to increase general outdoor color saturation and contrast. They can darken a blue sky on color as well as on B&W film, but there are several factors to remember when doing this. To deepen a blue sky, it must be blue to start with, not white or hazy. Polarization is also angle-dependent. A blue sky will not be equally affected in all directions. The areas of deepest blue are determined by the following "rule of thumb." When setting up an exterior shot, make a right angle between thumb and forefinger. Point your forefinger at the sun. The area of deepest blue will be the band outlined by your thumb as it rotates around the pointing axis of your forefinger, directing the thumb from horizon to horizon. Generally, as you aim your camera either more into or away from the sun, the effect will gradually diminish. There is no effect directly at or away from the sun. Do not pan with a polarizer, without checking to see that the change in camera angle doesn't create undesirable changes in color or saturation. Also, with an extra-wide-angle view, the area of deepest blue may appear as a distinctly darker band in the sky. Both situations are best avoided. Polarizers need approximately 1/2 to 2-stop exposure compensation, usually without regard to rotational orientation or subject matter. They are also available in combination with certain standard conversion filters, such as the 85BPOL. In this case, add the polarizer's compensation to that of the second filter.



**Standard (Linear) Polarizer:** Polarizers provide color and contrast enhancement. Reflected light often shows up as whitish glare that washes color in an image. A Polarizer corrects this problem producing deep, dramatically blue skies. It also removes glare from non-metallic surfaces, such as windows and water. Color saturation in general, especially outdoors, can be improved significantly.

**Warm Polarizer:** Warm polarizer combines the benefits of the polarizer with the warming effect of the 812 Color Warming filter, making it ideal for portraits and scensics.

**Circular Polarizer:** Beam splitting metering systems in autofocus SLRs employ internal surfaces that themselves polarize light. Using a standard (linear) polarizer will cause the light to be further absorbed by the internal optics, depending on the relative orientation. A Circular Polarizer is a linear one to which has been added, on the side facing the camera, a quarter wave "retarder". "This "corkscrews" the plane of polarization, effectively depolarizing it, eliminating the problem. Otherwise functions the same as a linear polarizer.

**Wide Circular Polarizer:** Also available in thin filter rings designed to avoid vignetting on wide angle lenses

### POLARIZING FILTERS

| Filter Sizes                | 49    | 52    | 55    | 58    | 62    | 67    | 72    | 77    | 82    | 86    | 95     | 105    | Series 9 |
|-----------------------------|-------|-------|-------|-------|-------|-------|-------|-------|-------|-------|--------|--------|----------|
| Linear Polarizer #TIP( )    | 16.59 | 16.59 | 16.59 | 19.74 | 23.95 | 23.95 | 37.40 | 37.40 | 49.35 | 99.95 | 162.95 | —      | 129.95   |
| Warm Polarizer #TIWP( )     | 28.99 | 28.99 | 28.99 | 35.19 | 43.45 | 43.45 | 57.19 | 57.19 | 75.75 | —     | 307.95 | 307.95 | 114.95   |
| Circular Polarizer #TICP( ) | 34.95 | 34.95 | 34.95 | 36.95 | 49.95 | 49.95 | 67.50 | 67.50 | 99.95 | —     | —      | —      | —        |
| W/A Circ. Pola #TICP( )WA   | —     | —     | —     | 54.95 | 65.45 | 65.45 | 79.95 | 79.95 | —     | —     | —      | —      | —        |

Linear Polarizer is also available in 37mm, 43mm and 46mm: #TIP( ) .....16.59

Circular Polarizer is also available for 25mm, 28mm, 30mm, 34mm, 37mm, 40.5mm, 43mm and 46mm: #TICP( ) .....34.95

In the parenthesis insert the filter size. For example, a 55mm Linear Polarizer filter would be TIP55. For Series 9, insert S9.

## COLOR CORRECTION FILTERS

### Light Balancing (81, 82 Series)

The 81 series filters are used in cool light conditions to control the bluish coloration that affects daylight film. They can also remove excessive blue from the effects of electronic flash. Good for general scenics to remove the bluish cast from open shade or just add warmth to the photograph—great for improving flesh tones. As letters advance, density and warmth increases with an 81EF having the greatest effect. Whereas the 81 Series creates a feeling of warmth, the 82 Series creates a feeling of coolness. An 82A increases color temperature slightly for a cooler tone. These light blue filters absorb the excessive yellow-red light from daylight in the morning and evening hours and keeps skin tones close to natural.



without filter



with 81C filter

#### 81 & 82 SERIES LIGHT BALANCING FILTERS

| Filter Sizes                    | 49    | 52    | 55    | 58    | 62    | 67    | 72    | 77    | 82    | 86    | 95     | 105    | Series 9 |
|---------------------------------|-------|-------|-------|-------|-------|-------|-------|-------|-------|-------|--------|--------|----------|
| 81A (3400 to 3200K) #TI81A( )   | 11.25 | 11.25 | 11.25 | 12.49 | 17.39 | 17.39 | 30.80 | 30.80 | 42.19 | 91.95 | 173.95 | 173.50 | 89.00    |
| 81B (3500 to 3200K) #TI81B( )   | 11.25 | 11.25 | 11.25 | 12.49 | 17.39 | 17.39 | 30.80 | 30.80 | 42.19 | 91.95 | 173.95 | 173.50 | 89.00    |
| 81C (3600 to 3200K) #TI81C( )   | 19.19 | 19.19 | 19.19 | 20.50 | 29.20 | 29.20 | 50.85 | 50.85 | 70.45 | 91.95 | 173.95 | 173.95 | —        |
| 81EF (3900 to 3200K) #TI81EF( ) | —     | 19.19 | 19.19 | 20.50 | 29.20 | 29.20 | 50.85 | 50.85 | 70.45 | 91.95 | 173.95 | 173.95 | 89.00    |
| 82A (3000 to 3200K) #TI82A( )   | 19.19 | 19.19 | 19.19 | 20.50 | 29.20 | 29.20 | 50.85 | 50.85 | 70.45 | 91.95 | 173.95 | 173.95 | 89.00    |
| 82B (2900 to 3060K) #TI82B( )   | 19.19 | 19.19 | 19.19 | 20.50 | 29.20 | 29.20 | 50.85 | 50.85 | 70.45 | 91.95 | 173.95 | 173.95 | —        |

In the parenthesis insert the filter size. For example, a 77mm 81C filter would be TI81C77. For Series 9, insert S9.



without filter



with Neutral Density filter

### Light Balancing (Neutral Density)

When you want to maintain a particular lens opening for sharpness or depth-of-field purposes, or simply to obtain proper exposure when confronted with too much light intensity, use a Neutral Density (ND) filter. This will absorb light evenly throughout the visible spectrum, effectively altering exposure without requiring a change in lens opening and without introducing a color shift. For all film types, color or black and white. Neutral Density .3, .6, .9 absorbs 1, 2, and 3 stops, respectively. Provides balanced exposures and depth-of-field control. Eliminates overly bright, washed out images.

A Neutral Density filter reduces the amount of light passing through the camera lens without changing the color of the scene. It is especially useful in bright light conditions to help prevent overexposure. The neutral density filter also allows proper exposure at a wider lens opening for reduce depth-of-field to highlight a key subject by making the foreground and/or background out of focus. The Neutral Density filter also allows shutter speeds to produce blurred motion effects. Available in densities 0.3, 0.6 and 0.9.

#### ND (NEUTRAL DENSITY) FILTERS

| Filter Sizes                  | 49    | 52    | 55    | 58    | 62    | 67    | 72    | 77    | 82    | 86    | 95     | 105    | Series 9 |
|-------------------------------|-------|-------|-------|-------|-------|-------|-------|-------|-------|-------|--------|--------|----------|
| ND 0.3 (1 f-stop) #TIND.3( )  | 11.25 | 11.25 | 11.25 | 12.45 | 17.25 | 17.25 | 30.80 | 30.80 | 42.19 | 91.95 | 173.95 | 173.95 | 89.95    |
| ND 0.6 (2 f-stops) #TIND.6( ) | 11.25 | 11.25 | 11.25 | 12.45 | 17.25 | 17.25 | 30.80 | 30.80 | 42.19 | 91.95 | 173.95 | 173.95 | 89.95    |
| ND 0.9 (3 f-stops) #TIND.9( ) | 11.25 | 11.25 | 11.25 | 12.45 | 17.25 | 17.25 | 30.80 | 30.80 | 42.19 | 91.95 | 173.95 | 173.95 | 89.95    |

In the parenthesis insert the filter size. For example, a 52mm ND 0.9 filter would be TIND.952. For Series 9, insert S9.



## COLOR CORRECTION FILTERS

### Color Conversion Filters (80, 85 Series)

Sunlight, daylight, incandescent, fluorescent, and other artificial light sources all have color characteristics that vary significantly. Filters give you better images by adjusting for these light variations. Film is rated for a particular color temperature such as that of daylight or tungsten light. Filters are used to correct differences in color temperature between the recording medium and the light source. The 80 Series gets you the right colors when shooting indoors under tungsten lighting with daylight film and no flash. The 85 Series is for shooting tungsten corrected film outdoors. Using tungsten film in daylight produces a bluish cast, with the 85 Series you get natural colors. For best results use the filter that accurately matches your film type.

**80A:** Balances daylight film for use with most standard tungsten lighting, studio lighting and copystand lighting.

**80B:** Balances daylight film for use with photo flood lamps.

**85:** Produces slightly cooler results than the 85B

**85B:** Converts Type B film to daylight

**85C:** Used as a creative warming effect with daylight film in daylight. Produces cooler results with tungsten film in daylight than the 85 or 85B



### COLOR CONVERSION FILTERS

| Filter Sizes         | 49    | 52    | 55    | 58    | 62    | 67    | 72    | 77    | 82    | 86    | 95     | 105    | Series 9 |
|----------------------|-------|-------|-------|-------|-------|-------|-------|-------|-------|-------|--------|--------|----------|
| <b>80A</b> #TI80A( ) | 11.25 | 11.25 | 11.25 | 12.49 | 17.39 | 17.39 | 30.80 | 30.80 | 42.19 | 91.95 | 173.95 | 173.95 | 89.00    |
| <b>80B</b> #TI80B( ) | 11.25 | 11.25 | 11.25 | 12.49 | 17.39 | 17.39 | 30.80 | 30.80 | 42.19 | 91.95 | 173.95 | 173.50 | 89.00    |
| <b>85</b> #TI85( )   | 19.19 | 19.19 | 19.19 | 20.50 | 29.20 | 29.20 | 50.85 | 50.85 | 70.45 | 91.95 | 173.95 | 173.95 | 89.00    |
| <b>85B</b> #TI85B( ) | 19.19 | 19.19 | 19.19 | 20.50 | 29.20 | 29.20 | 50.85 | 50.85 | 70.45 | 91.95 | 173.95 | 173.95 | 89.00    |
| <b>85C</b> #TI85C( ) | 19.19 | 19.19 | 19.19 | 20.50 | 29.20 | 29.20 | 50.85 | 50.85 | 70.45 | 91.95 | 173.95 | 173.95 | 89.00    |

### FL-D (Fluorescent) Light Balancing Filter

The FL-D provides correct color and pleasing skin tones by removing harsh green cast caused by fluorescent lighting. Use FL-D with daylight film. Essential in any environment where ambient light source is fluorescent, this filter delivers true-to-life color rendition.

**Sepia:** Creates a warm brown tone (for color imaging) for that old time feeling. Available in three grades with #3 adding a light fog effect.



### Magenta CC30M Color Compensating Filter

Some photographic situations require specific color corrections. For example, when shooting daylight film under fluorescent lighting, some magenta correction is needed in order to remove the greenish tint that would otherwise appear. The Magenta CC30M balances excessive green cast and produce creative effects. Great for early morning tint.

### FL-D, SEPIA & MAGENTA CC30M FILTERS

| Filter Sizes             | 49    | 52    | 55    | 58    | 62    | 67    | 72    | 77    | 82    | 86    | 95     | 105    | Series 9 |
|--------------------------|-------|-------|-------|-------|-------|-------|-------|-------|-------|-------|--------|--------|----------|
| <b>FL-D</b> #TIFLD( )    | 14.50 | 14.50 | 14.50 | 18.15 | 22.70 | 22.70 | 36.48 | 36.48 | 66.00 | 91.95 | 173.95 | 173.95 | 89.95    |
| <b>Sepia 1</b> #TIS1( )  | 28.50 | 28.50 | 28.50 | 34.40 | 43.89 | 43.89 | 57.60 | 57.60 | —     | 79.95 | 173.95 | 173.95 | 93.95    |
| <b>Sepia 2</b> #TIS2( )  | 28.50 | 28.50 | 28.50 | 34.40 | 43.89 | 43.89 | 57.60 | 57.60 | —     | 79.95 | 173.95 | 173.95 | 93.95    |
| <b>Sepia 3</b> #TIS3( )  | 28.50 | 28.50 | 28.50 | 34.40 | 43.89 | 43.89 | 57.60 | 57.60 | —     | 79.95 | 173.95 | 173.95 | 93.95    |
| <b>CC30M</b> #TICC30M( ) | 35.79 | 35.79 | 35.75 | 47.20 | 60.95 | 60.95 | 88.45 | 88.45 | —     | —     | 254.95 | 254.95 | 111.95   |

In the parenthesis insert the filter size. For example, a 72mm FL-D filter would be TIFLD72. For Series 9, insert S9.

## SPECIALTY FILTERS

FILTERS

412

### Warming & Enhancing Filters



without filter



with 812 Warming

A Tiffen exclusive, the 812 Color Warming filter improves skintones and is ideal for portraits taken on a cloudy day or outdoor in shade on a sunny day. Ideal for portraits or scenics, the 812 absorbs blue cast often caused by electronic flash and adds warmth to pale washed-out flesh tones. Use in place of the Sky 1A when warmer results are desired. Tiffen's exclusive Enhancing filter makes reds, rust browns and oranges "POP" with minimal effect on other colors. A combination of rare earth elements in glass, the Enhancing filter completely removes a portion of the spectrum in the orange region. The effect is to increase the color saturation intensity of certain brown, orange, and reddish objects by eliminating the muddy tones and maximizing the crimson and scarlet components. Its most frequent use is for obtaining strongly saturated fall foliage.

Skin tones might be overly warm. Also ideal for earth tone rock formations, architecture, woodwork, and faded rustic barns. Combine with a polarizer filter for more dramatic effects.

#### WARMING & ENHANCING FILTERS

| Filter Sizes                | 49    | 52    | 55    | 58    | 62    | 67    | 72    | 77    | 82    | 86     | 95     | 105    | Series 9 |
|-----------------------------|-------|-------|-------|-------|-------|-------|-------|-------|-------|--------|--------|--------|----------|
| 812 Warming #TI812( )       | 11.25 | 11.25 | 11.25 | 12.50 | 17.39 | 17.39 | 29.95 | 29.95 | 41.95 | 91.95  | 173.95 | 173.95 | 89.00    |
| W/A 812 Warming #TI812( )WA | —     | —     | —     | 24.95 | 34.95 | 34.95 | 62.50 | 62.50 | —     | —      | —      | —      | —        |
| Enhancing #TIE( )           | 44.95 | 44.95 | 44.95 | 66.95 | 69.95 | 69.95 | 75.95 | 75.95 | 83.95 | 119.00 | 349.95 | 399.95 | 126.95   |
| W/A Enhancing #TIE( )WA     | —     | —     | —     | 72.95 | 79.95 | 79.95 | 99.95 | 99.95 | —     | —      | —      | —      | —        |

### Fog Filters

Fog filters mimic the effect of natural fog, creating a soft glow and flare and producing a warm romantic tone. (A natural fog causes lights to glow and flare). Contrast is generally lower, and sharpness may be affected as well. The soft glow can be used to make lighting more visible, make it better felt by the viewer. The effect of humidity in, say, a tropical scene can be created or enhanced. Double Fog filters have milder flare and softening characteristics than standard Fog filters while exhibiting a much greater effect on contrast. A very thick natural fog will still allow close-up objects to appear sharp. So will a Double Fog filter. The key to the effect is the much lower contrast combined with a minimal amount of highlight flare.



without filter



with Fog 3 filter



with Double Fog 3 filter

#### FOG FILTERS

| Filter Sizes           | 49    | 52    | 55    | 58    | 62    | 67    | 72    | 77    | 82 | 86    | 95     | 105    | Series 9 |
|------------------------|-------|-------|-------|-------|-------|-------|-------|-------|----|-------|--------|--------|----------|
| FOG 3 #TIF3( )         | 28.50 | 28.50 | 28.50 | 34.40 | 43.89 | 43.89 | 57.60 | 57.60 | —  | 96.95 | 173.95 | 173.95 | 93.95    |
| Double FOG 3 #TIDF3( ) | —     | 28.50 | 28.50 | 34.40 | 43.89 | 43.89 | 57.60 | 57.60 | —  | 96.95 | 173.50 | 173.50 | 93.95    |

In the parenthesis insert the filter size. For example, a 67mm Fog 3 filter would be TIF367. For Series 9, insert S9.



For Any Inquiries Regarding Your Order, Call Our Customer Service:  
(800) 221-5743 • (212) 239-7765 • FAX: (800) 947-2215 • (212) 239-7549

## SPECIALTY FILTERS

### Star Filters

Generate photographic excitement with these dazzling star effects created from original point light sources or bright reflections. The Star effect will become more pronounced with a brighter, larger source. Filter may be rotated for creative control.

Lighting can be enhanced in ways that go beyond what exists in nature. Star filters create points of light, like “stars”, streaking outward from a central light source. This can make lighting within the scene take on a more glittering, glamorous appearance. This effect is produced by a series of thin lines etched into the flat optical surface of a clear filter. These lines act as cylindrical lenses, diffracting light points into long thin lines of light running perpendicular to the etched lines. Lines on the filter positioned horizontally produce vertically oriented star lines. The size and brightness of the star lines produced are first a function of the size, shape, and brightness of the light source. You have additional control through the choice of a particular spacing between the lines on the filter. Generally these spacings are measured in millimeters.

A 1mm spacing has twice as many lines per unit area as a 2mm spacing. It will produce a brighter star for any given source. Spacings offered generally range from 1mm to 4mm, as well as both narrower and wider for specialty effects.

The number of directions that lines run in determines the number of points produced. Lines in one direction produce a two-pointed star, just a streak through the center of the light. There are 4 and 6 more points available. With an 8-point filter, the many star lines will tend to overpower the rest of the image, so be careful. Although the more common types have a symmetrical arrangement of points, they can also be obtained with asymmetric patterns, which tend to appear more “natural”, less synthetic. For example, the North Star, and Vector Star. They can be used together to create remarkably creative effects.

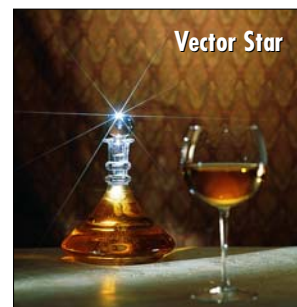
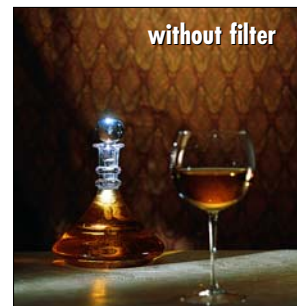

#### STAR FILTERS

| Filter Sizes                     | 49    | 52    | 55    | 58    | 62     | 67     | 72     | 77     | 82 | 86     | 95     | 105    | Series 9 |
|----------------------------------|-------|-------|-------|-------|--------|--------|--------|--------|----|--------|--------|--------|----------|
| Star Effect 4 pt. 2mm #TIS4P2( ) | 19.50 | 19.50 | 19.50 | 23.50 | 36.95  | 36.95  | —      | —      | —  | —      | 209.95 | 209.95 | 152.95   |
| Star Effect 6 pt. 2mm #TIS6P2( ) | 27.20 | 27.20 | 27.20 | 30.60 | 42.60  | 42.60  | 72.00  | 72.00  | —  | —      | 209.95 | 209.95 | 152.95   |
| Star Effect 8 pt. 2mm #TIS8P2( ) | 30.00 | 30.00 | 30.00 | 34.09 | 47.05  | —      | 74.84  | 74.84  | —  | 179.95 | —      | —      | 157.95   |
| North Star #TINS( )              | 66.05 | 66.05 | 66.05 | 73.89 | 103.09 | 103.09 | 111.50 | 111.50 | —  | 173.95 | 209.95 | 209.95 | 209.95   |
| Vector Star #TIVS( )             | 55.25 | 55.25 | 55.25 | 61.89 | 85.89  | 85.89  | 111.75 | 111.75 | —  | —      | —      | 209.95 | 157.95   |

In the parenthesis insert the filter size. For example, an 86mm North Star filter would be TINS86. For Series 9, insert S9.

### Close-up Lens Set (+1, +2, +4)

Do you wish that your lens could focus closer than it does? Close-up lenses work are the simplest and least expensive method of close-up photography. Available in different “powers” (diopters), the +1 lets you focus your lens somewhat closer than it already does, +2 close-up focuses closer than the +1, the +4 lens even closer than that, and so on. They can be used individually or in any combination to achieve ultra-close focus. The maximum magnification achieved will depend on the focal length of your lens as well as the actual close focusing capability of that particular lens. (Note: +1 with a +2 equals +3, while a +2 combined with a +4 equals +6, and so on.)

### 87 Infrared Filter

This filter is for black and white infrared film when you only want to transmit the infrared spectrum and none of the visible spectrum. Filter factor is determined by the film sensitivity.

#### CLOSE-UP LENSES & INFRARED FILTERS

| Filter Sizes                | 49    | 52    | 55    | 58    | 62     | 67     | 72     | 77     | 82 | 86 | 95 | 105 | Series 9 |
|-----------------------------|-------|-------|-------|-------|--------|--------|--------|--------|----|----|----|-----|----------|
| Close-Up Lens Set #TICUS( ) | 36.00 | 36.00 | 36.00 | 45.90 | 58.95  | 58.95  | 84.15  | 84.15  | —  | —  | —  | —   | —        |
| 87 Infrared #TI87( )        | 86.05 | 86.05 | 86.05 | 89.09 | 107.35 | 107.35 | 128.84 | 128.84 | —  | —  | —  | —   | —        |

In the parenthesis insert the filter size. For example, a 49mm 87 Infrared filter would be TI8749. For Series 9, insert S9.



## HOLLYWOOD/FX FILTERS

FILTERS

414

### Pro-Mist & Warm Pro-Mist

The Pro-Mist filter is exceptional for diffusing or softening images, whether to create a mood in a landscape or portrait or simply as an aid to make people look glamorous. Indoors or out, in broad scenics or portraits, the Pro-Mist tones down excessive sharpness and reduces contrast by moderately lightening shadow areas without detracting from the overall image. This is especially useful given the contrast and extremely sharp resolution produced by today's films and lenses. Pro-Mist filters also yield moderate flare that appears to stay close to the light source like a halo, creating an almost pearlescent glow around highlights. The filters are also used to mute colors and create exquisite pastel tones.

The Warm Pro-Mist combines the benefits of the widely acclaimed Pro-Mist with the Tiffen exclusive 812 color warming filter, adding a natural warmth to skin tones, exterior shade and highlight areas. This is useful in outdoor open shade situations where there is excessive blue in the image and when total control over lighting may not be possible. The Warm Pro-Mist eliminates pale, washed out skintones and can help balance contrasting skintones within one scene. Neutral colors remain unaffected.

without filter

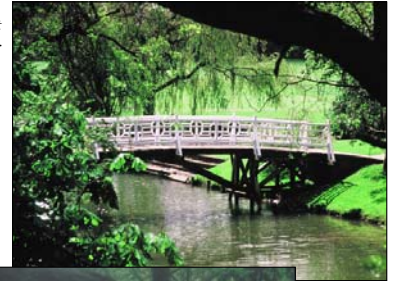

with Pro Mist 3 filter

### PRO MIST FILTERS

| Filter Sizes                       | 49    | 52    | 55    | 58    | 62    | 67    | 72    | 77    | 82    | 86     | 95     | 105    | Series 9 |
|------------------------------------|-------|-------|-------|-------|-------|-------|-------|-------|-------|--------|--------|--------|----------|
| Pro-Mist #TIPM( ) ( )              | 37.95 | 37.95 | 37.95 | 43.50 | 54.50 | 54.50 | 71.50 | 71.50 | 89.95 | 110.45 | 209.95 | 209.95 | 107.95   |
| Warm Pro-Mist #TIWPM( ) ( )        | 39.99 | 39.99 | 39.99 | 43.89 | 54.95 | 54.95 | 72.29 | 72.29 | 89.95 | 110.45 | 209.95 | 209.95 | 107.95   |
| Black Pro-Mist #TIBPM( ) ( )       | 37.95 | 37.95 | 37.95 | 43.50 | 54.50 | 54.50 | 71.50 | 71.50 | 89.95 | 110.45 | 209.95 | 209.95 | 107.95   |
| Warm Black Pro-Mist #TIWBPM( ) ( ) | 39.99 | 39.99 | 39.99 | 43.89 | 54.95 | 54.95 | 72.29 | 72.29 | 89.95 | 110.45 | 209.95 | 209.95 | 107.95   |

The Pro-Mist, Warm Pro-Mist, Black Pro-Mist and Warm Black Pro-Mist are available in densities 1/2, 1, 2 and 3. The higher the density, the greater effect of diffusion. The warm color remains constant in all densities while the amount of softening varies. Please insert the density # in the first parenthesis (.5, 1, 2, 3, 5) and the filter size (49, 52, 55 etc.) in the second parenthesis. For Series 9, insert S9.

### Black Pro-Mist & Warm Black Pro-Mist

The Black Pro-Mist offers all of the benefits of the Pro-Mist filter in a more subtle form. This filter is excellent for toning down excessive sharpness and reducing contrast by moderately lightening shadow areas. This is especially useful given the contrast and extremely sharp resolution produced by contemporary films and lenses. Pro-Mist filters also yield moderate highlight flare that appears to stay close to the light source like a halo, creating an almost pearlescent glow around the highlights. The Black Pro-Mist creates a definely visible, light "pasteling" effect. The effect is subtle and delicate, with contained highlight flare, less lightening of shadows and moderate reduction of contrast.

The Warm Black Pro-Mist filter offers the dramatic benefits of the Black Pro-Mist and Tiffen's 812 filter for warming skintones, as well as exterior shade and highlight areas. The warming feature also can reduce bluish reflections from dark skintones. The Warm Black Pro-Mist is the right choice when you want to convey a warm, romantic feeling. It is also very useful in outdoor open shade where there is excessive blue, and control over light may not be possible. The Warm Black Pro-Mist helps eliminate the blue cast for a more pleasing effect.

without filter



with Black Pro Mist 3 filter



**ONE HOUR FREE PARKING**  
AT 349 W. 34th STREET (with purchase of \$100 or more)

## HOLLYWOOD/FX FILTERS

### Black and Gold Diffusion/FX Filters

People always want to look good. And they want to look even better in pictures. Here are two ways to get silky-smooth textures, even in tight close-ups without sacrificing image clarity. The Black Diffusion/FX and Gold Diffusion/FX filters use a unique optical construction that produces the most advanced diffuser ever developed by Tiffen. They create a diffused image that doesn't look like it's been shot through a filter.



**Black Diffusion/FX:** This filter gives a silky-smooth look to textured surfaces, so it does a spectacular job of suppressing facial blemishes and wrinkles, while maintaining a clear, focused image. The young woman's eyes and the jewelry on her wrist stay crystal clear, while her face loses the "edginess" of the unfiltered shot. The effect is flattering, by virtually eliminating unwanted details, but without being dull or "fuzzy". At the same time, a bare minimum of highlight flare is produced. The effect of the lighter grades is subtle, with the higher grades becoming gradually more noticeable, all capable of providing a beautiful image.

**Gold Diffusion/FX:** This filter takes the effect of the Black Diffusion/FX a step further. It adds a soft, golden tint to shadows, and infuses images with a special warmth. Yet it still manages to balance any mix of skintones. Neutral colors appear minimally affected, while cool colors and skintones are slightly warmed and softened with beautiful results. The veiled woman takes on a more mysterious, yet inviting, air. At the same time, her eyes and the intricate design of the veil stay clear and sharp. As grades increase, so does the diffusion, but the warm, golden tint stays constant.

### DIFFUSION/FX & SOFT/FX FILTERS

| Filter Sizes                      | 49    | 52    | 55    | 58    | 62    | 67    | 72    | 77    | 82    | 86     | 95     | 105    | Series 9 |
|-----------------------------------|-------|-------|-------|-------|-------|-------|-------|-------|-------|--------|--------|--------|----------|
| Gold Diffusion/FX #TIGDFX( ) ( )  | 39.99 | 39.99 | 39.99 | 43.79 | 54.79 | 54.79 | 72.15 | 72.15 | 94.99 | 123.95 | 254.95 | 254.95 | 119.95   |
| Black Diffusion/FX #TIBDFX( ) ( ) | 30.50 | 30.50 | 30.50 | 39.20 | 48.50 | 48.50 | 65.69 | 65.69 | 94.99 | 123.95 | 254.95 | 254.95 | 119.95   |
| Soft/FX #TISFX( ) ( )             | 30.95 | 30.95 | 30.95 | 39.30 | 48.60 | 48.60 | 65.80 | 65.80 | 95.20 | 110.45 | 209.95 | 209.95 | 107.50   |
| Warm Soft/FX #TIWSFX( ) ( )       | 32.05 | 32.05 | 32.05 | 39.25 | 48.50 | 48.50 | 65.70 | 65.70 | 94.99 | 110.45 | 209.95 | 209.95 | 107.95   |

The Black and Gold Diffusion/FX filters are available in densities 1/2, 1, 3 and 5. The Soft/FX and Warm Soft/FX filters in densities 1/2, 1, 2, 3 and 5. Please insert the density # in the first parenthesis (.5, 1, 2, 3, 5) and the filter size (49, 52, 55 etc.) in the second parenthesis. For example, a 55mm Gold Diffusion filter with a density of 1 would be written TIGDFX155. For Series 9, insert S9.

with Soft/FX

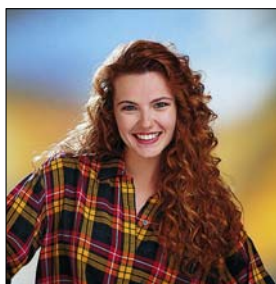

without filter

with Warm Soft/FX



### Soft/FX & Warm Soft/FX Filters

Many techniques have been developed for diffusing or softening images. The Soft/FX filter series alone provides a much sought after effect. It retains overall image clarity while it softens unwanted details. It has a pattern of tiny "lenslets" designed to put fine image elements, like wrinkles and skin blemishes, out of focus while leaving larger details such as eyes, sharp. The proportion of clear space to the diffused pattern on the glass determines the strength of the filter and enables the overall image quality and sharpness to be retained. Lighter densities are very subtle, producing no flare from highlights or reduction in contrast. Higher densities tend to be more noticeable in their effect while still providing a pleasing portrait.

The Warm Soft/FX combines the innovative diffusion technology of the Soft/FX filters with Tiffen's 812 warming filter, balancing contrasting skintones to make people look their best. Ideal for all types of people photography, the Warm Soft/FX can be helpful when a scene involves several people with varying skintones. It provides the dual benefit of softening and warming, while conveniently allowing the use of two filter effects in one position. Neutral colors show little change while cool and skintones are made warmer as well as being softened for a beautiful effect — unmatched anywhere. The higher the density, the greater effect of diffusion. The warm color remains constant in all densities while the amount of softening varies.



## HOLLYWOOD/FX FILTERS

### Ultra Contrast

Controlling the contrast of your film image is critical. Bright lights or sunlight create problems when the ration between the highlight and shadow areas is beyond the latitude of the recording medium. If you expose for the highlights the shadows appear without detail. If you expose for the shadows, the result is washed-out overly bright highlights. Tiffen offers a solution to your contrast problems: The Ultra Contrast filter works with ambient light from surrounding, lowering contrast uniformly through the scene. Shadow areas reveal more detail without any flare or halation from light sources or bright reflections, even direct shooting into the sun.



### ULTRA CONTRAST, CENTER SPOT & COLOR GRAD FILTERS

| Filter Sizes                     | 49    | 52    | 55    | 58    | 62    | 67    | 72    | 77    | 82    | 86     | 95     | 105    | Series 9 |
|----------------------------------|-------|-------|-------|-------|-------|-------|-------|-------|-------|--------|--------|--------|----------|
| Ultra Contrast #TIUC( ) ( )      | 38.50 | 38.50 | 38.50 | 43.50 | 54.95 | 54.95 | 71.95 | 71.95 | 90.45 | 148.95 | 208.95 | 208.95 | CALL     |
| Center Spot #TICS( )             | 23.09 | 23.09 | 23.09 | 25.89 | 29.50 | 29.50 | 38.50 | 38.50 | —     | —      | —      | —      | —        |
| Color Grad Blue #TIGBL( ) ( )    | 32.09 | 32.09 | 32.09 | 35.95 | 42.50 | 42.50 | 57.60 | 57.60 | —     | 153.50 | —      | —      | —        |
| Color Grad ND 0.6 #TIGND.6( )    | 32.09 | 32.09 | 32.09 | 35.95 | 42.50 | 42.50 | 57.60 | 57.60 | —     | 153.50 | —      | —      | 109.95   |
| Color Grad Sunrise #TIGSR( ) ( ) | 32.09 | 32.09 | 32.09 | 35.95 | 42.50 | 42.50 | 57.60 | 57.60 | —     | —      | —      | —      | —        |

The Ultra Contrast filters are available in densities 1, 3 and 5. Please insert the density # in the first parenthesis (.5, 1, 2, 3, 5) and the filter size (49, 52, 55 etc.) in the second parenthesis. For example, an 55mm Ultra Contrast filter with a density of 3 would be written TIUC355. For Series 9, insert S9.

### Center Spot

The Center Spot filter has a clear central area for dramatic focus, surrounded by ring of moderate diffusion to minimize distracting background detail. Which means the Center Spot filter isolates the main subject, held sharp in the clear center, while diffusing a distracting background. With the Center Spot filter, the size of the clear part in the center of the picture varies depending on the focal length and the aperture of the lens used.



### Color Grad Filters

No other filter has done as much to improve landscape photography as the graduated filter. Half color, half clear with a graduated density transition for a smooth blending of color, Tiffen Color Grad filters enable you to add color to a selected part of the scene (with color imaging). One of the most widely used category of filters in the industry today, Color-Grad filters are the perfect solution to transform an average sunrise or sunset into something spectacular or convert a dull, washed-out sky to a breathtaking blue.



Color Grad Blue



Color Grad ND.6



Color Grad Sunrise

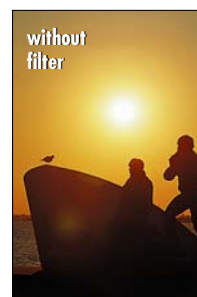

For Any Inquiries Regarding Your Order, Call Our Customer Service:  
 (800) 221-5743 • (212) 239-7765 • FAX: (800) 947-2215 • (212) 239-7549

## GLIMMERGLASS

### The First Filter Series with a “Psychological Edge”

The introduction of the Glimmerglass filter, a new series of Diffusion filters, seems to support the theory that when you “look good, you feel good”. People always want to look their best. And they want to look even better in pictures. Here’s another way Tiffen makes that happen. The Glimmerglass is the first series of filters with a “psychological edge”. A new type of filter, the Glimmerglass softens fine details in a unique manner, while adding a mild glow to highlights. As contrast is also reduced, the look is one of enhanced beauty. A first in this field is the fact that the filter is both effective to look at as well as to look through. The glass itself has a distinct silver ‘sparkle’, which has been found to be doubly useful. When production starts and people see the filter glittering on the front of the lens, they become more confident in the knowledge that the filter is working for them and they may also turn in a better performance.

Glimmerglass filters are available in grades 1-5 in 49mm to 82mm screw-in sizes. The effect of the lighter grades is subtle, with the higher grades becoming gradually more noticeable, all capable of providing a beautiful image.



without filter



without Glimmerglass 5



without Glimmerglass 1

### GLIMMERGLASS AND SMOUQUE FILTERS

| Filter Sizes              | 49    | 52    | 55    | 58    | 62    | 67    | 72    | 77    | 82    |
|---------------------------|-------|-------|-------|-------|-------|-------|-------|-------|-------|
| Glimmerglass #TIGG( ) ( ) | 40.00 | 40.00 | 40.00 | 43.89 | 54.95 | 54.95 | 72.32 | 72.32 | 95.21 |
| Smoque #TIS( ) ( ) Q      | 40.00 | 40.00 | 40.00 | 43.89 | 54.95 | 54.95 | 72.32 | 72.32 | 95.21 |

Glimmerglass filters are available in densities 1, 2, 3, 4 and 5. Smoque filters in densities 1, 2, 3 and 4. Please insert the density # in the first parenthesis (1, 2, 3, 4, 5) and the filter size (49, 52, 55 etc.) in the second parenthesis. For example, an 67mm Glimmerglass filter with a density of 3 would be written TIGG367.



without filter



with Smoque 4

## SMOQUE

### Create the Look of Smoke Without the Hassle

The Smoque filter produces a smoke-like effect without the cost and hassle of a generator or the smoke it produces. Mechanical smoke generators are often used to add atmospheric haze to a scene. This could be for enhanced realism in places where smoke is normally encountered, like a nightclub, or the scene of a fire. Most often, the smoke is added to create a certain “look”. The difficulty and cost of using this equipment and the fact that it is less desirable to work in a smoke-filled environment make the Smoque filters really valuable as a way to get a similar look without the need for the generator or the smoke it produces. Available in 4 grades, the Smoque filters can be used to create the look alone, or in addition to a more modest application of real smoke. They allow greater base level consistency especially outdoors in a wind, and you don’t have to wait for it to settle or to be replenished, as with real smoke. The effect of the lighter grades is subtle, with the higher grades becoming gradually more noticeable, all capable of providing a beautiful image.

## B&W FILTERS

Although originally intended for use with black and white film, these filters can also be used as a creative tool in color photography. Black and white imaging records only tonal differences between colored objects, which appear as black, white, or different shades of gray. Proper rendition depends on your own desires, and, for film, the differences between film sensitivity to colors and that of the eye. The latter is due to the fact that most panchromatic emulsions used are more sensitive to blue, violet and ultraviolet than to other colors. Therefore, blue appears as lighter on film than it does to the eye. This can make a blue sky light enough to appear a similar shade of light gray as the clouds that are in it, making the clouds "disappear." A more "correct" cloud presence is obtained through the use of a Yellow #8, which can absorb blue light, darkening the sky to more closely match what the eye would see. The #8 also acts as a general compensator for most subjects, giving a tonal rendition similar to that of the eye. Deeper colors, further to the red end of the spectrum, such as Deep Yellow #15, Orange #16, and Red #25 and #29 filters will produce progressively deeper and artificially more dramatic renditions of blue sky.

Remember that, since these filters act on color differences to produce tonal differences, the required colors must be present. The part of the sky you are recording must be blue to be affected. Sky sections closer to the sun, or nearer the horizon, are generally less blue than elsewhere. Use of a graduated neutral density filter can darken a sky relative to the foreground, but will not increase contrast between a blue sky and the clouds.

Using filters for contrast control can be a matter of artistic preference, or of necessity. It is possible for two disparate colors, say a certain orange and blue, to record as the identical tone, eliminating any visible difference between them. Filters will lighten objects of their own color and darken those of their complement. Complementary color pairs are: green-red; orange-blue; violet-yellow. An orange filter in the above case will darken the blue, and lighten the orange; a blue filter will perform the reverse. A green filter, such as #11, can be used to lighten green foliage, to show more detail. It may also be used to provide more pleasing skin tones outdoors, especially against blue sky.

Any filter used for the above purposes will have a greater effect if slightly underexposed. Its function depends on absorbing light of its complementary colors to increase the proportion of light of colors similar to itself. Exposure compensation is often needed to allow proper image density, but the relative difference is reduced by the addition of light at the absorbed wavelengths through additional exposure.

Other filters include Yellow 12 which cuts haze in aerial work and reduces excess blue of full moon in astrophotography; Orange 21 absorbs blue and blue greens, renders blue tones darker as in marine scenes; Green 58 is a dark green filter that produces very light foliage; Red 23A is a light red filter producing contrast effects that darken the sky and water; Blue 47 is a dark blue filter that accentuates haze and fog, used for dye transfer and contrast effects; Blue 47B is a dark blue filter that lightens blue objects for detail.



without filter



with Yellow #15

### B&W FILTERS

| Filter Sizes             | 49    | 52    | 55    | 58    | 62    | 67    | 72    | 77    | 82    | 86    | 95     | 105    | Series 9 |
|--------------------------|-------|-------|-------|-------|-------|-------|-------|-------|-------|-------|--------|--------|----------|
| Blue #47 #TI47( )        | 19.19 | 19.19 | 19.19 | 20.50 | 29.20 | 29.20 | 50.85 | 50.85 | 70.45 | 91.95 | 173.95 | 173.95 | 89.00    |
| Yellow 2 #8 #TI8( )      | 11.25 | 11.25 | 11.25 | 12.49 | 17.39 | 17.39 | 30.80 | 30.80 | 42.19 | 91.95 | 173.95 | 173.95 | 89.00    |
| Yellow #12 #TI12( )      | 19.19 | 19.19 | 19.19 | 20.58 | 29.20 | 29.20 | 50.85 | 50.85 | 70.45 | 91.95 | 173.95 | 173.95 | 89.00    |
| Deep Yellow #15 #TI15( ) | 11.25 | 11.25 | 11.25 | 12.49 | 17.39 | 17.39 | 30.80 | 30.80 | 42.19 | 91.95 | 173.95 | 173.95 | 89.00    |
| Green 1 #11 #TI11( )     | 11.25 | 11.25 | 11.25 | 12.49 | 17.39 | 17.39 | 30.80 | 30.80 | 42.19 | 91.95 | 173.50 | 173.95 | 89.00    |
| Green #58 #TI58( )       | 19.19 | 19.19 | 19.19 | 20.50 | 29.20 | 29.20 | 50.85 | 50.85 | —     | 91.95 | 173.50 | 173.95 | 89.00    |
| Orange #16 #TI16( )      | 19.19 | 19.19 | 19.19 | 20.50 | 29.20 | 29.20 | 50.85 | 50.85 | 70.45 | 91.95 | 173.50 | 173.50 | 89.00    |
| Orange #21 #TI21( )      | 19.19 | 19.19 | 19.19 | 20.50 | 29.20 | 29.20 | 50.85 | 50.85 | 70.45 | 91.95 | 173.95 | 173.95 | 89.00    |
| Light Red #23A #TI23A( ) | 19.19 | 19.19 | 19.19 | 20.50 | 29.20 | 29.20 | 50.85 | 50.85 | —     | 91.95 | 173.95 | 173.95 | 89.00    |
| Red 1 #25 #TI25( )       | 11.25 | 11.25 | 11.25 | 12.49 | 17.39 | 17.39 | 30.80 | 30.80 | 42.19 | 91.95 | 173.95 | 173.95 | 89.00    |
| Dark Red #29 #TI29( )    | 19.19 | 19.19 | 19.19 | 20.50 | 29.20 | 29.20 | 50.85 | 50.85 | 70.45 | 91.95 | 173.95 | 173.95 | 89.00    |

*In the parenthesis insert the filter size. For example, a 62mm Deep Yellow #15 would be TI1562. For Series 9, insert S9.*



**EQUIPMENT LEASING AVAILABLE**

## FILTER KITS

*More economical than individual filter purchases, these multiple filter kits take the guesswork out of having a variety of creative filter effects at your fingertips. Pre-packaged assortments, with combinations of Tiffen's most popular filters, provide a range of artistic possibilities for almost every photographic application and budget.*



**Photo Twin Pack:** Includes UV Protection Filter to protect your camera lens against dust, dirt, fingerprints and other damage; and Circular Polarizer to produce deep, dramatic blue skies and remove glare from non-metallic surfaces, such as windows and water.

**Photo Essentials Kit:** The ideal kit for portraits and scenics. Includes UV Protector, Circular Polarizer and an 812 Color Warming filter to add warmth to pale flesh tones. Ideal for portraits taken on a cloudy day or outdoors in shade on a sunny day. It absorbs the blue cast often caused by electronic flash. Comes with a 4-pocket pouch.

**Deluxe Enhancing Kit:** The ideal kit for portraits and scenics. Includes UV Protector, Circular Polarizer, 812 Color Warming and Enhancing filter that makes reds, rust browns and oranges "pop" with minimal effect on other colors. Ideal for fall foliage, earthtone rock formations, architecture, woodwork, faded rustic barns and more. Comes with a 4-pocket pouch.

**Wide Angle Filter Kit:** The filters in this kit have a thin ring designed to avoid vignetting in wide-angle lenses. Includes UV Protector, Circular Polarizer and Enhancing filter that makes reds, rust browns and oranges "pop" with minimal effect on other colors. Comes with a 4-pocket pouch.

**Black and White #3 Filter Kit:** Black & white filtration can maintain a proper brightness relationship between colors. To lighten an object, choose a filter the same color as the object. To darken an object, choose a color that absorbs the color of the subject. Includes Red 25, Yellow 6 and Green 13 filters and soft pouch.

**Hollywood/FX Classic Filter Kit:** Unleash your creative talents with this portrait and scenic kit. Includes Warm Soft/FX 3 to warm and soften details while maintaining overall image clarity; Vector Star which creates exciting and dazzling star effects; Black Pro Mist 3 which creates a special "atmosphere" by subtly softening excess sharpness and contrast for a delicate effect; Ultra Contrast 3 which works with surrounding ambient light to capture details lost in shadows, and a 4-pocket pouch to hold them.



**Wedding & Portrait Kit:** If portraits are your specialty, create that special moment with the combination of portrait filters for that special occasion. In addition to the Warm Soft/FX 3 and the Black Pro Mist 3, the kit also includes a Warm Pro Mist 3 to create that special "dreamy" atmosphere by generating a pearlescent halo around highlights. Comes with a 4-pocket pouch.

### FILTER KITS

| Filter Sizes                          | 37    | 43    | 46    | 49     | 52     | 55     | 58     | 62     | 67     | 72     | 77     | 82     |
|---------------------------------------|-------|-------|-------|--------|--------|--------|--------|--------|--------|--------|--------|--------|
| Photo Twin Pack #TIPTP( )             | 36.95 | —     | 36.95 | 36.95  | 36.95  | 36.95  | 36.95  | 54.95  | 54.95  | 79.95  | 79.95  | —      |
| Hollywood FX Classic #TIHWFXCK( )     | —     | —     | —     | 132.95 | 132.95 | 132.95 | 152.95 | 194.95 | 194.95 | 259.95 | 259.95 | 299.95 |
| Wide Angle Kit #TIFK( )WA             | —     | —     | —     | —      | —      | —      | 117.95 | 134.95 | 134.95 | 174.95 | 174.95 | —      |
| Wedding and Portrait Kit #TIWPK( )    | —     | —     | —     | 89.95  | 89.95  | 89.95  | 104.95 | 128.95 | 128.95 | 169.95 | 169.95 | 209.95 |
| Deluxe Enhancing Kit #TIDEK( )        | 79.95 | 79.95 | 79.95 | 79.95  | 79.95  | 79.95  | 104.95 | 122.95 | 122.95 | 163.95 | 163.95 | 209.95 |
| Photo Essentials Kit #TIHK( )         | 44.95 | 44.95 | 44.95 | 44.95  | 44.95  | 44.95  | 44.95  | 68.95  | 68.95  | 102.95 | 102.95 | 154.95 |
| Black & White #3 Filter Kit #TIBWK( ) | —     | —     | —     | —      | 28.95  | —      | 30.95  | 42.95  | —      | 74.95  | —      | —      |

*In the parenthesis insert the filter size. For example, a 49mm Wide Angle Kit would be TIFK49WA.*



# FILTER ACCESSORIES

## STEPPING RINGS

### Step-Up Rings

Ultra-thin step-up rings change the size of front of camera/lens threads. One size accessory can be used on different size lenses. First size shown screws into your lens, the next size is what your new accessory size is now. Step-up rings can also be combined for a new accessory size.

Ultra-thin step-down rings change the size of front of camera/lens threads. One size accessory can be used on different size lenses. When using step-down rings on wide angle lenses, it isn't advised to use much smaller accessories than the lens being used because of the possibility of vignetting. First size is the lens thread, following size is the filter thread.



|                                  |      |                              |      |  |       |
|----------------------------------|------|------------------------------|------|--|-------|
| 25.5 to 37mm: (GBSUR25.537)..... | 6.95 | 46 to 48mm: (GBSUR4648)..... | 5.95 | 58 to 77mm: (GBSUR5877).....             | 6.95  |
| 25.5 to 46mm: (GBSUR25.546)..... | 6.95 | 46 to 49mm: (GBSUR4649)..... | 5.95 | 60 to 62mm: (GBSUR6062).....             | 9.95  |
| 27 to 37mm: (GBSUR2737).....     | 6.95 | 46 to 52mm: (GBSUR4652)..... | 5.95 | 60 to 67mm: (GBSUR6067).....             | 9.95  |
| 27 to 46mm: (GBSUR2746).....     | 6.95 | 46 to 55mm: (GBSUR4655)..... | 5.95 | 62 to 67mm: (GBSUR6267).....             | 6.95  |
| 28 to 37mm: (GBSUR2837).....     | 6.95 | 46 to 58mm: (GBSUR4658)..... | 5.95 | 62 to 72mm: (GBSUR6272).....             | 6.95  |
| 30 to 37mm: (GBSUR3037).....     | 6.95 | 48 to 49mm: (GBSUR4849)..... | 5.95 | 62 to 77mm: (GBSUR6277).....             | 6.95  |
| 30.5 to 37mm: (GBSUR30.537)..... | 6.95 | 48 to 52mm: (GBSUR4852)..... | 5.95 | 62 to 82mm: (GBSUR6282).....             | 9.95  |
| 30.5 to 46mm: (GBSUR30.546)..... | 6.95 | 48 to 55mm: (GBSUR4855)..... | 5.95 | 67 to 72mm: (GBSUR6772).....             | 6.95  |
| 32.5 to 37mm: (GBSUR32.537)..... | 6.95 | 48 to 58mm: (GBSUR4858)..... | 5.95 | 67 to 77mm: (GBSUR6777).....             | 6.95  |
| 34 to 37mm: (GBSUR3437).....     | 6.95 | 49 to 52mm: (GBSUR4952)..... | 5.95 | 67 to 82mm: (GBSUR6782).....             | 9.95  |
| 34 to 46mm: (GBSUR3446).....     | 6.95 | 49 to 55mm: (GBSUR4955)..... | 5.95 | 67 to 95mm: (GBSUR6795).....             | 19.95 |
| 36 to 37mm: (GBSUR3637).....     | 6.95 | 49 to 58mm: (GBSUR4958)..... | 5.95 | 67 to 105mm: (GBSUR67105).....           | 19.95 |
| 36 to 46mm: (GBSUR3646).....     | 6.95 | 49 to 62mm: (GBSUR4962)..... | 6.95 | 72 to 77mm: (GBSUR7277).....             | 6.95  |
| 37 to 37mm: (GBSUR3737).....     | 6.95 | 49 to 67mm: (GBSUR4967)..... | 6.95 | 72 to 82mm: (GBSUR7282).....             | 9.95  |
| 37 to 43mm: (GBSUR3743).....     | 6.95 | 49 to 72mm: (GBSUR4972)..... | 6.95 | 72 to 95mm: (GBSUR7295).....             | 19.95 |
| 37 to 46mm: (GBSUR3746).....     | 6.95 | 49 to 77mm: (GBSUR4977)..... | 6.95 | 72 to 105mm: (GBSUR72105).....           | 19.95 |
| 37.5 to 46mm: (GBSUR37.546)..... | 6.95 | 52 to 55mm: (GBSUR5255)..... | 5.95 | 77 to 82mm: (GBSUR7782).....             | 9.95  |
| 37 to 49mm: (GBSUR3749).....     | 6.95 | 52 to 58mm: (GBSUR5258)..... | 5.95 | 77 to 95mm: (GBSUR7795).....             | 19.95 |
| 37 to 52mm: (GBSUR3752).....     | 6.95 | 52 to 62mm: (GBSUR5262)..... | 6.95 | 77 to 105mm: (GBSUR77105).....           | 19.95 |
| 37 to 58mm: (GBSUR3758).....     | 6.95 | 52 to 67mm: (GBSUR5267)..... | 6.95 | 82 to 95mm: (GBSUR8295).....             | 19.95 |
| 39 to 46mm: (GBSUR3946).....     | 6.95 | 52 to 72mm: (GBSUR5272)..... | 6.95 | 82 to 105mm: (GBSUR82105).....           | 19.95 |
| 39 to 49mm: (GBSUR3949).....     | 6.95 | 52 to 77mm: (GBSUR5277)..... | 6.95 | 86 to 95mm: (GBSUR8695).....             | 19.95 |
| 40.5 to 46mm: (GBSUR40.546)..... | 6.95 | 54 to 55mm: (GBSUR5455)..... | 9.95 | 86 to 105mm: (GBSUR86105).....           | 19.95 |
| 40.5 to 49mm: (GBSUR40.549)..... | 6.95 | 55 to 58mm: (GBSUR5558)..... | 5.95 | 95 to 105mm: (GBSUR95105).....           | 19.95 |
| 43 to 46mm: (GBSUR4346).....     | 6.95 | 55 to 62mm: (GBSUR5562)..... | 6.95 | Bayonet 50 to 55mm: (GBSURB5055).....    | 15.95 |
| 43 to 48mm: (GBSUR4348).....     | 6.95 | 55 to 67mm: (GBSUR5567)..... | 6.95 | Bayonet 50 to 58mm: (GBSURB5058).....    | 15.95 |
| 43 to 49mm: (GBSUR4349).....     | 6.95 | 55 to 72mm: (GBSUR5572)..... | 6.95 | Bayonet 50 to 62mm: (GBSURB5062).....    | 15.95 |
| 43 to 52mm: (GBSUR4352).....     | 6.95 | 55 to 77mm: (GBSUR5577)..... | 6.95 | Bayonet 50 to Bay 60: (GBSURB50B60)..... | 39.95 |
| 43 to 55mm: (GBSUR4355).....     | 6.95 | 58 to 60mm: (GBSUR5860)..... | 9.95 | Bayonet 6 to 67mm: (GBSURB667).....      | 39.95 |
| 43.5 to 46mm: (GBSUR43.546)..... | 6.95 | 58 to 62mm: (GBSUR5862)..... | 6.95 | Bayonet 6 to 72mm: (GBSURB672).....      | 39.95 |
| 43.5 to 48mm: (GBSUR43.548)..... | 6.95 | 58 to 67mm: (GBSUR5867)..... | 6.95 | Bayonet 6 to 77mm: (GBSURB677).....      | 39.95 |
| 44 to 55mm: (GBSUR4455).....     | 9.95 | 58 to 72mm: (GBSUR5872)..... | 6.95 | Bayonet 60 to 67mm: (GBSURB6067).....    | 15.95 |
| 46 to 46mm: (GBSUR4646).....     | 5.95 |                              |      | Bayonet 60 to 77mm: (GBSURB6077).....    | 24.95 |

# FILTER ACCESSORIES

## STEPPING RINGS

### Step-Down Rings

|                                   |       |
|-----------------------------------|-------|
| 40.5 to 37mm: (GBSDR40.537) ..... | 6.95  |
| 43 to 37mm: (GBSDR4337) .....     | 6.95  |
| 43.5 to 37mm: (GBSDR43.537) ..... | 6.95  |
| 46 to 37mm: (GBSDR4637) .....     | 6.95  |
| 46 to 40.5mm: (GBSDR4640.5) ..... | 6.95  |
| 46 to 43mm: (GBSDR4643) .....     | 6.95  |
| 46 to 43.5mm: (GBSDR4643.5) ..... | 6.95  |
| 48 to 40.5mm: (GBSDR4840.5) ..... | 6.95  |
| 48 to 43mm: (GBSDR4843) .....     | 6.95  |
| 48 to 43.5mm: (GBSDR4843.5) ..... | 6.95  |
| 48 to 46mm: (GBSDR4846) .....     | 6.95  |
| 49 to 37mm: (GBSDR4937) .....     | 6.95  |
| 49 to 46mm: (GBSDR4946) .....     | 6.95  |
| 49 to 48mm: (GBSDR4948) .....     | 6.95  |
| 52 to 46mm: (GBSDR5246) .....     | 6.95  |
| 52 to 48mm: (GBSDR5248) .....     | 6.95  |
| 52 to 49mm: (GBSDR5249) .....     | 6.95  |
| 55 to 46mm: (GBSDR5546) .....     | 6.95  |
| 55 to 48mm: (GBSDR5548) .....     | 6.95  |
| 55 to 49mm: (GBSDR5549) .....     | 6.95  |
| 55 to 52mm: (GBSDR5552) .....     | 6.95  |
| 58 to 46mm: (GBSDR5846) .....     | 6.95  |
| 58 to 48mm: (GBSDR5848) .....     | 6.95  |
| 58 to 49mm: (GBSDR5846) .....     | 6.95  |
| 58 to 52mm: (GBSDR5852) .....     | 6.95  |
| 58 to 55mm: (GBSDR5855) .....     | 6.95  |
| 60 to 55mm: (GBSDR6055) .....     | 14.95 |
| 62 to 49mm: (GBSDR6249) .....     | 7.95  |
| 62 to 52mm: (GBSDR6252) .....     | 7.95  |
| 62 to 55mm: (GBSDR6255) .....     | 7.95  |
| 62 to 58mm: (GBSDR6258) .....     | 7.95  |
| 67 to 52mm: (GBSDR6752) .....     | 7.95  |
| 67 to 55mm: (GBSDR6755) .....     | 7.95  |
| 67 to 58mm: (GBSDR6758) .....     | 7.95  |
| 67 to 62mm: (GBSDR6762) .....     | 7.95  |
| 72 to 55mm: (GBSDR7255) .....     | 9.95  |
| 72 to 58mm: (GBSDR7258) .....     | 9.95  |
| 72 to 62mm: (GBSDR7262) .....     | 9.95  |
| 72 to 67mm: (GBSDR7267) .....     | 9.95  |
| 77 to 62mm: (GBSDR7762) .....     | 9.95  |
| 77 to 67mm: (GBSDR7767) .....     | 9.95  |
| 77 to 72mm: (GBSDR7772) .....     | 9.95  |
| 82 to 67mm: (GBSDR8267) .....     | 19.95 |
| 82 to 72mm: (GBSDR8272) .....     | 19.95 |
| 82 to 77mm: (GBSDR8277) .....     | 19.95 |

### Series Adapter Rings

|                                       |      |  |      |
|---------------------------------------|------|--|------|
| 29.5mm to Series 5 (GBAR29.5S5) ..... | 7.95 | 49mm to Series 7 (GBAR49S7) .....      | 6.95 |
| 30.5mm to Series 7 (GBAR30.5S7) ..... | 7.95 | 52mm to Series 7 (GBAR52S7) .....      | 9.95 |
| 34mm to Series 7 (GBAR34S7) .....     | 7.95 | 55mm to Series 7 (GBAR55S7) .....      | 9.95 |
| 37.5mm to Series 5 (GBAR37.5S5) ..... | 7.95 | 58mm to Series 7 (GBAR58S7) .....      | 9.95 |
| 37mm to Series 7 (GBAR37S7) .....     | 7.95 | 62mm to Series 7 (GBAR62S7) .....      | 9.95 |
| 39mm to Series 7 (GBAR39S7) .....     | 7.95 | 67mm to Series 7 (GBAR67S7) .....      | 9.95 |
| 40.5mm to Series 5 (GBAR40.5S5) ..... | 6.95 | 72mm to Series 7 (GBAR72S7) .....      | 9.95 |
| 43mm to Series 5 (GBAR43S5) .....     | 6.95 | 77mm to Series 7 (GBAR77S7) .....      | 9.95 |
| 43mm to Series 7 (GBAR43S7) .....     | 7.95 | Series 5 to Series 6 (GBSURS5S6) ..... | 9.95 |
| 43.5mm to Series 5 (GBAR43.5S5) ..... | 6.95 | Series 5 to Series 7 (GBSURS5S7) ..... | 9.95 |
| 43.5mm to Series 7 (GBAR43.5S7) ..... | 7.95 | Series 6 to Series 5 (GBSDRS6S5) ..... | 9.95 |
| 46mm to Series 5 (GBAR46S5) .....     | 6.95 | Series 7 to 52mm (GBSDRS7S2) .....     | 9.95 |
| 46mm to Series 7 (GBAR46S7) .....     | 7.95 | Series 7 to Series 5 (GBSDRS7S5) ..... | 9.95 |
| 48mm to Series 5 (GBAR48S5) .....     | 6.95 | Series 7 to Series 6 (GBSDRS7S6) ..... | 9.95 |
| 48mm to Series 7 (GBAR48S7) .....     | 6.95 | Series 8 to Series 7 (GBSDRS8S7) ..... | 9.95 |

### Macro Couplers (Lens Stacking Rings)

Designed to allow the photographer to face two lenses together, via male-to-male couplers, enabling high quality macro images. It will work by reversing a standard lens to the front of a telephoto lens.

|                               |      |                               |      |
|-------------------------------|------|-------------------------------|------|
| 49mm to 49mm (GBMC49) .....   | 7.95 | 52mm to 55mm (GBMC5255) ..... | 7.95 |
| 49mm to 52mm (GBMC4952) ..... | 7.95 | 52mm to 58mm (GBMC5258) ..... | 7.95 |
| 49mm to 55mm (GBMC4955) ..... | 7.95 | 55mm to 55mm (GBMC55) .....   | 7.95 |
| 49mm to 58mm (GBMC4958) ..... | 7.95 | 55mm to 58mm (GBMC5558) ..... | 7.95 |
| 52mm to 52mm (GBMC52) .....   | 7.95 | 58mm to 58mm (GBMC58) .....   | 7.95 |

### Filter Stack Caps

Metal filter stack caps protect filters from dust and scratches while they are not being used. Simply screw the filters together, then screw these stack caps on the top and bottom. Great for storing filters when not in use!

|                                      |       |
|--------------------------------------|-------|
| 49mm Filter Stack Cap (GBSC49) ..... | 12.95 |
| 52mm Filter Stack Cap (GBSC52) ..... | 12.95 |
| 55mm Filter Stack Cap (GBSC55) ..... | 12.95 |
| 62mm Filter Stack Cap (GBSC62) ..... | 16.95 |
| 67mm Filter Stack Cap (GBSC67) ..... | 16.95 |
| 72mm Filter Stack Cap (GBSC72) ..... | 16.95 |
| 77mm Filter Stack Cap (GBSC77) ..... | 16.95 |

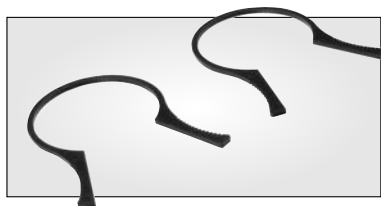
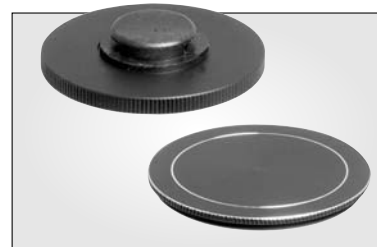

### Filter Wrenches

These are a set of two identical plastic "squeeze-type" wrenches. They may be helpful in removing a "stuck" filter from your lens.

|                                      |      |
|--------------------------------------|------|
| For 46-55mm filters (GBFW) .....     | 3.50 |
| For 62-82mm filters (GBFW6277) ..... | 4.95 |

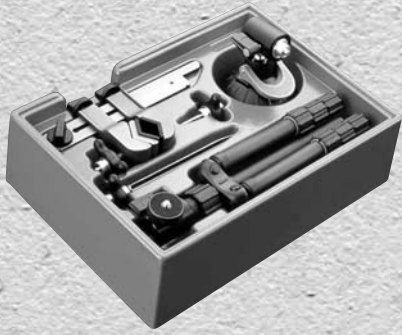



# The 35mm SLR Photo

SourceBook

## Section 5

### Tripods and Accessories

|                       |         |
|-----------------------|---------|
| Acratech.....         | 424     |
| Arca Swiss.....       | 425     |
| Benbo .....           | 426-427 |
| Berlbach .....        | 428-429 |
| Cullman.....          | 430-435 |
| Davis & Sanford ..... | 436-437 |
| Ergorest .....        | 438     |
| FLM .....             | 439-440 |
| Foba .....            | 440-441 |
| Giottos.....          | 442-445 |
| Gitzo .....           | 446-461 |
| Hakuba .....          | 462     |
| Impact.....           | 463     |
| Kaiser .....          | 467     |
| Linhof.....           | 464-465 |
| Majestic.....         | 466-467 |
| Manfrotto.....        | 468-485 |
| Novoflex .....        | 486-492 |
| Slik.....             | 493-505 |
| Sunpak.....           | 506-511 |
| Studio Ball.....      | 511     |
| Tiltall .....         | 512     |
| UltraPod .....        | 512     |
| Velbon .....          | 513-519 |
| Wimberly .....        | 520-523 |

# ACRATECH

## ULTIMATE BALLHEAD

TRIPODS

424

The Acratech Ultimate Ballhead is the most efficient design ever created for combining low mass with incredible stopping power. Available with or without an installed Arca-type quick release clamp, it is an ideal head for those that don't need the progressive tension control of the heavier (and more expensive) Arca-Swiss B1. It can be combined with a Wimberley Sidekick to give exceptional gimbal-type control of all but the most gargantuan 35mm and medium format super telephoto lenses.

The Ultimate Ball Head will hold more weight more securely than ball heads many times its size. It is designed to hold 35mm, medium format and smaller large format cameras securely in any position, and has been tested to hold 25 lbs in any position. Tripod connection thread is 3/8"-16, and includes a reducer bushing so it will also fit 1/4"-20 threads and all standard camera tripods.

All components are precision C.N.C. (computer-numerically controlled) machined from solid stock and all structural components are machined from aircraft 6061-T6 aluminum. All threaded fasteners are machined from stainless steel and all bearing surfaces are machined from a special copolymer similar to Teflon.



### FEATURES

- ◆ Solid precision feel, absolutely no migration after tightening the clamp
- ◆ Silky-smooth black anodized finish for precise positioning
- ◆ Fully captive controls will not come off from prolonged vibrations
- ◆ Open design facilitates quick maintenance
- ◆ Calibrated panning bed
- ◆ "Dry" ball does not attract dirt or dust
- ◆ Full movements allow any camera position
- ◆ Compatible with Kirk, Arca, R.R.S., and many other QR plates
- ◆ Fits all standard tripods (1/4"-20 and 3/8"-16 threads)
- ◆ Weighs less than 1 lb. with quick release clamp, easily holds over 25 lbs. at any angle.

**Ultimate Ballhead 1110 (ACUBHQKRK):**  
With Arca-type Quick Release Clamp & Independent Panning Lock & Rubber Main Control Knob (Requires Plate) .....**279.95**

**Ultimate Ballhead 1113 (ACUBHKR):**  
Same as 1110 without quick release clamp and plate.....**229.95**

**Ultimate Ballhead 1114:**  
Same as 1110 except with rubber pan and quick release knob .....**289.95**

**Ultimate Ballhead 1115 (ACUBHQKRKLDP):**  
Same as 1114 except the quick release clamp has a spring-loaded detente pin.....**299.95**

**Ultimate Ballhead 1116:** Same as 1113 except with rubber pan knob .....**239.95**

**Ultimate Ballhead 1111 (ACUBHQKML):**  
With Arca-Type Quick Release Clamp and Independent Panning Lock & Metal Knob (Requires Plate) .....**269.95**

**Ultimate Ballhead 1112 (ACUBHKML):**  
Same as 1111 without quick release clamp and plate.....**219.95**

### CLAMPS & PLATES

**1127 Arca-Type Quick Release Clamp (ACQRC):** With 3/8"-16 threaded hole.....**79.95**

**2135 Arca-Type Quick Release Plate (ACQRPCIVPB):** For Canon EOS-1/1N/1v & EOS-3 cameras with PB-E1 or PB-E2 Boosters.....**39.95**

**2136 Arca-Type Quick Release Plate (ACQRPCIV):** For Canon EOS-1/1N/1v & EOS-3 cameras without PB-E1 or PB-E2 .....**39.95**

**2137 Arca-Type Quick Release Plate (ACQRPLX):** For Leica R4, R5, R6 or R7, Nikon F2, F3, FA, FE, FG or FM and Pentax LX, MX & ZX5 Cameras .....**39.95**

**2138 Arca-Type Quick Release Plate (ACQRPE7):** For Canon Elan 7/7N/7E/7NE (without grip); Nikon D100 (without grip), 8008, 8008S, N70, N80 and Contax RTS-3 cameras .....**39.95**

**2139 Arca-Type Quick Release Plate (ACQRPNF5):** For Nikon F5.....**39.95**

**2140 Arca-Type Quick Release Plate (ACQRPNF100):** For Nikon F100.....**39.95**

**2141 Arca-Type Quick Release Plate (ACQRPNF100MB):** For Nikon F100 with MB-15 Grip ..**39.95**

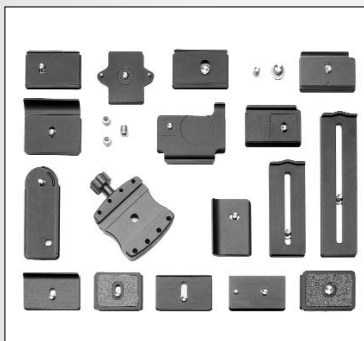

For Any Inquiries Regarding Your Order, Call Our Customer Service:  
(800) 221-5743 • (212) 239-7765 • FAX: (800) 947-2215 • (212) 239-7549



# ARCA SWISS

## BALL HEADS

The unique shape of Arca Swiss Monoballs (an ellipse rather than a sphere) is what separates them from all others. Due to its elliptical nature, they eliminate the need to constantly modulate the tension. The load stays exactly where you tell it to once locked into position. A separate control is set to apply a constant minimum friction, which allows you the peace of mind that comes with knowing your gear will never move of its own volition. The heavier your gear, the more the advantages of the Arca Swiss become evident. The exquisite finish adds to the exact positioning capacity.

**There are two types of ballheads available:** The B1 Series is a single axis rotation ball head with one locking knob. The B1e is an economic model without panning capabilities, the B1 Standard has panning capabilities and the B1G is the large model — all sold with different camera mounting devices. All Arca ballheads mount onto 3/8"-16 tripod screws. The B2, which is built on the double axis rotation, allows movement around two distinct axes due to two separate balls encapsulated into one another and two individual locking knobs.

### B1 MonoBall

The B1 ballhead is the standard by which other ball heads are judged. The ball isn't spherical so that as you tip the lens more and more from the horizontal, the resistance increases. This can prevent "ball head flop" which is what happens when the center of gravity shifts as you tilt a large lens to the point where gravity takes over and the lens flops over and hits the tripod. The B1 can handle any normal lens up to about a 600/4, yet it weighs under 2 lbs. The B1e Monoball is a starter head with a quick release system, that is suited for users who do not need separate panning adjustment. The B1G Monoball (giant) displays the largest aspheric ball within the whole B1 product line. It secures the best possible camera guidance as well as positioning of the largest and heaviest cameras and lenses.



### B2 MonoBall

The B2 incorporates all the features of the B1, but adds the attributes of a 3-dimensional tilting device. For the first time an appliance designed as a ball head allows separate movements according to the tilting method. One ball placed within the other, and both controlled in their progressive cushioning behavior by two satin-smooth tightening knobs. Tightening knobs lock the basic setting, and the panorama runs smooth and vibration-free. It can be fixed in any position whatsoever. To respond to the most challenging demands made on the professional photographer, the B2 Monoball is fitted with the fast and firm Arca-Swiss quick-set plate.



**Monoball B1G (ARB1GQRF):** With independent panning lock and Flip-Lock Quick Release. Requires plate. Supports 200 lbs. ....**599.95**

**Monoball B1G (ARB1GQR):** With independent panning lock and Quick Release. Requires plate. Supports 200 lbs. ....**499.95**

**Monoball B1 (ARB1QRF):** With independent panning lock and Flip-Lock Quick Release. Requires plate. Supports 90 lbs. ....**429.95**

**Monoball B1 (ARB1QR):** With independent panning lock and Quick Release. Requires plate. Supports 90 lbs. ....**399.95**

**Monoball B1e (ARB1EQRF):** With Flip-Lock Quick Release. Requires plate. Supports 90 lbs. ....**358.95**

**Monoball B1e (ARB1EQR):** With Quick Release. Requires Plate. Supports 90 lbs. ....**314.95**

**B2 3-Way Ballhead (ARB2QRF):** With independent panning lock and Flip-Lock quick release. Requires plate. Supports 150 lbs. ....**775.95**

**B2 3-Way Ballhead (ARB2QR):** With independent panning lock and Quick Release. Requires plate. Supports 150 lbs. ....**649.95**

### Quick Release Adapters (Requires plate)

With Flip-lock and 3/8" (ARQR8438FL) or 1/4" (ARQR84.25FL) thread. 3.3" length .....**149.95**

With Flip-lock and 3/8" (ARQR6038FL) or 1/4" (ARQR60.25FL) thread. 2.3" length .....**139.95**

3/8" (ARQR8438) or 1/4" (ARQR84.25) thread. 3.3" length.....**116.95**

With 3/8" thread (ARQR6038). 2.3" length.....**112.95**

With 1/4" thread (ARQR60.25). 2.3" length.....**104.95**

### Quick Release Plates

With two 1/4" screws for Canon (ARQRPC) or Nikon (ARQRPN) telephoto lenses.....**53.95**

With 1/4" (ARQRPL.25) or 3/8" (ARQRPL38) screw for Leica M cameras .....**49.95**

24 x 36mm Small Plate (ARQRP35) for 35mm.....**44.95**

40mm Universal Plate (ARQRP40.25) with 1/4" screw and rubber surface.....**44.95**

80mm Universal Plate with 1/4" (ARQRP80.25) or 3/8" (ARUCP38) screw .....**44.95**

TRIPODS

425



# BENBO

## TRIPODS

TRIPODS

426

*Stability linked to versatility and weight are the prime considerations when choosing a tripod. For over 35 years Benbo tripods have offered photographers a unique combination of these factors.*

*The tubular aluminium construction of the legs offers the best possible combination of weight and rigidity. Each leg can be independently positioned, made possible by the tripods unique, highly flexible main joint, which enables each leg to swing through a complete 360°. The center column can also be swung through 360°, producing a combination that allows the camera to be positioned at almost any point.*

*Whether used in the standard configuration with a vertical center column, down at ground level with legs splayed out, or with one of the legs pointing upward finding support from a tree or wall, Benbo tripods can always be relied upon to give complete stability.*

*All models are constructed from drawn tubing with no internal seams, with the lower tubing having sealed feet, allowing the tripod to be stood in water, mud or snow up to the leg joint.*

### **Benbo Classic No 1 & 2 Tripods**

These heavy-duty tripods offer great stability and are capable of supporting the heaviest of camera equipment. They are both constructed from the same tough aluminium tubing, with the No 2 tripod offering extra height with its longer legs. The double ended center column offers a choice of standard 3/8" or 1/4" fixing for ball & socket heads.

### **Benbo Trekker Mk 2**

This award-winning tripod now has added features making it the most versatile tripod in the Benbo range. The swivel joint at the top of the center column can be fully adjusted through 180° offering even more flexibility when positioning the camera. This feature makes the Trekker MK2 ideally suited when subjects need to be photographed from above or at a low angle. The Trekker MK2 will support the majority of today's SLRs and medium format cameras. However stability is directly related to weight and the provision of a hook at the lower end of the center column, allows the temporary addition of extra weight (e.g. a camera bag) to give greater stability when long lenses are in use on the camera.

### **Benbo Mini Trekker**

All the features of the Trekker Mk2 but with shorter fixed length legs. This lightweight compact tripod is ideal for use when photographing flowers and other low-level nature subjects, or indoors as a tabletop tripod.

- ◆ The flexibility of the leg joint mechanism combined with the ability to swing the center column through 180° allows the camera to be positioned close to ground level (Ideal for macro work).
- ◆ The camera mount on the center column can be adjusted through 180° offering unique flexibility particularly when used in conjunction with a ball and socket head.
- ◆ Ergonomically designed knobs allow the height of the tripod legs to be adjusted with only one hand.
- ◆ When long lenses are in use, greater stability can be obtained by hanging your camera bag or other weight onto the hook located on the end of the center column. This feature avoids the necessity of carrying very heavy tripods on location.

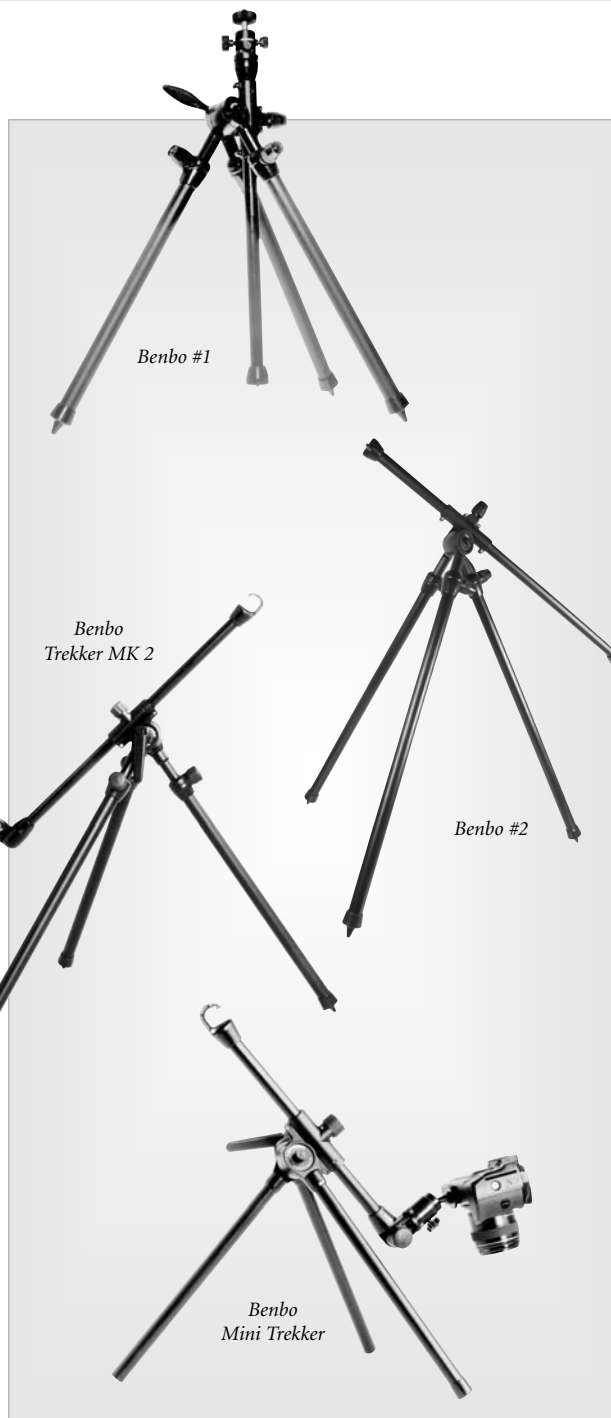

# BENBO

## TRIPODS & HEADS

TRIPODS

427

### BENBO TRIPOD SPECIFICATIONS

| Classic Tripods    | SKU   | Extends to | Closes To | Weight   | Price \$ |
|--------------------|-------|------------|-----------|----------|----------|
| Benbo 1            | BEB1Z | 62"        | 33"       | 7.5 lbs  | 179.95   |
| Benbo 2            | BEB2Z | 101"       | 45"       | 8.27 lbs | 199.95   |
| Benbo Trekker Mk 2 | BET   | 61"        | 33"       | 4.5 lbs  | 119.95   |
| Benbo Mini Trekker | BEMT  | 28"        | 21.5"     | 3.4 lbs  | 79.95    |

**Benbo 1 Kit (BEBSK):** Includes Pro ball and socket head and carry bag .....**299.95**

**Benbo 2 Kit (BEBSKQ):** Includes Pro ball and socket head and carry bag .....**339.95**

**Benbo Trekker Kit (BETK):** Includes Pro ball and socket head and carry bag .....**179.95**



### CARRY BAGS

Designed to carry its respective tripod with a ball & socket head fitted. These bags have two handles plus a shoulder strap.

**36" Tripod Case for Benbo 1 (BETC1)** .....**24.95**

**48" Tripod Case for Benbo 2 (BETC2)** .....**26.95**

**Tripod Case for Trekker (BETCT)** .....**20.99**

### Benbo Compact Ball & Socket Heads

A range of high precision ball & socket heads turned from solid aluminium alloy on the latest CNC machines, ensuring superb quality of construction. Knurled aluminium knobs operate the unique locking mechanism ensuring positive locking and smooth operation of the ball joint. The most important feature of any ball & socket head is the diameter of the ball itself, which is directly related to the weight of camera it will carry, a factor which has played an important part in the design of Benbo Ball & Socket heads. A cork pad on the camera mounting plate ensures that cameras are safely fixed in position.

#### Compact Ball & Socket Head (BEB299)

The standard ball & socket head supplied with Trekker kits. Although compact in overall dimensions, its 25mm ball will support the majority of 35mm SLR cameras. The large textured locking knob ensures quick and positive adjustment of the camera angle .....**59.95**

#### Compact Ball & Socket Head with Panning Base (BEB300)

Same as above with a revolving base which can be adjusted and locked independently from the ball joint, giving it even greater flexibility .....**79.95**

#### Professional Ball & Socket Head (BEB306)

A highly specified ball & socket head with a 29mm ball capable of supporting 35mm SLRs even when equipped with long lenses. A separate adjustment knob allows the ball movement to be tensioned to suit the weight of camera to be supported. A further large knurled knob separately locks the revolving base .....**119.95**



Compact Ball & Socket Head (BEB299)

Compact Ball & Socket Head with Panning Base (BEB300)



Professional Ball & Socket Head (BEB306)

### Trekker 2-Section Monopod with Swivel Tilt Head

This two-section monopod utilizes the 180° tilting camera mount from the Trekker tripod, making it one of the most versatile monopods on the market. The tilting mount allows the camera to be used in both landscape and portrait modes without the need of an additional ball and socket head. It extends to 63", closes down to 35", and weighs 21 oz.



**BEMPT** .....**35.95**

**ORDER & INFO. (212) 502-6340 • FAX: (212) 239-7770 (800) 947-7008  
1-800-290-6750 • www.bhphotovideo.com**



# BERLEBACH

## WOODEN TRIPODS

TRIPODS

428



### **Ash Wood Tripods—The Genuine Alternative**

Manufactured for almost a hundred years in Mulda, Berlebach ash wood tripods have won numerous awards for outstanding design achievement. The best value for the money, wood simply does not resonate vibrations such as other materials, instead it gobbles them up. A wooden tripod placed in a shallow stream may be vibrating quite a bit where the legs meet the water, but up at the column it is dead as a doornail. Putting a laser pointer on top of a metal, carbon fiber and wood tripod and shaking the legs of each clearly displays the advantage. The laser pointer's beam upon the wood tripod will have come to a rest much quicker than the others, and additionally its resonating disturbances will be smaller as well. This will assuredly show up in your pictures! Berlebach has been using ash wood - a renewable raw material - for almost 100 years. The processed wood, known as sport ash, comes from the best controlled forests in Europe. It is especially hard-wearing and elastic, as well as resistant to the forces of nature. Having been dried, the wood is stored, prior to processing, for about another two years so as to eliminate any tension within the wood as a result of growth. Several layers of protecting varnish guarantee long-term care of the wood's surface.

Seven tripod-leg lengths can be combined with six different light-metal mounting heads to make up a complete tripod. This enables photographers to select the most suitable tripod for the assignment or particular type of camera in question. And, special attention can also be given to the vital factor of weight.

### **Wooden Advantages:**

- ◆ Wood is electrically non-conductive, thus preventing the damaging effects of electromagnetic fields and electrostatic charging.
- ◆ Thanks to their favorable own weight, Berlebach ash wood tripods deliver optimum stability under load.
- ◆ Berlebach tripods are robust and ideal for tough day-to-day use.
- ◆ Berlebach ash wood tripods can be used in climatic extremes. They have served, for instance, on expeditions to the north and south pole, in the desert and the rain forest.
- ◆ Handling a wood tripod in extremes of heat or cold is quite a different experience than that of a metal or even carbon fiber tripod. Unlike metal tripods, wooden tripods warm up only very slowly in direct sunlight. Under extremely cold conditions, you can touch a wooden tripod without having to wear gloves.

### **TABLE TOP TRIPOD**

Versatile mini-sized tripod delivering maximum stability. Especially suited for macro photography and as a table-top tripod. Tripod leg height can be varied as desired. A patented sliding mechanism enables leg spread adjustment at 35°, 50° and 85°. Tripod legs have rubber-capped feet.

Table Top Tripod (BE50031) .....107.95



# BERLEBACH

## WOODEN TRIPODS

### 8023/8023G

The 8023 and 8023G (gray ash) are 3-section models and feature a sliding center-column which adds additional height adjustment. The center-column is made from precision-drawn light-metal tubing and is built into the tripod to fit precisely. Use of an extra-short center column (10 cm) enables near-ground-level work.



- ◆ 3-position independent leg spread (20°, 45° and 90°)
- ◆ Dual spiked/rubber tipped feet
- ◆ Leg locks which are unaffected by sand, mud or water
- ◆ Classic stylish appeal
- ◆ Simple to clean

### 2042/3042

The 2042 and 3042 are 2-section models that feature a center column that is incorporated into a levelling base with a bubble level, which provides 30° of quick correction in all directions. For many applications you wouldn't even need a tripod head at all, and of course the closer your camera is to the top of the tripod legs the better off you'll be.



- ◆ Integrated levelling base and center column with bubble level
- ◆ Leg locks are unaffected by sand, mud or water
- ◆ 3-position independent leg spread (20°, 45° and 90°)
- ◆ Dual spiked/rubber tipped feet
- ◆ Simple to clean
- ◆ Classic stylish appeal



### 3032

Mounting head with ball/socket and built-in spirit level, maintenance-free ball seated in high-grade plastic, spring mounted fastening screw - 1/4" standard, 3/8" and 5/8" optional. This

tripod version is equipped with an additional levelling facility to allow precise 30° adjustment in all directions. A very valuable feature when working on uneven ground. Especially recommended for heavy equipment.

- ◆ Mounting head with ball and built-in spirit level
- ◆ Leg locks which are unaffected by sand, mud or water
- ◆ 3-position independent leg spread (20°, 45° and 90°)
- ◆ Dual spiked/rubber tipped feet
- ◆ Simple to clean
- ◆ Classic stylish appeal



### 8043

The 8043 is the flagship 3-section model of the Berlebach line. The center column is incorporated into a levelling base with a bubble level, and this provides 30° of quick correction in all directions. For many applications you wouldn't even need a tripod head at all, and of course the closer your camera is to the top of the tripod legs the better off you'll be.

- ◆ Integrated levelling base and center column with bubble level
- ◆ Leg locks are unaffected by sand, mud or water
- ◆ 3-position independent leg spread (20°, 45° and 90°)
- ◆ Dual spiked/rubber tipped feet
- ◆ Simple to clean
- ◆ Classic stylish appeal

#### BERLEBACH TRIPOD SPECIFICATIONS

| SKU#                   | BE8023   | BE8023G  | BE2042    | BE3042   | BE3032                  | BE8043    |
|------------------------|----------|----------|-----------|----------|-------------------------|-----------|
| Maximum Height         | 69.3"    | 69.3"    | 64.5"     | 72.8"    | 55.9"                   | 68.9"     |
| Minimum Height         | 20.5"    | 20.5"    | 20.5"     | 20.5"    | 3.5"                    | 20.5"     |
| Folded Length          | 21"      | 21"      | 32"       | 37"      | 35"                     | 28.3"     |
| Load Capacity          | 22 lbs.  | 22 lbs.  | 26.5 lbs. | 22 lbs.  | 26.5 lbs.               | 17.6 lbs. |
| Leg Sections           | 3        | 3        | 2         | 2        | 2                       | 3         |
| Head Mount Thread Size | 1/4"-20  | 1/4"-20  | 1/4"-20   | 1/4"-20  | 1/4"-20 (spring-loaded) | 1/4"-20   |
| Weight                 | 6.2 lbs. | 6.2 lbs. | 7 lbs.    | 7.7 lbs. | 7.1 lbs.                | 6.2 lbs.  |
| Price                  | 174.95   | 216.95   | 224.95    | 239.95   | 209.95                  | 239.95    |

# CULLMAN

## MAGIC SERIES

TRIPODS

430

### Magic II Tripod

Known as the most compact, full height tripod available today, the Magic II is the tripod which photographers and enthusiasts alike can take with them wherever they go, due to its compact size. When folded flat, the magic measures a mere 13 $\frac{3}{4}$ " high and 1.5" thick, and can fit into the bottom pocket of many camera bags.

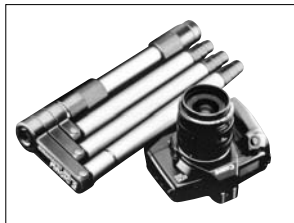

Assembled in no time at all, it provides remarkable stability, even when fully extended. The Magic II can also be converted into a full height monopod. Simply unscrew one of the legs and join it up to the removable center column. The unique one-twist mechanism allows the tripod legs to lock at one quick turn of the topmost leg portion. The entire tripod is anodized in a

cobalt matte finish for reflection free photos. The Magic II comes equipped with a removable ballhead, Quick Release and plate, and weighs only 2.5 lbs.



### Mini Magic



A smaller sized Magic tripod with the same unique "fold flat" design as Magic II. It includes a sliding, reversible

center column with a ballhead. A small 8 $\frac{1}{2}$ " length when closed, the Mini Magic extends to over 21", yet weighs just 1.5 lbs. Its folded dimensions are 8.5 x 6 x 1.5".

**Mini Magic (CUMM) .....69.95**

### Chestpod Magic

The special tripod for steady camera control after a long day. To prevent the arms getting tired, the weight of the camera is transferred to the body. When not actually shooting both your hands are free. Features a sliding column, quick coupling system and a quick release ball head.

**Chestpod Magic (CUCM).....69.95**

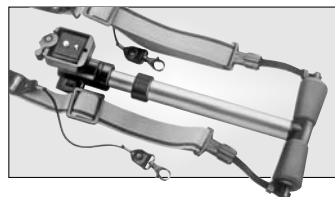

### Clamp Magic



For situations in which, for some reason or other, a tripod can not be used. The clamp provides perfect camera support on round, angular

or irregularly shaped objects. Clamp Magic features a sliding column and includes a ball head with a 1/4-20" standard screw. It has a load capacity of 5.5 lbs.

**Clamp Magic (CUCMQ).....76.95**

### MAGIC SERIES SPECIFICATIONS

|                        | Magic 2  | Mini Magic | Chestpod Magic |
|------------------------|----------|------------|----------------|
| Load Capacity          | 7.7 lbs. | 6.6 lbs.   | 6.6 lbs.       |
| Minimum Usable Height  | 13"      | 13"        | 13"            |
| Maximum Extension      | 57"      | 21"        | 15.5"          |
| Leg Sections           | 4        | 1          | 2              |
| Center Column Sections | 2        | 1          | 1              |
| Weight                 | 2.5 lbs. | 1.5 lbs.   | 1 lb.          |

Since 1955, Cullmann has been manufacturing professional tripods and accessories. The tripods can be extended with the many variable system accessories. Cullmann tripods are noted for their outstanding stability and ease of handling. The "quick release" system that allows you to put on and take off your photo equipment from your tripod was invented by Mr. Cullmann, and is now a universal system of camera mounting. Many other innovations, such as built-in carrying handles, hexagonal shaped legs, top lock adjustment levers, and center columns all add up to the most extensive line of advanced amateur and professional tripods and accessories available today.



EQUIPMENT LEASING AVAILABLE

# CULLMAN

## TITAN 100

### Titan Professional with Air Dampened Center Column

The CT-100 is a heavy-duty, professional-grade tripod with a built-in pneumatic center column. That means your camera rides on air pressure. At the touch of a button, air pressure in the column is released and the camera is gently lowered. A collar lock allows exact positioning of the column at any point of its travel. Thick 29/35mm thick leg segments insure a sturdy set-up for any photo equipment. The CT-100 weighs 8.6 lbs, has a 28° leg spread, and extends to a working height of 69".

- ◆ Exclusive "top lock design" allows all height adjustments to be made from the top collar of the tripod, provided by the unique 3-way lock system. With the release mechanism located at the top of the tripod, your eye never leaves the viewfinder. Minute adjustments can be made with a single sure movement, allowing for precise positioning of any camera.
- ◆ 2-section legs ensure that dirt, water, sand, and dust don't enter into the leg channels, causing undue friction and binding.
- ◆ Large, sure-grip rubber feet insure a firm tripod-to-surface contact.
- ◆ Trapezoidal shaped legs allow the tripod to bear greater weight, and to resist bending and swaying.
- ◆ Special non-reflective (Anodized Cobalt Grey) finish helps to protect your photos from glare.
- ◆ Specially designed locking system (Tripod Stud Lock), is tightened or loosened with a provided hex wrench insures sure, positive contact between tripod, ballhead, and camera.



|                                |          |
|--------------------------------|----------|
| <b>Load Capacity:</b>          | 154 lbs. |
| <b>Minimum Usable Height:</b>  | 28.7"    |
| <b>Maximum Extension:</b>      | 63.4"    |
| <b>Leg Sections:</b>           | 2        |
| <b>Center Column Sections:</b> | 1        |
| <b>Weight:</b>                 | 8.6 lbs. |

TRIPODS

431

## OPTIONAL ACCESSORIES FOR THE TITAN 100

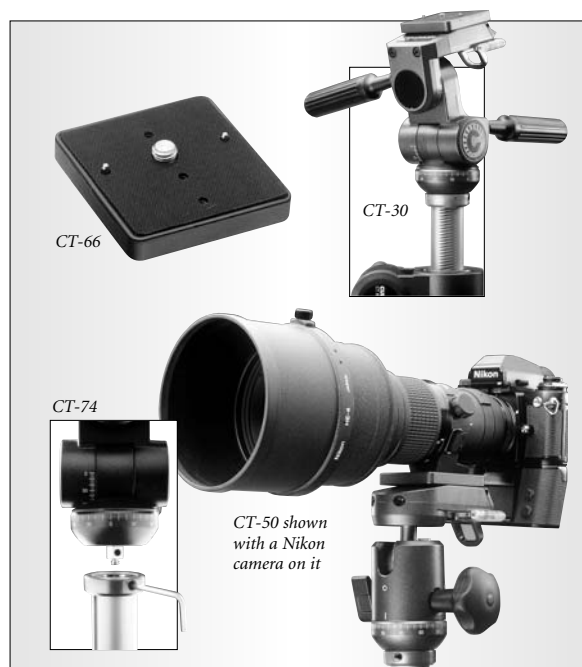

- CT-11 2-Way Video Tilt Head (CUVHT)**  
Features ultra-smooth pan and tilt .....154.95
- CT-22 Ball and Socket Head (CUBHP)**  
A medium-sized ball head that provides excellent support, a features a quick-release top and built-in bubble level .....69.95
- CT-30 3-way Pan Head (CUFH)**  
Traditional 3-way pan head with ultra-smooth pan and tilt. Compatible with all Cullman quick release plates.....239.95
- CT-50 Deluxe Ball and Socket Head (CUCT50)**  
Even when you are using extremely heavy lenses, the camera must remain in its fixed position. No problem for this professional Ball and Socket Head. Free adjustment of the camera in any direction. One short turn and the camera is locked firmly in position once more. Full 360° panning is achieved without the need of releasing the ball joint thanks to a separate safety catch, which can be pulled outwards and released in any position. Graduation markings help you to accurately set the position (93° tilt range). Load capacity 13 lbs., weighs 3 lbs. ....CALL
- CT-66 3/8" Quick Release Camera Plate (CUQRP38Q)** .....36.95
- CT-74 Hexagonal, Reversible 1/4" to 3/8" Thread Adapter (CUTA)**  
Fits all Titan tripods. Replacement .....12.50



# CULLMAN

## UNIVERSAL SERIES

TRIPODS

432

### Universal Maximo Tripod

*Ideal for photo, video, or digital photography, this tripod offers outstanding value as well as sturdy support. 5-section aspherical shaped legs offers greater rigidity than round legs. Additional support is provided by a center brace. This extremely lightweight and portable tripod features a quick release 3-way panhead with camera plate, and is finished in cobalt grey.*

**Universal Maximo Tripod (CUUMQ):** The Maximo is a 5-section quick-pull, super lightweight tripod. It features a crank column as well as a center brace with lock to make it rock solid. Includes a 3-way pan head with quick release. Extends to 47.6", folds to a compact 14" and supports up to 6.6 lbs. ....54.95



### Universal 2800 Photo Tripod

*Ideal for photo and digital use, the Universal 2800 features trapezoidal shaped legs to insure excellent stability and a center brace for additional support. It comes in a cobalt gray anodized matte finish for long-life and reflection-free photography. The Universal 2800 includes a 3-way panhead with a quick release plate.*

**Universal 2800 Photo Tripod (CU2800):** The Universal 2800 features a 3-way heavy duty panhead, while sturdy 25mm trapezoidal shaped legs and center support allow maximum stability. One touch section locks insure slip-proof height adjustments. Center column can be removed and converted into a monopod. It extends to 58", and folds down to 23" .....109.95

### Universal 3000 Series Tripods

*Universal 3000 Series tripods feature 29mm thick leg sections and offer absolute control of your still or digital photo equipment — even under the most demanding shooting conditions. Unique trapezoidal closed leg design helps to seal out water, dirt, sand, etc. The exclusive cobalt gray matte anodized finish insures reflection-free photography. Cullman's largest 3-way one-touch panhead includes a quick release plate. Built-in bubble levels and optional mounting plate for flash and macro accessories make the 3000 series tripods one of the most versatile lines available today.*

#### Universal 3135

##### Photo Tripod (CUU3135)

The Universal 3135 features a 3-way quick release pan head. It has a sliding center column with a self-locking screw. It extends to 61" and folds down to 25". It weighs only 5 lbs.....104.95

#### Universal 3230

##### Photo Tripod (CUU3230)

The 3230 features a 3-way quick-release pan head and a built-in carrying handle with a retractable shoulder strap. The gear-controlled center-column allows for precise positioning of photo or digital equipment. It extends to 60", folds down to 24" and weighs 4.5 lbs. ....109.95



#### Universal 3430

##### Photo Tripod (CU3430)

Ideal tripod for 35mm cameras with long lenses. The large 3-way panhead features a quick release platform and comes with a quick release plate. Sturdy center column support provides the utmost in stability. Center column converts instantly into a full height monopod with quick release panhead. It extends to 60" and folds down to 24" .....144.95

#### Universal 3335

##### Macro Tripod (CUUM)

Solid tripod, perfect for macro or table-top use. Center column is both removable and reversible, allowing for low camera angles (down to 3"). Folds down to a compact 26" extends to 61". The 3-way pan head includes a sure-lock quick release platform and large 1/4 quick change plate. Includes tough, lightweight nylon carrying case.....119.95



# CULLMAN

## UNIVERSAL SERIES

### Universal Twin Rail 100/200

Developed in Germany, the Twin Rail 100 and Twin Rail 200 are rugged but lightweight outdoor tripods that combine modern technology and precision craftsmanship. Features include an advanced twin trapezoid profile legs design, air cushioned, geared center column, and a built-in carrying handle with strap. The head is removable to fit other 1/4"-20 accessories. Twin Rail tripods are great for 35mm photo and compact video cameras.

**Twin Rail 100 (CUTR100):**  
With 3-way fluid effect quick release head. Supports 5.5 lbs .....**69.95**

**Twin Rail 200 (CUTR200):**  
Same as the Twin Rail 100, but it supports 7.7 lbs.....**99.95**

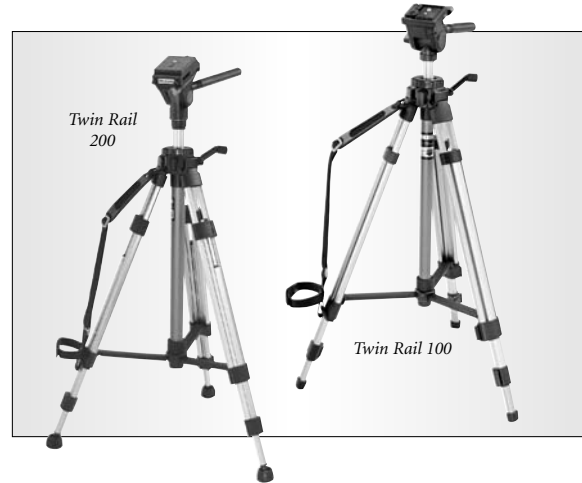

TRIPODS

433

### UNIVERSAL SERIES SPECIFICATIONS

|                        | Maximo   | 2800     | 3135     | 3230      | 3430      | 3335     | Twin Rail 100 | Twin Rail 200 |
|------------------------|----------|----------|----------|-----------|-----------|----------|---------------|---------------|
| Load Capacity          | 5.5 lbs. | 7.0 lbs. | 7.7 lbs. | 7.7 lbs.  | 7.7 lbs.  | 7.7 lbs. | 5.5 lbs.      | 7.7 lbs.      |
| Minimum Usable Height  | 12"      | 24"      | 25"      | 24.8"     | 24.3"     | 24"      | 24"           | 26"           |
| Maximum Extension      | 48"      | 60"      | 61"      | 60"       | 59.5"     | 59"      | 59"           | 64"           |
| Leg Sections           | 5        | 3        | 3        | 3         | 3         | 3        | 3             | 3             |
| Center Column Sections | 1        | 1        | 1        | 1         | 1         | 1        | 1             | 1             |
| Weight                 | 1.5 lbs. | 4 lbs.   | 5 lbs.   | 5.25 lbs. | 5.25 lbs. | 5.6 lbs. | 3 lbs.        | 4 lbs.        |

### Universal System Series Accessories

#### 3020 Quick Release Ball and Socket Head (CUPH)

A special ball head that is freely adjustable in any direction. A quick turn is enough to both release and lock the multi-directional head. It is particularly suitable for fast camera panning to all sides. Includes a large quick release platform and camera plate ..**64.95**

#### 3030 3-way Panoramic Head (CUPHQ)

This larger, heavy-duty head incorporates an easy-grip handle which locks/tightens the infinitely variable vertical adjustment. A quick reference scale is provided to accurately show the degree of angle. As well, the 3030 head incorporates a horizontal positioning lever, perfect for precise camera positioning.....**64.95**

#### 3060 Extension/Macro Arm (CU3060)

Extends your tripods camera to those those hard-to-reach places. The 3060 Extension/Macro Arm has a geared track and pivots both vertically as well as horizontally .....**69.95**

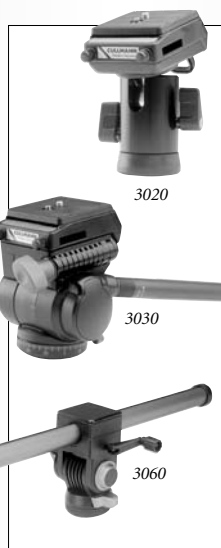

#### CU-70 Quick Release Camera Platform (CUQR)

The same QR platform supplied with all tripods. Great for auxiliary mounting of photo equipment on light arms, camera stands, etc .....**29.95**

#### CU-81 Quick Release Plate (CUQRP.25)

With 1/4" screw .....**13.95**

**CU-83 Quick Release Plate (CUQRP.25SB):** Same as above plate except with stabilizer for long lenses .....**13.95**

#### CU-82 Quick Release Plate (CUQRP38)

With 3/8" screw .....**14.95**

#### CU-3011 Quick Release Plate (CUQRP.25VP)

Large surface camera plate 1/4" with video pin (2000 and 3000 series tripods only).....**18.95**

#### CU-3012 Large Quick Release Plate (CUQRP.25S)

Large surface camera plate with stabilizing bar (2000 and 3000 series tripods only).....**18.95**

**CU-78 Spirit Level (CUSL):** Horizontal and Vertical Levels. "Shoe Mount" foot for mounting on any camera.....**28.95**

**ORDER & INFO. (212) 502-6340 • FAX: (212) 239-7770 (800) 947-7008  
1-800-290-6750 • www.bhphotovideo.com**



# CULLMAN

## TRIPODS

TRIPODS

434

### **Moskito** (CU50006)

An ultra-lightweight elegant mini tripod. As it is only 7.7" long, and weighs just 3 oz., it can easily fit into your camera bag, so you always have it when you need it. It has a 2-way pan head with quick release plate and a comfortable carrying strap. The Moskito is perfect for table-top and travel photography.....CALL

### **Kobold** (CU50009)

The Kobold is an extremely sturdy, all-metal tripod. It is perfect for times that you need a small tripod in the field. It features a quick release tripod head with horizontal and vertical tilt and an adjustable 2-part sliding center column. It also has a comfortable carrying strap. The Kobold has a 7 lb. carrying capacity, is 10" folded, 18" tall, and weighs 8 oz.....CALL

### **Jet Set Tripod** (CUJS)

Cullman's lightweight travelling tripod, the Jet Set features a locking, sliding center column and a 3-way pan head with quick release to control your camera. 4-section round legs add to the stability. It includes a carrying case for fast easy transport. Extends to 51" and folds down to a compact 18". Weighs only 1.5 lbs.....49.95



## Cullman Ballheads

Suitable for mounting on any tripod or 1/4" threaded screw mount, Cullman ballheads are made of hardened steel for maximum strength and durability, and all models tilt 90°.

### **903 Small Ballhead** (CUBHS)

2½ x 1" diameter, weighs 5.3oz. Perfect for compact cameras, SLR's, and smaller video cameras. Supports up to 5 lbs.....29.95

### **904 Medium Ballhead** (CUBHM)

3 x 1½" diameter, weighs 8.2 oz. Can accommodate larger SLR's and mid size video cameras up to 5 lbs .....39.95

### **905 Large Ballhead** (CUBHL)

With independant panning lock. 3½ x 2" diameter, weighs 13 oz. Ideal for long lens photography up to 5 lbs.....54.95

## Monopods

Cullmann monopods provide quick, easy set-up and take-down support for action shots, backpack photography, or any other shooting situation where space, size, or portability is a criteria.

### **CU-741 Monopod** (CUMPDQ)

5-section Monopod with 1/4" camera connecting stud.....36.95

### **CU-1747 Deluxe Monopod** (CUMPD)

Perfect for sports or nature photography. Includes fluid effect 2 way head with Quick Release mount and plate. Also includes retractable 3-prong foot.....64.95

### **CT-304 Titan Professional Monopod** (CUMPCT304)

For photo or video use. Features same one-touch locking system as Titan Tripods. Quick release head and QR plate included. Weighs 5 lbs .....146.95

### **Monofix Monopod** (CUMPDZ)

The Monofix is a 9-section compact monopod with a locking ball head for stepless adjustment. It opens to 56", folds to 12", and weighs 8 oz. It has an attached carrying strap .....44.95

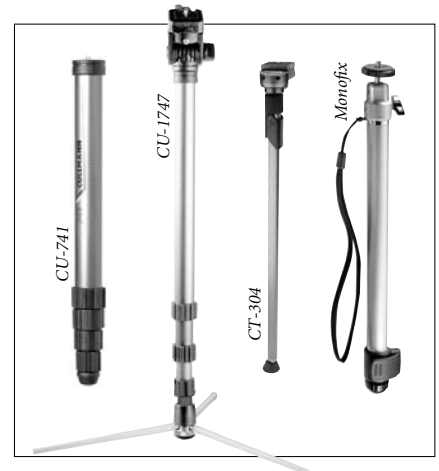

# CULLMAN

## TRIPODS

TRIPODS

435

### Mini and Specialty Tripods

Cullmann Specialty Tripods have been designed to provide photographers with the answers to a variety of camera-mounting problems, especially where size, space, and surface texture might be a consideration.



**CU-50001 Piccolo (CUP)**  
Smaller than a pack of cigarettes, the Piccolo has a 3-way adjustable head and 5 section legs .....**18.95**



**CU-3090 TravelPod (CUTP)**  
Combined shoulder/table top tripod with unique folding shoulder stabilizer. 2 way video head with quick release coupling. Great for cameras, camcorders, and binocular .....**49.95**



**CU-3080 MultiPod (CUMP)**  
Multi-faceted mounting system, great for still or video filming in auto, ship, train, or even small plane. Sure-grip rubber feet and suction cup mounting for smooth surfaces.....**59.95**



*Touring Kit (CUTS).....***119.95**

### TOURING SET

The perfect outdoor tripod, the Touring Set provides any amount of combinations for getting the shot where most other tripods don't even come close. This 5 piece kit is perfect for all still and video applications, when shooting on any ground, from any angle, from any position. Extremely quick to set up, each accessory included in the set can be used either by itself, or in conjunction with any of the other accessories. The Touring Set is a "must have" for any nature or outdoor photographer.

#### Mini-Tripod (CUC)

The heart of the set, this sturdy 3 section tripod has a removable center column which can be reversed for shooting close-ups. A removable ball head is mounted on top of the tripod.....**54.95**

#### Woodscrew (CUWS)

Can be screwed into beams, fence posts, park benches, and tree stumps (never screw into live trees).....**16.95**

#### Universal Clamp (CUCU)

The Universal Clamp ensures secure mounting to round, square, or irregularly shaped objects, such as tree limbs or fence post.....**39.95**

#### Ground Spike (CUGS)

For pushing into any ground like sand, earth, snow, pebbles, etc. Can also be used with the ball head, for positioning of your camera or camcorder.....**16.95**

#### Suction Mount (CUSM)

Gives a safe and sure grip on any smooth surface such as glass, marble, metal, or plastic, or car windows. The ball head handles a load of 6 lbs .....**34.95**

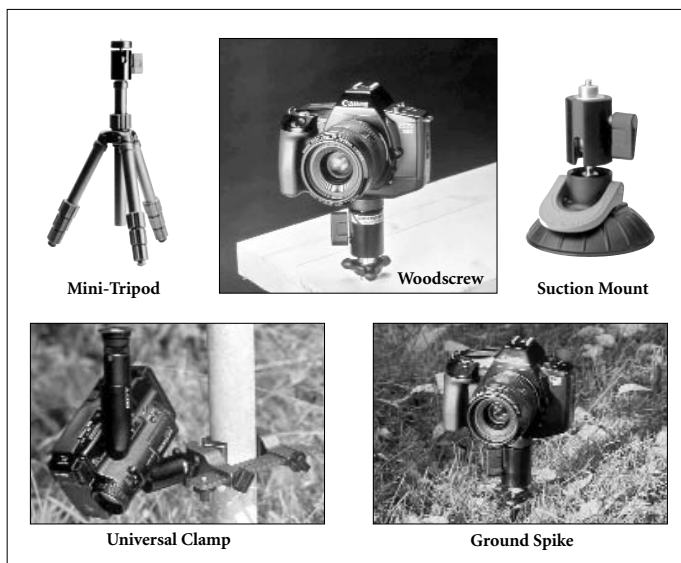

**ORDER & INFO. (212) 502-6340 • FAX: (212) 239-7770 (800) 947-7008  
1-800-290-6750 • www.bhphotovideo.com**



# DAVIS & SANFORD

## LIGHTWEIGHT / PROSUMER TRIPODS

TRIPODS

436

Over the past 60 years, Davis & Sanford has built up a diverse line of well-engineered, sturdy tripods—from low-priced, high value tripods for the weekend snaphooter to versatile, rugged tripods for around-the-clock professionals, and everything in between. All tripods feature protective finishes that resist abrasion under the heaviest use, and have a ten-year warranty.

### LIGHTWEIGHT SERIES

#### **Traveler** (DATQ)

Perfect for digital, video and still cameras weighing up to 4 lbs, the Traveler has 20mm diameter aluminum 3-section legs, and includes a 3-way pan head, a quick release plate, and a bubble level. It offers quick-release leg-locks for fast, sure operation, and a geared centerpost for smooth, precise picture taking. It comes with a soft sided carrying bag.....**19.95**

#### **Explorer** (DAE)

Weighing in at a mere 2.5 pounds, the Explorer features 26mm diameter aluminum 3-section legs and a leg support brace with lock. It comes equipped with a 3-way fluid head (2-way tilt plus pan) which includes a quick release plate and bubble level on base and head. It also has a 12" geared centerpost and built-in carrying handle, and includes a soft sided woven tripod bag.....**39.95**

#### **Ranger** (DARQ)

Great for digital, video and still cameras weighing up to 7 pounds, the Ranger has 27mm diameter aluminum 3-section snap lock legs, a 3-way fluid head with 360° pan plus 2-way tilt, rubber feet, double bubble levels, locking center struts and a carrying handle .....**49.95**



### PROSUMER SERIES

#### **Magnum XT** (DAMXT)

Supplied with a 3-way QR head, the Magnum XT is an "all purpose" tripod with 2-section twist-lock legs. It features Easy Grip foam-cushioned insulated legs, a built-in bubble level, and rubber/retractable spiked feet. It comes with a mounting plate and a case .....**99.95**

#### **Magnum X3T** (DAMX3T)

Similar to the Magnum XT, the X3T has 3-section legs with freeze free, twist turn barrel locks, a 3-way action head with quick release plate, a built-in bubble level and four oversized handles. The foam cushioned legs secure their grip in any weather .....**99.95**

#### **Courier XT** (DACXT)

The Courier XT tripod comes with the FGX10 head, which features Strobframe's quick release and calibrated panning base. The tripod features a bubble level, 3-section quick snap leg locks and a geared centerpost for fast and sure operation, as well as a center brace and a retractable spiked feet for rock steady positioning.....**69.95**

### LIGHTWEIGHT / PROSUMER SERIES TRIPODS

|            | Maximum Height | Maximum Load | Folded Length | Minimum Height | Weight  | Price |
|------------|----------------|--------------|---------------|----------------|---------|-------|
| Traveler   | 50"            | 4 lbs        | 20"           | 21"            | 2 lbs   | 19.95 |
| Explorer   | 59"            | 4 lbs        | 22"           | 23"            | 2.5 lbs | 39.95 |
| Ranger     | 64"            | 7 lbs        | 23"           | 25"            | 4 lbs   | 49.95 |
| Magnum XT  | 66"            | 9 lbs        | 30"           | 29.8"          | 6 lbs   | 99.95 |
| Magnum X3T | 69 1/4"        | 9 lbs        | 25"           | 22 3/4"        | 6.5 lbs | 99.95 |
| Courier XT | 67"            | 9 lbs        | 27"           | 26"            | 5 lbs   | 69.95 |



**ONE HOUR FREE PARKING**  
**AT 349 W. 34th STREET** (with purchase of \$100 or more)

# DAVIS & SANFORD

## TRIPODS & HEADS



### Minipod 3 (DAM)

This mini table top tripod is made of all metal construction for extra strength. It includes a metal swivel ball head with lock knob for smooth precision shots. For convenience, the 3-section legs fold for easy storage. It's maximum load is 2.5 lbs., it's minimum height is 5.75", and it's maximum height is 11". It weighs 6 oz .....14.95



### Trailblazer 4-Section Monopod (DAMPT)

Perfect for cameras, scopes and equipment up to 7 lbs., the Trailblazer features 4 sections with quick-snap locks and rubber/retractable spike bottom. Foam handle with strap provides for easy handling. 1/4"-20 camera mounting stud. Maximum height is 68", folded length is 21", weighs 1 lb. Includes soft sided woven tripod bag.....24.95

## HEAVY DUTY TRIPODS

### Pro Lift "A" Tripod (DAA)

Perfect for long-roll portrait and large format cameras, the Pro Lift "A" tripod has a spring-assisted center post that provides quick and easy "floating action" height adjustment. Safety latch automatically locks column in full down position; clamp-type leg locks are freeze resistant and side mounted for fast, easy set-up.

### Airlift Tripod (DAAL)

Perfect for long-roll portrait and large format cameras, the Airlift has a gas cylinder in the center post that provides smooth and easy "floating action" height adjustment. Safety latch automatically locks column in full down position; clamp-type leg locks are freeze-resistant and side mounted for fast and easy set-up.



|              | Maximum Height | Maximum Load | Folded Length | Minimum Height | Weight  | Price  |
|--------------|----------------|--------------|---------------|----------------|---------|--------|
| Pro Lift "A" | 54.5"          | 50 lbs       | 24"           | 25.5"          | 8.8 lbs | 289.50 |
| Airlift      | 54.5"          | 50 lbs       | 24"           | 25.5"          | 9 lbs   | 299.95 |

TRIPODS

437

## PHOTO HEADS



### FGX10 3-Way Fluid Photo/Video Head

- ◆ 3-way tilt plus 360° pan
- ◆ 90° tilt down, 75° tilt up, 90° tilt left
- ◆ Bubble level for accurate leveling
- ◆ Quick release plate with auto closure

### Pro 200S Photo Head

- ◆ Sliding camera screw (1/4"-20).
- ◆ 15° tilt up, 90° tilt down
- ◆ 360° Pan Rotation
- ◆ Platform Size: 6 x 3 1/2"

### Pro 200 Photo Head

- ◆ Sliding camera screw (1/4-20) for optimum camera mounting position.
- ◆ Fits Center Posts: 1 1/8" diameter
- ◆ 15° tilt up, 90° tilt down
- ◆ 360° Pan Rotation
- ◆ 8 3/4 x 7 7/8" Platform Size

### V2 Vernier Head

- ◆ 40° tilt up, 60° tilt plus 360° coarse pan
- ◆ For precision, separate Vernier knobs provide adjustment ( $\pm 7^\circ$ ) of pan and tilt.
- ◆ Sliding camera screws (1/4-20 and 3/8-16) for optimum camera mounting position
- ◆ Platform Size: 6 1/4" x 6 1/2"
- ◆ Fits Center Posts: 1 1/8"

|                     | Max. Camera Supported | Load Capacity | Height | Tripod Mount Thread | Weight    | Price  |
|---------------------|-----------------------|---------------|--------|---------------------|-----------|--------|
| FGX10 (DAFGX10)     |                       | 9 lbs         | 4"     |                     | 2.3 lbs.  | 69.95  |
| Pro 200 (DASH200)   | Large Format          | 35 lbs.       | 4"     | 1 1/8"              | 2.75 lbs. | 99.50  |
| Pro 200S (DASH200S) | 8x10 cameras          | 35 lbs        | 4"     | 1 3/8" or 1 1/8"    | 2.75 lbs. | 74.95  |
| V2 Vernier (DAV2)   | Large Format          | 40 lbs        | 4"     | 1 1/8"              | 5 lbs     | 169.95 |

ORDER & INFO. (212) 502-6340 • FAX: (212) 239-7770 (800) 947-7008  
1-800-290-6750 • www.bhphotovideo.com





# ERGOREST

## MULTI TRIPOD

TRIPODS

438

### Stand and Support

The compact Ergorest Multi-Tripod is a multi-functional camera support that mounts to car windows, serves as a chest pod, shoulder pod, macro stand, flash stand and table tripod. At full height (less head) the Ergorest Multi-Tripod is 6.7" high and weighs only 1.6 lbs. Three camera/head mounting positions are available and the large double thread brass screw fits equipment with either 1/4"-20 or 3/8"-16 tripod sockets. The stainless steel Multi-Tripod is covered with a rugged rubberized material up to 3.8mm thick – to ensure total protection, and for comfortable use in the most extreme environments. Easily adjusted with its angle locking lever, the Multi-Tripod has built-in finger grips to ensure a firm hold, even with gloves!



Multi Tripod (ERMP)  
**\$79.95**



- ◆ Use in a car, on a table, or as a macro stand and repro stand. Clamps easily onto car windows to support cameras, binoculars and spotting scopes.
- ◆ Use as a shoulder and chest support by mounting the camera directly onto the stand with a fastening screw and a tightening knob.
- ◆ A finger pattern provides a firm hold on the stand when using the stand as a chest support. (For example, when photographing nature with a telephoto lens or when used by press photographers with a large zoom lens.)
- ◆ The stand features a holding groove, to support the Multi-Tripod when it is used in a car. It attaches to the car's lowered window edge, with its triangle part leaning on the car door under the window opening. This makes it possible to use even heavy equipment for photographing and filming from a car.
- ◆ Great for macrophotography, as it does the splits in many ways.
- ◆ Comes complete with the Multi Tripod stand, a fastening screw with alternative threaded ends of 1/4" or 3/8", a tightening knob, and an internal thread 3/8"
- ◆ Tilting lever can be screwed off and turned back into its position from the opposite side, making it easy for right- or left-handed people.
- ◆ It also accepts many kinds of lighting equipment, even those requiring electric conductors, in lower, upper and side positions and to bring about various reflected light from desired angles, and also to place flashlight equipment with wireless control.
- ◆ The metal (stainless steel) Multi-Tripod is covered with a rugged rubberized material up to 3.8mm thick – to ensure total protection for the multi-tripod, and for comfortable use in the most extreme environments! Use in cold weather to prevent hands from freezing.
- ◆ Dimensions are 8.78 x 7.08 x 2.9/6.7", and it weighs 29 oz.



For Any Inquiries Regarding Your Order, Call Our Customer Service:  
(800) 221-5743 • (212) 239-7765 • FAX: (800) 947-2215 • (212) 239-7549

### Elliptical and CenterBall Series

The Elliptical Series ballheads are constructed with precision-machined (not cast) aluminum for the ultimate in accuracy and smooth movement. The CenterBall Series are precision machined ball heads that ensure smooth as silk movement and give the center ball incomparable setting accuracy. They feature interchangeable quick-release systems that can handle anything from the smallest digital camera to full-sized 4 x 5" cameras. The camera mounting plates are very flat and small and therefore unobtrusive when mounted on the bottom of the camera. Each ballhead in the series offers extreme vibrational stability to attain the highest level of focus for your photographs. The CenterBall 38mm and 58mm are available with the exclusive "Patented Tilt Function" technology, which converts the center ball into a 2-dimensional tilt mechanism. The ball can then be moved in a precise up and down plane.

#### ELLIPTICAL SERIES

##### Shoe Mount Ballhead (FLBHSM)

For all standard shoe-type flashes or shoe-mounted accessories. Shoe can be removed to allow mounting of 1/4"-20 threaded slaves, dedicated cords, or small cameras. Includes base foot with integral 1/4"-20 hole. It is 2" high, and weighs 1 oz.....**19.95**

##### Compact Ballhead (FLBHC)

For all cameras with 1/4"-20 or 3/8" threads. Includes conversion screw for 1/4"-20 to 3/8". It is 1.25" high, and weighs 3 oz.....**21.95**

##### Standard Ballhead (FLBHS)

For all cameras with 1/4"-20 thread. Base accepts 1/4" or 3/8" threaded tripods or stands. It is 3" high, and weighs 5.8 oz..**29.95**

##### Deluxe Studio Ballhead (FLBHDS)

For all cameras up to 4 x 5" field types. Includes conversion screw for 1/4"-20 to 3/8". It is 3.75" high, has a 1.5" platform diameter, and weighs 10.5 oz.....**54.95**



#### CENTERBALL SERIES



##### CenterBall 38mm

Ball joint construction with panorama base, easy-grip knob and friction control. Camera mounting plate and conversion screw for 1/4"-20 to 3/8". Reversible camera stud: 1/4"-20 and 3/8". Bottom threads: 1/4"-20 and 3/8". It has a height of 3 3/4", a weight of 16 oz., and a maximum load capacity of 22 lbs.

##### Centerball 38 F (FLCB38F):

Includes camera mounting plate and conversion screw for 1/4"-20 to 3/8" ....**149.95**

##### Centerball 38 FPR (FLCB38FPR):

Includes power release system (base and plate) and conversion screw for 1/4"-20 to 3/8" .....**179.95**

##### Centerball 38 FQR (FLCB38FQR):

Includes quick release system (base and quick release plate) and conversion screw for 1/4"-20 to 3/8" .....**269.95**

##### CenterBall 38mm with PTF

Same as the CenterBall 38mm, with the exclusive Patented Tilt Function, which converts the center ball into a 2-dimensional tilt mechanism. The ball can then be moved in a precise up and down plane.

##### Centerball 38 FT (FLCB38FT):

Includes camera mounting plate and conversion screw for 1/4"-20 to 3/8" ....**169.95**

##### Centerball 38 FTQR (FLCB38FTQR):

Includes power release system (base and plate) and conversion screw for 1/4"-20 to 3/8" .....**209.95**

##### Centerball 38 FTQR (FLCB38FTQR):

Includes quick release system (base and quick release plate) and conversion screw for 1/4"-20 to 3/8" .....**299.95**

##### CenterBall 24mm

Camera mounting plate and conversion screw for 1/4"-20 to 3/8". Bottom threads: 1/4"-20 and 3/8". It has a height of 2 1/8" and weighs 5 oz. It's maximum load capacity is 11 lbs.

**CenterBall 24mm (FLCB24):** Ball joint construction with easy-grip knob.....**39.95**

**CenterBall 24mm F (FLCB24F):** Same as above plus friction control.....**69.95**

**DigiBall 24 S (FLDB24S):** Same as above except integral friction built into the lock knob for supersoft ball movement .....**59.95**

##### CenterBall 32mm

Ball joint construction with easy-grip knob and friction control. Reversible camera stud: 1/4"-20 and 3/8". Bottom threads: 1/4"-20 and 3/8". It has a 3 1/8" height, a weight of 10 oz. and a 16.5 lb. maximum load capacity.

**CenterBall 32mm F (FLCB32F):** Includes camera mounting plate and conversion screw for 1/4"-20 to 3/8" .....**79.95**

**Centerball 32 FPR (FLCB32FPR):** Includes power release system and conversion screw for 1/4"-20 to 3/8" .....**119.95**

# FLM

## BALLHEADS

TRIPODS

440

### CenterBall 58mm

Ball joint construction with panorama base, easy-grip knob, friction control and Patented Tilt Function (PTF). Reversible camera stud: 1/4"-20 and 3/8". Bottom threads: 1/4"-20 and 3/8". It is 5 5/8" high, weighs 28 oz., and has a maximum load capacity of 33 lbs.



#### Centerball 58 FT (FLCB58FT):

Includes camera mounting plate and conversion screw for 1/4"-20 to 3/8" .....229.95

#### Centerball 58 FTQR (FLCB58FTQR):

Includes quick release system (base and quick release plate) and conversion screw for 1/4"-20 to 3/8" .....349.95

### Power Release System

Get a firm and quick connection between the camera and the ballhead eliminating vibration. The knurled grip with its reduced-ratio threads produces a tight bond between the camera and the plate.

**Power Release System (FLPR)** Includes Power Release Base and Plate...49.95

**Power Release Plate (FLPRP)** .....14.95    **Power Release Base (FLPRB)** ....44.95



Power Release Plate

### Quick Release System

Quick clamping base and integrated plate locking device create a fail-safe system to handle even the heaviest cameras. The base connection is 3/8"; the plate connection has 1 1/2 + 2 1/4" screws. The base weighs 4.6 oz., the plate weighs 2.3 oz.

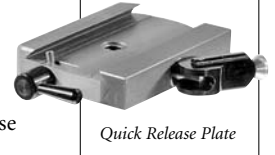

Quick Release Plate

**Quick Release System (FLQR)** Includes Quick Release Base and Plate.....142.95

**Quick Release Plate (FLQRP)** .....49.95

**Small Quick Release Plate (FLQRPS)** .....29.50

**Quick Release Base (FLQRB)** .....119.95

## ACCESSORIES

**Camera Platform for CenterBall Series (FLCP):** Fits CenterBall heads. Replacement .....9.95

**Conversion Screw - 1/4"-20 to 3/8" (FLCS):** Converts female 3/8" to 1/4"-20 and male 1/4"-20 to 3/8". Fits on 1/4"-20 camera mount screws and converts them to 3/8" .....1.95

**Reversible Camera Stud 1/4"-20 to 3/8" (FLST)** .....6.95

# FOBA

**Superball Ballhead:** Made with the precision of Sinar and the reliability of Foba, the Superball has large locking levers that make the head very easy to handle. It locks down firmly with just a twist. In fact, the Superball has one of the strongest locks on the market today. Once the ball is locked it stays locked. But that's not to say you can't adjust the friction on the ball to suit your needs. Besides this, the base can rotate a full 360° and its tension is adjustable. User-adjustable tension allows fine-tuning the performance of the ball to suit the shooting situation, as well as to compensate for wear over the life of the ball, which sits in a Teflon collar for smooth rotation.

**Mini-Superball Ballhead:** Foba's Mini-Superball puts the advanced features of the popular Superball into a very compact, lightweight package. Compact size and 15 lb. capacity are ideal for small and medium format cameras in the studio or in the field.

**Superball M-1:** Designed specifically for 35mm and medium format cameras, the M-Line Ballhead is available in two versions; the Superball M-1 which includes a camera plate with a 1/4" thread, and the Superball M-1 with quick release head. The M-Line is compatible with all of the existing Quick Release Plates found in the Superball line. The M-Line Superball features a rotating base for easy positioning and is ergonomically designed, making it easy to handle for both amateurs and professionals. Its one-knob-locks-all process ensures simple and rapid operation.



Continued on the next page...



www.bhphotovideo.com

# FOBA

## BALLHEADS

TRIPODS

441

### SUPERBALL

#### Superball with 1/4"-20 and 3/8"-16 Standard Head (FOSB)

Can be used on all types of tripods and studio stands. Can be reversed for 1/4" or 3/8" threads. Maximum load capacity 32 lbs. with a base diameter of 3". Height is 5" and it weighs 2.6 lbs.....439.95

#### Superball with Quick Release Head (FOSBQR)

Same features as above except with a quick release plate that allows you to change cameras quickly and easily with the twist of just one knob. Head includes a removable safety stopper. Requires plate. There are six types of quick release plates to choose from including: 3/8", 1/4", 35mm and Hasselblad 3/8" and 1/4" .....449.95



### MINI SUPERBALL

#### Mini-Superball with 1/4"-20 and 3/8"-16 Standard Head (FOSBM)

Compact, without panning capabilities. Maximum load capacity 15 lbs. with a base diameter of 2.5". It's height is 3.9" and it weighs 20 oz.....234.95

#### Mini-Superball with Quick Release Head (FOSBMQR)

Same features as above except with a quick release head that allows you to change cameras quickly and easily with the twist of just one knob. Head includes a removable safety stopper. Requires plate. There are six types of quick release plates to choose from including: 3/8", 1/4", 35mm and Hasselblad 3/8" and 1/4" .....269.95



#### Mini-Superball Plus with Standard Head (FOSBMP)

Same as Mini-Superball except it is equipped with a separate calibrated panning base, which can be locked and unlocked independently of the ball itself.....336.50

#### Mini-Superball Plus with Quick Release Clamp (FOSBMPQR)

Same as above, it requires the additional purchase of an Arca-type quick release plate, made by a host of manufacturers including Acra-tech, Arca-Swiss, Foba, Novoflex and Wimberley .....364.95

### SUPERBALL M-1

**Superball M-1 with 1/4" Thread Camera Plate (FOSBM114):** Rotating base for easy positioning. Multi-function locking system, high clamping force (10 lbs), full 360° rotation. 18 lb. maximum load capacity, it's height is 3.5" and it weighs 10 oz.....156.95



**Superball M-1 with Quick Release Head (FOSBM1QR):** Same as above except with a quick release head that allows you to change cameras quickly and easily. Compatible with all current Superball plates. It's height is 4.5", and it weighs 14 oz.....199.50

### ACCESSORIES

**Universal Plate for Superball (FOUPSB):** Has 1/4" and 3/8" threads. Supplied with standard head .....54.00

**Universal Plate for Mini-Superball (FOUPMSB):** Has 1/4" and 3/8" threads. Supplied with standard head .....54.00

**Quick Release Head for Superball (FOQRHSB):** An Arca-style quick release head. Requires plate.....119.95

**Panorama Base for Mini-Superball (FOPB):** Provides 360° calibrated panning.....152.50

**Quick Release Head for Mini-Superball (FOQRHMSB):** An quick release adapter. Requires plate.....87.50

**Base Plate for Superball (FOBP):** With 3/8" screw. Attaches to the bottom of the Superball, allowing it to be used from a very low level or tabletop.....146.95

**Quick Release Plate (FOQRP35):** With 1/4" screw for 35mm cameras.....54.00

ORDER & INFO. (212) 502-6340 • FAX: (212) 239-7770 (800) 947-7008  
1-800-290-6750 • www.bhphotovideo.com



# GIOTTOS

## MINI TRIPODS

TRIPODS

442

### U.Pod

The U.Pod series was developed after a great deal of consultation with end users and professionals.

Constructed of an aluminum alloy, protected by a wear-proof black laquer, they are available with built-in pan or ball head. The legs



fold into the central column for storage or use as a mini-monopod (pistol grip). Unfolded the legs become a platform turning the U.Pod into a stable mini tripod supporting up to 7 lbs. They fold to 9.65" and extend to 14.4". A wrist strap is built-in for added convenience.

- U.Pod with Pan Head (GICTTPH) .....33.00
- U.Pod with Ball Head (GICTTBH) .....29.95

### P.Pod



If you think it's just a monopod, then look again. Made of solid aluminum alloy, the monopod feels solid and sturdy. Its surfaces are carefully polished twice to give its leg sections smooth and firm locking and quick unlocking action. Finally, it is anodized, preserving the distinctive look of aluminum and pure black finish. Now take it into the field.

Its three accessory feet can be deployed at the foot of the monopod, turning it into a tripod. Plus, it's height is adjustable from

23.6" to 72.6". Alternatively, the accessory feet can be fixed to its collar to turn the monopod into a low height tripod. Finally, fixing two of the feet around the neck of the monopod gives you a low angle tripod ideal for macro and nature photography.

Integral quick release pan head allows the camera to be instantly attached and detached. The 2-way tilt head allows 180° of movement.

- P.Pod (GIPP) .....69.95

### Q.Pod & Ball.Pod

Unbelievably small yet extraordinarily strong pocket tripods for cameras, telescopes, binoculars and camcorders. Although they are the smallest tripods in the world, the Q.Pods (tilt head) and Ball.Pods (ball head) are multi-functional, strong and the best choice when traveling. Titanium finish with rubber tipped legs they stand steady on any surface and are suitable for any occasion. Available in a two or five-section leg design, each has a minimum height of 3", extended height of 4.25", weighs 3.7 oz. and includes a case.

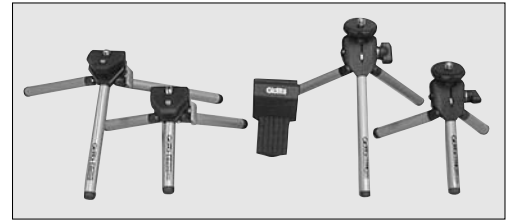

#### Compact Q.Pod (GICQPT)

- 2-section rubber tipped legs
- Tilt head with 1/4-20 thread and video pin
- Folds flat (folded size 5 x 1.5 x 0.9") ....16.95

#### Mini Q.Pod (GIMQPT)

- 5-section rubber tipped legs
- Tilt head with 1/4-20 thread and video pin
- Folds flat (folded size 3.5 x 1.5 x 0.9") ..21.95

#### Compact Ball.Pod (GICBPT)

- 2-section rubber tipped legs
- Ball head with 1/4-20 thread and video pin
- Folds flat (folded size 5 x 1.5 x 0.9") ....14.95

#### Mini Ball.Pod (GIMBPT)

- 5-section rubber tipped legs
- Ball head with 1/4-20 thread and video pin
- Folds flat (folded size 3.5 x 1.5 x 0.9") ..18.95

## PHOTO TRIPODS

### VT-800 Series



The VT-800 Series delivers exceptionally smooth geared center column movement with a crank and easy-locking knob. The 3-way pan head lets you mount and remove the camera by simply pushing the quick release lever. A bubble level helps you adjust horizontal position quickly and easily. Easy-to-lock and release leg locks. They all have a built-in handle, and a hook that allows you to hang weight for greater stability.

**VT-806 (GIVT806):** With an air cushioned geared column, the VT-806 has a 60" maximum height, a 24" closed length, and weighs 2.4 lbs.....38.95

**VT-808 (GIVT808):** Maximum height 60", closed length 24", it weighs 2.9 lbs .....49.95

**VT-809 (GIVT809):** Maximum height 65", closed length 27", it weighs 3.9 lbs .....59.95



### IY Series

The IY-332 and IY-442 offer unique styling, functions, and strong aluminum alloy legs. They feature a multi-joint extension handle that can be set face forward or backwards; a quick release platform that flips up automatically when the quick lever lock is pushed for secure locking and easy on/off operation. They include a 3-way pan head that is self-adjusting with the camera platform, adjustable to any angle up to 90°. There is an air-cushioned center column with crank as well as center column lock carrying handle. With adjustable locking center brace lock, the angle of the legs are also adjustable. They also have adjustable rubber ball feet.

**IY-332 (GIY332):** Maximum height 58", closed length 24", it weighs 3.2 lbs.....44.95

**IY-442 (GIY442):** Maximum height 52", closed length 22", it weighs 2.3 lbs.....34.95



For Any Inquiries Regarding Your Order, Call Our Customer Service:  
(800) 221-5743 • (212) 239-7765 • FAX: (800) 947-2215 • (212) 239-7549

# GIOTTOS

## BALL HEADS

### MH-1004 (GIMH1004)

The smallest ball head with single knob for the ball and the pan. Weighs 4.8 oz., 2.4" height, capacity 5 lbs. Top plate with 1/4" camera thread. Base with 3/8" tripod socket with 1/4" reducing bushing .....**8.95**

### MH-1003 (GIMH1003)

Small ball head with single knob for the ball and the pan. Weighs 5.3 oz., 2.8" height, 8.8 lb capacity. Top plate with 1/4" camera thread. Base with 3/8" tripod socket with 1/4" reducing bushing.....**39.00**



### MH-1002 (GIMH1002)

Compact ball head with ball lock knobs and pan lock. Weighs 8.4 oz., 3" height, 13 lb capacity. Top plate with 1/4" camera thread. Base with 3/8" tripod socket & 1/4" reducing bushing. Includes draw string pouch .....**59.95**

### MH-1001 (GIMH1001)

Medium ball head with calibrated tension and lock knobs and pan lock. Weighs 13 oz., 4" height, 17.6 lb. capacity. Top plate with 1/4 and 3/8" camera threads. Base with 3/8" tripod socket with 1/4" reducing bushing. Includes draw string pouch .....**89.95**

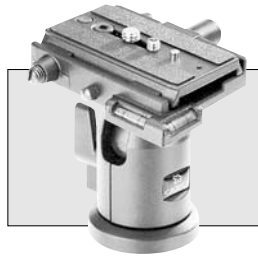

### MH-7001 (GIM7001)

Ball head with built-in quick release supports 13 lbs. Camera plate slide to aid in macro camera positioning. QR has two bubble levels and is equipped with 1/4 and 3/8" camera screws. Weighs 21 oz. and is 4.3" high. Base with 3/8" tripod socket with 1/4" reducing bushing. Includes draw string pouch...**54.95**

### MH-1000 (GIMH1000)

Large ball head with calibrated tension and lock knobs and pan lock. Weight 20.6 oz., 4.5" height, 22 lb. capacity. Top plate with 1/4 and 3/8" camera threads. Base with 3/8" tripod socket with 1/4" reducing bushing. Includes draw string pouch .....**109.95**

### MH-2000 (GIMH2000)

Large ball head with dual ball design. Calibrated tension and lock knobs. Weighs 23.5 oz., 5.4" height, 26.5 lb. capacity. Top with 1/4 and 3/8" camera threads. Base with 3/8" tripod socket with 1/4" reducing bushing. Includes draw string pouch .....**149.95**

### MH-3000 (GIMH3000)

The largest Giottos ball head. Calibrated tension pan and lock knobs. Weighs 42 oz., 5.4" height, 33 lb. capacity. Top with 1/4 & 3/8" camera threads. Base with 3/8" tripod socket with 1/4" reducing bushing. Includes draw string pouch.....**119.95**



### 3-Way Pan Heads

3-way pan head with lever lock, 1/4" thread, bubble level, padded handles, 3/8" tripod socket with reducing bushing. Weighs 1.3 lbs., supports 18 lbs. Includes pouch case. (GIPH) .....**37.95**

3-way pan head with double locking quick release and 1/4" thread, two bubble levels, padded handles, 3/8" tripod socket with bushing. Weighs 1.5 lbs., supports 18 lbs. Includes pouch case. (GIPHQR) .....**43.00**

### Quick Release Adapters with Plate

For MH-1000, MH-1001, MH-2000, MH-3000, and M-7001 Ball Heads.

MH 100 (GIMH100): With 1/4" thread. Camera plate release via lever.....**24.95**

MH 200 (GIMH200): With 1/4" and 3/8" thread. Camera plate release via screw .....**34.95**

MH 500 (GIMH500): With 1/4" and 3/8" thread. Camera plate release via screw .....**42.95**

MH 621 (GIM621): With 1/4" and 3/8" thread. Plate slides for macro positioning.....**29.95**

MH 652 (GIM652): With 1/4" and 3/8" thread. Fits most ballheads.....**24.95**

TRIPODS

443



# GIOTTOS

## UNIVERSAL SERIES

TRIPODS

444

### *The Universal Tripod*

Setting the standard for features and design in a professional quality tripod, the Universal Series have a very unique style, are very versatile, but yet very economical. The unique centercolumn can be used as a lateral arm with angle adjustment, especially ideal for nature and micro photography. The column can also be used upside down. It allows 360° horizontal and 180° vertical adjustment, and the column can be positioned and set quickly with the locking knob. The Universal Series is available with carbon fiber or aluminum legs and center column, both types are available in three models that differ only in the number of leg sections, maximum height and leg diameter.

#### FEATURES

- ◆ Legs and center-column are made of durable aluminum or French-made high-strength carbon fiber tubing used in aerospace engineering to yield exceptional stability for its weight. Carbon fiber is shock and vibration absorbent, but still relatively lightweight. The carbon fiber used for these legs is made from twelve layers, and the spiral grain is visible on the surface, giving it its high-tech look.
- ◆ When mounting plate is used without column it becomes a 3-way pan tilt head.
- ◆ Remove the center column from the platform by loosening the set screw to use the top-plate as a 3-way pan/tilt head.
- ◆ You can set the camera directly with no need for an extra head on it for the lowest shooting position, when using the built-in universal 3-way pan head. Just separate the center column from the platform and lock the safety knob. It provides 360° horizontal and 180° vertical adjustment, quickly and easily.

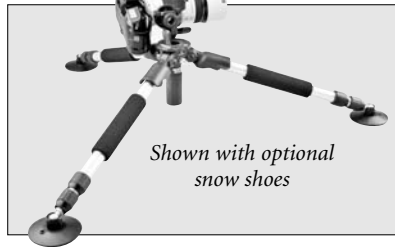
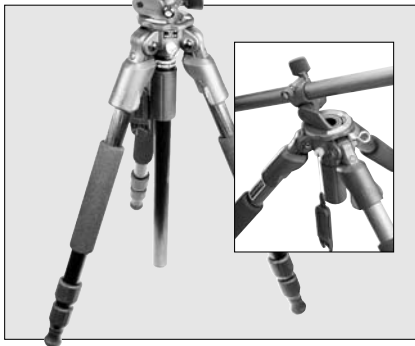

- ◆ Convenient leg spread adjustment with calibrated collar with settings for 25, 50 and 75° leg spread. The 3-position release control allows the legs to be released to any of three pre-set angles. Alternatively each leg can be released with the powerful leg lock and positioned at will.
- ◆ Reversible center column with retractable hook for hanging a weight. The retractable hook can be used to add stability with a sand bag or equipment bag.
- ◆ Special tilt control on column allows column to be used at any angle from the tripod legs.
- ◆ Mounting plate for head can be removed from center column for low-level work (minimum height 9.8").
- ◆ Three set screws under mounting plate eliminate twisting of head.
- ◆ Dual spring-loaded head mounting screw with both 3/8 and 1/4" thread.
- ◆ The Universal tripods are available with 3- or 4-section legs. The shortest version has a 28mm leg tube and a maximum height of 63". The 3-section with 32mm diameter leg tube opens to 67" and the 4-section with 32mm leg tube opens to 71".



- ◆ All models support up to 33 lbs.
- ◆ Built-in spirit level
- ◆ Legs have a thick foam padding to ensure a firm grip and for comfort in extreme temperatures.
- ◆ Universal rubber ball feet (with spike inside) can be removed to convert to metal spike or optional snow shoes. Spikes assure firm contact on wet soil, gravel, or rocky areas.

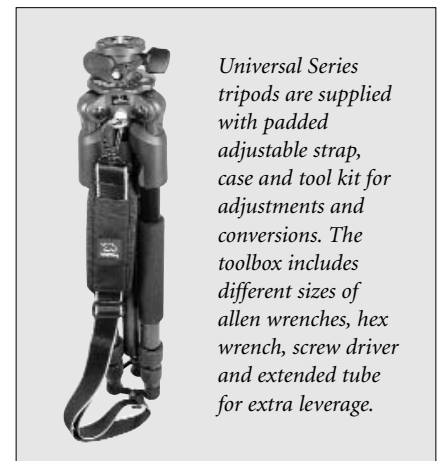

**EQUIPMENT LEASING AVAILABLE**

# GIOTTOS

## UNIVERSAL SERIES

TRIPODS

445

### GIOTTOS TRIPOD SPECIFICATIONS

| Tripod                 | MT-8160             | MT-8170             | MT-8180             | MT-9160             | MT-9170             | MT-9180             |
|------------------------|---------------------|---------------------|---------------------|---------------------|---------------------|---------------------|
| Maximum Height         | 63"                 | 67"                 | 71"                 | 63"                 | 67"                 | 71"                 |
| Minimum Height         | 9.75"               | 9.75"               | 9.75"               | 9.75"               | 9.75"               | 9.75"               |
| Folded Length          | 23.5"               | 25"                 | 23.3"               | 23.5"               | 25"                 | 23.3"               |
| Load Capacity          | ± 33 lb             | ± 33 lb             | ± 33 lb             | ± 33 lb             | ± 33 lb             | ± 33 lb             |
| Leg Sections           | 3                   | 3                   | 4                   | 3                   | 3                   | 4                   |
| Leg Lock Type          | Twist-lock          | Twist-lock          | Twist-lock          | Twist-lock          | Twist-lock          | Twist-lock          |
| Independent Leg Spread | Yes                 | Yes                 | Yes                 | Yes                 | Yes                 | Yes                 |
| Center Column Sections | 1                   | 1                   | 1                   | 1                   | 1                   | 1                   |
| Center Column Type     | Rapid sliding       | Rapid sliding       | Rapid sliding       | Rapid sliding       | Rapid sliding       | Rapid sliding       |
| Center Brace           | No                  | No                  | No                  | No                  | No                  | No                  |
| Spiked Feet            | Yes                 | Yes                 | Yes                 | Yes                 | Yes                 | Yes                 |
| Head Mount Thread Size | Dual 1/4-20" & 3/8" | Dual 1/4-20" & 3/8" | Dual 1/4-20" & 3/8" | Dual 1/4-20" & 3/8" | Dual 1/4-20" & 3/8" | Dual 1/4-20" & 3/8" |
| Weight                 | 5.5 lb              | 5.7 lb              | 5.7 lb              | 6.2 lb              | 6.6 lb              | 6.6 lb              |
| Item Code              | GIMT8160            | GIMT8170            | GIMT8180            | GIMT9160            | GIMT9170            | GIMT9180            |
| Price                  | 259.95              | 284.95              | 309.95              | 136.95              | 144.95              | 154.95              |

## MONOPODS

Monopods are specially designed for photographers on the move, for all styles of photography such as fashion or sports. With a monopod you can support heavy cameras, make instant changes to angle and position in restricted spaces to capture the perfect shot. Available in 3-, 4- and 5-section models, in aluminum or carbon fiber, all Giotto's monopods feature foam-padded grip, rubber-covered leg locks, spring-loaded 3/8" and 1/4" camera screw, and a rubber ball foot that accepts accessory spikes or shoes. The rubber foot gives them firm ground support and flexibility of up to 360° of tilt. Carbon fiber models also feature a spring-loaded foot pedal for added support, and all monopods are equipped with an adjustable wrist strap, case and toolkit.



### GIOTTOS MONOPOD SPECIFICATIONS

|                 | 409140   | MM-9160  | MM-9170  | MM-9180  | MM-8950      | MM-8970      | MM-8990      |
|-----------------|----------|----------|----------|----------|--------------|--------------|--------------|
| Type            | Aluminum | Aluminum | Aluminum | Aluminum | Carbon Fiber | Carbon Fiber | Carbon Fiber |
| Load Capacity   | 33 lbs.  | 33 lbs.  | 33 lbs.  | 33 lbs.  | 33 lbs.      | 33 lbs.      | 33 lbs.      |
| Extended Length | 60"      | 62"      | 66.5"    | 70.5"    | 59"          | 70"          | 75"          |
| Folded Length   | 20.2"    | 19"      | 22.3"    | 20.6"    | 24.3"        | 26.9"        | 24.7"        |
| Leg Sections    | 4        | 5        | 4        | 5        | 3            | 3            | 4            |
| Leg Diameter    | 32mm     | 32mm     | 36mm     | 36mm     | 28mm         | 32mm         | 32mm         |
| Weight          | 1.3 lbs. | 1.3 lbs. | 1.7 lbs. | 1.6 lbs. | 1.3 lbs.     | 1.3 lbs.     | 1.6 lbs.     |
| Item Code       | GIMP460  | GIMP5    | GIMP466  | GIMP570  | GIMPCF359    | GIMPCF370    | GIMPCF4      |
| Price           | 49.95    | 52.95    | 55.00    | 58.95    | 98.00        | 113.00       | 128.00       |

ORDER & INFO. (212) 502-6340 • FAX: (212) 239-7770 (800) 947-7008  
**1-800-290-6750 • www.bhphotovideo.com**



# GITZO

## SUPPORT SYSTEMS

TRIPODS

446

Gitzo tripods, monopods, heads and accessories are acknowledged by professionals the world over as setting the industry's standards for excellence. The classic Gitzo style, combined with today's space-age materials and modern ergonomic designs keeps Gitzo at the forefront of camera support system design. No gimmicks and no compromise on quality. High strength lightweight aluminum alloy, carbon fiber tubes and magnesium alloys ensure absolute stability and effectiveness. In addition, fine tolerance in the assembly and smooth control, ensure that Gitzo tripods and heads are engineered to withstand the most vigorous handling. Gitzo products are versatile and timeless. A Gitzo tripod purchased over 30 years ago still remains compatible with accessories available today and with Gitzo's tried and true design, yesterday's tripod can be serviced today!



Gitzo carbon fiber and light aluminum alloy tripods are designed for every application in the studio on location. Each tripod has been designed especially to withstand a specified maximum weight of equipment, which is assessed as being placed above the center of gravity of a fully extended tripod. There are also two styles of tripods—Standard or Performance. Standard style tripods have one fixed leg angle spread to ensure the center column is always vertical at a given leg extension and are rock solid. Performance styles are fitted with sliding stops, which enable the legs to be individually set at different angles.

**Classic:** Used by professionals around the world, Classic aluminum tripods are individually hand assembled with painstaking care using the finest high strength alloys, providing uncompromising support.

**Basalt:** The innovative minds of Gitzo design engineers have brought forth the world's first basalt tripod range. Basalt is as tough as aluminum but much lighter, is better at absorbing vibrations and is also recyclable. Lightweight and incredibly strong, all models are individually hand-assembled so there's absolutely no compromise in quality.

| Series      | Series Reference | Leg Tube Size |
|-------------|------------------|---------------|
| Table       | 00               | 16mm (5/8")   |
| Weekend     | 0                | 20mm (3/4")   |
| Sport       | 1                | 24mm (7/8")   |
| Reporter    | 2                | 28mm (1 1/8") |
| Studex      | 3                | 32mm (1 1/4") |
| Pro Studex  | 4                | 37mm (1 1/2") |
| Tele Studex | 5                | 41mm (1 5/8") |



Gitzo Series numbers are defined by the diameter of the top leg section. This measurement also determines the Series height range, load capacity and, to an extent, suitable product application.

**Mountaineer:** The original carbon fiber tripods, the Mountaineers offer the most extensive range. 30% lighter than traditional aluminum tripods, while retaining strength and torsional rigidity - the strongest in their class.

**Leveling:** The revolutionary Gitzo Leveling tripods have a ball joint mounted center column designed to let you get your camera perfectly level simply by adjusting column inclination instead of having to set each leg individually. The rougher the terrain, the more you'll notice how much the Leveling mechanism helps you get shooting quickly and accurately.

**Explorer:** The most versatile tripods in the Gitzo range, Explorer is ideal for photographers working in the field. They will hold your camera steady in places you might never have thought of and let you capture pictures previously beyond your horizons.

**Systematic:** The Systematic range is the choice of the professional; it lets you construct a tripod to suit your needs. Choose your tripod legs and add a rapid or geared center column, bowl interface, levelling base or flat plate depending on your application. Some models allow interchangeable feet to anchor your tripod on any surface.



EQUIPMENT LEASING AVAILABLE

## G1155T 'TRAVELER'

### Sport Carbon Performance Tripod

It's been a long time since a truly innovative tripod has come to market. With the introduction of the G1155T, or Traveler Gitzo has introduced a whole new concept to the world of tripods. Designed for users who want to take a very lightweight full size tripod with them when they travel, this tripod will accommodate digital and compact cameras as well as lightweight camcorders. Due to its unique design, the Traveler doesn't compete with any other tripod on the market.

The Traveler is the most compact carbon fiber tripod in the world. When opened, it is as tall a standard Gitzo tripod, but thanks to its ground-breaking 180° folding mechanism, it is 25% shorter than standard when folded. Available in Series 1 models, the Traveler fits perfectly in hand luggage and is ideal for photographers on the move.



TRIPODS

447

### FEATURES

- ◆ Lightweight and compact 5-section tripod with grooved rapid column, designed to fit into hand luggage
- ◆ Unique 180° folding legs allows the 2.2 lbs tripod to fold down to 14.2" yet expand to 57.5" when fully extended
- ◆ Made of Carbon 2, an all new six-layer tube construction process makes it stronger than existing carbon, yet 15% lighter. Also provides greater capacity to absorb vibrations and withstand fatigue.
- ◆ The legs are assembled using Gitzo's "H.I.S.," a dual "screw thread and glue" jointing technology that provides greater durability and reliability than alternative methods
- ◆ Has a new center column-locking collar found above the tripod. Adjusting the collar is fast and easy and it also improves stability.
- ◆ It only takes seconds to open and secure the tripod with the new Anti-Leg-Rotation (ALR) system. Just loosen all twist locks at the same time and pull down the leg before tightening the twist locks, making setup a mere 15 seconds.
- ◆ Polymer Bushings can be used in river beds all day long without adverse effect on locking mechanism
- ◆ Stabilizing hooks that use to take up space and snag on clothing or equipment are no longer a problem. A redesigned built-in, spring-loaded, retractable accessory hook provides a place to hang equipment, such as camera, sand or water bags, on the bottom of the center column.
- ◆ Includes G1077M Magnesium center ball head, so no additional expense for a head is necessary. When closed, the head is protected under folded legs.
- ◆ The Traveler also is built with Gitzo's anti-rotation grooved center column. The center column-locking collar makes it easier to adjust the column quickly.

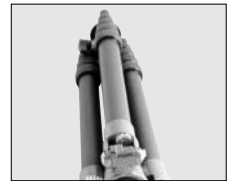

### G1155T Traveler Tripod (GIG1155T)

A five-section tripod that weighs just 2.2 lbs., folds down to 14.2", and provides support from 13.8" up to 57.5" .....593.95

## MOUNTAINEER SERIES

### Carbon Fiber Tripods

Mountaineer carbon tripods are up to 30% lighter than equivalent alloy tripods without any compromise on strength, stability or durability. The exclusive manufacturing process ensures stiff, light tubes that are resistant to bending and stable in extreme temperatures. The grooved carbon rapid center columns prevent rotation, increase stability and include a stainless steel weight hook. All Mountaineer tripods are fitted with sliding stops, which enable legs to be set at different angles.

- ◆ Gitzo carbon tubes use an exclusive process based on pull winding of long carbon fibers which are precisely wrapped and combined under high pressure and temperature with epoxy resin to a 1.5mm wall thickness.
- ◆ This manufacturing process ensures stiff, light tubes resistant to bending, with superior tensile and compression strength, and a high degree of stability in extreme temperatures.
- ◆ Tripods are constructed using a “screw thread and glue” dual jointing “H.I.S.” (Hybrid Interconnection System) technology pioneered by Gitzo. Provides greater strength and security on location.
- ◆ They provide strength, and a high degree of stability in extreme temperatures. The tubes also absorb vibration and withstand fatigue better than those made by other carbon fiber tube processes.
- ◆ Telescopic leg extensions and center columns are fitted with anti-slipage rubber cushioned locking rings and “wingnut” locks.
- ◆ All except the G0027 are “Performance” models fitted with sliding stops that allow the legs to be set at different angles.
- ◆ Built-in hook on Sport, Reporter and Studex series let you hang a stabilizing weight (like a camera bag) on the bottom of the tripod. Ideal with long lenses, on uneven ground or in windy conditions.
- ◆ On rapid center column tripods, the center column locking collar above the tripod shoulder makes it easier to adjust the column quickly. The rapid column can also easily be inverted for an alternative shooting angle or low level macro work.
- ◆ Sport, Reporter and Studex series tripods are fitted with a grooved center column to prevent rotation and increase stability.
- ◆ On geared models, the gear mechanism allows you to precisely adjust the height of the column. An anti-rollback system keeps heavy equipment safely supported, and can be disengaged by pressing the secondary lever while winding down.

#### G0027 (GIG0027) Ultra Compact Carbon Fiber Tripod

The smallest of the carbon fiber series, the G0027 Ultra Compact tripod is packed with features. It weighs less than 1 lb., but will comfortably support loads up to 5.5 lbs. - ideal for compact digital and film cameras. It features a silky-smooth rapid center column as well as Gitzo’s unique dual jointing H.I.S. technology. This construction technique provides greater strength and stability. It offers rigidity for low-angle shooting, and is extremely portable. It’s 11.8” folded length means it will fit into almost any accessory bag or briefcase.



#### Mountaineer Weekend Tripods

Just when you thought traveling with a tripod was too cumbersome and bulky, Gitzo does it again. Built for travel photography, and designed for either digital or film cameras, the 3-section G1027 and 4-section G1028 Mountaineer Weekend tripods combine portability, stability, lightness, and feature a high maximum load capacity at a very low weight.

**G1027 (GIG1027)  
Performance Tripod**  
With a closed length of 16.5” and weighing just 1.7 lbs, it makes packing much easier. When in the open position, the G1027 will comfortably support camera loads up to 6.6 lbs, while providing 47.6” of maximum height (with center column extended).

**G1028 (GIG1028)  
Performance Tripod**  
Virtually identical to the G1027, the G1028 offers more height than the G1027. It can comfortably support camera loads up to 6.6 lbs, while delivering a maximum height of 54.3” (with the center column extended).

|       | Style       | Column type | Leg sections | Max. height with extended center column | Max. height column down | Min. height | Closed height | Weight   | Max. Load Capacity | Price  |
|-------|-------------|-------------|--------------|---|-------------------------|-------------|---------------|----------|--------------------|--------|
| G0027 | Standard    | Rapid       | 3            | 28.3”                                   | 20.8”                   | 10.6”       | 11.8”         | 0.97 lbs | 5.5 lbs            | 309.95 |
| G1027 | Performance | Rapid       | 3            | 47.6”                                   | 37”                     | 16.5”       | 17.7”         | 1.7 lbs  | 6.6 lbs            | 324.95 |
| G1028 | Performance | Rapid       | 4            | 54.3”                                   | 43.3”                   | 16.1”       | 17.7”         | 1.7 lbs  | 6.6 lbs            | 384.95 |

## MOUNTAINEER SERIES

### Mountaineer Sport Tripods

Mountaineer Sport tripods set the standard for lightweight tripods, offering a high maximum load together with a very low weight. Traveling with a tripod has never been so easy. They hold up to 10 lbs. yet weigh only 3 lbs. Their size, weight and stability puts them in a class of their own. Models that end with a "G" are part of a new geared tripod series that combine the strength and stability of the Mountaineer range with the precision height adjustment of an aluminum geared column.

**G1127 Performance Tripod** (GIG1127)

A three-section tripod that weighs just 2.7 lbs., folds down to 23.2", and provides support from 12.6" up to 59.4".

**G1127G Geared Tripod** (GIG1127G)

Same as above with geared column.

**G1128 Performance Tripod** (GIG1128)

A four section tripod that weighs just 2.6 lbs., folds down to 18.5" and provides support from 12.2" up to 46.1".

**G1128G Geared Tripod** (GIG1128G)

Same as above with geared column.

### Mountaineer Reporter Tripods

Suitable for both SLR, medium format and light 6 x 6 cameras, these tripods feature a grooved rapid center column and have legs that can be set individually at 24°, 55° and 90°. They each have a maximum load capacity of 17½ lbs., and weigh 3¼ lbs. These tripods are also available in a geared version that combines the strength and stability of the Mountaineer range with the precision height adjustment of an aluminum geared column.

**G1227 Mountaineer Tripod** (GIG1227)

3 leg sections. With robust stability that makes it perfect for location or studio work. It has a maximum height of 63.4" and a minimum height of 13.4".

**G1227G Geared Tripod** (GIG1227G)

Same as above with geared column.

**G1228 Mountaineer Tripod** (GIG1228)

4 leg sections, ideal for outdoor nature/backpacker photographers. It has a 60.6" maximum height and a 12.6" minimum height.

**G1228G Geared Tripod** (GIG1228G)

Same as above with geared column.

### G1327 Mountaineer Studex Tripod

 (GIG1327)

For photographers who will settle for nothing less than a Studex Carbon Fiber Tripod, but require the extra stability for heavy loads. The 3-section G1327 combines portability, stability, and lightness, and supports up to 26 lb. maximum load while weighing only 5 lbs. Professional tripod for all 35mm SLR, and medium format cameras with heavier lenses.



TRIPODS

449

|        | Style       | Column type | Leg sections | Max. height with extended center column | Max. height column down | Min. height | Closed height | Weight  | Max. Load Capacity | Price  |
|--------|-------------|-------------|--------------|---|-------------------------|-------------|---------------|---------|--------------------|--------|
| G1127  | Performance | Rapid       | 3            | 59.4"                                   | 50.8"                   | 12.6"       | 23.2"         | 2.7 lbs | 9.9 lbs            | 414.95 |
| G1127G | Performance | Geared      | 3            | 55.1"                                   | 48.8"                   | 11.4"       | 22"           | 3.1 lbs | 9.9 lbs            | 449.95 |
| G1128  | Performance | Rapid       | 4            | 54.7"                                   | 46.1"                   | 12.2"       | 18.5"         | 2.6 lbs | 9.9 lbs            | 467.95 |
| G1128G | Performance | Geared      | 4            | 50"                                     | 43.7"                   | 11.4"       | 17.3"         | 3 lbs   | 9.9 lbs            | 514.95 |
| G1227  | Performance | Rapid       | 3            | 63.4"                                   | 54.7"                   | 13.4"       | 25.6"         | 3.4 lbs | 17.6 lbs           | 464.95 |
| G1227G | Performance | Geared      | 3            | 65"                                     | 53.5"                   | 17.3"       | 24.4"         | 4.4 lbs | 17.6 lbs           | 538.95 |
| G1228  | Performance | Rapid       | 4            | 60.6"                                   | 52"                     | 12.6"       | 21.3"         | 3.4 lbs | 17.6 lbs           | 509.95 |
| G1228G | Performance | Geared      | 4            | 63.4"                                   | 52"                     | 17.3"       | 20.1"         | 4.4 lbs | 17.6 lbs           | 579.95 |
| G1327  | Performance | Rapid       | 3            | 70.7"                                   | 59.8"                   | 17.3"       | 28"           | 5.1 lbs | 26.5 lbs           | 569.95 |



# GITZO

## LEVELING TRIPODS

TRIPODS

450

The revolutionary Gitzo leveling tripods have a ball joint-mounted center column designed to let you get your camera perfectly level simply by adjusting column inclination instead of having to set each leg individually. In addition, leveling tripods have all the features and benefits of the Gitzo Mountaineer carbon fiber range.

All-purpose tripods with particular advantages for panoramic, architecture and nature photographers among others, they are leveled instantly with the simple twist of a knob, making them perfect for shooting on uneven terrain. Features include a silky-smooth rapid center column that's grooved to prevent rotation, a stainless steel weight hook for added stability, a removable spirit level at the center column base, and ergonomic rubber grip locks for easy handling. Up to 30% lighter than an equivalent aluminum tripod yet it does not compromise on strength, torsional stability or durability.



- ◆ Open the tripod, leaving the center column down. Loosen the leveling system locking knob. Adjust the center column inclination to get it level; for reference use the built-in bubble spirit level. When the column is correctly leveled, tighten the locking knob. Slide the center column to the required height.



- ◆ Constructed using a dual "screw thread and glue" jointing technology called "H.I.S." which provides greater durability and reliability than alternative methods.



Center column locking collar

### PERFECTLY LEVEL

Gitzo's G1227LVL and G1228LVL leveling generation of photographic supports: the column (+/-12°) lets you set your camera perfectly level without adjustment of the tripod legs, and keeps your equipment closer to the vertical of the tripod's center of gravity for more stable shooting on uneven terrain.



Traditional tripod

Gitzo leveling tripod

- ◆ The center column locking collar above the shoulder makes it easy to move the column up and down. The rapid column can easily be inverted for an alternative shooting angle or low level macro work.
- ◆ "Performance" tripods are fitted with sliding stops, which enable the legs to be individually set at different angles, providing more flexibility and permitting very low angle shooting.
- ◆ Telescopic leg extensions and center columns are fitted with anti-slippage rubber cushioned locking rings.
- ◆ Built-in hook accessory allows you to hang a stabilizing weight (e.g. a full camera bag or a sand/water bag) on the bottom of the tripod. Useful with long, heavy lenses on uneven ground or in windy conditions.

|                       | Column Type | Leg Sections | Max. Height with Extended Center Column | Max. Height Column Down | Minimum Height | Closed Height | Weight   | Max. Load Capacity | Price  |
|-----------------------|-------------|--------------|---|-------------------------|----------------|---------------|----------|--------------------|--------|
| G1228LVL (GIG1228LVL) | Rapid       | 4            | 61"                                     | 52.3"                   | 12.6"          | 21.6"         | 3.84 lbs | 17.6 lbs           | 688.95 |
| G1227LVL (GIG1227LVL) | Rapid       | 3            | 63.8"                                   | 55.1"                   | 13.4"          | 25.6"         | 3.84 lbs | 17.6 lbs           | 649.95 |



EQUIPMENT LEASING AVAILABLE

## SYSTEMATIC SERIES

The Systematic tripod is a Gitzo exclusive. This system allows you to customize the tripod to your particular needs. All components from systematic series 3 to 5 tripods are interchangeable.

- ◆ Systematic tripods are constructed using a “screw thread and glue” dual jointing technology pioneered by Gitzo called “H.I.S.”. This provides greater strength and stability on location.
- ◆ Telescopic leg extensions can be set without slippage with rubber cushioned locking rings and wing locks.
- ◆ “Performance” tripods are fitted with sliding stops, which enable the legs to be individually set at different angles, providing more flexibility and permitting very low angle shooting.

### geared column

Only in aluminum



### video adapters

Although designed for video applications, the G1321 is ideal for quick leveling of all heads.

|                |                 |                        |
|----------------|-----------------|------------------------|
| G1422<br>75 mm | G1424<br>100 mm | G1321<br>Leveling base |
|----------------|-----------------|------------------------|



### rapid columns

|                  |                      |
|------------------|----------------------|
| Aluminum version | Carbon fiber version |
|------------------|----------------------|





All Systematic tripods are supplied with a flat plate. The optional camera attachments can be fitted by simply unlocking the bolt in the top casting, lifting out the flat plate and dropping in the alternative adapter or column.

### Carbon Fiber Versions:

Gitzo carbon fiber tubes use an exclusive process based on pull winding of long carbon fibers which are precisely wrapped and combined under high pressure and temperature with epoxy resin to a 1.5mm wall thickness. This manufacturing process ensures stiff, light tubes resistant to bending, having superior tensile and compression strength, and a high degree of stability in extreme temperatures. The tubes also absorb vibration and withstand fatigue better than those made by other carbon fiber tube processes.



### Aluminum Versions:

The aluminum version is built with 1.5mm thick tubes of high strength lightweight aluminum alloy to ensure absolute stability and durability.

- ◆ Aluminum tripods have wing nuts on the top leg section for ease of operation.
- ◆ Aluminum versions incorporate the universal foot system with rubber feet and optional stainless steel spikes and other accessories.

# GITZO

## SYSTEMATIC SERIES

TRIPODS

452



### Systematic Studex Tripods

The Studex range of tripods is the workhorse of professional photographers. These tripods will support long telephoto lenses on 35mm, medium format and even light view cameras. They offer an ideal balance of strength and weight for photographers on the go, who nevertheless require the extra stability for loads up to 26 lbs.

**G1345 Performance Aluminum Tripod**  
The G1345 is a four-section aluminum tripod that extends to 59.9", goes down to an amazing 3.9" and folds to a compact 23.3". It weighs 6.1 lbs. and supports a maximum load of 22 lbs.....**377.95**

**G1325 Performance CF Tripod**  
The G1325 is a three-section carbon fiber tripod with flat plate. It extends to 58.3", goes down to 4.3" and folds to a compact 26.4". It weighs 4.5 lbs. and supports a maximum load of 26.5 lbs.....**529.95**

**G1340 Performance Aluminum Tripod**  
The G1340 is a three-section aluminum tripod with flat plate. It extends to 60.2", goes down to 4.3" and folds to a compact 28.3". It weighs 6.4 lbs. and supports a maximum load of 22 lbs.....**329.95**

**G1348 Performance CF Tripod**  
The G1348 is a four-section carbon fiber tripod with flat plate. It extends to 65.7", goes down to 4.3" and folds to a compact 24". It weighs 4.8 lbs. and supports a maximum load of 26.5 lbs.....**649.95**

### Systematic Pro Studex Tripods

Pro studex tripods are designed for large format cameras up to 8x10", long telephoto lenses and video/ ENG applications on location. Available only in aluminum, the Pro Studex range provides uncompromising support for loads up to 26.4 lbs.

**G1415 Performance Aluminum Tripod**  
The G1415 is a four-section aluminum tripod that extends to 46.1", goes down to 5.5" and folds to a compact 20.1". Weighs 6.7 lbs. and supports a maximum load of 26.5 lbs.....**369.95**

**G1410 Performance Aluminum Tripod**  
The G1410 is a three-section aluminum tripod that extends to 64.6", goes down to 7.5" and folds to 29.8". Weighs 8.4 lbs. and supports a maximum load of 26.5 lbs.....**369.95**

|                            | Style       | Material     | Leg Sections | Maximum Height | Minimum Height | Closed Height | Weight   | Max. Load Capacity |
|----------------------------|-------------|--------------|--------------|----------------|----------------|---------------|----------|--------------------|
| <b>G1345</b> (GIG1345)     | Performance | Aluminum     | 4            | 59.9"          | 3.9"           | 23.3"         | 6.1 lbs  | 22 lbs             |
| <b>G1325</b> (GIG1325)     | Performance | Carbon fiber | 3            | 58.3"          | 4.3"           | 26.4"         | 4.5 lbs  | 26.5 lbs           |
| <b>G1340</b> (GIG1340)     | Performance | Aluminum     | 3            | 60.2"          | 4.3"           | 28.3"         | 6.4 lbs  | 22 lbs             |
| <b>G1348</b> (GIG1348)     | Performance | Carbon fiber | 4            | 65.7"          | 4.3"           | 24"           | 4.8 lbs  | 26.5 lbs           |
| <b>G1415</b> (GIG1415)     | Performance | Aluminum     | 4            | 46.1"          | 5.5"           | 20.1"         | 6.7 lbs  | 26.5 lbs           |
| <b>G1410</b> (GIG1410)     | Performance | Aluminum     | 3            | 64.6"          | 7.5"           | 29.9"         | 8.4 lbs  | 26.5 lbs           |
| <b>G1515</b> (GIG1515)     | Performance | Aluminum     | 2            | 47.2"          | 7.7"           | 32.3"         | 8.3 lbs  | 44.1 lbs           |
| <b>G1505</b> (GIG1505)     | Performance | Aluminum     | 4            | 58.7"          | 6.3"           | 24"           | 9 lbs    | 33.1 lbs           |
| <b>G1548</b> (GIG1548)     | Performance | Carbon fiber | 4            | 59.1"          | 5.9"           | 23.2"         | 6.7 lbs  | 33.1 lbs           |
| <b>G1500</b> (GIG1500)     | Performance | Aluminum     | 3            | 61.8"          | 7.5"           | 29.5"         | 9.7 lbs  | 33.1 lbs           |
| <b>G1548GT</b> (GIG1548GT) | Performance | Carbon fiber | 6            | 91.3"          | 6.7"           | 27.2"         | 8.2 lbs  | 33.1 lbs           |
| <b>G1504</b> (GIG1504)     | Performance | Aluminum     | 5            | 99.6"          | 6.9"           | 31.1"         | 12.3 lbs | 33.1 lbs           |



## SYSTEMATIC SERIES

### Systematic Tele Studex Tripods

The tele studex range of tripods is the ultimate support at all heights from 5.9" to 99.6". Available in carbon and aluminum, the tele studex range is designed for large format studio, architectural photographers and ENG or news videography when rugged stability and flexibility is required.



#### G1515 Aluminum Tripod (GIG1515)

The G1515 is a two-section aluminum tripod that extends to 47.2", goes down to 7.7" and folds to 32.3". Weighs 8.3 lbs. and supports loads up to 44.1 lbs.....**427.95**

#### G1505 Aluminum Tripod (GIG1505)

The G1505 is a four-section aluminum tripod that extends to 58.7", goes down to 6.3" and folds to a compact 24". Weighs 9 lbs. and supports loads up to 33.1 lbs .....**427.95**

#### G1548 Carbon Fiber Tripod (GIG1548)

The 4-section G1548 weighs in at an 6¼ lbs, yet can support a maximum load of up to 33 lbs. It extends up to 59.1" goes down to 5.9" and folds to a compact 23.2" .....**749.95**

#### G1500 Aluminum Tripod (GIG1500)

The G1500 is a 3-section aluminum tripod that extends to 61.8", goes down to 7.5" and folds to 29.5". Weighs 9.7 lbs. and supports a maximum load of 33 lbs .....**427.95**

#### G1548GT Carbon Fiber Tripod (GIG1548GT)

A 6-section carbon fiber tripod that extends to an incredible 91.3", goes down to 6.7" and folds to 27". Weighs 8 lbs. and supports a maximum load of 33 lbs .....**849.95**

#### G1504 Aluminum Tripod (GIG1504)

The G1504 is a 5-section aluminum tripod that extends to 99.6", goes down to 6.9" and folds to 31.1". Weighs 12.3 lbs. and supports a maximum load of 33.1 lbs.....**554.95**

### Columns

Center columns are important accessories for the Systematic range of tripods, giving extra height and facilitating height changes. The geared versions allow even finer height adjustment, and, thanks to their anti-rollback mechanism, are more secure during raising and lowering when heavy photographic equipment is mounted on the tripod.



| Model           | Columns       | Series | Material     | Column Type | Min. Height | Max. Height | Weight   | Price         |
|-----------------|---------------|--------|--------------|-------------|-------------|-------------|----------|---------------|
| G338 (GIG338)   | Geared column | 3      | Aluminum     | Geared      | 9.4"        | 13.94"      | 2.16 lbs | <b>249.95</b> |
| G1317 (GIG1317) | Rapid column  | 3      | Aluminum     | Rapid       | 11.38"      | 14.92"      | 1.5 lbs  | <b>89.95</b>  |
| G1318 (GIG1318) | Rapid column  | 3      | Carbon fiber | Rapid       | 12.2"       | 15.75"      | 1.07 lbs | <b>109.95</b> |
| G528 (GIG528)   | Geared column | 4/5    | Aluminum     | Geared      | 8.07"       | 14.76"      | 3.17 lbs | <b>309.95</b> |
| G1529 (GIG1529) | Geared column | 4/5    | Aluminum     | Geared      | 10.39"      | 32.44"      | 4.1 lbs  | <b>479.95</b> |
| G1527 (GIG1527) | Rapid column  | 4/5    | Aluminum     | Rapid       | 11.06"      | 14.92"      | 1.92 lbs | <b>94.95</b>  |
| G1518 (GIG1518) | Rapid column  | 5      | Carbon fiber | Rapid       | 13.54"      | 17.4"       | 1.41 lbs | <b>119.95</b> |



### Video Adapters

**G1422 Adapter (GIG1422):** When you need to mount a video head with a half ball base, the ball adapters transform your systematic photo tripod into a high performance video tripod. Compatible with all 75mm half ball video heads .....**39.95**

**G1424 Adapter (GIG1424):** Same as G1422 but compatible with all 100mm half ball video heads .....**59.95**

**G1321 Level Base (GIG1321):** The leveling base fits systematic tripods and allows you to level the head plate without adjusting each leg individually or losing stability. It has ±15° adjustment and is fitted with a spirit level. A toggle lever guarantees efficient locking .....**159.95**

# GITZO

## EXPLORER SERIES

TRIPODS

454

### Aluminum and Carbon Fiber Tripods

The Explorer is possibly the most versatile tripod in the world, and a first choice for outdoor photographers. Thanks to its totally free leg angle positions and offset center column inclination, it will hold your camera steady in places you wouldn't believe and let you capture pictures previously beyond your horizons. They feature individually locking legs that can be fixed at any angle from 0° to 90°. The column tilts from the vertical, right over beyond the horizontal and lock solidly at any angle. A swivel on the column lets you position the angled column over a leg for stability, or between the spread legs to shoot straight down onto the floor. Available in carbon fiber or aluminum.

- ◆ The technical solutions devised for the Explorer include free leg angle locking, the offset center column with free inclination and rotation locking. Combined with the features common to all Gitzo tripods, such as the stabilizing hook and invertable column, they'll help you discover new ways of using a tripod.
- ◆ The Explorer is fitted with a column that can tilt from the vertical, beyond the horizontal and lock safely at any angle.
- ◆ They have individually locking legs that can be fixed at any angle from 0° to 90°
- ◆ Telescopic leg extensions and center columns are fitted with anti-slippage rubber cushioned locking rings and "wingnut" locks.



◆ The carbon fiber (CF) versions are built with exclusive pull-wound tubes: long fibers are precisely wrapped and combined with resin under high pressure and temperature until the wall thickness reaches 1.5mm. Tubes are resistant to bending and stable in extreme temperatures. They have greater tensile and compression strength, so absorb vibration and withstand fatigue better. The CF tripods are also constructed using a dual "screw thread and glue" jointing technology pioneered by Gitzo called "H.I.S." which provides greater durability and reliability than alternative methods.

◆ The aluminum version is built with 1.5mm thick tubes of high strength lightweight aluminum alloy to ensure absolute stability and durability. The aluminum version features the Gitzo universal foot system with rubber feet that cover stainless steel spikes.

#### G2220 (GIG2220)

##### Three-section Aluminum Tripod

Traditional silver-grey color. Maximum height of 64" and a weight of 5.1 lbs. ....239.95

#### G2227 (GIG2227)

##### Three-section Carbon Fiber Tripod

Maximum height of 67.3", a weight of 4.41 lbs. and a maximum load of 13.2 lbs. The minimum height is only 4 1/2" .....469.95

#### G2228 (GIG2228)

##### Four-section Carbon Fiber Tripod

Maximum height of 65.5", a weight of 4.4 lbs. and a maximum load of 13.2 lbs. The minimum height is only 4 1/2" .....539.95

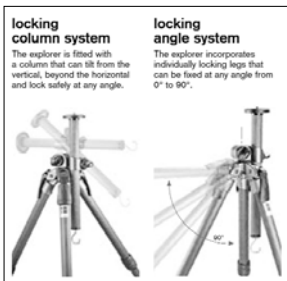

|       | Material     | Column type | Leg sections | Max. height with extended center column | Max. height column down | Min. height | Closed height | Weight   | Max. Load Capacity |
|-------|--------------|-------------|--------------|---|-------------------------|-------------|---------------|----------|--------------------|
| G2220 | Aluminum     | Rapid       | 3            | 64"                                     | 49.8"                   | 4.5"        | 25.2"         | 5.1 lbs. | 13.2 lbs.          |
| G2228 | Carbon fiber | Rapid       | 4            | 65.5"                                   | 54.3"                   | 4.5"        | 22"           | 4.4 lbs. | 13.2 lbs.          |
| G2227 | Carbon fiber | Rapid       | 3            | 67.3"                                   | 55.9"                   | 4.5"        | 26.4"         | 4.4 lbs. | 13.2 lbs.          |



For Any Inquiries Regarding Your Order, Call Our Customer Service:  
(800) 221-5743 • (212) 239-7765 • FAX: (800) 947-2215 • (212) 239-7549

### Classic Aluminum Tripods

Used by professionals around the world, Gitzo classic aluminum tripods are individually hand-assembled with painstaking care using the finest high strength alloys. They cover a wide range of different maximum load capacities for different camera equipment. Stated maximum loads refer to the weight the tripod supports when fully extended and with the load evenly balanced above the its center of gravity. Designed to accommodate any requirement, classic tripods also offer a choice of either rapid or geared center column.

- ◆ Sport, Reporter and Studex tripods are constructed using a dual “screw thread and glue” jointing (H.I.S) technology for durability and reliability.
- ◆ “Performance” tripods are fitted with sliding stops, which enable the legs to be individually set at different angles, for more flexibility and low angle shooting.
- ◆ On rapid center column tripods, the center column locking collar makes it easy to adjust the column quickly. It can also easily be inverted for an alternative shooting angle or low level macro work.
- ◆ Telescopic leg extensions and center columns have anti-slipage rubber cushioned locking rings and “wingnut” locks.
- ◆ On geared models, the gear mechanism allows you to precisely adjust the height of the column. An anti-rollback system keeps heavy equipment safely supported, and can be disengaged while winding down.
- ◆ Reporter’s removable rubber leg tip is interchangeable with Gitzo universal accessories such as the big foot, long spike, etc.

#### G0012 Classic Table Tripod (GIG0012)

Ideal for compact cameras or for special applications, the G0012 is a 2-section mini-tripod that features a rapid center column to offer rigidity for low-angle shooting. Extremely portable, the G0012 closes down to 9.8” to fit in an accessory bag or briefcase. Maximum height is 11” (18” with extended column), and the minimum height is 8.7”. The maximum load is 5½ lb .....149.95



#### G1212 Classic Reporter Tripod (GIG1212)

A 3-section tripod with a geared center column, the G1212 Classic Reporter is ideal for SLR and medium format cameras. It has a maximum height of 69.3”, and a minimum height of 18.3”. It also includes a universal foot system which accepts accessories such as spiked feet.....374.95

#### Classic Studex Tripods

A professional tripod for mounting all SLR cameras with heavier lenses. The Studex range incorporates the universal foot system, which provides a combination of spiked feet with rubber caps. Available with grooved rapid or geared center column.

#### G1312 Studex Performance Tripod with Geared Column (GIG1312)

A three-section tripod with a geared center column. It has a maximum height of 69.3”, and a minimum height of 17.3” .....424.95

#### G1320 Studex Performance Tripod with Groove Rapid Column (GIG1320)

A three-section tripod with a grooved rapid center column. It has a maximum height of 75.2”, and a minimum height of 19.3” .....339.95

#### G1326 Studex Compact Performance Tripod with Groove Rapid Column (GIG1326)

A 4-section tripod with a grooved rapid center column. It has a maximum height of 70.5”, and a minimum height of 16.1” .....399.95

#### G1118 Classic Sport Tripod (GIG1118)

A good choice when shooting on location. This tripod offers rapid center columns and a variable leg angle spread. In addition, the center column can be reversed for flat art copy work. 3-section legs plus a geared column. With an optional extra-low column, ground level shooting is simple. It is also ideal for spotting scope and binocular support. It has a maximum height of 51.6”, and a minimum height of 11.4” .....319.95



See specifications on page 489



# GITZO

## BASALT SERIES

TRIPODS

456

### ***“Rock Solid” Tripod Made from Space-Age Materials***

From deep down in the earth's crust molten rock erupts from a volcano. The lava that is forced out consists of a black dense rock known as basalt. From this rock Gitzo has produced another first in tripod history. Using our know-how and experience of technological materials such as carbon and magnesium, the basalt rock is transformed into fiber and through a complex 3D process creates a tubing of exceptional performance. Basalt is as tough as aluminium but much lighter, is better at absorbing vibrations and is also recyclable. Introducing the first 'rock solid' tripod created by nature for Gitzo.

Basalt rock is extracted, crushed and melted into a liquid at 1500°C (2732 °F) in a furnace called a 'feeder'. The melted liquid is forced through a mechanism with a number of tiny orifices to create the continuous basalt fibre. Temperatures are precisely controlled throughout the whole process. The tube fabrication The long basalt fibers are then sent to the pultrusion plant where the fibers are passed through a resin-impregnation bath and drawn through a shaping die to form a multi-layer tube of exceptional performance.

Using its know-how and experience of advanced materials such as carbon and magnesium; Gitzo is the first and only manufacturer world to produce such a highly technological tripod. Combining all of its expertise and knowledge Gitzo has created a new generation of tripods to answer the ever-increasing demands of today's professional photographers.



**Rapid**

**Reversible  
Column**

**Performance**

**Fast (ALR)**

**Hook**

**Leg Ends**

- ◆ Created by nature for Gitzo, the all-new basalt fiber tripod range is designed for demanding professionals who want the features and performance of carbon fiber tripods, at a price that is very affordable. These tripods are built with composite basalt tubing - which is 20% lighter than aluminum tubing without compromising durability. Basalt tripods incorporate all of Gitzo's pioneering features, including anti-rotation leg sections and reinforced removable spikes. Basalt tripods are Gitzo's new standard, perfectly suited for all types of cameras from compact digital to medium format film.
- ◆ All tripods (except the G1097) are constructed using a dual "screw thread and glue" jointing technology pioneered by Gitzo called "H.I.S." which provides greater durability and reliability than alternative methods.
- ◆ New ALR (Anti-Leg Rotation) system means the tripod can be opened in less than 15 seconds. Simply loosen all the twist locks on each leg at the same time, then pull the leg down and tighten the twists individually.
- ◆ "Performance" tripods are fitted with sliding stops, which enable the legs to be individually set at different angles, providing more flexibility and permitting very low angle shooting.
- ◆ The center column locking collar above the tripod shoulder makes it easier to adjust the column quickly. Series 1 and above are built with an anti-rotation grooved center column for improved stability
- ◆ The rapid column can easily be inverted for an alternative shooting angle or low level macro work.
- ◆ Removable rubber leg tip is interchangeable with Gitzo universal accessories such as the big foot, long spike, etc
- ◆ The built-in accessory hook provides a place to hang a stabilizing counterweight (e.g. a camera bag or a sand/water bag) on the bottom of the center column., This is especially useful with long heavy lenses, on uneven ground or in windy conditions. The newly redesigned hook is retractable, so it takes up less space and won't snag on clothing or equipment.



## BASALT SERIES

TRIPODS

457

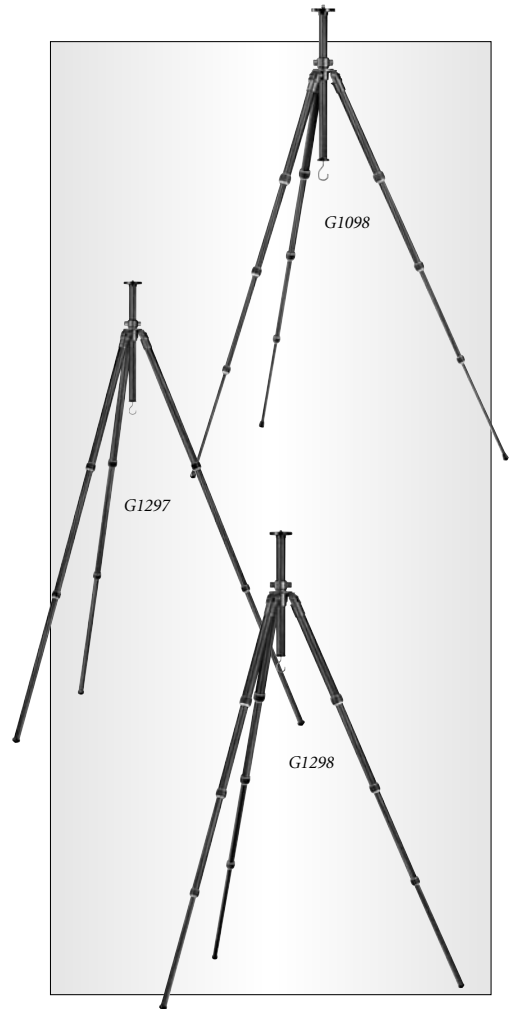

### Weekend Series Tripods

A very compact, yet sturdy tripod for mounting compact digital cameras, lightweight 35mm equipment and small camcorders.

#### G1097 Weekend Performance Tripod with Rapid Column (GIG1097)

A three section tripod with a rapid center column. It has a maximum height of 46.9", a minimum height of 15" and folds down to 16.9". Supports up to 4.4 lbs. ....268.95

#### G1098 Weekend Performance Tripod with Rapid Column (GIG1098)

A four section tripod with a rapid center column. It has a maximum height of 51.2", a minimum height of 14.2" and folds down to 18.1". Supports up to 4.4 lbs. ....299.95

### Sport Series Tripods

A good choice for lightweight digital and 35mm cameras when shooting on location. The tripod is also a natural choice for spotting scopes, binocular support or even light camcorders.

#### G1197 Weekend Performance Tripod with Rapid Column (GIG1197)

A three section tripod with a rapid center column. It has a maximum height of 60.2", a minimum height of 16.9" and folds down to 22". Supports up to 8.8 lbs. ....299.95

#### G1198 Weekend Performance Tripod with Rapid Column (GIG1198)

A four section tripod with a rapid center column. It has a maximum height of 47.2", a minimum height of 14.6" and folds down to 16.1". Supports up to 8.8 lbs. ....324.95

### Reporter Series Tripods

Ideal tripod range for 35mm SLR and medium format cameras from 6x4.5 to lightweight 6x6 plus camcorders.

#### G1297 Weekend Performance Tripod with Rapid Column (GIG1297)

A three section tripod with a rapid center column. It has a maximum height of 61", a minimum height of 17.3" and folds down to 23.2". Supports up to 12 lbs. ....324.95

#### G1298 Weekend Performance Tripod with Rapid Column (GIG1298)

A four section tripod with a rapid center column. Has a maximum height of 58.3", a minimum height of 16.5" and folds down to 19". Supports up to 12 lbs. ....347.95

### CLASSIC SERIES & BASALT SERIES SPECIFICATIONS

|       | Column Type | Leg Sections | Maximum Height with Extended Center Column | Maximum Height Column Down | Minimum Height | Closed Height | Weight  | Maximum Load Capacity |
|-------|-------------|--------------|--|----------------------------|----------------|---------------|---------|-----------------------|
| G0012 | Rapid       | 2            | 18.1"                                      | 11"                        | 8.7"           | 9.8"          | 0.9 lbs | 5.5 lbs               |
| G1118 | Geared      | 3            | 51.6"                                      | 45.7"                      | 11.4"          | 21.7"         | 3.6 lbs | 9.9 lbs               |
| G1212 | Geared      | 3            | 69.3"                                      | 56.7"                      | 18.3"          | 26"           | 5.8 lbs | 13.2 lbs              |
| G1312 | Geared      | 3            | 69.3"                                      | 61.4"                      | 17.3"          | 29.1"         | 7.3 lbs | 22 lbs                |
| G1326 | Rapid       | 4            | 70.5"                                      | 60.2"                      | 16.1"          | 24.8"         | 6.8 lbs | 22 lbs                |
| G1320 | Rapid       | 3            | 75.2"                                      | 62.2"                      | 19.3"          | 29.9"         | 7.3 lbs | 22 lbs                |
| G1097 | Rapid       | 3            | 46.9"                                      | 35.4"                      | 15"            | 16.9"         | 1.5 lbs | 4.4 lbs               |
| G1098 | Rapid       | 4            | 51.2"                                      | 39.4"                      | 14.2"          | 18.1"         | 1.8 lbs | 4.4 lbs               |
| G1197 | Rapid       | 3            | 60.2"                                      | 46.5"                      | 16.9"          | 22"           | 2.8 lbs | 8.8 lbs               |
| G1198 | Rapid       | 4            | 47.2"                                      | 38.6"                      | 14.6"          | 16.1"         | 2.4 lbs | 8.8 lbs               |
| G1297 | Rapid       | 3            | 61"  | 47.2"                      | 17.3"          | 23.2"         | 3.4 lbs | 12.1 lbs              |
| G1298 | Rapid       | 4            | 58.3"                                      | 47.2"                      | 16.5"          | 19.3"         | 3.4 lbs | 12.1 lbs              |

# GITZO

## TRIPOD HEADS

TRIPODS

458

The Gitzo range is composed of different styles of heads that allow you to choose the best head for your needs. Each Gitzo head has been carefully designed to work with a specific tripod series. There are heads in various designs and sizes which allow the photographer to position any camera precisely for the required shooting position, with minimum effort to obtain optimum results. Gitzo introduced Magnesium heads to the photographic industry, which offer the advantage of being up to 20% lighter - and make perfect partners to Gitzo carbon fiber tripods. Gitzo heads cover all angles!



G1377M  
Center  
Ball  
Head

### Center Ball Heads

Exceptional fluid movement and total locking stability are the targets set for Gitzo's range of center ball heads. With their ergonomic design, they are easy and intuitive to use, while their advanced precision engineering guarantees high performance locking with a wide range of camera equipment. Independent pan and tilt controls lock the head exactly where it is set, without movement. All locking knobs have a rubber coating for a softer touch and an excellent grip.

The G1177M features a single lock for rapid and reliable locking in any position. The innovative Teflon coating applied to the ball surface of the larger heads (G1277M/G1377M and G1378M) makes camera positioning adjustments smoother than ever by eliminating all traces of jarring and skipping. The G1377M and G1378M incorporate a separate friction control which can be set to counterbalance the weight of the camera, giving total control over the finest adjustments.

|        | Series | Plate Type                           | Pan  | Tilt      | Pan Locking | Ball Locking | Friction Control | Height | Weight   | Max Capacity | Price  |
|--------|--------|--------------------------------------|------|-----------|-------------|--------------|------------------|--------|----------|--------------|--------|
| G0077  | 00     | Fixed with 1/4-20" screw             | 360° | +90°/-20° |             |              |                  | 2.3"   | 0.17 lbs | 2.2 lbs      | 36.95  |
| G1077M | 0      | Fixed with 1/4-20" screw             | 360° | +90°/-20° |             |              |                  | 2.3"   | 0.26 lbs | 4.4 lbs      | 68.95  |
| G1177M | 1      | Fixed with rev. 1/4-20" - 3/8" screw | 360° | +90°/-20° |             |              |                  | 3.5"   | 0.68 lbs | 8.8 lbs      | 96.95  |
| G1277M | 2      | Fixed with rev. 1/4-20" - 3/8" screw | 360° | +90°/-30° | •           | •            |                  | 4.5"   | 1.1 lbs  | 13.2 lbs     | 138.95 |
| G1377M | 3      | Fixed with rev. 1/4-20" - 3/8" screw | 360° | +90°/-40° | •           | •            | •                | 5.3"   | 1.9 lbs  | 17.6 lbs     | 199.95 |
| G1378M | 3      | Quick Release with 1/4-20" screw     | 360° | +90°/-40° | •           | •            | •                | 5.7"   | 2.4 lbs  | 17.6 lbs     | 274.95 |

### Off-Center Ball Heads

Gitzo off-center ball heads offer a range of movement impossible with conventional heads, and are renowned for their smooth operation and positive locking mechanisms. The rotating center socket is the reason why they let you reach so many unusual angles. In fact, it's so extreme and so versatile that it allows a camera mounted on an inverted center column to be set right side up! A graduated base with independent lock allows perfect panoramic positioning. A teflon-based anodizing process gives it a refined, super-smooth movement.

These lightweight magnesium (20% lighter than the equivalent aluminum alloy head) off-center heads offer fixed or quick release camera plate versions. All non-quick release plate models have a single "P" slot for the camera mounting screw to allow fine positioning on the camera on the head. The design of these heads allows you to work in any axis which makes it the perfect head for the Explorer range of tripods.



G1275M Off-Center Ball Head

|        | Series | Plate Type                       | Pan  | Side Tilt | Front/Back Tilt | Height | Weight   | Max Capacity | Price  |
|--------|--------|----------------------------------|------|-----------|-----------------|--------|----------|--------------|--------|
| G1275M | 2      | Fixed with 1/4-20" screw         | 360° | +90°      | 360°            | 4.33"  | 1.21 lbs | 11 lbs       | 149.95 |
| G1276M | 2      | Quick release with 1/4-20" screw | 360° | +90°      | 360°            | 4.72"  | 1.41 lbs | 11 lbs       | 184.95 |
| G1375M | 3      | Fixed with 1/4-20" screw         | 360° | +90°      | 360             | 5.12"  | 1.84 lbs | 13.2 lbs     | 192.95 |
| G1376M | 3      | Quick release with 1/4-20" screw | 360° | +90°      | 360°            | 5.51"  | 2.07 lbs | 13.2 lbs     | 219.95 |
| G1575M | 5      | Fixed with 1/4-20" screw         | 360° | +90°      | 360°            | 5.51"  | 2.6 lbs  | 22 lbs       | 248.95 |
| G1576M | 5      | Quick release with 1/4-20" screw | 360° | +90°      | 360°            | 5.91"  | 2.82 lbs | 22 lbs       | 292.95 |



**ONE HOUR FREE PARKING**  
AT 349 W. 34th STREET (with purchase of \$100 or more)

## TRIPOD HEADS



G2380  
Fluid Head

### Fluid Heads

Fluid heads are ideally suited to lightweight ENG and prosumer camcorders, enabling professional, smooth panning and solid locking. They also work well with still photography when controlling long lenses and creating dramatic telephoto pan effects. Weighing a mere 3 lbs., the G2380 is perfect for location work. With fluid control it provides exceptionally smooth pans and tilts. Friction for both pan and tilt planes is fully adjustable to perfectly match the weight of your camera. Tightening a knob in the center of the friction control can also independently lock both movements. A sliding quick-release plate also allows the camera to be easily mounted and balanced from either the front or the rear, and a built-in secondary safety catch protects the camera from accidentally sliding off the head. Last, it incorporates a pan bar that converts in seconds for either right or left-hand operation.

The G1380 has separate pan and tilt variable drag control to produce smooth movement without detectable stops and starts. A separate pan and tilt lock is included and the sliding camera plate, used to balance the camera, can be rapidly locked or unlocked from the head with the camera still attached. A safety release is also incorporated to prevent the camera accidentally falling off. Include six versions color-coded tension springs for precision balancing for payloads from 2.2 lbs. to 22 lbs... in effect, six heads in one!

|              | Series | Plate Type                      | Pan  | Front Tilt | Height | Weight   | Max. Capacity | Price         |
|--------------|--------|---------------------------------|------|------------|--------|----------|---------------|---------------|
| <b>G2380</b> | 2      | QR with 1/4-20" and 3/8" screws | 360° | +90°/-90°  | 5.31"  | 3.09 lbs | 11 lbs        | <b>189.95</b> |
| <b>G1380</b> | 3      | QR with two 3/8" screws         | 360° | +90°/-90°  | 3.15"  | 3.07 lbs | 22 lbs        | <b>849.95</b> |

### Low Profile Heads

Three fluid heads designed from the ground up to be of the highest quality, the G2270M (long plate), G2271M (compact plate) and the G2272M (QR plate) offer silky smooth movement while providing precise camera settings. Ideal for photo, bird watching or even mini DV cameras there is absolutely no jerking when these heads are panned, tilted or levelled. Made of high-quality, low-weight magnesium, they support equipment up to 12 lbs.

They feature multiple spirit levels to ensure the head is perfectly level. Rubber o-ring gaskets around the locking bushings keep them securely in place if the side-to-side tilt handle is removed to save space during transportation. Ergonomically designed pan and tilt handles have easy to use triangular shaped rubber grips. Side to side tilt handle can be positioned on the right or left-hand side of the head.

The fixed plate G2270M and G2271M have anti-rotation pins (stored in pre-drilled holes under the head when not in use) to ensure the camera will remain perfectly stable when shooting in portrait mode. Complimenting this is a large hexagonal thumbscrew on the bottom of the camera locking screw to make it easier than ever to attach and remove equipment to the head.

The G2272M utilizes a quick-release locking system that even if equipment isn't securely locked down, will prevent it from falling off the head. Removing the camera and lens is simple and fast. Simply press the lock release button and slide the plate out.

Normally, when shooting in portrait mode with a low-profile head, up and down tilt is lost. With the G2272M's square non-keyed QR plate, the camera can be positioned in the adapter sideways so that when it's positioned in portrait mode up and down tilt is available. In addition, by keeping any side of the mounting plate parallel to the back or front of the camera will ensure perfect alignment without having to worry how the plate fits on the adapter.



G1380M  
Low Profile Head

|                          | Front Tilt | Side Tilt   | Plate Type    | Equipment Mount      | Height | Weight   | Max. Capacity | Price         |
|--------------------------|------------|-------------|---------------|----------------------|--------|----------|---------------|---------------|
| <b>G2270M (GIG2270M)</b> | +95°/-50°  | +100°/-100° | Fixed         | 1/4-20" + 3/8" screw | 3.94"  | 1.65 lbs | 12.2 lbs      | <b>239.95</b> |
| <b>G2271M (GIG2271M)</b> | +95°/-60°  | +100°/-100° | Fixed         | 1/4-20" + 3/8" screw | 3.94"  | 1.54 lbs | 12.2 lbs      | <b>229.95</b> |
| <b>G2272M (GIG2272M)</b> | +95°/-50°  | +100°/-100° | Quick Release | 1/4-20" + 3/8" screw | 3.66"  | 1.59 lbs | 12.2 lbs      | <b>249.95</b> |
| <b>G1570M (GIG1570M)</b> | +90°/-20°  | +90°/-60°   | Fixed         | 1/4-20" + 3/8" screw | 4"     | 3.25 lbs | 22 lbs        | <b>244.95</b> |

# GITZO

## MONOPODS

TRIPODS

460

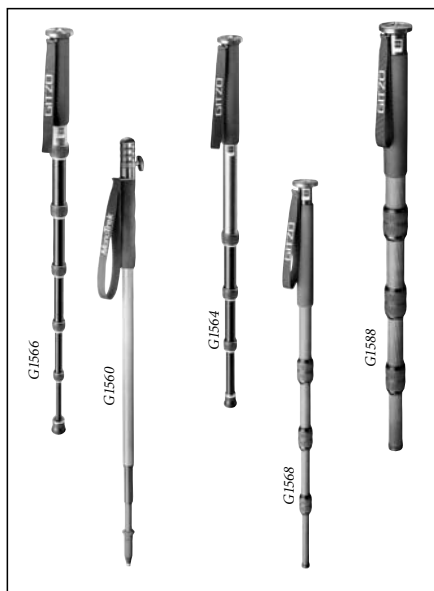

Gitzo monopods set the standard to which others can only aspire to. Carbon fiber models feature strong 1.5mm multi-layered, woven fiber tubes, cushioned hand grips, 3/8" or 1/4-20" mounting screws and non-slip twist locks. Aluminum models feature cushioned hand grips, 3/8" or 1/4-20" mounting screws and a universal foot system with rubber feet that accepts steel spiked feet and other accessories. No sporting or live action coverage would be complete without Gitzo monopods.

### G1560 MonoTrek with Center Ball Head (GIG1560)

The G1560 MonoTrek is an ergonomically designed lightweight monopod/walking stick, ideal for long distance walkers and backpackers. It is manufactured from light, high strength aluminum alloy. Supplied with removable ball head, telescopic height adjustment, steel spiked foot and snow shoe .....**119.95**

**G1564 Studex Monopod (GIG1564)**  
4 section aluminum monopod.....**119.95**

**G1568 Mountaineer Reporter Monopod (GIG1568)**  
4 section carbon fiber monopod.....**224.95**

**G1564L Studex XL Monopod (GIG1564L)**  
5 section aluminum monopod.....**134.95**

**G1578L Mountaineer Reporter Monopod (GIG1578L)**  
5 section carbon fiber monopod.....**259.95**

**G1566 Mini Studex Monopod (GIG1566)**  
6 section aluminum monopod.....**129.95**

**G1588 Mountaineer Tele-Studex Monopod (GIG1588)**  
4 section carbon fiber monopod.....**279.95**

### GITZO MONOPODS

|        | Construction | Minimum Height | Maximum Height | Weight   | Maximum Load | No. of Sections |
|--------|--------------|----------------|----------------|----------|--------------|-----------------|
| G1560  | Aluminum     | 31.9"          | 64.6"          | .9 lbs.  | 4.4 lbs.     | 3               |
| G1564  | Aluminum     | 23.2"          | 62.6"          | 2 lbs.   | 17.6 lbs.    | 4               |
| G1564L | Aluminum     | 23.6"          | 79.5"          | 2.1 lbs. | 17.6 lbs.    | 5               |
| G1566  | Aluminum     | 16.1"          | 58.1"          | 1.6 lbs. | 11 lbs.      | 6               |
| G1568  | Carbon Fiber | 21.9"          | 65"            | 1.2 lbs. | 8.8 lbs.     | 4               |
| G1578L | Carbon Fiber | 23.6"          | 77.6"          | 1.6 lbs. | 17.6 lbs.    | 5               |
| G1588  | Carbon Fiber | 22.8"          | 65"            | 2 lbs.   | 26.5 lbs.    | 4               |



### Lateral Arms

Lateral Arms enable cameras to be positioned above or below the tripod apex in positions which might otherwise be obstructed by the tripod legs. For optimum rigidity, make sure to select a lateral arm with the same diameter as the tripods outer section.

### LATERAL ARMS

| Model                  | Column Type | Height | Travel | Weight  | Price         |
|------------------------|-------------|--------|--------|---------|---------------|
| G530 Sport (GIG530)    | Rapid       | 16.9"  | 10.2"  | .75 lb. | <b>106.95</b> |
| G532 Reporter (GIG532) | Rapid       | 17.9"  | 13.3"  | 1.2 lb. | <b>124.95</b> |
| G535 Studex (GIG535)   | Geared      | 18.3"  | 11.2"  | 2 lbs.  | <b>334.95</b> |



## ACCESSORIES

### Padded Tripod Bag

These rainproof durable tripod bags have been designed to carry all sizes of tripods and heads, and they are built to last. Practical and stylish, all bags have a zip fastener for quick and easy access.



- G-E10P (GIGE10P)**  
For Series 0 (20.9").....**82.95**
- G-E11P (GIGE11P)**  
For Series 1 (30.3").....**79.95**
- G-E12P (GIGE12P)**  
For Series 2 (33.5").....**89.95**
- G-E13P (GIGE13P)**  
For Series 3 (38.2").....**134.95**
- G-E14P (GIGE140P)**  
For Series 4 (33.5").....**139.95**
- G-E15P (GIGE15P)**  
For Series 5 (45.3").....**144.95**

### G541 Graduated Right Angle Bracket

Series 4/5 center columns can be converted into lateral arms using the G541 (GIG541).....**138.95**

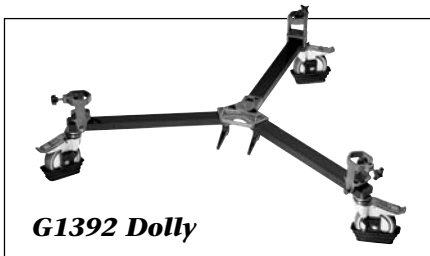

**G1392 Dolly**

The Gitzo dolly offers immediate maneuverability, folds easily and has individual locking wheels. This unit features a camera mounting screw for floor level shooting. Max load is 44 lbs. (GIG1392).....**329.95**



### Short Columns

Short columns are available for very low angle work.

| Model                     | Series | Material     | Column Type | Height | Weight   | Price        |
|---------------------------|--------|--------------|-------------|--------|----------|--------------|
| <b>G035B (GIG035)</b>     | 0      | Aluminum     | Rapid       | 4.72"  | 0.15 lbs | <b>29.95</b> |
| <b>G1135CB (GIG1135C)</b> | 1      | Aluminum     | Rapid       | 5.12"  | 0.39 lbs | <b>34.95</b> |
| <b>G1139B (GIG1139)</b>   | 1      | Carbon Fiber | Rapid       | 5.12"  | 0.22 lbs | <b>36.95</b> |
| <b>G1239B (GIG1239)</b>   | 2      | Carbon Fiber | Rapid       | 3.7"   | 0.22 lbs | <b>42.95</b> |
| <b>G1235CB (GIG1235C)</b> | 2      | Aluminum     | Rapid       | 5.51"  | 0.37 lbs | <b>34.95</b> |
| <b>G1339B (GIG1339)</b>   | 3      | Carbon Fiber | Rapid       | 5.9"   | 0.26 lbs | <b>49.95</b> |
| <b>G1335CB (GIG1335C)</b> | 3      | Aluminum     | Rapid       | 6.1"   | 0.48 lbs | <b>37.95</b> |
| <b>G1435B (GIG1435)</b>   | 4/5    | Aluminum     | Rapid       | 5.3"   | 0.44 lbs | <b>42.95</b> |
| <b>G1439B (GIG1439)</b>   | 5      | Carbon Fiber | Rapid       | 5.9"   | 0.31 lbs | <b>54.95</b> |

### Shoes and Spikes

**G1586B3 Location Shoe (GIG1586)**  
Set of 3 for Classic and Mountaineer .....**19.95**

**G1220.130B Big Foot (GIG1220130)**  
All terrain vibration absorber foot for mud, snow or sandy surfaces for all Monopods except the G1560 and G1588.....**24.95**

**G1220.130B3 Big Feet (GIG1220130B3)**  
Set of 3 of the above Big Foot all terrain vibration absorber feet.....**59.95**

**G1410.130B Big Foot (GIG1410130)**  
For G1588.....**24.95**

**G1410.130B3 Big Feet (GIG1410130B3)**  
Set of 3 Big Feet for the G1588 .....**72.50**

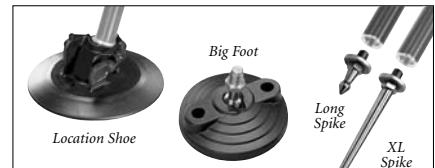

**G1220.129B Long Spike (GIG1220129B)**  
1.5" spike for monopods .....**13.95**

**G1220.129B3 Long Spikes (GIG1220129B3)**  
Set of 3 spikes for tripods.....**27.95**

**G1220.129LB XL Spike (GIG1220129LB)**  
4.7" extra long spike for a monopod .....**46.95**

**G1220.129LB3 XL Spikes (GIG1220129LB3)**  
Set of 3 extra long spikes for a tripod.....**113.50**

### Platforms

**G1539 Double Platform (GIG1539)**  
Heavy duty 17" platform enables cameras or 2 heads to be mounted at 13 3/4" centers to a tripod column .....**99.95**

**G1584 Double Platform (GIG1584)**  
11" platform enables cameras or two heads to be mounted at 8" centers to a tripod column .....**66.95**

**G065 Monitor Platform (GIG065)**  
A 13 x 15.7" platform which can be fitted to Gitzo tripods. Safely supports supplementary equipment, such as monitors, mixers, tape recorders.....**78.50**



**G1539  
Double  
Platform**



# HAKUBA

## BRANNER S5

TRIPODS

462

### Dual-Function Digital Photo Tripod

The Hakuba Branner S5 tripod breaks the mold for lightweight tripods with its new design and look. It sets the standard for compact recreational tripods featuring translucent body components accented by trendy, metallic colors. It is ultralight and compact - the perfect tripod for digital and conventional cameras, and ideal for outdoor/adventure photographers, videographers and backpackers - who truly appreciate the advantages of a full-featured, compact tripod.



- ◆ The Branner S5 is equipped with a three-way pan-head, a single handle control, a "quick-release" system for digital and 35mm cameras, high-quality cushioned camera quick shoe, and a geared center column.
- ◆ Features a locking brace design for added stability, and a braced, five-section pin-leg design that allows it to achieve a respectable height of 48".
- ◆ The tripod's panhead platform also flips up to the right for vertical camera positioning.
- ◆ The Branner S5 has a folded length of 14.2", a minimum operational height of 14", an extended height of 48" and weighs 28.6 oz.

Branner S5 Gold (HATBG).....44.95    Branner S5 Green (HATBGR) .44.95    Branner S5 Blue (HATBBL) .....44.95    Branner S5 Silver (HATBS).....44.95

### DTP-3 Digital Table Pod

Hakuba's three-section full/low-angle Digital Table Pod has a 360° angle adjustable panhead and a leg angle adjustment ring which allows for low angle adjustment. It also features a three-section leg extension. The compact size makes it an ideal accessory for digital cameras. Available with ball or 3-way pan head in multiple colors.



- ◆ Min/Max Height: 3½ and 11"    ◆ Folded Length: 6"    ◆ Weight: 4.2 oz.

#### DT-3 Table Pod

DTP-3 Champaign Gold (HATPCG) .....19.95  
 DTP-3 Titanium Gray (HATPTG).....19.95  
 DTP-3 Blue (HATPBL).....19.95  
 DTP-3 Purple (HATPP).....19.95  
 DTP-3 Pink (HATPPQ).....19.95  
 DTP-3 Red (HATPR) .....19.95

#### DTPH-3 with 3-Way Pan Head

DTPH-3 Champaign Gold (HATPDCG).....21.95  
 DTPH-3 Titanium Gray (HATPDTG).....21.95  
 DTPH-3 Blue (HATPDBL) .....21.95  
 DTPH-3 Purple (HATPDP) .....21.95  
 DTPH-3 Pink (HATPDPO) .....21.95  
 DTPH-3 Red (HATPDR).....21.95

### CT-8 Compact 8-Section Tripod

Hakuba's CT-8 is available in blue, champaign, gold, green and black and features a 3-way pan head. Weighing only 17.6 oz. the tripod's folded length is 10.2" and it's maximum extended height is 40.2".



CT-8 Black (HACT8B) .....24.95  
 CT-8 Blue (HACT8BL) .....24.95  
 CT-8 Green (HACT8G) ..... 24.95  
 CT-8 champaign Gold (HACT8GR) .....24.95

### HG Series Carbon Fiber Tripods with Case & Stone Bag

Hakuba has designed the HG-503MX and HG-504MX with superior magnesium and carbon fiber construction. These tripods are equipped with a reversible, split center column, rubber feet and have durable scratch resistant Urethane leg covers. In order to obtain the maximum strength and lightness, the yoke is constructed of magnesium alloy. The HG-503MX extends from 11" to 70" and folds to 26.8". The HG-504MX extends from 9.8" to 63" and folds to 22". Both weigh under 4 lbs.



#### HG-503MX Carbon Fiber 3-Section Tripod with Case & Stone Bag

HAHG503MX.....289.95

#### HG-504MX Carbon Fiber 4-Section Tripod with Case & Stone Bag

HAHG504MX.....299.95



For Any Inquiries Regarding Your Order, Call Our Customer Service:  
 (800) 221-5743 • (212) 239-7765 • FAX: (800) 947-2215 • (212) 239-7549

# IMPACT

## TRIPODS

Impact tripods are set to meet every possible photo need. Manufactured in the Orient with the original German engineering, combining the latest in modern technology and quality craftsmanship for the imaging needs of today. All Impact tripods are covered by a 5-year warranty.

### **700 Tripod (IM700)**

4-section tripod with center brace and 3-way panhead with quick release and bubble level. Minimum height is 15.75" maximum height is 39.5" and 48.25" with sliding center column extended. Folds to a compact 16.75". Supports up to 4 lbs., weighs 30 oz. ....29.95

### **800 Tripod (IM800)**

Same as the 700 except minimum height is 18", maximum height is 40.5" and 52" with sliding center column extended. Folds to a compact 19.25". Supports up to 4 lbs., weighs 30 oz. ..24.95

### **807 Tripod (IM807)**

3-section tripod with center brace and 3-way panhead with quick release and bubble level. Geared center column with friction control. Minimum height is 19", maximum height is 50.7". Folds to a compact 20". Supports up to 6 lbs., weighs 2.6 lbs. ....29.95

### **820 Tripod (IM820)**

Same as the 807 except minimum height is 21.5", maximum height is 60.75". Folded length is 22". Supports up to 8 lbs., weighs 3.2lbs .....49.95

### **920 Tripod (IM920)**

Same as the 820 except minimum height is 23.5", maximum height is 59". Folded length is 25". Supports up to 8 lbs., weighs 4.2lbs .....79.95

### **2203L Tripod (IM2203L)**

The 2203 includes a wonderfully precise 3-way head and exceptional low-angle shooting abilities. Geared center column. Minimum height is 9.8", maximum height is 39". Folded length is 19". Supports up to 10 lbs., weighs 2.8 lbs .....69.95

### **2603 Tripod (IM2603)**

A well-made tripod at an attractive price, the 2603 operates efficiently with lever locks that are easy on one's hands. The adjustable-friction geared center column allows the mounting of a tripod head on its bottom for low-angle work. Minimum height is 23.8", maximum height is 61.8". Folded length is 25". Supports up to 13 lbs., weighs 4.6 lbs .....79.95



### **CX2000 Table-Top Tripod (IMCX2000)**

A 3-leg section table-top tripod with a 2-way 180° ball-head. 1/4 - 20" mounting stud. 4.9" minimum operating height, 9.25" maximum height, folds to 6", weighs 3 oz .....9.95

### **CX3000 Table-Top Tripod (IMCX3000)**

The ideal tool for table-top, low-angle, and close-up shots. Nicely designed in a two-tone chrome finish, this tripod will give steady support at all times, and will nicely fit into a camera bag. The legs come tipped with rubber non-slip tips. 9.25" maximum height, folds to 6", weighs 3 oz. ....13.95

### **BS19 Table-Top Tripod (IMBS19)**

A 3-leg section table-top tripod with a 2-way 360° ball-head. 1/4 - 20" mounting stud. 5.5" minimum operating height, 9.8" maximum height, folds to 6.3", weighs 3.9 oz ..19.95

TRIPODS

463

# LINHOF

## TRIPODS

TRIPODS

464

Only a solid camera support assures maximum image sharpness, that's why Linhof offers the Universal Tripods for loads up to 26.5 lbs. as well as tripod heads and accessories. The tripods are made to the same exacting quality standards and materials as Linhof cameras. They are respected by demanding photographers the world over, for their outstanding quality, superior design, immaculate finish, maximum stability and freedom from vibration. Oversized control and locking levers are just some of the distinguishing fixtures of Linhof tripods. Lightweight construction techniques and the use of only the finest materials, combined with hard anodizing of all tripod legs and columns, assure absolutely corrosion-proof surfaces and a long service life.

### 003414 Lightweight Pro Tripod (LITLW3S)

3-section tripod with detachable umbrella struts, rapid clamp locks and 35mm diam. sliding centerpost. Extends to 75", folds down to 26". Has a built-in spirit level, convertible feet, metal spikes/rubber tips, and large dual-thread top plate with 1/4 and 3/8" camera screw. Weighs 5.3 lbs.....**349.50**

### 003317 Twin Shank Pro Tripod Expert (LITE)

2-section tripod with large leg mount collar and twin shank upper leg sections. Extends to 73" folds to 32". Removable umbrella struts, convertible feet: rubber pads /metal spikes. Sliding, reversible center-post with large dual-thread top plate 1/4" and 3/8". Extremely rigid, lightweight tripod for professional requirements. Load capacity 27 lb., weighs 6.5 lb .....**699.95**

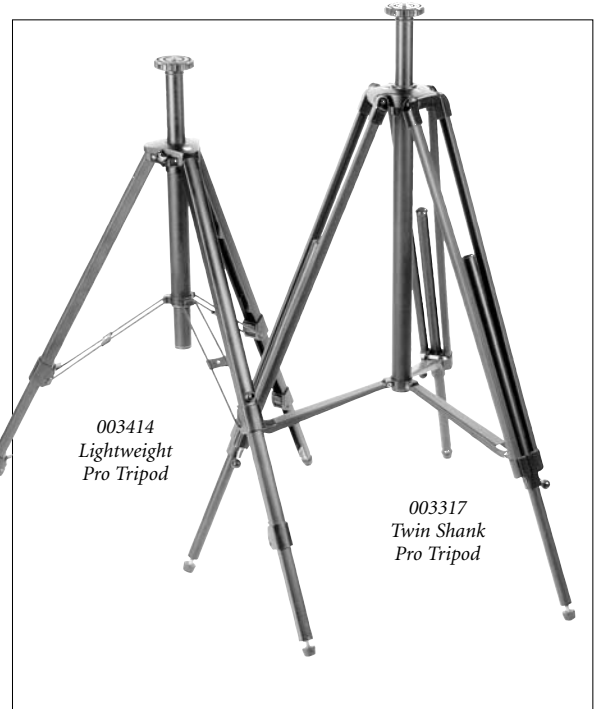

### UNIVERSAL TRIPODS

| Model                 | 003414           | 003317         |
|-----------------------|------------------|----------------|
| Load Capacity         | 13 lbs.          | 26.5 lbs.      |
| Maximum Extension     | 75"              | 73"            |
| Minimum Usable Height | 0                | 0              |
| Leg Sections          | 3                | 2              |
| Center Column Section | 2                | 2              |
| Folded Length         | 25.6" (65cm)     | 32" (81cm)     |
| Weight                | 5.3 lbs. (2.4kg) | 6.6 lbs. (3kg) |

## LEVELLING HEADS



003663  
3-Way  
Levelling  
Head I

003664  
Large 1/4"  
Levelling  
Head

### 003663 3-Way Levelling Head I (LILH1)

Combines flexibility and light weight with extremely compact size and maximum stability. Eccentric locking levers positively secure the camera at any angle. Holds camera with telephoto lenses and view cameras up to 5x7. Especially suitable for precise camera adjustment in copy work. Tilt motions and pan rotation lock separately. 77mm diameter top plate with 1/4" and 3/8" camera screws. 77mm diameter base plate. Weighs 32 oz.....**658.50**

### 003659 Large 3/8" Levelling Head (LILH38L)

Heavy duty head for smooth omni-directional 15° levelling and vibration-free support of heavier cameras, powerful tele lenses and other optical instruments. 1/4" tripod thread and camera screw. 77mm base and top plate. Maximum load capacity 22 lbs. Weighs 16 oz .....**414.95**

### 003664 Large 1/4" Levelling Head (LILH.25L)

Same as the above Levelling Head with a 1/4" tripod thread and camera screw .....**357.95**



# LINHOF

## LEVELLING HEADS / BALL HEADS

Linhof heads firmly lock in any position. Whether large format, medium format or 35mm cameras, Linhof offers the perfect head. Both the Levelling Heads and Ball Heads are of all-metal design with extreme load capacities.

Universal Ballheads are Linhof's smallest heads supporting up to 5 lbs for the Universal 01 and 10 lbs for the Universal 1. These heads have no tension control. They have a reversible 1/4 - 3/8" thread top plate and have a 3/8" threaded socket with a 1/4" reducing bushing.

Built for decades of professional use, heavy-duty Profi Ballheads have tension control and separate locks for the pan and ball. They have fully calibrated bases and support heavy equipment. Profi heads are available with either the 1/4 - 3/8" thread top plates or with the Linhof Quickfix quick release system that is auto locking and has a non-twist surface camera plate. Profi II Ballheads weighs 1 lb. without Quickfix, and 1.7 lb with it, and support systems up to 18 lbs. The Profi III weighs 3 lb without Quickfix or 3.7 lb with it, and supports systems in the mid 20 lb. range.

### Universal-Ballhead 01 (LIPBH01)

The smallest in the Linhof range, ideal for compact 35mm cameras. Positive tilt lock with uniform friction over entire tilt range. 42mm diameter top plate, 1/4" camera screw. 3.5 lb. load capacity. 40mm base plate, 1/4" tripod thread. It is 3.1" high and weighs 9.5 oz.....**102.50**

### Universal-Ballhead I (LIPBH1)

Handy ballhead for 35 mm and medium format cameras. Load capacity is 7.5 lbs., continuous friction. Pan movements separately locked. Dual-thread 42mm diameter top plate, 49mm diameter base plate. Weighs 10 oz., 3.7" high.....**124.95**

### Profi Ballhead II (LIBHP242)

Medium-sized precision ballhead for professional use. Handles loads up to 17.5 lbs. Calibrated friction control, oversized locking knobs for secure positioning without creating camera shifts. Pan movements separately locked. Dual-thread 42 mm diameter top plate, 63mm diameter base plate. Weighs 1 lb., 4.3" high.....**274.95**

### Profi Ballhead II Q (LIBHP2QF1)

Same as Profi Ballhead II, however, instead of dual-thread top plate is equipped with built-in Quickfix I Quick Release and 2.8 x 2" quick release plate. It weighs 26 oz. and is 4.5" high. Additional quick-change camera plates (003875) are available for working with more than one camera.....**319.95**

### Profi Ballhead III (LIBHP377)

Heavy duty precision ballhead for professional use. Load capacity is 22 lbs. Calibrated friction control, oversized locking knobs for secure positioning without creating camera shifts. Pan movements separately locked. Dual-thread 77mm diameter top plate, 80mm diameter base plate. Weighs 2 lb., 4.8" high.....**429.95**

### Profi Ballhead III Q (LIBHP3QF2)

Same as Profi Ballhead III, however, instead of dual-thread top plate is equipped with built-in Quickfix II Quick Release and 3.9 x 2" quick release plate. It weighs 2.4 lb. and is 5" high. Additional quick-change camera plates (LIQRPQF2) are available when working with more than one camera.....**548.95**

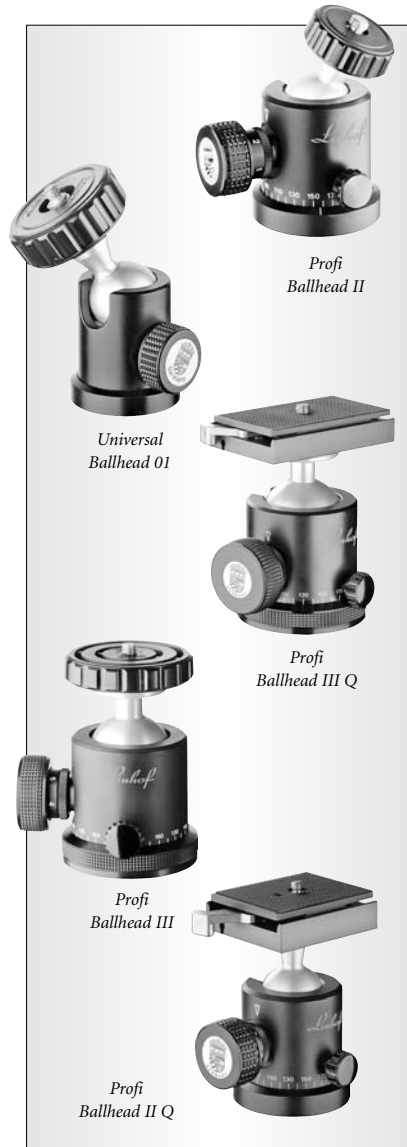

TRIPODS

465

### LEVELLING HEADS / BALL HEADS SPECIFICATIONS

| Ball Heads      | Load Capacity | Height | Weight   |
|-----------------|---------------|--------|----------|
| 003681          | 5 lbs.        | 3.1"   | 10 oz.   |
| 003677          | 10 lbs.       | 3.7"   | 2.4 lbs. |
| 003676          | 17.6 lbs.     | 4.2"   | 1.2 lbs. |
| 003679          | 17.6 lbs.     | 4.3"   | 1.6 lbs. |
| 003675/003680   | 22 lbs.       | 5"     | 2.8 lbs. |
| Levelling Heads | Load Capacity | Height | Weight   |
| 003659/003664   | 22 lbs.       | 2.7"   | 1 lb.    |
| 003663          | 11 lbs.       | 3.5"   | 2 lbs.   |

ORDER & INFO. (212) 502-6340 • FAX: (212) 239-7770 (800) 947-7008  
**1-800-290-6750 • www.bhphotovideo.com**



# MAJESTIC

## TRIPODS & GEARHEADS

TRIPODS

466

For more than 50 years, Majestic tripods and gearheads have meant the ultimate in heavy-duty support for demanding professionals. Majestic tripods are hand-built from aluminum castings and tubing for maximum strength and portability. Steel or brass is incorporated at critical wear points to assure the long, useful life for which Majestic has always been famous. All models feature a foldaway crank-operated rack & pinion center column for quick and positive camera height positioning. Non-skid, rubber feet make certain the tripod stays put. Select factory installed extension legs and/or extension column options to fit your shooting height needs; an accessory sidearm is available for those really low shots. Finally, choose between a 1½" post mount or the universal 3/8" mounting screw to the head of your choice.

### 6500 Series—

For most professional photographic applications. Securely holds cameras weighing up to 30 lbs. The 6500 features a traditional design for setting the legs with each double-braced leg individually locked into a rigid position. Adjustable preset leg stops assure quick and repeatable setups. The perfect tripod for those big location jobs.

### 7500 Series—

For maximum leg stability to handle cameras weighing up to 40 lbs. Six long leg braces placed well below the leg pivot point virtually eliminate any leg movement to assure rock steady performance. The sliding center brace sets all legs simultaneously, allowing the 7500 to be opened with one hand. Add casters to the 7500 for the most convenient, yet stable support system available. Ideal for studio or field applications.

### FEATURES

- ◆ Rugged aluminum body castings
- ◆ Rack and pinion "Quick-Lift" column drive
- ◆ Spring loaded safety bracket
- ◆ Full-size column locking knob
- ◆ Solid aluminum fold-away crank handle
- ◆ Thick wall anodized aluminum legs
- ◆ Two heavy-duty braces for each leg
- ◆ Adjustable, preset leg stops
- ◆ Positive individual leg locks
- ◆ Oversized rubber leg tips

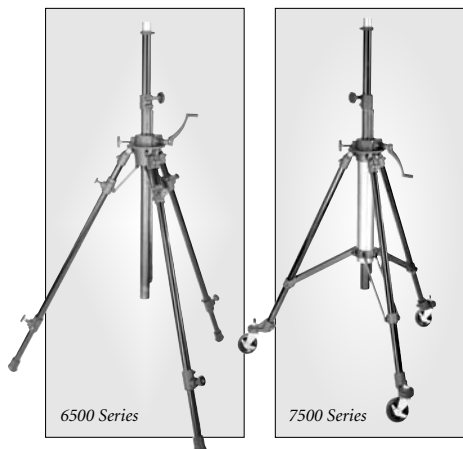

### 6500 SERIES TRIPODS

| Catalog Number  | Model | Tripod Mount | Maximum Height | Minimum Height | Folded Length | Weight  | Price  |
|-----------------|-------|--------------|----------------|----------------|---------------|---------|--------|
| 850-01 (MA5001) | 6501  | 3/8" screw   | 49"            | 30"            | 33"           | 6.5 lb. | 322.95 |
| 850-03 (MA5003) | 6502  | 3/8" screw   | 71"            | 32"            | 35"           | 8.5 lb. | 364.95 |
| 850-05 (MA5005) | 6503  | 3/8" screw   | 69"            | 31"            | 34"           | 7.5 lb. | 416.50 |
| 850-07 (MA5007) | 6504  | 3/8" screw   | 91"            | 33"            | 36"           | 9.5 lb. | 458.95 |
| 852-01 (MA5201) | 6521  | 1½" post     | 51"            | 32"            | 35"           | 6.5 lb. | 322.95 |
| 852-03 (MA5203) | 6522  | 1½" post     | 72"            | 34"            | 37"           | 8.5 lb. | 364.95 |
| 852-05 (MA5205) | 6523  | 1½" post     | 72"            | 33"            | 36"           | 7.5 lb. | 416.50 |
| 852-07 (MA5207) | 6524  | 1½" post     | 93"            | 35"            | 38"           | 9.5 lb. | 458.95 |

### 7500 SERIES TRIPODS

| Catalog Number  | Model | Tripod Mount | Maximum Height | Minimum Height | Folded Length | Weight | Price  |
|-----------------|-------|--------------|----------------|----------------|---------------|--------|--------|
| 850-21 (MA5021) | 7501  | 3/8" screw   | 49"            | 30"            | 33"           | 7 lb.  | 382.50 |
| 850-23 (MA5023) | 7502  | 3/8" screw   | 71"            | 32"            | 35"           | 9 lb.  | 433.50 |
| 850-25 (MA5025) | 7503  | 3/8" screw   | 69"            | 31"            | 34"           | 8 lb.  | 475.95 |
| 850-27 (MA5027) | 7504  | 3/8" screw   | 91"            | 33"            | 36"           | 10 lb. | 526.95 |
| 850-41 (MA5041) | 7505  | 3/8" screw   | 53"            | 34"            | 37"           | 16 lb. | 433.50 |
| 850-43 (MA5043) | 7506  | 3/8" screw   | 74"            | 36"            | 39"           | 18 lb. | 475.95 |
| 852-21 (MA5221) | 7521  | 1½" post     | 51"            | 32"            | 35"           | 7 lb.  | 382.50 |
| 852-23 (MA5223) | 7522  | 1½" post     | 72"            | 34"            | 37"           | 9 lb.  | 433.50 |
| 852-25 (MA5225) | 7523  | 1½" post     | 72"            | 34"            | 37"           | 9 lb.  | 475.95 |
| 852-27 (MA5227) | 7524  | 1½" post     | 93"            | 35"            | 38"           | 10 lb. | 526.95 |
| 852-41 (MA5241) | 7525  | 1½" post     | 55"            | 36"            | 39"           | 16 lb. | 433.50 |
| 852-43 (MA5243) | 7526  | 1½" post     | 76"            | 38"            | 41"           | 18 lb. | 475.95 |



# MAJESTIC

## TRIPODS & GEARHEADS

Majestic gearheads are available to fit three different tripod mounts: standard 3/8" screw mount, 1/2" Majestic post mount and 1 7/8" post mount.

A choice of four interchangeable camera platforms are offered to properly support any size camera. Both 1/4" and 3/8" camera mounting screws are included with each gearhead.

| Catalog Number  | Model | Tripod Mount      | Platform     | Price  |
|-----------------|-------|-------------------|--------------|--------|
| 810-01 (MA1001) | 1001  | 3/8" screw mount  | 6 x 7"       | 279.95 |
| 810-03 (MA1003) | 1003  | 3/8" screw mount  | 6 x 4 1/2"   | 279.95 |
| 810-05 (MA1005) | 1005  | 3/8" screw mount  | 3 x 3 3/4"   | 279.95 |
| 810-07 (MA1007) | 1007  | 3/8" screw mount  | 4 1/2" round | 279.95 |
| 812-01 (MA1201) | 1201  | 1 1/2" post mount | 6 x 7"       | 269.95 |
| 812-03 (MA1203) | 1203  | 1 1/2" post mount | 6 x 4 1/2"   | 269.95 |
| 812-05 (MA1205) | 1205  | 1 1/2" post mount | 3 x 3 3/4"   | 269.95 |
| 812-07 (MA1207) | 1207  | 1 1/2" post mount | 4 1/2" round | 269.95 |
| 819-01 (MA1901) | 1901  | 1 7/8" post mount | 6 x 7"       | 269.95 |
| 819-03 (MA1903) | 1903  | 1 7/8" post mount | 6 x 4 1/2"   | 269.95 |
| 819-05 (MA1905) | 1905  | 1 7/8" post mount | 3 x 3 3/4"   | 269.95 |
| 819-07 (MA1907) | 1907  | 1 7/8" post mount | 4 1/2" round | 269.95 |

Designed for cameras weighing up to 35 lbs., the camera platform tilts forward 90° and back 30° by simply turning the crank on the rear of the gearhead. Smooth meshing metal worm gearing holds the camera securely in place at any position. The platform can also be manually tilted up to 15° left or right. All heads can be rotated 360° on the tripod mount with the camera attached, making the Majestic Gearhead the most versatile heavy support system available.

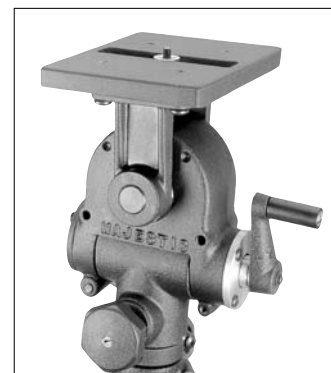

TRIPODS

467

# KAISER

Kaiser ball heads are among the best in performance and value! Ranging from very small ball heads (2" high) to heavy-duty professional models. The two largest have a tension control as well as pan and ball locks. Kaiser also makes small ball heads and tilt mounts for lighting and quick releases.

**206013 Small Ballhead (KABHS):** For lighter duty applications. Single locking knob for ball and pan, 1/4"-20 size camera screw, 3/8"-16 tripod socket with 1/4"-20 adapter. It has a load capacity of 2.2 lbs., a height of 2", and weighs 1.6 oz.....**29.95**

**206018 Medium Ballhead (KABHM):** Slightly larger than the above ballhead. It has a load capacity of 4.4 lbs., a height of 2.6", and weighs 3.9 oz.....**33.50**

**206017 Small Pro Ballhead with Independent Panning Lock (KABHPS):** A lightweight professional ball head, sitting on a fluid system panoramic base, with a separate locking knob for the panning bed. With 1/4"-20 size camera screw, 3/8"-16 tripod screw with 1/4"-20 adapter. It has a load capacity of 9 lbs., a height of 3.8", and weighs 10.6 oz.....**69.95**

**206011 Medium Pro Ballhead with Independent Panning Lock (KABHPM):** With reversible 1/4"-20 and 3/8"-16 camera screw, 3/8"-16 tripod screw with 1/4"-20 adapter. This medium weight professional ball head has a panoramic base with 2° divisions, a large locking knob, an adjustable friction brake for fine setting and a separate panning locking knob. It has a load capacity of 18 lbs., a height of 4.6", and weighs 22.9 oz.....**199.95**

**206012 Large Pro Ballhead with Independent Panning Lock (KABHPL):** Heavyweight Professional ballhead. It has a load capacity of 22 lbs., a height of 5.6", and weighs 43 oz.....**239.95**

**206014 Large Pro Ballhead with Quick-Release Connector (KABHPLQR):** Same as the above 206012 Ballhead, but it has a built-in Pro Quick Release with two built-in bubble levels, and includes 6026 camera plate. It has a load capacity of 22 lbs., a height of 5.9", and weighs 51.5 oz.....**324.95**



**Small Quick Release Adapter with Plate (KAQRS) .....26.95**

**Large Quick Release Adapter with Plate (KAQL).....36.95**

**ORDER & INFO. (212) 502-6340 • FAX: (212) 239-7770 (800) 947-7008  
1-800-290-6750 • www.bhphotovideo.com**





# MANFROTTO

## DIGI TRIPODS

TRIPODS

468

Manfrotto offers one of the widest range of tripods, heads and accessories for digital applications around the world. Their products are packed with well thought out features that make each piece of equipment easy to use and as versatile as possible. All tripods are carefully designed to optimize the critical balance between weight for portability, maximum and minimum height for low level as well as high level camera shooting, loading capacity and sturdiness. All models are engineered for reliability, vibration resistance, and long life. The wide choice of precision-built heads makes it easy to exactly match the need. Tripod heads are interchangeable for maximum versatility and economy. Heads and accessories are universal. You can be sure of outstanding images, whether in the studio or on location, with Manfrotto's well-proven equipment to support you.

### 709BR Digi Tabletop (BO709BR)

Lightweight and compact, these 4-section table-top tripods are perfect for a wide range of digital photographic applications. Developed to maximize the superior imaging capabilities and versatility of today's compact digital cameras, the 709 series Digi-Table Tops sets up in seconds to form an exceptionally stable shooting platform that can be used virtually anywhere, indoors or out. It sports a handsome bright aluminum finish and comes complete with a silky-smooth Manfrotto Mini Ball Head providing 360° pan and ± 90° tilt. A convenient belt-loop carrying pouch is also available for it.....**30.95**

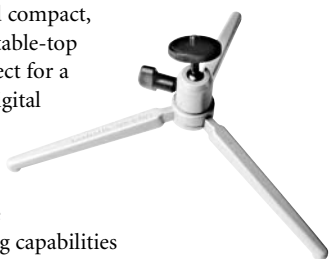

**709B Digi Table Top (BO709B):**  
Same as above in Black finish .....**30.95**

### 714B Digi Tripod (BO714B)

The most compact, full-size tripod in the Manfrotto range, the 714B is ideal for compact digital cameras. Although compact, Manfrotto was careful not to compromise stability for size and weight reduction. The incredibly short folded length of just over 17" was achieved with two engineering breakthroughs. First, the leg pivot was re-designed with a unique single hinge allowing the leg to fold shorter than conventional designs. Secondly, an integral ballhead is recessed into the main shoulder casting for transport.

This compact ballhead allows a preset but adjustable tension to be set so that all you have to do is point and shoot. No more locking off handles before you take that shot! This adjustment is done with a handle found on the bottom of the column, set it for your camera and forget it, then just aim and shoot. If you want to lock it down, just turn the handle further and it will lock off the head. The 714B also features quick-action leg locks for fast set-up and breakdown, and an innovative three faceted center column design prevents any column rotation. Includes a bag that sports twin shoulder straps for backpack-style carrying .....**84.95**



**714SHB Digi Tripod:** Same as above with a shorter center column and folded length of just under 14" (BO714SHB) .....**84.95**

### 718B/718SHB Digi-Tripods

The compact 718B and 718SHB have a built-in hybrid video/photo 3-way head. The 718B has longer leg sections for greater extended height (48.5"). The both have a "dovetail" quick release camera plate (which can be locked in place one-handed), separate pan and tilt locks, and a short pan/tilt bar for more ergonomic use while panning or tracking moving subjects. Like the 714SHB, the 718SHB is an extremely compact 4-section tripod with a short 15.9" folded length that will fit in your luggage with space left over.

On both 718B and 718SHB, the leg pivot system uses a unique single hinge design in aluminum which both keeps the cross section smaller and allows the leg to fold shorter than conventional tripods. The tripods are built with "D" profile tubular legs for extra torsional rigidity and quick flip leg locks for ease and speed of set-up. A quick action lever also blocks the reversible center column extension. The 718B and 718SHB come complete with a carrying bag with twin shoulder straps for backpack style carrying.

**718B Digi Tripod (BO718B).....94.95**  
**718SHB Compact Digi Tripod (BO718SHB).....94.95**



# MANFROTTO

## DIGI TRIPODS

TRIPODS

469

### 724B Digi-Tripod (BO724B)

Designed for today's digital and conventional cameras, this lightweight and compact tripod offers all the rock steady support necessary for high quality imaging. Handsome black anodized legs and black painted castings reveal a tripod with features and an unbeatable price.

The Digi 724B is a lightweight marvel that can meet any shooting need. It includes an aluminum ball head with a single "ratchet" locking lever as well as quick-action leg locks for fast set-up and breakdown. Ideal for fitting into luggage, four section tripod legs permit a folded length of just 19". Once on location, the 724B extends to 5' 8". It weighs 3-lbs, and can support digital cameras up to 7.7 lbs. In addition, the innovative three faceted center column design prevents any column rotation and is reversible for low-angle shots. A carry bag that sports twin shoulder straps for backpack-style carrying is also included.....**98.95**



### 728B Digi-Tripod (BO728B)

Ideally suited for compact digital cameras, the 728B is a 4-section tripod that provides a stable platform for rock steady shots. Lightweight and compact, the legs are constructed of sturdy multi-faceted tubular aluminum that features new quick flip lever leg locks for fast set-up and breakdown. The shoulder of the tripod is made of cast aluminum to increase rigidity, and it incorporates a unique single hinge design which allows for a more compact leg section when folded. The center column is also reversible for low-angle shots, and the integrated 3-way head is also made of cast aluminum and features a quick release plate. Pan and tilt movements are extremely smooth to allow for clean video pans and tilts, and a carry bag that sports twin shoulder straps for backpack-style carrying is also included .....**112.95**



Each of the Manfrotto Digi Tripods include a super convenient carry bag that sports twin shoulder straps for backpack-style carrying.

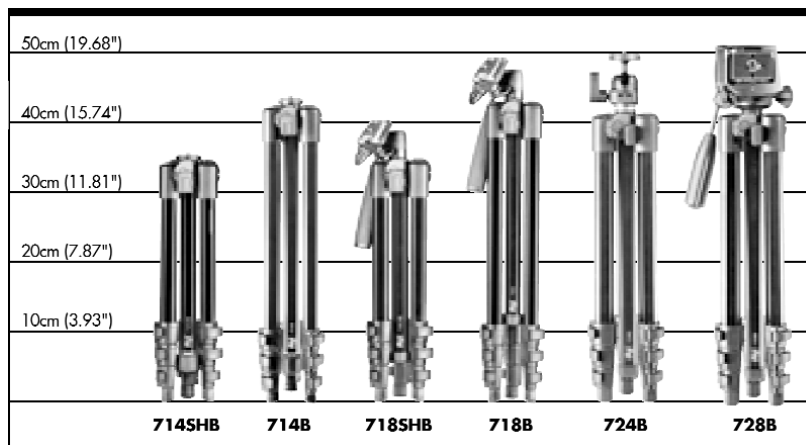

|         | Maximum Load | Maximum Height | Maximum Height with Column | Minimum Height | Closed Length | Weight   |
|---------|--------------|----------------|----------------------------|----------------|---------------|----------|
| 709B/BR | 4.5 lbs      | 3.54"          | N/A                        | N/A            | 6.69"         | .2 lbs   |
| 714B    | 5.5 lbs      | 64.2"          | 52.4"                      | 16"            | 17.3"         | 2.5 lbs  |
| 714SHB  | 5.5 lbs      | 38.3"          | 47.8"                      | 12.8"          | 13.8"         | 2.22 lbs |
| 718B    | 5.5 lbs      | 54.9"          | 65.5"                      | 18.7"          | 19.3"         | 3.09 lbs |
| 718SHB  | 5.5 lbs      | 41.2"          | 48.5"                      | 15.6"          | 15.9"         | 2.74 lbs |
| 724B    | 7.7 lbs      | 52"            | 64.5"                      | 18.5"          | 20"           | 3.1 lbs  |
| 728B    | 7.7 lbs      | 52.4"          | 64.8"                      | 19.1"          | 20.3"         | 3.86 lbs |

ORDER & INFO. (212) 502-6340 • FAX: (212) 239-7770 (800) 947-7008  
**1-800-290-6750 • www.bhphotovideo.com**



# MANFROTTO

## NEOTEC

TRIPODS

470

*You're on an outdoor shoot running up against a tight deadline to get all the images you need; you've got no assistants getting your equipment ready for you; if you shoot handheld, you're going to be forced to select from a dwindling number of sharp photos as well as spend more time in post-production, but getting your tripod open, set up and levelled is going to take up precious moments of the remaining perfect light... sound familiar? So what would you give to have equipment that was on your side in crucial moments like that? The NeoTec tripod is awesomely fast and easy to use, with the most innovative rapid opening and closing mechanism available today - just pull each leg downwards to open and automatically lock it in any position - with no screws, knobs or levers to tighten or loosen. Then to fold it back up again, press the mechanism release button and push the leg closed. All in a matter of seconds.*

- ◆ NeoTec rapid opening and closing mechanism
- ◆ Two-part center column switches between normal and low-angle work, without forcing you to remove camera and head every time you need to change position
- ◆ Leg lock release button for closing the tripod or shortening each leg for perfect positioning
- ◆ Patented top casting allows horizontal setting of the center column for unusual angles and macro work
- ◆ Four set leg angle (25°, 43°, 73° and 90°) positions for a solid footing at any height
- ◆ Includes a detachable carrying handle, which can also be used to support a counterweight
- ◆ Waterproof up to 18" as the bottom leg section is sealed



**458B NeoTec Pro Photo Tripod (BO458B)**  
3-section tripod weighs 5.3 lbs., supports up to 17.6 lbs., extends to 61.4", minimum height is 3.9", closes to 25.2" .....**299.95**



Pull each leg downwards to open and it automatically locks in any position -with no screws, knobs or levers to tighten or loosen.



Press the mechanism release button and push the leg upwards. Release at any intermediate point to lock the leg, or push it all the way up to close.

Manfrotto's design team consciously ignored how most tripods work and thought instead about how a tripod should work, beginning with how easily and quickly it should be set up or how effortlessly it should close. At the heart of NeoTec lies an innovative mechanism which, hidden safely inside the leg and without any external levers or knobs, pushes outwards on the tubing to lock the leg in place at any extension. The mechanism exerts more locking power the heavier the weight pushing down on it from above. Beyond the extreme ease of use it offers you, NeoTec is also a workhorse tool for professional photographers - offering stable and strong support that can take the strain of constant use and safely bear the load of professional camera equipment. But it doesn't stop there, it also includes a built-in low angle adapter for the times when the center column length gets in your way, and a convenient handle for more comfortable carrying.



For Any Inquiries Regarding Your Order, Call Our Customer Service:  
(800) 221-5743 • (212) 239-7765 • FAX: (800) 947-2215 • (212) 239-7549

# MANFROTTO

## TRIPODS

### 3001N

#### Lightweight Tripod

Lightweight, compact and sturdy, this tripod is ideal for people on the move. Features 4-position leg angle settings (25°, 43°, 73°, 90°) for ease of leveling. A variable height, reversible center column with innovative three-faceted design eliminates column rotation. Adjustable 3-section telescopic legs come with sure grip wing knob locks for secure locking. The optional 190LLA Low Angle Adapter stores on the bottom of the center column for convenience. Maximum height is 46.5" and 57" with column extended. Folds to a compact 21". Weighs 3.7 lbs. and supports up to 11 lbs.

BO3001N.....**89.95**  
BO3001BN (Black).....**92.95**

### 3001D

#### Lightweight Tripod

Same as 3001N plus speedy setup with added security when it's quick-action, lever-type legs lock into position. It also has a low-angle adapter built into the center column for ground level shots. Minimum height is 3.1". Includes foam rubber leg warmers on two legs to protect your hands in cold weather, and your body when carrying the tripod on your shoulder.

BO3001D.....**114.95**  
BO3001BD (Black).....**110.95**

### 3001 PRO

#### Lightweight Tripod

Even more versatile, this tripod has an easily removed center column that can be used horizontally or vertically. The column converts to an arm in seconds, providing tabletop and overhead camera positions that are impossible with standard tripods. The center column design also allows you to leave the head mounted when switching between low angle and normal shooting. Minimum height is 8.3". Tripod includes foam rubber leg warmers on two legs, plus has a built-in spirit level.

BO3001P.....**124.95**  
BO3001PB (Black).....**122.95**



### 3011N

#### Basic Tripod

Lightweight, sturdy, portable and easy to handle, this basic tripod is one of the easiest to handle. Designed for SLR-type film and digital cameras, it offers a long reversible center column for extra high adjustment with an innovative three faceted design that eliminates the problem of column rotation. It features a single-position leg spread, and leg collars with double wing locking knob. Maximum height is 54" (71.3" with center column extended). Minimum height is 22" and it folds to 24". Weighs 4.9 lbs. and can support up to 13 lbs.

BO3011N.....**104.95**  
BO3011BN (Black).....**106.95**

### 3021N

#### Professional Tripod

Features rapid action lever leg locks with just 45° movement for fast setup and added security, a variable height and reversible center column with three-faceted design that eliminates column rotation. It features 4-position leg angle settings (26°, 45°, 75°, 90°) and a low-angle adapter built into the center column for low level shots — only 3.1" from ground level. Includes foam rubber leg warmers on two legs to protect your hands in cold weather, and your body when carrying the tripod on your shoulder. Maximum height is 53" (70" with center column extended). Folds to 24". Weighs 5.1 lbs. and can support up to 15.4 lbs.

BO3021N.....**139.95**  
BO3021BN.....**136.95**

### 3021 PRO

#### Professional Tripod

Same as the 3021N but even more versatile! With a center column designed as an alternative to the low-angle adapter, the head can be left mounted to the column when switching between low angle and normal shooting. In addition, the easily removeable center column doubles as a horizontal arm. Not only does this allow the camera to be offset from leg position, but it provides the simplest way possible to shoot from directly overhead. The top section of the center column is detached by simply unscrewing the knob at the bottom of the column. Includes foam rubber leg warmers on two legs to protect your hands and body.

BO3021P.....**149.95**  
BO3021PB.....**146.95**

TRIPODS

471

ORDER & INFO. (212) 502-6340 • FAX: (212) 239-7770 (800) 947-7008  
**1-800-290-6750 • www.bhphotovideo.com**



# MANFROTTO

## TRIPODS

TRIPODS

472

### 190MF & 055MF MagFiber Tripods

The revolutionary MagFiber tripods combine the strength of magnesium and carbon fiber. Each leg is crafted from carbon fiber using an exclusive process. Under intense pressure, extra long carbon fibers are combined with resin to produce a stronger tube that absorbs more vibration than any other tripod in its class; all with a wall thickness of only 1.2mm. Manfrotto engineers also replaced all aluminum tripod components with die-cast magnesium. This switch represents a lateral move in sturdiness yet a substantial gain in strength and reduction of weight by 30% over similar sized aluminum models.

- ◆ Carbon fiber three-faced tubes for the tripod legs; aluminum and nylon polymer center column. Magnesium die-casting (30% lighter than aluminum) for all tripod parts and stainless steel nuts and bolts
- ◆ Quick-action adjustable leg lever locks instantly secure leg extensions firmly in place with no slippage or rotation
- ◆ Push buttons to operate leg angles to offer four angle of inclination
- ◆ Center column converts in seconds to a lateral arm to provide table-top and overhead camera positions.
- ◆ Two-part center column switches between normal and low-angle work without having to remove the camera and head everytime you need to change position.
- ◆ Built-in low-angle adapter (easily detaches without any tool) forms the top section of the center column. This enables the head to be left mounted on the center column when switching between low-angle and normal shooting positions.
- ◆ Supplied hand padded carrying strap doubles as a hook to hang weight and increase stability during extreme wind conditions.



**190MF3 (BO190MF3):** 3-section tripod weighs 3.5 lbs., supports up to 8.8 lbs., extends to 56", minimum height is 4.3", closes to 22" .....**249.95**  
**190MF4 (BO190MF4):** 4-section tripod weighs 3.5 lbs., supports up to 8.8 lbs., extends to 51.6", minimum height is 4.3", closes to 18.1" .....**264.95**

A 'beefier' tripod to the 190MF series, the 055MF3 and 055MF4 are very light, simple to use, strong, and extremely versatile to position.

**055MF3 (BO055MF3):** 3-section tripod weighs 4.4 lbs., supports up to 15.4 lbs., extends to 66.5", minimum height is 4.3", closes to 25.2" .....**299.95**  
**055MF4 (BO055MF4):** 4-section tripod weighs 4.4 lbs., supports up to 15.4 lbs., extends to 65", minimum height is 4.3", closes to 21.3" .....**324.95**



475 Pro Geared Column Tripod

### 475 Pro Geared Column Tripod

The 475 Pro Geared Tripod offers an all aluminum construction, unrivalled stability, a unique center brace strut system, reliable quick-action leg locks, non-rollback three faceted center column, a spirit level and rubber/metal spiked feet. The 475 has a center brace system that can be operated in a symmetric or asymmetric way. This allows the best of both worlds: speed by locking the braces so that all of the legs will be spread to the same angle, or by individually setting the angle of each leg for the ultimate in tripod positioning.

To avoid annoying delays in leveling the tripod, the telescopic center braces have been designed with two "click stop" positions that allow you to easily find the same spread angle on all three legs. The 475 also incorporates Quick Action leg locks, which have an amazingly quick and secure locking range. All it takes is a 45° flip of the lever to lock and unlock each section.

**475 Chrome Tripod (BO475).....249.95    475B Black Tripod (BO475B) .....231.95**



**EQUIPMENT LEASING AVAILABLE**

# MANFROTTO

## TRIPODS

### 3046 Geared Column Tripod

Strong, sturdy and reliable, the 3046 tripod is the ideal studio tripod. The geared center column has a non roll-back feature and has a threaded 3/8" mount on the bottom of the column to allow low-angle shots. Twin shark leg design, built-in spirit level and rubber feet with retractable spikes are standard. Uses a center column strut design for added stability.

- 3046 Chrome Tripod (BO3046) .....196.95
- 3246 Black Tripod (BO3046B) .....211.95

### 3051 Geared Column Tripod

Handling everything up to 4 x 5", this tripod is capable of extremely low camera position with the platform at only 17", yet has the ability to go up and stand over 7'. Features patented automatic simultaneous release of all three legs or any individual leg. This permits the legs to be extended, the tripod levelled (spirit level included) and locked in seconds without the need for individual leg adjustment. Closing the legs is achieved by activating the same release. Also has the ability to adjust all angles individually and secure them with Manfrotto telescopic struts. Rubber feet with retractable spiked feet are standard. The geared center has a non-rollback feature.

- 3051 Chrome Tripod (BO3051) .....266.95
- 3251 Black Tripod (BO3051B) .....279.95

### 3058 Geared Column Tripod

The tallest tripod in the range, the 3058 is capable of providing a stable platform for cameras up to 44 lbs. at maximum height of almost 9' (105.2"). On the other hand this giant is also capable of a minimum height of just over 17". The geared center column is self locking. The legs are braced using telescopic struts for maximum rigidity and the ability to have individually adjustable and lockable angles. Rubber feet with retractable spiked feet and spirit level are standard equipment. Ideal for all large format cameras.

- 3058 Chrome Tripod (BO3058) .....379.95
- 3258 Black Tripod (BO3058B) .....439.95



TRIPODS  
473

### 3001/3011/3021 TRIPODS

|         | Description       | Maximum Load Capacity | Maximum Height with Extended Center Column | Minimum Height | Closed Length | Weight   |
|---------|-------------------|-----------------------|--|----------------|---------------|----------|
| 3001N/D | Anodized Aluminum | 11.1 lbs.             | 57.1"                                      | 6.7"           | 20.9"         | 3.9 lbs. |
| 3001PRO | Anodized Aluminum | 11.1 lbs.             | 57.1"                                      | 8.3"           | 22.1"         | 4.2 lbs. |
| 3011N   | Anodized Aluminum | 13.3 lbs.             | 71.3"                                      | 22.1"          | 24.1"         | 4.9 lbs. |
| 3021N   | Anodized Aluminum | 13.3 lbs.             | 70.1"                                      | 3.2"           | 24.1"         | 5.1 lbs. |
| 3021PRO | Anodized Aluminum | 13.3 lbs.             | 69.3"                                      | 4.4"           | 25.6"         | 5.3 lbs. |

### 475/3046/3051/3058 GEARED COLUMN TRIPODS

|         | Description       | Maximum Load Capacity | Maximum Height with Extended Center Column | Minimum Height | Closed Length | Weight    |
|---------|-------------------|-----------------------|--|----------------|---------------|-----------|
| 475 Pro | Aluminum          | 26.5 lbs.             | 74"  | 17"            | 31.5"         | 9.5 lbs.  |
| 3046    | Anodized Aluminum | 26.5 lbs.             | 89.4"                                      | 30.4"          | 32.3"         | 9.2 lbs.  |
| 3051    | Anodized Aluminum | 26.5 lbs.             | 85.5"                                      | 17.4"          | 37.1"         | 13.6 lbs. |
| 3058    | Anodized Aluminum | 44.1 lbs.             | 105.1"                                     | 17.4"          | 41.4"         | 17.5 lbs. |

ORDER & INFO. (212) 502-6340 • FAX: (212) 239-7770 (800) 947-7008  
1-800-290-6750 • www.bhphotovideo.com





# MANFROTTO

## MONOPODS

The monopod is an underestimated means of photographic support. It is inexpensive, light to carry, takes little space, and is easy and fast to erect. Handled correctly, it supplies all the camera support you are likely to need, even for long lenses. Just look at the press and sports photographers—these pros wouldn't bother with them if they didn't get results.

TRIPODS

474

### 676B Digi 4-Section Monopod

A simple, easy to set up black anodized aluminum monopod. The four section leg design allows it to fold up to less than 20", and it weighs less than a pound. It features rapid-action flip locks for the leg extensions, strap, and a 1/4-20" screw.

**676B Black (BO676B).....34.95**



### 684B Neotec Pro Monopod

A fast and easy monopod, with the most innovative rapid opening and closing mechanism available today. Just pull the leg downwards to open and automatically lock in any position. No screws, knobs or levers to tighten or loosen. To close it back up again, press the release button and push the leg closed in a matter of seconds. Its mechanism exerts more locking power the heavier the weight pushing down on it from above. Its "upside down" construction stops the water you're standing in from ending up inside the monopod.

**684B Black (BO684B) .....99.95**



### 681 Professional Monopod

Robust 3-section monopod with a sure rubber grip, wrist carrying strap, large 2.3" platform with plastic cover and dual 1/4-20" - 3/8" camera screw. Quick-Action lever lock system with 45° flip allows sections to be quickly set-up and adjusted.

**681 Chrome (BO681) .....47.95**

**681B Black (BO681B) .....45.95**



### 679 3-Section Monopod

3-section monopod with sure-rubber grip, quick action lock levers, large 2.3" camera/head platform and dual 1/4 - 20" and 3/8" camera screw. Quick-Action lever lock system with 45° flip allows the sections to be quickly set-up and adjusted.

**679 Chrome (BO679) ....39.95**

**679B Black (BO679B) ...37.205**



### 694/695 MagFiber Monopods

Mag Fiber monopods combine the strength of magnesium and carbon fiber. Extremely compact, they are crafted from carbon fiber using an exclusive, patented process. Under intense pressure, extra long carbon fibers are combined with resin to produce a stronger tube that absorbs more vibration - and with a wall thickness of only 1.2mm!

Manfrotto engineers also replaced all aluminum components with magnesium. They are user-friendly, with quick-action adjustable lever locks that instantly secure leg extensions in place with no slippage or rotation. They come with a wrist strap and camera platform with dual 1/4" and 3/8" camera fixing screw. The 4-section 694 has a maximum height of 65" and closes to 20.9". The 5-section 695 has a maximum height of 63" and closes to 18.1".

**694 4-Section (BO694).....161.95**

**695 5-Section (BO695).....188.95**



### 682 Self-Standing Pro Monopod

The 682 has all same features as the 681 Professional Monopod with the addition of 3 retractable legs. The three-section 682 monopod features a large 2.3" platform with a plastic cover and a dual 1/4-20" - 3/8" camera screw.

**682 Chrome (BO682) ....92.95**

**682B Black (BO682B).....82.90**



### 680 4-Section Compact Monopod

Rubber grip, quick action lock levers, large 60mm camera/head platform and 1/4 - 20" and 3/8" camera fixing screw. Closes to 20". Quick-Action lever lock system with 45° flip allows the sections to be quickly set-up and adjusted.

**680 Chrome (BO680) ....49.95**

**680B Black (BO680B).....46.95**



### 3245 Automatic 3-Section Monopod

The upper section features a grip-action release that allows the top section to be adjusted 19" up or down automatically by squeezing and releasing the grip-action handle.

The lower two sections have a twist lock action for height adjustment. Dual 1/4 - 20" and 3/8" camera fixing screw.

**3245 Chrome (BO3245).....83.95**



# MANFROTTO

## MONOPODS

TRIPODS

475

**3232 Swivel Tilt Head** (BO3232)  
Simple tilt head to allow a camera on a monopod to be turned 90° to provide either vertical or horizontal format .....**17.95**

**3229 Swivel Tilt Head with Quick Release** (BO3229)  
Same as 3232 but with quick release camera plate and secondary safety lock .....**29.95**

**3248 Shoulder Brace** (BO3248)  
Fits the top end of any monopod to give additional stability. Adjustable length with pivoting shoulder support .....**17.95**

**678 Universal Folding Base** (BO678)  
Allows the addition of a base made of three foldable high strength steel legs to the monopods 679, 680, and 681. The legs can be folded and stored inside the bottom section of the monopod ready in a few seconds when needed .....**42.50**

**3247 Monopod Belt Pouch** (BO3247)  
Worn on a belt, this easy to use pouch offers support for the base of a monopod .....**14.95**

**449SPK2 Rubber/Stainless Steel Spiked Foot** (BO449SP2)  
Reversible spiked foot supplied with a dedicated fixing tool. The spike is made of a special hard stainless steel alloy extremely resistant to corrosion. For 3449 .....**17.95**

**676SP2 Rubber/Stainless Steel Spiked Foot** (BO676SP2)  
Same as the above spiked foot, but for monopods 679 and 680 .....**17.50**

**677SP2 Rubber/Stainless Steel Spiked Foot** (BO677SP2)  
Same as above, for 681 monopod .....**16.95**

**449SC2 Suction Cup/Retractable Spike Foot** (BO449SC2)  
A rubber suction cup foot with retractable stainless steel spike. The suction cup increases the footprint of the monopod by almost 20 times, giving much greater stability when needed. The foot can be removed and replaced at will. For the 3449 .....**28.95**

**676SC2 Suction Cup/Retractable Spike Foot** (BO676SC2)  
Same as above for the 679 and 680 .....**23.95**

**3422 Monopod Support** (BO3422)  
Fixed on the monopod, adds two points of support making it stable on any surface regardless of the inclination. Allows long exposures on automatic release. Comes complete with the 3009 ballhead. Attachment - 3/8" female for monopod .....**45.00**

**3421 Long Lens Monopod Bracket** (BO3421)  
Specifically developed for use with very long lenses on monopods. Key features: friction base which enables the bracket to pan on monopod, also can be used on a tripod. Two rubber hand grips plus rubber protection to prevent damage to lens when tilted to maximum. Variable center height adjustment in three steps .....**154.95**

**3257 Spiked Foot for Monopod** (BO3257)  
Converts 679, 680 and 681 series monopods rubber foot to a spiked foot .....**14.95**

**677SP Rubber/Spiked Foot** (BO677SP)  
Rubber foot for with retractable metal spike, for monopods 679, 680 and 681 .....**16.95**

**677SC Suction Cup/Retractable Spike Foot** (BO677SC)  
A rubber suction cup foot with retractable stainless steel spike for the 681 monopod. The suction cup increases the footprint of the monopod by almost 20 times, giving much greater stability when needed. The foot can be removed and replaced at will .....**28.95**

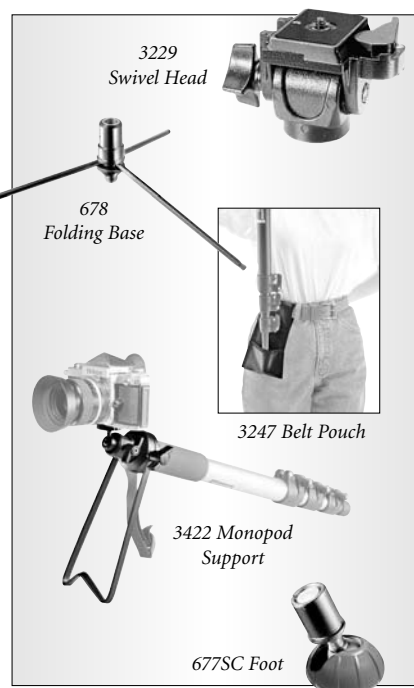

### MANFROTTO MONOPODS

|          | Sections | Minimum Height | Maximum Height | Weight   | Load Capacity |
|----------|----------|----------------|----------------|----------|---------------|
| 676B     | 4        | 18.9"          | 60.6"          | 14.1 oz. | 10 lbs.       |
| 679/679B | 3        | 25.2"          | 63.8"          | 1.3 lbs. | 22 lbs.       |
| 680/680B | 4        | 20"            | 60.6"          | 1.8 lbs. | 22 lbs.       |
| 681/681B | 3        | 26.4"          | 63.4"          | 1.7 lbs. | 26.4 lbs.     |
| 682/682B | 3        | 29.1"          | 67.7"          | 2.4 lbs. | 26.4 lbs.     |
| 684B     | 3        | 27.9"          | 65.6"          | 1.6 lbs. | 17.6 lbs.     |
| 694      | 4        | 20.9"          | 65"            | 1.3 lbs. | 11 lbs.       |
| 695      | 5        | 18.1"          | 63"            | 1.3 lbs. | 11 lbs.       |
| 3245     | 3        | 26.7"          | 65.4"          | 1 lbs.   | 17.6 lbs.     |

**ORDER & INFO. (212) 502-6340 • FAX: (212) 239-7770 (800) 947-7008  
1-800-290-6750 • www.bhphotovideo.com**



# MANFROTTO

## BALL HEADS

TRIPODS

476

Manfrotto's comprehensive range of ball heads offer smooth movement and positioning of the camera, 360° panning movement plus 90° tilt, positive locking and quick release camera plate on some heads. Ball heads are favored over 3D heads when speed and compact size is important.

### 482 Micro Ball Head

Designed for use with small, compact cameras. The aluminum housing and extremely hard resin ball provides smooth movement. A single control lever locks the ball and pan movements. Ideal for the 3007 table top tripod, car window clamp 3293 or 3287 monopods and Super Clamp 2915 combined with 2907 adapter. Supplied with a large 50mm camera platform. 4.4 lb. maximum load.

BO482.....31.95

### 484 Mini Ball Head

Designed with the SLR photographer in mind, the 484 Mini Ball Head features a strong die-cast construction, precision machined aluminum housing, and an extremely hard phenolic resin ball which provides smoother movements across all tilt positions. The double-groove also makes this head extremely versatile, and the single ratchet control lever securely locks both the ±90° ball and 360° pan movements. Camera attachment is via a 2" platform with a 1/4-20" male thread, and head to tripod attachment is 3/8" female. Maximum load is 8.8 lb.

BO484.....37.95

### 484RC2 Mini Ball Head

Same as the 484, except this versatile head is fitted with a 3157N quick-release camera plate with a secondary safety catch. This head is perfect for 35mm SLR cameras with medium lenses, and light medium format cameras. Incorporates a spring-loaded, retractable dual thread (both 1/4-20" and 3/8") for your camera and tripod mount, and features single lever operation. It accepts a maximum load of 8.8 lbs.

BO484.....51.95

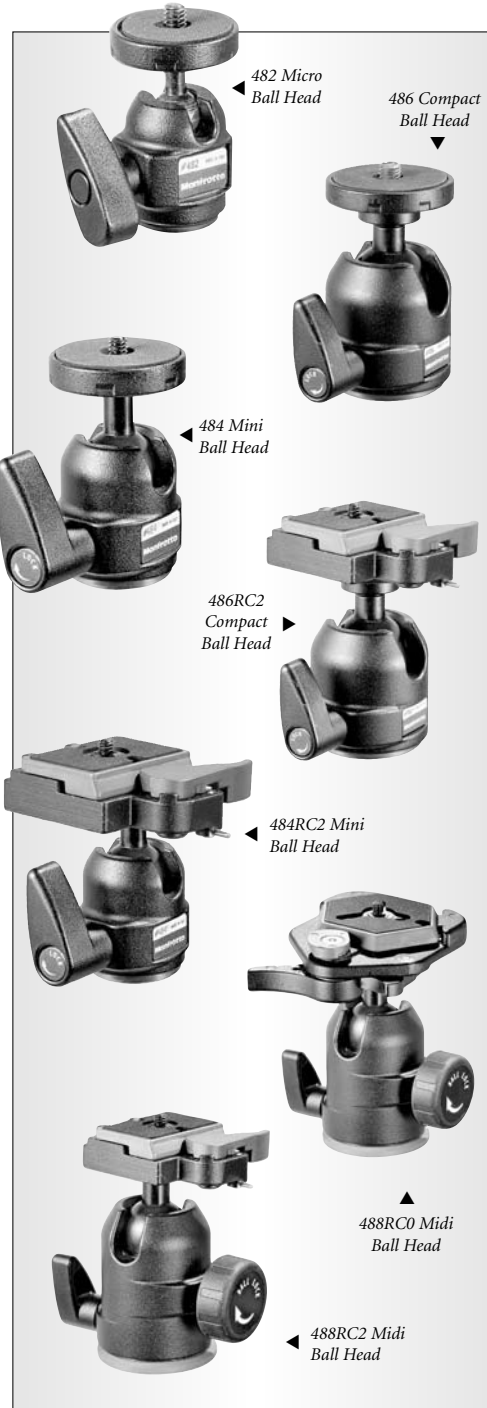

### 486 Compact Ball Head

Compact, yet strong enough to support heavier camera loads. Strong die-cast construction, precision machined aluminum housing, and an extremely hard phenolic resin ball provides smooth movements across all tilt positions. Has a single ratchet locking knob for 360° pan and a double groove for ±90° tilt movements. Camera attachment is via a 2" platform with a 1/4-20" thread. 13.2 lb. maximum load.

BO486.....53.95

### 486RC2 Compact Ball Head

Same as the 486 but equipped with a 3157N quick-release camera plate.

BO486RC2.....61.95

### 488 Midi Ball Head

With solid aluminum construction and phenolic resin ball, the 488 head has a maximum load of 17.6 lbs. Has a double-groove for rapid side-to-side movement, and a separate fast-action ratchet lever for 360° pan and easy grip locking knob for ±90° tilt movements. 2" camera platform with a 1/4-20" male thread.

BO488.....78.90

### 488RC0 Midi Ball Head

Same as the 488 but equipped with a 3049 quick-release camera plate with a secondary safety catch and two spirit levels for precise levelling on both vertical or horizontal axis. It features a separate fast action ratchet lever for 360° pan and an easy to grip locking knob for ±90° tilt movements.

BO488RC0.....95.95

### 488RC2 Midi Ball Head

Same as the 488 but with a 3157N quick-release camera plate with a secondary safety catch. Features a separate fast action ratchet lever for 360° pan and an easy to grip locking knob for ±90° tilt movements.

BO488RC2.....95.95

### 488RC4 Midi Ball Head

Same as the 488 but with a 3271 quick-release camera plate with a secondary safety catch and two spirit levels for precise levelling on both vertical or horizontal axis.

BO488RC4.....95.00



# MANFROTTO

## BALL HEADS

### 490 Maxi Ball Head

The top of Manfrotto's ball head line, the 490 is made in die-cast aluminum with a precision phenol resin ball. Separate locks on 360° pan and ±90° tilt movements, with an additional friction control on the ball movement, gives just the right resistance and smoothness with minimum effort, even when varying weights of equipment. The 490 attaches to the camera via a 2" platform with a combined 1/4-20" and 3/8" male thread. Maximum load is 26.4 lbs.

BO490.....162.95

### 490RC4 Maxi Ball Head

Same as the 490 but equipped with a 3271 quick-release camera plate with a secondary safety catch and two spirit levels for precise levelling on both vertical or horizontal axis.

BO490RC4 .....178.95

### 3265 Grip Action Ball Head

Versatile, quick and easy to use. Just grip the handle and you can position your camera anywhere within a 180° sphere. Supplied with a quick release assembly, camera plate with secondary safety catch, built-in bubble level and tension adjustment. Made of cast aluminum, this head is ideal for cameras with short or medium focal length lenses. 1/4-20" camera attachment. 5.5 lb. maximum load.

BO3265 .....86.95

### 322RC2 Horizontal Grip Action Ball Head

Take the versatility of a ball head, add true ergonomic control and you get the 322RC2. The revolutionary design of the 322RC2 allows you to unblock, move, position and lock your camera with one hand in one position. A friction control wheel lets you regulate the power of the blocking mechanism to match the weight of your camera and lens. The 322RC2 is made from magnesium for lightweight performance, and is designed to keep the weight of your equipment as close as possible to the tripod's center of gravity by way of its reduced height. Includes a built-in bubble spirit level and quick release camera plate (1/4 - 20" screw, with secondary safety pin). Load capacity is 11 lbs (5.5 lbs in the vertical position).

In addition, mount the 322RS remote control electronic camera shutter release, and the 322RC2 puts camera control within reach without having to move your hand from the head grip to the camera body.

BO322RC2 .....104.95



### 468MG Series Hydrostatic Ball Heads

The 468MG Hydrostatic Ball Head range features an unmatched advanced friction and locking mechanism. Just a slight turn of the locking knob applies enough pressure to firmly hold the camera. When it's time to move the camera, it's just as easy to unlock, and with adjustable friction set, your camera will never get away from you.

These heads incorporate an advanced ball locking mechanism using hydrostatic action. Based on principles of modern hydraulics where force that is applied at one point is transmitted to another point using an incompressible fluid, the locking process is improved using a special liquid inserted in the internal chamber. When pressure is applied, the liquid blocks the movement of the ball. Because the force exerted by the liquid is more constant and evenly distributed, locking power is dramatically improved.

The camera and head move in unison with no headway effect during the locking phase. The heads also have a calibrated, adjustable tension control allowing the ball tension to be preset for various camera weights.

In addition, they each feature an independent pan and tilt lock with 360° pan movement and ±90° tilt movement. The body of each head is constructed in magnesium die casting with a 2" Teflon coated aluminum ball, enabling smoother camera movements.

**468MG:** Weighs 1.4 lbs and has a maximum load of 35.3 lbs. (BO468MG) .....269.95

**468MGR0:** With RCO Rapid Connect System, weighs 1.9 lbs and has a maximum load of 35.3 lbs. (BO468MGR0).....299.95

**468MGR2:** With RC2 Rapid Connect System, weighs 1.4 lbs and has a maximum load of 22 lbs. (BO468MGR2).....279.95

**468MGR3:** With RC3 Rapid Connect System, weighs 1.8 lbs and has a maximum load of 35.3 lbs. (BO468MGR3).....311.95

**468MGR4:** With RC4 Rapid Connect System, weighs 1.6 lbs and has a maximum load of 35.3 lbs. (BO468MGR4).....307.95

**468MGR5:** With RC5 Rapid Connect System, weighs 1.6 lbs and has a maximum load of 26.5 lbs. (BO468MGR5).....309.95

TRIPODS

477

# MANFROTTO

## 3-WAY HEADS

TRIPODS

478

A tripod head is just as important as a tripod. It is necessary to match the task of the tripod, head and camera. For this reason, Manfrotto offers a wide range of heads designed to carry loads from ultra-lightweight up to 26 lbs. Manfrotto's 3-Way Heads are precision-engineered to provide smooth and independent control of pan, backward and forward tilt, plus side-to-side tilt movements. In fact, the camera position can rapidly change from landscape (horizontal) to portrait (vertical) or adjust to the appropriate angle that best suits the shot. Large rubber grips on the pan and tilt handles provide efficient control. All heads come supplied with standard 1/4-20" threaded camera screw.

### 3437 3D Magnesium Head (BO3437)

Cast from lightweight magnesium, this innovative 3D head can be positioned in virtual any position to get the exact framing of the image. Lock-system using spring-loaded conical joint allows greater flexibility than any other 3D head whether mounted on a tripod center column or lateral arm. The rubber grip knobs provide fingertip control and won't poke you in the eye like conventional handles do. Supports up to 6.6 lbs .....**79.95**

### 3025 3D Junior Head (BO3025)

A self-adjusting conical bearing locking system allows 360° rotation on both the vertical and horizontal plane. This is the ideal head for SLR and lens up to 6.6 lbs .....**26.95**

### 3030 Pan Tilt Head with QR Plate (BO3030)

Full 3-way action with each axis movement controlled by a separate locking handle. Incorporates a quick-release plate with safety lock to make camera changes as easy as flipping a lever. Handles up to 13.2 lbs .....**60.95**

### 3029 Pan Tilt Head (BO3029)

Same as 3030 without the quick release assembly, camera plate and secondary safety catch .....**49.95**

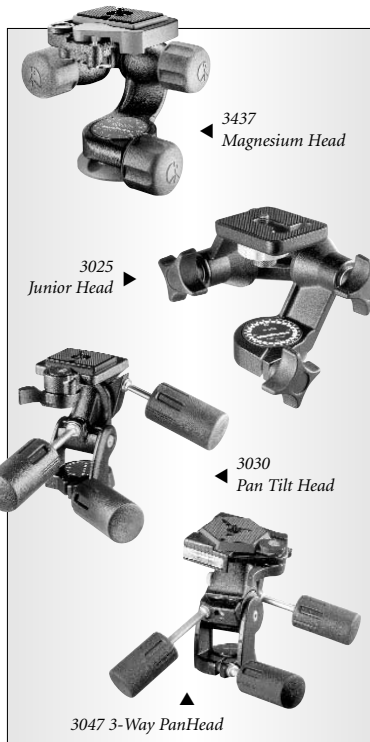

### 3047 Deluxe 3-Way Pan Head (BO3047)

This 3-way pan head handles up to 16.5 lbs. and features a quick-release assembly camera plate with secondary safety catch, two bubble levels and three large, easy grip rubber handles for precise positioning .....**82.95**

### 329RC4 Low Profile Head with Quick Release (BO329RC4)

This professional 5.1" head is suitable for a wide range of cameras up to large format. The key is its low profile which ensures that the camera's center of gravity is over the center of the tripod for maximum stability and control. Also offers a wedge-shaped quick release plate system, friction adjustment on the three movement controls, and a spirit level for tilt and levelling plus a spirit level in the base for panoramic shots. Maximum load capacity is 20 lbs .....**104.00**

### 3039 Super Pro Head with Quick Release (BO3039)

Finely machined for greater positioning with smooth, certain action. 3 built-in spirit levels for horizontal and vertical control. A quick release camera plate with a secondary safety catch offers added security. Handles up to 26 lbs .....**174.95**

## GEARED HEADS



### 3263 Deluxe Geared Head (BO3263)

This unique head offers precise geared movement in three directions. Separate fold away rotating handles for pan and tilt and side-to-side leveling. In addition, the tension holding the round quick release plate can be released to allow fine adjustment with complete safety. Designed to mount on larger tripods, this geared head is for medium format cameras providing the ultimate in fine adjustment and control to achieve the exact framing required. Includes three 1/4-20" screws for camera attachment .....**592.95**

### 3275 410 Compact Geared Head (BO3275)

Extremely compact, this unique head offers gear movement in three directions, pan, tilt and side-to-side tilt. It incorporates a quick release camera plate system and is suitable for SLR cameras. Maximum load capacity is 11 lbs .....**183.95**



### 405 Pro Digital Geared Head (BO405)



The 405 Pro Digital Geared Head is designed for digital photographers who shoot with camera/back payloads up to 16.5 lbs.

The 405 utilizes large, easy-to-grip knobs that provide smooth, positive, geared control through 360° pan and +90° - 30° frontal and lateral tilt. In addition to its 3-D geared functions, the 405 also allows you to instantly disengage the gears and rough position the camera by hand, then instantly reengage them for ultra-precise final alignment. The 405 comes complete with quick-release plate, 1/4" and 3/8" camera mounting screws, and 3/8" tripod mount .....**305.95**



www.bhphotovideo.com

# MANFROTTO

## QTVR SYSTEMS

### 300N Panoramic Head

This head lets you set 10 different angles of rotation: (5, 10, 15, 18, 20, 24, 30, 36, 45, 60, 90°) or the number of shots (37, 36, 24, 20, 18, 15, 12, 10, 8, 6, 4 shots) spanning 360° rotation using the engraved, graduated scale markings for reference. The head can be used for precise sequential and constant angle shots or simply for panning and reading the angle of motion. The camera can mount directly to the head with the optional 3054 1/4" adapter or on any Ball or 3D head which mounts on the Panoramic Head.



BO300N .....162.95

### 303 QTVR Panoramic Head Kit (BO303)

Designed for QuickTime virtual reality technology which allows virtual scenes to be created by computer from panoramic digital or digitized images obtained from single shots stitched together. Suitable for most SLR and digital still cameras using wide-angle lenses. The kit includes a leveling base enabling fine, fingertip adjustment of  $\pm 5^\circ$  to ensure the camera is perfectly level, the 303 Panoramic Head, and an elbow bracket to ensure the optical center of the lens is above the point of rotation to avoid parallax errors and ensure perfect QTVR sequence. The kit features double sliding plate with 3.1" of adjustment for precise positioning, spirit level and graduated scale to set the angle of rotation from 10° to 90° or the number of shots spanning 360° .....324.95

### 303 Plus (BO303P)

Similar to the 303 but it incorporates precise geared movement of the 2 sliding plates used to position the camera on the panoramic axis of rotation. A release button disengages the gear to facilitate rapid movement of the plates when required.....379.95



## 303SPH QTVR SPHERICAL PANORAMIC HEAD KIT

The 303SPH is a multi-row (spherical) panoramic photography head. It has sliding plates to position the camera over the panoramic axis of rotation, plus a sliding plate which rotates around the front/back tilt axis. This allows the camera to be rotated on both horizontal and vertical axis around the camera/lens nodal point, so multi-row panoramic photo sequences (cubic VR photos) can be taken accurately and easily.

Using the 303SPH ensures that software used for photo stitching produces a precisely composed VR environment with minimum post-production intervention or software correction. The 303SPH's vertical bracket can be unlocked and rotated through 90° (then re-locked) so that the head takes up less space in transport, and so that the sliding plate mechanisms are protected against knocks and bumps. The 303SPH comes complete with an extra set of sliding plates for use with cameras of different sizes.



- ◆ Three sliding plates for precise nodal point positioning on all planes/axes.
- ◆ Short plates included for more convenient use with compact cameras.
- ◆ Long plates included for use with larger SLR or medium format cameras.
- ◆ Camera attachment via 1/4 - 20" and 3/8" male screw.
- ◆ 3/8" female tripod fitting.
- ◆ Dual graduated scale to set the angle of rotation to any of the following: 90°, 60°, 45°, 36°, 30°, 24°, 20°, 15°, 10°, 5° (respectively equivalent to 4, 6, 8, 10, 12, 15, 18, 24, 36, 72 photos to achieve a full 360° rotation) - on upper part of 300N rotation unit.
- ◆ Graduated scale from 0° to 360° on lower part of 300N rotation unit.
- ◆ By removing vertical brackets, the 303SPH can also be used as an object turntable.
- ◆ Vertical bracket folds down and removes for compact size during transport.

TRIPODS

479



# MANFROTTO

## TRIPOD ACCESSORIES

TRIPODS

480

### 3288 Elbow Bracket (BO3288)

The "Elbow Bracket" enables one to rapidly change from a horizontal to a vertical shooting position, without having to reposition the tripod and to keep an axis of vision which is vertical to the tripod itself, thus avoiding the threat of tilting.

Compatible with the following heads: 3047, 3039 and 488RC0. Comes complete with 1/4"-20" to 3/8" screws .....57.50

### 341 Junior Elbow Bracket (BO341)

Enables you to rapidly change from a horizontal to a vertical shooting axis, without having to reposition the tripod. Its adjustable stop prevents accidental camera rotation. Great for small & medium sized cameras with telephoto lenses. Use on all heads equipped with the 3157N type of camera plate, including: 3030, 3265, 3437, 468RC2, 486RC2, 488RC2, 468RC2.....58.95

### 155RC Double Ball Joint Head with Quick Release Adapter (BO155RC)

Not strictly a tripod head, but an extremely versatile support for compact and 35mm cameras used in conjunction with the 2915 Super Clamp. Supplied with quick release plate and secondary safety lock .....47.95

### 2929QR Variable Friction Magic Arm with Quick Release Plate (BO2929QR)

Articulated arm with large locking knob, variable friction and locking of arm is done by adjusting the knob. Supplied with quick release camera plate with secondary safety lock. Ideal for mounting a camera exactly at the angle you need it. Fits any 5/8" female socket, works especially well with 2915 Super Clamp. ....105.95

### 2930QR Magic Arm with Quick Release Plate (BO2930QR)

Your extra arm in the studio. One lever locks three pivot points. Supplied with a quick release camera plate with a secondary lock. Ideal for mounting a camera exactly the angle you need it. Fits any 5/8" female socket, works great with 2915 Super Clamp. ....109.95

### 3502 Ball Camera Leveller (BO3502)

Weighing 1.4 lbs. and capable of holding 33 lbs., the 3502 provides fast leveling for tripods without built-in levels. Fits between the center column and head and has 10° of adjustment .....69.95



### 3419 Micro Positioning Plate (BO3419)

Ideal for macro photography to make precise positioning movements, for QTVR and other precise copy/repro work, the sliding plate has finger tip control for ultra-fine positioning – but with a simple lock-release lever for fast set-up. Two plates can be interlocked at 90° for full lateral/ forward/back movement (over 4.7"). In extruded aluminum, the plate has 1/4"-20" and 3/8" holes and screws for tripod and camera mounting .....86.95

### 3500 Pump Cup with Flat Base (BO3500)

A suction cup for lightweight equipment. The disc's diameter is 2.3", it weighs 1.36 lbs. and has a 3/8" thread to accommodate most any Manfrotto head .....61.95

### 3289 Suction Grip with Camera Support (BO3289)

Attaches to most non-porous surfaces. Ideal camera support in automobile or next to a window. Incorporates a separate brace that is designed to go down to the car floor for added stability.....96.95

### 3292 Car Window Pod (BO3292)

Clamps onto car window, with a 3/8" thread to accept small or medium sized Manfrotto heads.....25.95

### 3292 Car Window Pod with 3-Way Pan/Tilt Head with Quick Release (BO3292390RC2)

This kit combines the 3292 Pod with the 390RC2 3-way pan/tilt head.....72.90

### 3294 Suction Grip with Socket (BO3294)

Suction cup for small fixtures and lightweight equipment .....56.95

### 2915 Super Clamp (BO2915)

This universal clamp can be securely mounted on any tube from 0.5 to 2.1". Attachment is 5/8" hexagonal socket. It includes a wedge adapter to allow clamping onto a flat surface .....24.95

### 2934 3/8" Head Mounting Plate (BO2934)

Allows use of 3/8" camera mounting plate into 16mm socket. Compatible with 2915 Super Clamp and 484RC2 or 486RC2 Ball Head for example .....19.95

### 208Hex Head Mounting Plate (BO208HEX)

Same as 2934 Head Mounting Plate with a 3/8" thread Hex stud .....19.95



EQUIPMENT LEASING AVAILABLE

# MANFROTTO

## TRIPOD ACCESSORIES

TRIPODS

481

### 3287 Photo Clamp (BO3287)

Used to attach your camera to hard-to-get-to places. Can be fixed to surfaces up to 2.3" thick. Has 2x 3/8" male threads for mounting ball head and camera .....**27.95**

### 3430 Leg Protectors (BO3430)

Set of three leg protectors (14" long) with a zip system so they can be easily fitted and won't slip down when in use. Offers good grip. Protect the legs and insulate your hands when using the tripods in cold weather. For 3011N, 3021N and 3021PRO .....**31.95**

### 3431 Leg Protectors (BO3431)

Same as above except 10" long. Fits the 3001N, 3001D and 3001PRO tripods.....**34.50**

### 233B Camera Bracket (BO233B)

Camera flash bracket with telescopic column from 11.8" to 17.7" .....**46.95**

### 3276 Table Mount Camera Support (BO3276)

A simple table mounting support with three holes for fixing or clamping.....**42.95**

### 3278B Macro Flash Bracket (BO3278B)

Allows two shoe mount flash heads to be mounted with a camera onto a tripod head. Attachments: 3/8" and 1/4-20" female threads and 1/4-20" camera screw. Allows horizontal or vertical camera position .....**49.95**

### 337 Hot Shoe Two-Axis Bubble Level (BO337)

A double axis spirit level that mounts effortlessly to the hot shoe of any standard 35mm SLR camera to help you achieve a finer degree of accuracy in capturing image content. Ideal during QTVR shooting sessions .....**34.95**

### 3420 Telephoto Lens Support (BO3420)

Support for medium telephoto lens. The length of the bracket is adjustable to take different length lenses and different diameters by tilting the included 3229 Tilt Head. Length of the lens support is adjustable from 7.8 to 11.6". Attachments: 4 x 3/8" female and 3 x 1/4-20" female .....**61.95**

### 3252 Super Telephoto Support (BO3252)

A very useful addition to any photographers accessory bag. Complete with Super Clamp 2915 and Mini Ball Head 482. Fully adjustable between 15.7" and 23.6" with a simple telescopic locking device .....**49.95**



### 3424 Column Clamp (BO3424)

Versatile clamp designed to work in conjunction with removable tripod columns of between .98" to 1.1" diameter, such as the 3001 and 3021 Series tripods. It can be securely fixed to solid surfaces or bars up to 2.1" width. The column with head is inserted into the clamp and locked in position at the required height. The ideal accessory for nature photography or support for binoculars and scopes .....**64.50**

### 3253 Table Mount Geared Column with Clamp (BO3253)

Geared column with clamp for table thickness from 8-1.5", for supporting a camera adjustable between 2" and 26". Head not included .....**129.95**

### 3059 Accessory Side Arm (BO3059)

Mounts on any column with 3/8" thread, this side arm allows positioning of two heads at a 90° perpendicular to the tripod column. 23" long. Chrome color .....**49.95**

### 3059B Accessory Side Arm (BO3059B)

Same as above in black color .....**49.95**

### 3153 Double Head Support (BO3153)

Similar to the 3059 with the addition of two adjustable head mounts on the side arm allowing the possible mounting of four heads. 23" long. chrome .....**76.95**

### 3153B Double Head Support (BO3153B)

Same as above in black color .....**79.95**

### 3269 Double Camera Support Platform (BO3269)

Measures 11 x 2 3/4". Designed to fit any tripod head. Has 3/8" female socket. Allows you to mount two cameras on a single head. Supplied with two 1/4" and two 3/8" camera fixing screws .....**52.95**

### Apron Support (BO3146)

Attaches to tripod legs and allows for storage space beneath the center column. It can also be used to hold a sandbag or stones for extra support. Fits most Manfrotto tripods .....**27.95**

### 3295 Anti-Theft Plate (BO3295)

For heads with hexagonal plates. Key lock system for camera release. 78" steel cable .....**58.95**

ORDER & INFO. (212) 502-6340 • FAX: (212) 239-7770 (800) 947-7008  
**1-800-290-6750 • www.bhphotovideo.com**



# MANFROTTO

## TRIPOD ACCESSORIES

TRIPODS

482

### Tripod Feet

#### Rubber/Metal Spiked Feet

Reversible rubber/metal spiked feet supplied with a dedicated fixing tool. The spike is made of a special hard stainless steel alloy extremely resistant to corrosion.

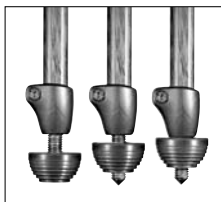

- Retractable Spiked Feet (BO055SPK2):** Set of 3, for 3011N, 3021N and 3021PRO .....**26.95**
- Retractable Spiked Feet (BO190SPK2):** Set of 3, for 3001N, 3001D and 3001PRO .....**29.95**
- Retractable Spiked Feet (BO440SPK2):** Set of 3 for 3444 .....**33.95**
- Retractable Spiked Feet (BO441SPK2):** Set of 3 for 3443 .....**34.95**

#### Suction Cup/Retractable Spike Feet

A rubber suction cup feet with retractable stainless steel spike. The suction cup increases the footprint of the tripod by almost 20 times, giving much greater stability when needed. The feet can be removed and replaced at will.

- Suction Cup Set (BO055SCK2):** Set of 3, for 3011N, 3021N and 3021PRO .....**49.95**
- Suction Cup Set (BO190SCK2):** Set of 3, for 3001N, 3001D and 3001PRO .....**49.50**
- Suction Cup Set (BO440SCK2):**  
Set of 3 for 3444 .....**49.50**
- Suction Cup Set (BO441SCK2):**  
Set of 3 for 3443 .....**49.50**

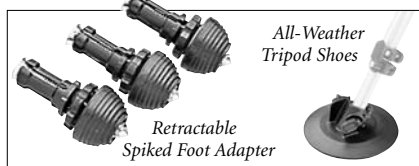

- Retractable Spiked Foot Adapter (BO055SPK):** Reversible rubber/metal spike feet (set of 3) as accessory for tripods 3011N, 3021N, 3021PRO, 3001N, 3001D and 3001PRO **26.95**

- All-Weather Tripod Shoes (BO230):** Attach to tripod feet or monopods to provide stability in snow, mud or soft ground. For tripods 3011N, 3021N, 3021PRO, 3001N, 3001D and 3001PRO .....**19.95**

### Levelling Center Columns

This innovative system means you can quickly level your photo or video head without needing to make time-consuming adjustments to the length and angle of each single tripod leg. One of the most common problems in still photography and, above all, video has been resolved by Manfrotto, thanks to the use of a 50mm diameter leveling half ball mounted at the top of a tripod center column so as to make the angle of the top plate independent of the rest of the tripod. Locking and unlocking of the half ball is via a turning grip on the bottom of the center column. The half ball-mounting plate has a male 3/8" screw for attachment to a photo or video head, and a bubble spirit level for added ease of use.



- 554 Leveling Center Column (BO554):** Carbon fiber version for 3444 and 3443 tripods .....**182.95**
- 555B Leveling Center Column (BO554):** Aluminum version for 3021PRO tripod .....**108.95**
- 556B Leveling Center Column (BO554):** Aluminum version for 3001PRO tripod .....**96.95**

### Short Columns

To improve the positioning flexibility of your tripods, shorter center columns are available as an accessory. If you need to work with legs set at the third or fourth angle of inclination (about 60°) but still require the possibility to move the camera up and down to achieve perfect adjustment for the shot, this shorter column replaces the one supplied with the tripod.



- 6.9" Short Column (BO055CCSB):**  
For 3011N, 3021N, 3021PRO tripods .....**29.95**
- 6.5" Short Column (BO190CCSB):**  
For 3001N, 3001D, 3001PRO tripods .....**29.95**
- 6.5" Short Column (BO445CCS):** For Carbon Fiber series tripods .....**49.50**

- 3007KIT Tabletop Tripod Kit (BO3007K)**  
Small and portable, this kit fits into any camera bag ready to give quick support to a lightweight camera. The kit includes a 482 Mini Ball Head, a 3007 TableTop Tripod, an extension and a tripod pouch. The pouch easily attaches to your belt and has a Velcro fold over flap to secure the kits safely. ....**62.80**



- 3504 Tool Kit (BO3504)**  
A set of tools to adjust the locking collars of most Bogen/Manfrotto tripods, stands and monopods. The kit includes a screwdriver and a hexagonal tubular socket .....**16.95**



# MANFROTTO

## TRIPOD ACCESSORIES

### Plates

**Rapid Connect Hexagonal Plate (BO3041)**  
With 1/4-20" flush mount .....**19.50**

**Rapid Connect Hexagonal Plate (BO3042)**  
Same as above except with 3/8" screw .....**19.50**

**Rapid Connect Hexagonal Plate (BO3049)**  
For quick-release system. Supplied with 1/4" camera screw .....**17.95**

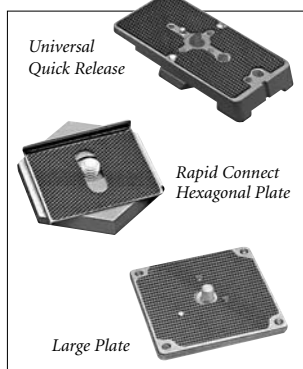

**Rapid Connect Hexagonal Plate (BO3048)**  
Same as above except with 3/8" screw .....**19.50**

**Rapid Connect Hexagonal Plate (BO3267)**  
This plate provides proper alignment for 90° vertical architectural shots with 35mm cameras. Supplied with 1/4"-20 camera screw .....**23.95**

**Rapid Connect Hexagonal Plate (BO3267A)**  
Same as above except with 3/8" screw .....**19.50**

**Rapid Connect Rectangular Plate**  
For quick-release system. Available with 1/4"-20 camera screw (BO3157N) or 3/8" screw (3157AN) .....**11.95**

**Rapid Connect Architectural Rectangular Plate (BO3157NR)**  
Provides proper camera alignment for 90° vertical architectural shots with 35mm cameras. Supplied with 1/4"-20 camera screw .....**22.95**

**Rapid Connect Architectural Rectangular Plate (3157ANR)**  
Same as above except with 3/8" screw .....**22.50**

**Large Plate (BO3297)**  
Large 4x4" platform accept hexagonal quick-release plates. Supplied with 1/4-20" and 3/8" screw .....**29.95**

**Universal Quick Release Rectangular Plate for Hexagonal Quick Release Heads (BO3030U)**  
Supplied with both 1/4-20" and 3/8" screw .....**27.50**

**Dove Tail Accessory Plate (BO384PL14)**  
Supplied with 1/4-20" screw .....**17.95**

**Dove Tail Architectural Plate (BO384PLA14)**  
Provides alignment for 90° shots with SLR cameras. Supplied with 1/4"-20 screw .....**19.95**

**Rapid Connect Mounting Plate (BO3271)**  
With 1/4-20" and 3/8" fixing screws .....**11.95**

**Rapid Connect Adapter Assembly with Sliding Mounting Plate (BO577)**  
Supplied with 1/4-20" and 3/8" camera screws. Includes 3433PL slide plate .....**49.95**

### Quick Release Adapters

**Rapid Connect Adapter (BO625)**: Hexagonal plate adapter supplied with 1/4-20" and 3/8" camera fixing screws. Fixing 1/4-20" and 3/8" thread. Includes 3049 hexagonal plate. Equipped with two built-in spirit levels .....**49.95**

**Compact Rapid Connect Adapter (BO3299)**: Rectangular plate adapter supplied with 1/4-20" and 3/8" camera fixing screws. Fixing 1/4-20" and 3/8" thread. Includes 3157M rectangular plate .....**26.95**

**Dove Tail Rapid Connect Adapter (BO384)**: Supplied with 1/4-20" and 3/8" camera fixing screws. Fixing 1/4-20" and 3/8" thread. Includes both the Dove Tail Accessory Plate and Architectural plates .....**54.95**

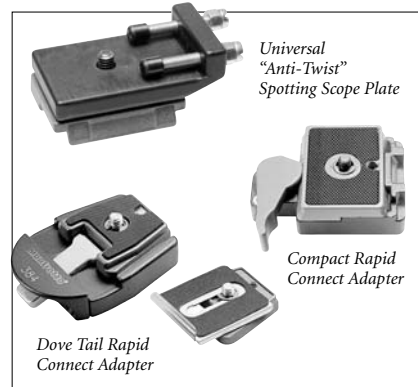

**Low Profile Rectangular Rapid Connect Adapter (BO394)**: Plate adapter supplied with 1/4-20" and 3/8" camera fixing screws. Fixing 1/4-20" and 3/8" thread. Includes 3271 plate. Equipped with two built-in spirit levels .....**39.95**

**Universal Sliding Plate (BO3273)**: Supplied with 1/4-20" and 3/8" camera fixing screws. Fixing 1/4-20" and 3/8" thread. Includes 3272 sliding plate .....**39.95**

**Universal "Anti-Twist" Spotting Scope Plate (BO200USS)**: Eliminates unwanted rotation of the spotting scope during viewing. It has a standard 1/4" screw, and two grub set screws to lock the spotting scope securely in position .....**59.95**

### Adapters



**2907 Camera Mounting Stud (BO2907)**: Reversible stud with 3/8" and 1/4". To mount cameras flush on the 2915 Super Clamp .....**3.95**

**3367 Small Adapter (BO3367)**: Female 1/4-20" to male 3/8" adapter with flange .....**7.95**

**3298 Nikon Flash Adapter (BO3367)**: Converts Nikon flash mount to universal flash bracket .....**7.95**

**3428 Survey Adapter (BO3428)**: Converts tripod head screw from 3/8" threads to 5/8" .....**37.50**

**3049LS Metz Flash Screw (BO3049LS)**: A special long 1/4-20" camera screw used in conjunction with the hexagonal 3049 camera plate which allows you to fit the Metz flash bracket .....**8.95**

**3054 Converter Plate (BO3054)**: Converts tripod head screw from 3/8" to 1/4-20". Allows any Manfrotto tripod to accept heads with 1/4-20" socket .....**17.50**

**3154 Joint for Arms (BO3154)**: Double female 3/8" adapter allows using accessory arms 3059 and 3153 as column extensions .....**19.50**

**2932 Flash Shoe (BO2932)**: Flash shoe with 1/4-20" male thread attachment .....**6.95**

TRIPODS

483

# MANFROTTO

## TRIPOD BAGS & CARRYING SYSTEMS

TRIPODS

484

*A tripod is a wonderful thing. Carrying one has never been — until now.*

*Manfrotto has developed a complete range of carrying and transportation solutions designed around the tripod.*

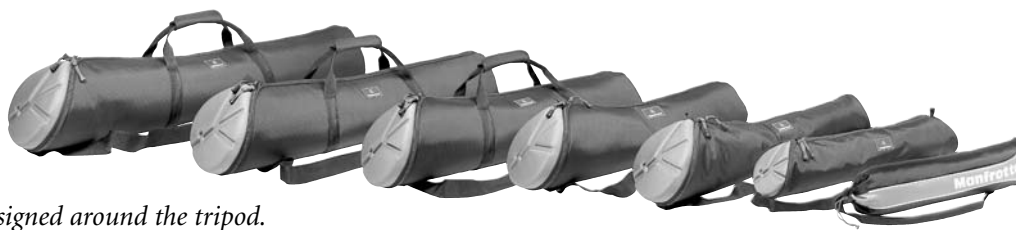

*These contoured bags are worked from the inside out to fit your kit. They offer convenient ways of setting up and breaking down faster, a “space pad” that lets you shoulder carry your tripod without risking bangs and bruises, and an open backpack that keeps your hands free. Whether you want a handle or strap that doesn’t have to be removed from your tripod when you set up a shoot, or whether you need a protective shell to keep your tripod safe, Manfrotto has the solution. With innovative technical features, prime materials and first class construction methods, the quality of their bags and carrying solutions are up to the high standards you expect from Manfrotto.*

### PADDED TRIPOD BAGS



#### 47.2" Padded Tripod Bag (BOMBAG120P)

A ballistic nylon asymmetric tapered tripod bag that allows you to store the tripod with the head attached.

The tripod legs fit comfortably in the

narrower end (7.87" diameter) and extra space is allowed for the head at the wider end (9" diameter). A zip extends down the length of the bag, but also fully opens the top end of the bag, making it easier to get to your tripod. Thermoform padding holds the tripod in place and protects it, especially the head, during transport. Inner pocket holds accessories where they won't rattle around or get damaged. This bag can be hand-carried horizontally by the side handle, vertically by the end handle, or shoulder-carried using the included strap.....**124.95**

#### 39.3" Padded Tripod Bag (BOMBAG100P)

Same as MBAG120P, but slightly smaller ....**99.95**

#### 35.4" Padded Tripod Bag (BOMBAG90P)

Same as MBAG120P, but smaller .....**94.95**

#### 31.5" Padded Tripod Bag (BOMBAG80P)

Basically the same as MBAG120P, but smaller, without the side handle or inner accessory pocket. It is also narrower than the other padded bags. The narrow end measures 5.1" diameter, the wide end measures 5.9" .....**69.95**



End handle

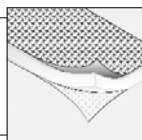

Padded bag

*All padded bags feature 1680 Denier water proof super nylon, and an end handle. And with the exception of the 31.5" Padded Bag, they also feature a central handle and an internal pocket that holds a video head pan bar.*

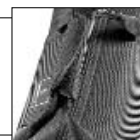

Central pocket



Internal pocket

### UNPADDED TRIPOD BAGS

#### 31.5" Unpadded Tripod Bag (BOMBAG80)



This unpadded tripod bag is slightly tapered to provide a better fit for your tripod with an attached head. The wider end of the bag

accommodates the head without requiring all levers to be removed. It also features a zip-

per that extends down the length of the bag, but also fully opens the top end of the bag. A logo end cap is padded to offer protection to the tripod head. This bag includes a shoulder strap.....**49.95**

#### 27.5" Unpadded Tripod Bag (BOMBAG70)

Same as MBAG80, but slightly smaller at 27.5" in length .....**39.95**

#### Mini Air Bag (BOMBAGD)

An unpadded rucksack-style bag for small tripods. It has a bungee cord top opening and adjustable straps, and comes in resistant nylon with printed Manfrotto logo.....**17.95**



# MANFROTTO

## TRIPOD BAGS & CARRYING SYSTEMS

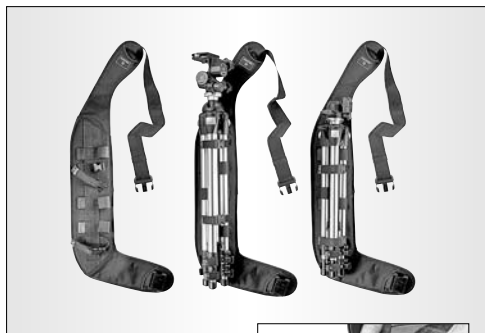

Straps can be removed and custom-positioned to better match the size of your tripod.



### Quick Action Strap (BO401N)

A quick and easy accessory for carrying your tripod when walking, hiking, cycling or just getting from shoot to shoot. Use the shorter straps to fasten the padded Quick Action Strap to one of the legs of your tripod, bind the remaining legs together using the longer adjustable quick release straps, sliding the tripod over your shoulder and you're ready to go, with your hands free to grab those vital last minute items. The padding helps hold the tripod in place and protects your back from bruises and chaffing. The Quick Action Strap even stays attached to your tripod when shooting (all you need to do is release the longer quick release straps so you can maneuver and position all three legs), so you're always ready to capture the images you want, but also always ready to move off again to the next location .....52.95



### LONG STRAPS

#### Long Grey Strap (BO3044)

A basic 2" wide strap to carry your kit. A spring clip fastens quickly to the steel ring at the shoulder of the tripod, and a closed loop goes around the feet of the tripod, to grip them securely. It features an adapter for compatibility with all Manfrotto tripods and comfortable rubberized fabric to avoid the tripod slipping on your shoulder .....26.95



#### Long Green Strap (BO102NAT)

Same as the above, but in green rubberized fabric to match the 3205GN3 and 3221GN3 tripods.....29.95



### SHORT STRAPS

#### Short Grey Strap (BO3044TSB)

An adjustable length 2" wide strap with a single spring clip that attaches to the steel ring at the shoulder of your tripod. It features an adapter for compatibility with all Manfrotto tripods. Comfortable rubberized fabric keeps the tripod from slipping on your shoulder .....33.50

#### Short Green Strap (BO3044TSG)

Same as the above, but in green rubberized fabric to match the Manfrotto 3205GN3 and 3221GN3 tripods.....28.95

#### Short Black Strap (BO3044NAR)

A 1.5" wide adjustable strap supplied with an adapter and a special spring hook which makes attaching and detaching the strap from the tripod easy. It features a double-fixing system whereby the hook attaches to the tripod spider and loops around legs .....29.95



#### Apron Support (BO3146)

Attaches to the tripod legs and allows for storage space beneath the center column. It can also be used to hold a sandbag or stones for extra support. Fits most Manfrotto tripods .....27.95

#### Carbon One Series

##### Carrying Strap (BO3447)

Adjustable length strap for Carbon One tripods. It is supplied with an adapter and a spring hook to easily attach and detach the strap. The strap has a single fixing system, the hook attaches to the tripod spider so that the tripod and head hang down your body. 1.57" width, black color .....31.95

TRIPODS

485



# NOVOFLEX

## MAGICBALL SERIES

TRIPODS

486

The MagicBall Series is a family of revolutionary designed ball and socket heads with an incredible range of almost 120° of adjustment in all directions. Camera positioning is achieved by means of the locking grip. The materials used, virtually eliminate transmission of vibrations to the camera.

The unique MagicBall ball head series consists of three distinctive ball heads that have a fixed positioned ball and a moveable housing. The reverse of traditional ball heads! This unique design allows the camera to be tipped to an inclined position at any point on the head as there is no need for a slot as in traditional designs.



The two largest heads, the MB (The Big One) and the MB 50 (The Universal) have separate tension control as well as the lock for the ball. The locking handle accepts a slip-on cover for use in cold weather. The knurled locking knob can be interchanged with the optional MB Griff (pan handle), a long, rubber covered locking knob when using gloves or additional locking force is required. The smallest version, the MB Mini (The Small) lacks the tension control and does not accept the MB GRIFF or the slip-on cover.

The MB weighs 32.5 oz and supports up to 22 lb. The MB 50 weighs 21.5 oz and supports up to 15.4 lb. while the MB MINI weighs 11.6 oz and supports up to 11 lb. All are equipped with a 1/4"-20 camera screw and a threaded 3/8" tripod socket with a 1/4" reducer. An accessory 360° rotating panorama plate (PANORAMA) with spirit level can be mounted on the top or the bottom (or both) for rotation without using the locking control.

### MB Mini "The Small" (NOMMB)

The small brother can be used on all tripods and is recommended for use with equipment weighing up to 11 lbs. It does not incorporate friction control. Its dimensions are 4.3 x 1.6 x 3", and it weighs 11.6 oz.....**209.95**

### MB-50 "The Universal" (NOMB50)

The MB50 has the handling and the tension control of the MB (The Big One). Although the maximum capacity is lower, it is recommended for use with equipment weighing up to 15.4 lbs. Its dimensions are 6 x 2 x 3.5", and it weighs 21.5 oz.....**274.95**

### MB "The Big One" (NOMB)

The "big" one was the first ball and socket head in the series. Camera positioning is achieved by means of the integrated friction control depending on camera weight. Recommended for equipment weighing up to 22 lbs. Its dimensions are 4.7 x 2.4 x 4.1", and it weighs 32.5 oz.....**329.95**

## NEIGER 19/NEIGER 19P

### Mini Ball & Socket Heads

The Novoflex Neiger 19 and Neiger 19P classic small ball and socket heads are equipped with a 1/4"-20" camera mounting screw and a removable flash shoe so either shoe mount flash or cameras can be mounted to the heads. The Neiger 19 series heads are identical except for the addition of a pan base control on the 19P version. Both are solid metal construction with a pair of convenient rubber rings around the head to ensure a secure grip. Both are capable of carrying the largest of flash units with standard accessory shoe.



**Neiger 19 (NONB19):**  
Small ball head with flash shoe, 1/4" thread (2.2" high, 3.25 oz.).....**29.95**

**Neiger 19P (NONB19P):** Small ball head with flash shoe, 1/4" thread and pan base control (2.6" high, 4.16 oz.) .....**39.95**



For Any Inquiries Regarding Your Order, Call Our Customer Service:  
(800) 221-5743 • (212) 239-7765 • FAX: (800) 947-2215 • (212) 239-7549

# NOVOFLEX

## D IN O

### Pan Tilt Head

Ideal for use with telescopes and monoculars, film and video cameras as well as SLRs and digital cameras, the D IN O (originates from the design — the shape of the letter “D” is inserted “IN” an “O”) is a milestone in the development of pan tilt heads. It offers exceptionally smooth horizontal and vertical panning which can be locked with just one slight turn of the wrist.

The easy handling is a tremendous advantage for the macro specialist. In combination with tripod collar lenses the D IN O

provides adjustment options almost without limit: It becomes a full 3-D-head. Both camera settings, horizontal and vertical, are possible in the 90° position. High stability with low weight, sensitive friction control and 360° panorama rotation make this head unique. It also features a removable grip and video pin.



DinO Silver Pan & Tilt Head (NOPTHs).....239.95

DinO Titanium Pan & Tilt Head (NOPTHt) .....239.95

|      | Camera Threads | Tripod Threads | Height | Weight   | Size without Grip | Maximum Weight |
|------|----------------|----------------|--------|----------|-------------------|----------------|
| DinO | 1/4"           | 1/4" and 3/8"  | 3.5"   | 10.6 oz. | 2.8 x 2.8 x 3.5"  | 6.6 lbs.       |



## MINI, MICRO AND CHEST PODS

### Minipod (NONF3320)

The Minipod offers maximum stability with unprecedented flexibility, which is achieved by the individually variable angles to which each of the legs can be set. Preset positions for angles of 30°, 60° and 90° enable you to adjust the Minipod's position perfectly to any terrain, especially when working at very low levels. Easily supports equipment weighing up to 20 lbs. Maximum height is 7.5", weighs 13.8 oz.....149.50

### Minipod Extension Set (NOE6)

A set of three 6" extensions. It allows you to extend the maximum height of the Minipod an additional 5.9" ....52.95

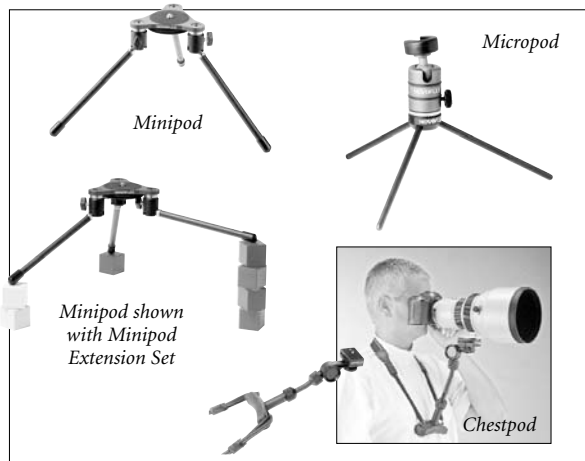

### Micropod (NOMP)

The Micropod is ideal for outdoors or table top photography, as well as for a secondary flash. In combination with the Neiger 19/19P you will be prepared for any situation. It can also be used as a small hand-grip. It extends to 2.8", and weighs 1.8 oz.....24.95

### Chestpod (NOCSP)

The versatile Chestpod is perfect in all photographic and filming situations, where other forms of support are too restrictive. 11.8 x 1.6 x 1.8", it weighs .99 lb ....137.95

TRIPODS

487

# NOVOFLEX

## CLASSICBALL 5

TRIPODS

488

A world first in ball head design, the ClassicBall 5 features three vertical 90° openings for the ball neck; AFC (advanced friction control) system for precisely repeatable and defined friction preset; no fumbling for friction, locking and panning knobs; and absolutely no change of ball position during locking, thanks to the design of the ball interior.

One glance at the ClassicBall 5, with its understated matte titanium finish, and it's clear that this is a high-precision instrument made to last. The ClassicBall 5 is an all-metal design incorporating advanced polymer materials developed and precision manufactured in Germany. In designing the ClassicBall 5, Novoflex engineers drew on practical experience and their deep knowledge of the problems encountered by professional photographers in their daily work. The company has gone to great lengths to achieve high stability and excellent resistance to vibration.



- ◆ Working on the ClassicBall 5, Novoflex engineers aimed first and foremost to meet photographers' requirement for a precisely controllable and repeatable friction adjustment (braking) for the ball. The result was AFC (advanced friction adjustment). Integrated here for the first time, AFC allows photographers to set the friction on a setting ring in the center of the ball head. In other words, they can set the correct braking rate of the ball even before attaching the camera and lens. This means no more trial and error adjustment. Getting the right setting is now child's play, even with weighty telephoto lenses.
- ◆ Completely new, and a world first in ball head design, are three 90° openings to take the ball neck that significantly increase the vertical adjustment range of the head. The camera can now swing smoothly through 180° vertically. Equally important is that three 90° openings have been achieved with no loss of stability.
- ◆ In contrast to other ball heads of this type, the ClassicBall 5 makes it possible to lock the ball in position without any risk of even a slight shift in position. This feature comes into its own in macro photography where it is essential not to disturb the setting of a shot.
- ◆ As one would expect from a product of this caliber, the ClassicBall 5 provides integrated 360° panning and two camera threads (1/4" and 3/8"). The ball support is permanently grease-free.
- ◆ All adjusting elements have been optimized for easy operation even under very difficult conditions. Photographers working in very low temperatures, for example, can set and check all functions reliably without removing their gloves.
- ◆ Weighs 1.9 lbs. and supports up to 26 lbs. of camera equipment. The base diameter is 69mm, the camera-mount diameter is 59 mm and the overall height is 113 mm.

ClassicBall 5 Ballhead (NOCB5) .....499.95

### Panorama Plate Universal Pan Calibrated Base with 1/4" Thread



Only with slow and controlled movements is the professional precision of Novoflex products fully appreciated. Without play or twist, cameras and lenses can be adjusted and positioned exactly.

Substantial tests and decades of photographic experience result in useful accessories like the Panorama Plate. Used between the camera and tripod head or between tripod head and tripod, the Panorama turns smoothly and glides in its base. Equipped with locking screw and spirit level. The Panorama Plate measures 3.5 x 2.4" and weighs 7.4 oz.

Panorama Plate (NOUPP) .....129.95

### Forked Joint "V" Shaped Tripod Head for Long Lenses



The "V" shaped Forked Joint offers additional support when using long lenses, spotting scopes, etc. With the base rigidly attached to a tripod or similar, the fork permits a full 360° turn, allowing the user to continuously follow moving objects without sacrificing the overall stability of the system. The Forked Joint has a height of 4.3", a 4.9" width, and a weight of 7.4 oz.

Forked Joint (NOFJQ).....84.95



EQUIPMENT LEASING AVAILABLE

# NOVOFLEX

## BASICBALL

### A Semi-Ball Becomes a Tripod and More

BasicBall is the solid base for your camera, for the Novoflex D IN O pan-tilt head, the MagicBall, or for any other ball and socket head. The multi-functional base, is a mini-tripod for taking pictures at ground level by using the standard legs, AND a



normal tripod by using the telescope rods, to support your camera, flash, microphone, etc.

Different screw threads for the tripod legs fix the height at 2.4", 5.7", or 8.3". Additional threaded sockets accept additional accessories. The BasicBall is designed for all ground level photography and has a maximum load capacity of 55 lbs.

The use of Novoflex telescope rods transform the BasicBall into a monopod, a duopod or a tripod. In combination with three Novoflex telescope rods, the BasicBall provides an ideal tripod for all trekking tours avoiding excess weight. The variable height with the Novoflex telescope rods reaches from a minimum of 24" to a maximum of 51". This tripod weighs only 2.4 lb. Each Novoflex telescope rod is supplied with a wooden knob to cover the 1/4" tripod thread and a wrist strap. Only the Novoflex telescope rods fit to the BasicBall.

Various available accessories transform the BasicBall into a support for a flash, a microphone or a video light. In addition the BasicBall is perfectly designed for the D IN O and the MagicBall. The BasicBall can also be used as chest pod. The complete set includes a BasicBall with nine 1/4" threads, one 1/4" tripod screw thread, and three tripod legs 7.9" long.

**Blue BasicBall Tripod (NOBBB) .....84.95    Silver BasicBall Tripod (NOBBS) .....84.95**



TRIPODS

489

## BASICBALL ACCESSORIES

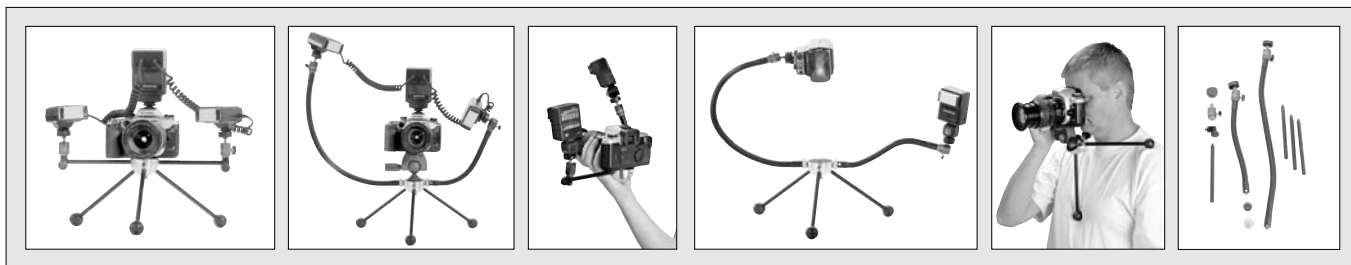

#### Telescope Rods (NOCFRBB)

These Telescopic Roads convert the BasicBall to a tripod (requires 3 rods). Minimum length is 26.7", maximum length is 57". It weighs 10.9 oz .....**84.50**

#### Metal Rod 15cm (NOR15)

With 1/4" threads outside and inside. It measures 5.9" long.....**19.95**

#### Metal Rod 30cm (NOR30)

With 1/4" threads outside and inside. It measures 11.8" long.....**18.50**

#### Novoflex Tripod Extenders (NOE6)

3 extension rods, each 5.9" long .....**52.95**

#### Grip for BasicBall (NOGB)

This grip is like a bicycle handle that screws into the BasicBall's 1/4"-20 threaded sockets. Makes it much easier to carry and control the BasicBall .....**69.95**

#### 90° Angle Connector (NOA90)

Connects one rod or a small ball head to another rod at a 90° angle. For use with the Rod Support System .....**19.95**

#### Novoflex Flexible Arm (NOA)

With a small ball head and flash shoe. It measures 17.7" long .....**74.95**

#### Novoflex Flexible Arm (NOAS)

With a small ball head and flash shoe. It measures 11.8" long .....**64.95**

#### Mini Ballhead with Flash Shoe and 1/4"-20 Thread (NOMBFS)

A very precise small ballhead with an incorporated flash shoe and 1/4"-20 threaded hole .....**39.95**

**ORDER & INFO. (212) 502-6340 • FAX: (212) 239-7770 (800) 947-7008  
1-800-290-6750 • www.bhphotovideo.com**



# NOVOFLEX

## MINICONNECT SYSTEM

TRIPODS

490



### MiniConnect Quick Release Adapter with Plate

Probably the smartest Quick Release System around, MiniConnect provides an outstanding degree of stability, and easy one-handed handling. The coupling pieces are round and small so they can be left on the camera or lens at all times without interference. They are also suitable for the heaviest cameras and lenses. MiniConnect has a safeguard mechanism for the lock which requires a double-action to release the camera.

#### MiniConnect Quick Release Adapter (NONF4010)

Baseplate is 3.1 x 2.4 x 0.7" and weighs 0.31 lbs. Quick release plate diameter is 1", and weighs 0.04 lb. One coupling piece with 1/4" thread is included.....109.95

### MC-Vertikal Angle Bracket for MiniConnect System

The MC-VERTIKAL angle bracket enables a lightning fast change-over from the standard horizontal position to a vertical picture mode.

Therefore it is no longer necessary to make re-adjustment, when changing from horizontal to vertical as you now will keep on working in the same optical axis. It also works with a winder or motor drive on the camera. For convenience, the bracket has a 1/4" thread for attaching to a tripod. thread for a direct connect to the pod.

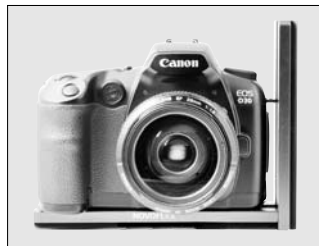

MC-Vertical (NOMCV) .....118.50

### MiniConnect Profiset Quick Release Adapter Set

This set contains the base plate, three coupling pieces with 1/4" thread and a carrying strap. With the strap fitted to the MiniConnect the camera is carried so it is possible to change film without removing the camera from the MiniConnect. Only one strap is necessary to carry the complete outfit. This eliminates the need to fit a strap to the camera itself, which is a particular benefit when switching from carrying the camera to mounting it on a tripod.



MiniConnect Profiset (NOCMCS).....138.95

### Camera Plates for MiniConnect Series



1/4" MiniConnect Coupling Piece (NOCMC14) .....26.50

3/8" MiniConnect Coupling Piece (NOCMC38) .....26.50

1/4" MiniConnect Anti-Twist Coupling Piece (NOPATMC14)  
1/4" coupling piece with an additional lock to prevent unintentional turning. Must be used with cameras or lenses with base plates or tripod connections made of metal.....35.95

3/8" MiniConnect Anti-Twist Coupling Piece (NOPATMC38)  
Same as above except with a 3/8" thread.....28.50

### MiniConnect MR Mini Quick Release



A mini quick release that accepts MiniConnect camera plates. By eliminating the automatic locking function, an extremely practical, small and inexpensive quick release has been developed. The MiniConnect MR fits all small ball

and socket heads, as well as other brackets and mounting accessories. The Mini Quick Release is particularly well suited for small and mid size equipment. Diameter is 2.09", height is 0.79", and it weighs 3oz. Includes a coupling piece with 1/4" thread.

MiniConnect MR (NOMC) .....82.95



# NOVOFLEX

## Q=BASE

### Automatic Quick Release System for Arca Style Plates

Now, for the first time, the Arca system becomes a quick release system rather than a quick mounting system—and it operates with one hand! As soon as a camera or lens with an Arca style plate touches the Q=Base, the base snaps closed, eliminating any possibility of the equipment falling off the base. Besides closing automatically, the Q=Base has a built-in sliding focusing rail feature that allows the camera or lens to slide front to back for precise positioning after it is in the Q=Base. A large knurled base ring locks it securely in place. Built-in safety stops prevent plates from traveling too far. Novoflex also offers a full range of plates for camera and lenses. Plates are available in a variety of lengths and with 1, 2, or more screws. Virtually all currently available Arca style plates fit the Q=Base.



Q=Base Arca-Type Quick Release Adapter (NOQB) .....173.95

TRIPODS

491

### QPL-VERTIKAL

#### Angle Bracket for Q=Base

The QPL-VERTIKAL angle bracket enables a lightning fast change-over from the standard horizontal position to a vertical picture mode.



Therefore it is no longer necessary to make re-adjustment, when changing from horizontal to vertical as you now will keep on working in the same optical axis. It also works with a winder or motor drive on the camera. For convenience, the bracket has a 1/4" thread for attaching to a tripod.

QPL-VERTIKAL (NOQPLV).....106.50

### Q=PLATE Quick Release Plates

Fitting to the Q=Base, Novoflex offers a variety of individual removable plates. Q=PLATES are offered in different lengths, with one or more anti-twist screws. The Q=PLATES use the special safety pin of the Q=BASE to prevent the plates from slipping out of the base. So they have a built-in focusing rail function with the longer plates.

**Standard Plate with 1/4" Thread (NOQPL1):** 1.7 x 1.7". Can mount facing any side ....49.95

**Standard Plate with 3/8" Thread (NOQPL38):** Same as above with 3/8" thread .....CALL

**3.3" Double Top Plate (NOQPL2):** With 1/4" and 3/8" camera screws .....59.95

**4.7" Double Top Plate (NOQPL3):** With 1/4" and 3/8" camera screws .....74.95

**6" Double Top Plate (NOQPL4):** With 1/4" and 3/8" camera screws.....89.95

**2" Anti-Twist Double Plate (NOQPLAT1):** With 1/4" and 3/8" camera screws .....74.95

**2.8" Anti-Twist Double Plate (NOQPLAT2):** With 1/4" and 3/8" camera screws.....89.95



## Focusing Racks for Q=Base System

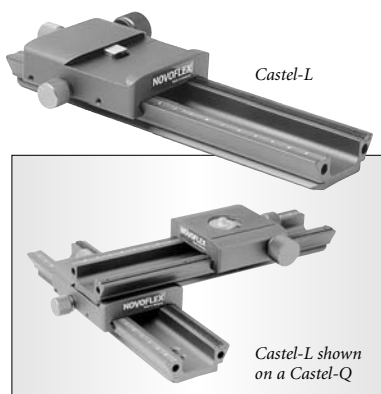

Castel-L

Castel-L shown on a Castel-Q

#### Castel-L Standard Focusing Rack (NOFRS)

For precise adjustments. With improved rigidity and integral quick-release adaptor (MiniConnect System), it can be mounted on a tripod head or a quick-release of the Arca-Swiss type. 7.9 x 3.9 x 1.3" and a maximum adjustment of 5.5" ....229.95

#### Castel-Q Focusing Rack with Dovetail Clamping (NOFRQ):

Combining it with a second Castel-Q, or a Castel-L produces an X-Y focusing rack of unparalleled stability. Its dimensions are 8 x 4 x 1.3", with a camera base width of 66mm. It weighs 16 oz. and has a maximum adjustment of 5.5" .....CALL

#### Castel-XL Heavy-Duty Focusing Rack (NOFRL)

A heavy-duty rack with superior stability and its method of adjustment in 2 planes, resulting in a length of 10.1" and a maximum adjustment of 15". Its dimensions are 10.1 x 4 x 2.4" and it weighs 31.8" .....309.95

#### Castel-Mini Focusing Rack (NOFRSQ)

An invaluable tool for any macro photographer. Two fine-friction drives facilitate the positioning of the entire outfit in relation to the object to be photographed. Dimensions are 5.1 x 3.2 x 2.2", it has 5.3" of total movement, and weighs 9.9 oz.....169.95

ORDER & INFO. (212) 502-6340 • FAX: (212) 239-7770 (800) 947-7008  
1-800-290-6750 • www.bhphotovideo.com





# NOVOFLEX

## BELLOWS

TRIPODS

492

### Automatic Bellows

Using a bellows is the proven path to macro- and microphotography. These auto bellows have connections for automatic diaphragm release and transmission of lens information to permit open-aperture metering. Additionally, the bellows for Minolta AF retains diaphragm control, those for Canon EOS retain all functions, including autofocus. Use the Novoflex 60mm or 105mm Automatic Bellows Lenses, or your own lenses in conjunction with the bellows.

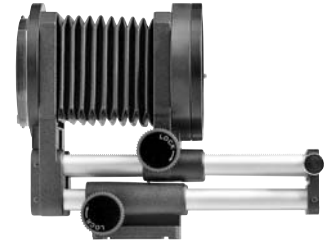

#### Auto Bellows are available for the following cameras:



|                                   |        |
|-----------------------------------|--------|
| Canon EOS (NOBACAF) .....         | 669.95 |
| Canon FD (NOBAFCFD) .....         | 539.95 |
| Minolta Autofocus (NOBAMAF) ..... | 549.95 |
| Minolta MD (NOBAMD) .....         | CALL   |
| Nikon AI (NOBAN) .....            | 669.95 |
| Contax/Yashica (NOBACY) .....     | 539.95 |
| Leica R (NOBAL) .....             | 619.95 |
| Olympus (NOBAO) .....             | 549.95 |
| Pentax (NOBAP) .....              | 549.95 |

#### Automatic Bellows Lens Heads

**Lens Head 4.0/105mm (LEINO-105):** Length 45mm, Diameter: 55mm, Weight: 170g, Operating range: Infinity - 1:1 - 2, Filter size: 52mm. Fitting available for:

|                                |       |              |      |                  |      |
|--------------------------------|-------|--------------|------|------------------|------|
| Canon FD .....                 | Call  | Contax ..... | Call | Leica R .....    | Call |
| Minolta MD .....               | 00.00 | Nikon .....  | Call | Olympus OM ..... | Call |
| M39 with click stop iris ..... |       |              |      |                  | Call |

**Lens Head 4.0/60mm (LEINO-60):** Length 45mm, Diameter: 55mm, Weight: 170g, Operating range: Infinity - 1:2 - 2.1, Filter size: 52mm

|                  |      |              |      |                  |      |
|------------------|------|--------------|------|------------------|------|
| Canon FD .....   | Call | Contax ..... | Call | Leica R .....    | Call |
| Minolta MD ..... | Call | Nikon .....  | Call | Olympus OM ..... | Call |
| Pentax .....     |      |              |      |                  | Call |

#### Slide Copy Attachment with Bellows Lens Hood (NOSCAAB)

The combination of the Bellows Lens Hood with the Slide Copy Attachment results in a slide copier which is perfect for use with the 60mm head .....117.95



### BALPRO 1 Universal Bellows

Due to a complete set of adapters, the BALPRO 1 allows many combinations of different lenses and camera systems. You can not only combine most medium format lenses but also nearly all KB lenses or special lenses with camera bodies up to 6x7. With its compact construction, the BALPRO 1 is also suitable for outdoor photography, and with the EOS-RETRO Reverse Adapter, it becomes a fully automatic bellows for the Canon EOS system.

|  |        |
|--|--------|
| BALPRO 1 Universal Bellows (NOBP1) ..... | 412.95 |
|--|--------|

#### 35mm Camera APRO Mounts for BALPRO 1

|                             |       |                            |       |
|-----------------------------|-------|----------------------------|-------|
| Canon FD (NOCANA) .....     | 79.95 | Canon EOS (NOCANAAF) ..... | 95.95 |
| M42 (NOCOA) .....           | 79.95 | Contax (NOCONTA) .....     | 79.95 |
| Leica-R (NOLEAR) .....      | 79.95 | Minolta MF (NOMINA) .....  | 95.95 |
| Minolta AF (NOMINAAF) ..... | 79.95 | Nikon (NONIKA) .....       | 95.95 |
| Olympus (NOOMA) .....       | 79.95 | Pentax (NOPENTA) .....     | 79.95 |
| Rollei SL35 (NOROLA) .....  | 95.95 |                            |       |

#### 35mm Camera PROLEI Mounts for BALPRO 1

|                              |       |                          |       |
|------------------------------|-------|--------------------------|-------|
| Canon FD (NOLEICAN) .....    | 98.95 |                          |       |
| Canon EOS (NOEOSUNI) .....   | 63.50 |                          |       |
| M42 (NOLEICO) .....          | 54.50 | Contax (NOLEICONT) ..... | 93.50 |
| Leica-R (NOLEIF) .....       | 92.50 | Leica-M (NOLEIM) .....   | 92.50 |
| Minolta MF (PNOLEIMIN) ..... | 92.50 | Nikon (NOLEINIK) .....   | 92.50 |
| Olympus (NOLEIOM) .....      | 92.50 |                          |       |

#### Reverse Adapter for Canon EOS (NOLARCAF)

Open the world of extreme close-up photography to EOS cameras with wide angle or zoom lenses. The lens is mounted on the adapter in reverse position and transmits all lens information to the camera body. Using a 28-105mm EF lens in reverse position allows you to shoot with magnification ratios of 1:7 at 105mm to 2.8:1 at 28mm. No prime macro lens is capable of matching this range. Includes 58mm threads .....349.95



### Ultra Compact Tripods

Compact and versatile minipods, you can even carry a Mini series tripod with your camera attached. Ideal for low angle photography, they can also be used as a chest-pod for added stability, when using slow shutter speeds. All Slik Mini tripods have two-section telescoping legs to make the tripod more stable and get the camera up just a little higher.

Perfect companions for any outing. When folded, the Slik Mini series tripods are about the size of standard telephoto lens, meaning they can be carried in your camera bag all the time so tripod support is always at hand! The bottom of the center column has a suction cup, which can be used to mount a Mini on clean smooth glass surfaces, including windows. Stick the Mini to a window for a higher angle picture or take photos in low light with a slow shutter speed. (Note: The suction cup can't hold up cameras weighing more than 10 oz.)



#### Mini Tripod with 2-Way Panhead (SLMT)

Small and light is what this tripod is all about. The Mini is an excellent and affordable table-top tripod. It has a maximum height of 8.5" and can hold up to 2.5 lbs. with its high impact plastic 2-way head built in. Perfect for positioning and holding a compact digital or film camera for those group photos where a self-timer is used. 2-section telescoping legs make the tripod more stable and get the camera up just a little higher.....**20.95**

#### Mini Pro Tripod with Compact Ball Head (SLMP)

The Mini Pro is built a little more durably than the Mini, comes in a black finish, and uses a removable Compact Ball Head which can handle up to 3.5 lbs. The compact ballhead lets you orient the camera to almost any angle. For vertical photos, the camera platform can be tilted 90° in any direction. It also has an oversized elevator locking collar which makes raising the center column fast and easy.....**36.95**



#### Mini Pro III Tripod with Ball Head (SLMP3)

The same legs as the Mini Pro, the Mini Pro III incorporates a newly designed compact ball head (SBH-100) that is also used on the Sprint and Sprint Pro tripods. The intermediate sized SBH-100 can handle a larger point-and-shoot digital camera, bridge camera or lightweight SLR. Like the Mini-Pro, it also has an oversized elevator locking collar which makes raising the center column fast and easy .....**29.95**

#### Mini Pro V Tripod with 2-Way Panhead (SLMP5)

Same legs as the Mini Pro, the Mini Pro V comes with a removable 2-way pan head with an extended positioning handle. The two-way panhead supports cameras up to 3 lbs. Like the Mini Pro, it also has an oversized elevator locking collar which makes raising the center column fast and easy.....**29.95**



### Compact XL

Sometimes a full sized tripod is more than you need or too much to handle, especially when traveling on vacation. Slik answers your camera support needs with the Compact XL tripod.



The Compact XL with a folded length of less than 16" and under 1.5 lbs., fits almost any suitcase, gadget bag or backpack. The Compact XL trumps the mini-pods class by having a maximum operating height of 43", getting the camera up off the ground. Perfect for compact digital and film cameras, it can hold up to 2.75 lbs. (Note: using SLRs like a Canon Rebel or Minolta Maxxum, the Slik Sprint Pro is the recommended choice for a travel tripod.)

- ◆ Two-way pan head
- ◆ Features reversible head capability for low angle work
- ◆ 4-section legs and a double extension center column extends up to 43"

#### Compact XL (SLCT)

Chrome color.....**29.95**

#### Compact XL (SLCTB)

Black color.....**29.95**

### MINI PRO SPECIFICATIONS

|              | Maximum Height | Minimum Height | Folded Length | Weight     |
|--------------|----------------|----------------|---------------|------------|
| Mini         | 8.46"          |                | 7.9"          | .7 lbs.    |
| Mini Pro     | 9.65"          | 7.9"           | 8.25"         | .73 lbs.   |
| Mini Pro III | 9.64"          | 7.87"          | 8.27"         | 11.65 lbs. |
| Mini Pro V   | 8.58"          | 6.8"           | 7.9"          | 12.6 oz.   |

# SLIK

## U SERIES

TRIPODS

494

### Lightweight Tripods

Light in weight, light in price, but heavy in value, Slik's U Series of economy tripods have proved to be so popular and successful that they have been knocked-off by many companies — but none have been able to match the quality and value performance of these versatile tripods. Every tripod in the series is less than 2 feet long when completely folded and weighs less than 3.5 lbs. Easy to operate, the Slik U Series have many features that the casual photographer and family videographer will come to love.

#### They all Feature:

- ◆ They combine modern design with ultra-smooth controls in a lightweight tripod. Offer distinctive two-tone titanium finish with rounded contours
- ◆ Ultra-smooth geared center column (except the U5500) ensures smooth and quiet rack and pinion gear movement of the center column
- ◆ Oversize, single action, speed release leg locks for quick and simple set up and fold down, adjust the tripod height in seconds.
- ◆ 3-way video/photo fluid effect panhead with locking handle
- ◆ Dual purpose quick release platform for fast, easy mounting and removal of still or video cameras. A dual purpose Quick Shoe attaches easily onto still and video cameras just by aligning along the length of the camera body, and tightening with a coin.
- ◆ Torsion resisting center leg brace for added stability. It also incorporates the movement of all three legs. Just open or close one leg, and the rest will follow automatically.
- ◆ Rubber leg tips provide maximum traction outdoors and protection to surfaces indoors



### SDV and U SERIES SPECIFICATIONS

|                    | SDV-20   | SDV-30    | U5500    | U6600     | U8000    | U9000    | U212     |
|--------------------|----------|-----------|----------|-----------|----------|----------|----------|
| Maximum Height     | 59.5"    | 58.5"     | 56.3"    | 56.3"     | 59"      | 59"      | 63"      |
| Minimum Height     | 21.5"    | 21.5"     | 21.3"    | 21.3"     | 21.5"    | 21.5"    | 24.8"    |
| Folded Length      | 22.8"    | 22.8"     | 22.4"    | 22.4"     | 23.2"    | 23.2"    | 27"      |
| Load Capacity      | 3.3 lbs. | 2.65 lbs. | 3.5 lbs. | 3.5 lbs.  | 4.4 lbs. | 4.4 lbs. | 5.5 lbs. |
| Leg Sections       | 3        | 3         | 3        | 3         | 3        | 3        | 3        |
| Center Column Type | Sliding  | Geared    | Sliding  | Geared    | Geared   | Geared   | Geared   |
| Weight             | 2.4 lbs. | 2.6 lbs.  | 2.2 lbs. | 2.42 lbs. | 3.3 lbs. | 3.5 lbs. | 6 lbs.   |
| Price              | 19.95    | 26.95     | 26.95    | 29.95     | 39.95    | 44.95    | 99.95    |



### SDV-20/SDV-30

These tripods are the ideal choice for a light-weight travel tripod. Compact, lightweight and economical, they feature a 3-way pan & tilt head that can be used with a compact SLR, digital camera or DV camcorder, and includes a quick-release system. The SDV-30 steps-up with a geared center column.

- ◆ 3-way pan head smooth movement of a compact video camera
- ◆ Large, quick release plate for fast, easy mounting and removal of the camera or video camera
- ◆ Speed release leg locks for quick and simple set up and fold down
- ◆ Geared center column with crank to adjust camera height (SDV-30 only)



[www.bhphotovideo.com](http://www.bhphotovideo.com)

# SLIK

## U SERIES

### U212DX 3-Way Video/Photo Tripod

This is the world's most legendary, all-purpose tripod. Designed for use with a wide range of cameras weighing up to 5.5 lbs. Ideal when using slow shutter speeds, flash shots, telephoto or zoom lenses, where absolute steadiness is critical.

- ◆ Rectangular legs maintain torsional strength while retractable rubber leg tips with spikes allow all terrain use. Each leg can be individually adjusted to compensate for unusual surfaces and ground level shots.
- ◆ The quick release camera post is smaller than most quick release plates and can be left on the camera almost all the time.
- ◆ A unique lens calibrated panorama guide eliminates the angular calculations normally required for effective panoramic photos. When using 28mm, 50mm or 100mm lenses, a panoramic series of photos can easily be made by panning from one calibrated guide mark to the next.
- ◆ Geared center column makes fine height adjustments easy. There's even a bubble level to establish accurate positioning.
- ◆ A threaded mounting post on one leg lets you bring the camera down to just 8" from the ground for low angle photos, macro photography in the field, or copy work.
- ◆ Accessory flash holder is available for low-angle shooting and copy work. Also useful to avoid "red-eye" problems by moving the flash away from the camera.



SLU212  
\$99<sup>95</sup>

TRIPODS

495

## SPRINT SERIES

Decades of experience and a wealth of accumulated photographic knowledge, combined with state-of-the-art engineering, have been instrumental in helping Slik create tripods that are amazingly light, yet offer remarkable strength and stability. And the Sprint Series is no exception. Designed as a lightweight solution for the traveling photographer, the Sprint series include a durable ball head and will support the average SLR camera set-up. They weigh under 2 lbs. and fold very compact for effortless travel. When used with the built-in short center column, (the included center column unscrews into two pieces) the camera is just 6.4" off the ground for extremely low angle or macro photography out in the field.

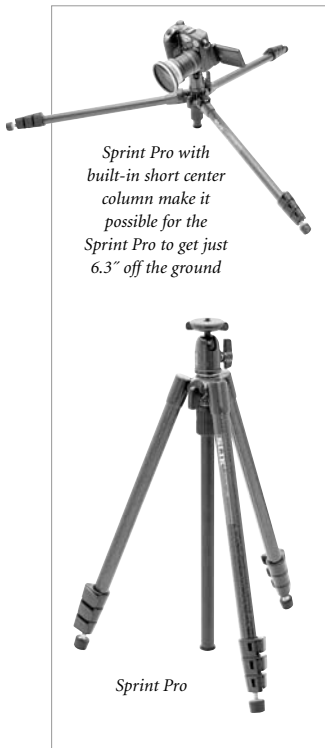

Sprint Pro with built-in short center column make it possible for the Sprint Pro to get just 6.3" off the ground

Sprint Pro

|                        | Mini        | Standard             | Pro                  | Pro 3-Way            |
|------------------------|-------------|----------------------|----------------------|----------------------|
| Maximum Height         | 43.3"       | 63.1"                | 64.3"                | 64.3"                |
| Minimum Height         | 6.4"        | 17.5"                | 6.4"                 | 6.4"                 |
| Folded Length          | 14.2        | 17.9"                | 18.9"                | 18.9"                |
| Load Capacity          | 3.5 lbs     | 4.4 lbs              | 5.5 lbs              | 5.5 lbs              |
| Leg Sections           | 4           | 4                    | 4                    | 4                    |
| Independent Leg Spread | Yes         | Yes                  | Yes                  | Yes                  |
| Center Column Sections | 2           | 1                    | 2                    | 2                    |
| Center Column Type     | Sliding     | Sliding (Reversible) | Sliding (Reversible) | Sliding (Reversible) |
| Leg Lock Type          | Flip Levers | Flip Levers          | Flip Levers          | Flip Levers          |
| Head Mount Thread Size | 1/4-20"     | 1/4-20"              | 1/4-20"              | 1/4-20"              |
| Weight                 | 1.6 lbs     | 1.9 lbs              | 1.9 lbs              | 1.9 lbs              |

- Sprint Silver Mini Tripod (SLSMS) .....59.95
- Sprint Silver Pro Tripod (SLSPS) .....79.95
- Sprint Gunmetal Black Mini Tripod (SLSMB).....59.95
- Sprint Gunmetal Black Pro Tripod (SLSPB) .....79.95
- Sprint Silver Standard Tripod (SLSS) .....69.95
- Sprint Gunmetal Standard Black Tripod (SLSB) .....69.95
- Sprint Gunmetal Black Tripod with 3-way Head (SLSPBQ).....84.95

ORDER & INFO. (212) 502-6340 • FAX: (212) 239-7770 (800) 947-7008  
1-800-290-6750 • www.bhphotovideo.com



# SLIK

## PRO SERIES

TRIPODS

496

### 300DX

Built with the photo enthusiast in mind, the 300DX combines many design advances in this utility tripod. The legs of the 300DX set up and fold down securely, just loosen and tighten the leg lock knob to extend or shorten them. 3 position adjustable angle leg locks make for easy set up on uneven ground or steps. These leg locks also allow the height of the tripod to be lowered. Combine this feature with the optional 300DX Short Column and the tripod can be lowered to just 14" the for very low angle or macro photography in the field.

For even lower angle photography or copy work, the standard gearless center column can be reversed (turn upside down) so that the head is at the bottom of the center column, giving you the ability to photograph with the camera just a few inches off the ground.



#### 300DX Pan Head

The 300DX tripod comes with the compact 300DX Pan Head. Made from solid, precision-machined aluminum, this all-metal head has the strength and durability to handle a wide variety of digital and 35mm cameras and lenses. The 3-way pan head has a metal quick release plate that positively locks into the head. One lever operation of the quick release lock allows fast mounting and un-mounting of the camera.

### Pro 330DX with 3-Way Pan Head

Available in black or natural A.M.T. super alloy finish, the compact and easy-to-carry Pro 330DX has the strength and versatility of a larger studio tripod. It supports cameras up to 9 lbs. making it perfect for the photographer with a digital camera or lightweight SLR camera and lens. Plus the head is removable, so that a variety of other heads, like one of the Slik ball heads, can be used in place of the included all-metal 3-way pan head with quick release. The emphasis on the Pro 300 DX is ease of use. Set-up is easy with secure, yet fast speed release (lever) leg locks, gearless center column for quick height adjustments and 3-position adjustable angle legs.



- ◆ Slik's exclusive A.M.T. super titanium alloy legs make the Pro 330DX lighter than similar tripods, but with more rigidity for a more secure hold on your camera. It also makes the Pro 330DX an economical alternative to more expensive carbon fiber tripods.
- ◆ Using Tri-Tanium, a super-strength, aerospace alloy comprised of aluminum, magnesium and titanium (A.M.T.), the tripod has a strength-to-weight ratio more than 40% greater than comparable tripods, while allowing the tripod to be 25% lighter in weight.
- ◆ 3-way pan head with quick release camera mount, as well as precise, individual locking controls for pan and tilt movements.
- ◆ Has an easy-to-grasp oversized locking collar, sealed-channel "D" shaped leg extension segments, gearless center column and individual 3-position leg angle adjustment.
- ◆ Special rubber leg tips provide maximum traction outdoors.
- ◆ The leg angle locks allow you to set the tripod to 3 different height positions. Each lock is independent, so you can set up quickly and easily on steps, or uneven terrain. The adjustable angle can also be used to lower the camera for extremely low angle or macro photography out in the field.
- ◆ Lever Lock, the easiest to use leg lock. Lift lever to unlock, push lever to lock. It lets you extend or shorten a leg without taking your eyes off your subject.
- ◆ Folds down small to just 23.5", extends to a maximum height of 63" and weighs just 3.3 lbs. making it great for traveling.

**Pro 330DX Black (SLP330DXHB) .....89.95**

**Pro 330DX Titanium (SLP330DXHT) .....89.95**

**Short Column for 330DX (SLCCSP330DX): A short center column for the lowest possible camera angle with the legs fully spread.....13.95**



## PRO SERIES

### Pro 400DX with 3-Way Pan Head and Circular Quick Release

The Pro 400 DX is an all-metal tripod, which is more than suitable for digital or 35mm SLR cameras and medium format cameras. It has the same features as the Pro 330DX (except the all-metal construction vs. alloy), it adds soft grip padded legs and has a short center column built in. Just unscrew the column into two pieces and it becomes 6.5" shorter. That allows the camera to be only 14" off the ground with the legs at their lowest position.

- ◆ Speed release leg locks make the Pro 400 DX a breeze to set up and take down.
- ◆ Folded length of just 25" and soft grip padded legs, make this lightweight tripod even easier to carry.
- ◆ The head is removable, so that a variety of other heads can be used in place of the included 3-way pan head with quick release plate.
- ◆ Despite its lightweight it supports up to 10 lbs.
- ◆ 3-position leg angle locks allow lowering the tripod to for very low angle or macro photography work. Just unscrew the built-in short center column into two pieces and it becomes 6.5" shorter. That allows the camera to be only 14" off the ground with the legs at their lowest position.



**Pro 400DX Tripod with 3-Way Pan/Tilt Head (SL400DXPH) .....109.95**

TRIPODS

497

### PRO SERIES SPECIFICATIONS

|                    | Able 300DX | Pro 330DX | Pro 400DX | Pro 700DX |
|--------------------|------------|-----------|-----------|-----------|
| Maximum Height     | 61"        | 63"       | 61"       | 74.8"     |
| Minimum Height     | 18.5"      | 18.5"     | 13"       | 24.4"     |
| Folded Length      | 25.8"      | 23.6"     | 25.6"     | 29.9"     |
| Load Capacity      | 11 lbs.    | 6.63 lbs. | 11 lbs.   | 15 lbs    |
| Leg Sections       | 3          | 3         | 3         | 3         |
| Center Column Type | Sliding    | Sliding   | Sliding   | Sliding   |
| Weight             | 5.75 lbs.  | 3.31 lbs. | 5.8 lbs.  | 7 lbs     |



**Pro 700DX Tripod with 3-Way Pan/Tilt Head (SL700DX) .....129.95**

### PRO 700DX with All-Metal 3-Way Pan Head

Capable of handling the weight of heavy, long telephoto lenses, the PRO 700 DX offer professional photographers and advanced amateurs the strength and stability they need while it's size, and the use of A. M. T. alloy, make it light and very portable.

#### Step-up Features (from the PRO 400 DX):

- ◆ Slik's exclusive A.M.T. super titanium alloy legs make the PRO 700 DX tripod rocksteady yet lighter than it looks. The A. M. T. alloy has a 40% greater strength to weight ratio than standard aluminum, meaning the legs are lighter weight yet stronger than the standard metal used in most of today's tripods.
- ◆ "Lift-n-lock" center column with dual locking control
- ◆ Supports cameras up to 15 lbs.
- ◆ Reversible head attachment screw on the center elevation post lets you use head with either large or small screw holes
- ◆ Minimum camera height is 22" with standard center column. Optional short center column allows the the tripod to be lowered to just 15" above ground for very low angle, or macro photography in the field.
- ◆ The all-metal 3-way pan head has one of the fastest and easiest to use quick release plates in the industry. The circular quick release plate can secure the camera to the tripod pointing in any direction, making attaching your camera (once the quick release plate is attached) more intuitive than most other heads that have squared off or angled plates.
- ◆ Dual axis bubble level (2 bubble levels) for easy leveling, recessed against damage.



# SLIK

## PROFESSIONAL CARBON FIBER SERIES

TRIPODS

498

### The Stealth Tripods

The PRO 713 CFII, PRO 813 CFII, PRO814 CFII and PRO 883 CF-D take carbon fiber to new heights of lightweight portability, while being the most inexpensive carbon fiber tripods available! Perfect for 35mm and digital camera owners, even medium format users will appreciate their ultra light weight. The feature dual 1/4" and 3/8" mounting studs on both ends of their center columns, multi-angle leg adjustments for use on uneven terrain and can operate at a height of 12" without the need of the short center column.

- ◆ Made from an advanced multi-layered carbon fiber material, which is approximately 40% lighter than the equivalent aluminum, they weigh under 4 lbs. But that is not the only advantage. With their three telescoping leg sections (4 on the 814 CF) they fold to a compact 19-23" making them even easier to carry. The PRO 883 CF-D uses D shaped carbon fiber tubing to prevent legs from turning when setting-up or folding down.
- ◆ They have 3-position adjustable angle legs locks for easy set up on uneven ground or steps. These leg locks combined with the optional (supplied with the PRO 883 CF-D) short column allow the tripods to be lowered to just 7" for extreme low angle or macro photography in the field.
- ◆ You can invert the center column to get an extremely low angle shot. By reversing the center column, combined with the adjustable angle legs locks, the camera can be positioned just an inch or two off the ground! It's an excellent technique for copying flatwork such as photographs as well.
- ◆ Each of the carbon fiber tripods have a patented double nut ring twist lock on each leg section to tighten the leg securely to hold up to 10 pounds of camera gear.
- ◆ The PRO 883 CF-D has Slik Speed-release Leg Locks. Instead of using a twist lock, the Speed-release lock has a one-lever operation that makes setting-up and folding down very fast and easy.
- ◆ Each tripod has padded "Leg Wraps" around the top leg section. The padded wraps make carrying the tripod much more comfortable and add a mere 4 oz to the weight of each tripod, keeping them feather-light for easy traveling.

- Pro 713 CF II (SLP713): 3-Section Carbon Fiber Tripod .....249.95
- Pro 813 CF II (SLP813): 3-Section Carbon Fiber Tripod .....279.95
- Pro 814 CF II (SLP814): 4-Section Carbon Fiber Tripod .....299.95
- Pro 883 CF-D (SLP883): 3-Section Carbon Fiber Tripod.....379.95



### STEALTH TRIPOD SPECIFICATIONS

|                    | Pro 713 CF II | Pro 813 CF II | Pro 814 CF II | Pro 883 CF-D |
|--------------------|---------------|---------------|---------------|--------------|
| Maximum Height     | 60.2"         | 65.1"         | 63.1"         | 57.5"        |
| Minimum Height     | 12"           | 11.8"         | 12.2"         | 8.66"        |
| Folded Length      | 22.6"         | 23.4"         | 19.2"         | 25.5"        |
| Load Capacity      | 10 lbs.       | 12 lbs.       | 12 lbs.       | 13.5 lbs     |
| Leg Sections       | 3             | 3             | 4             | 3            |
| Center Column Type | Rapid         | Rapid         | Rapid         | Geared       |
| Weight             | 2.75 lbs.     | 3.4 lbs.      | 3.4 lbs.      | 7 lbs        |



For Any Inquiries Regarding Your Order, Call Our Customer Service:  
 (800) 221-5743 • (212) 239-7765 • FAX: (800) 947-2215 • (212) 239-7549

## COMPACT CARBON FIBER SERIES

### Pro 613 CF / Pro 614 CF

The new Compact Carbon Fiber Series tripods use space-age carbon fiber material to reduce weight and improve rigidity for a more stable camera support. The Pro 613 CF folds down to an incredibly small 16.3" and weighs 1.5 lbs, while the Pro 614 CF folds down to 17.9" and weighs 2 lbs.

They both have Twist-Lock Leg Locks to insure sturdy camera support. These legs allow them to support up to 6.6 pounds of camera equipment. These tripods are excellent travelers, and they include a tripod bag that makes carrying them more comfortable.

For low angle photography the PRO 613 CF and PRO 614 CF have SLIK multi-angle leg locks that allow the angle of each leg to be positioned individually. Combined with the included short column, the PRO 613 CF can be lowered to just 4" from the ground (4.35" for the PRO 614 CF). The multi-angle leg locks allow easy set-up and positioning on uneven ground or steps.

**Pro 613 CF (SLP613):**  
3-Section Carbon Fiber Tripod with a 47.4" maximum height and 3.9" minimum height.....**239.95**

**Pro 614 CF (SLP614):**  
4-Section Carbon Fiber Tripod with a maximum height of 61" (eye level), and a minimum height of 4.35" .....**259.95**



TRIPODS

499

### COMPACT CARBON FIBER SERIES

|                         | Pro 613 CF  | Pro 614 CF   |
|-------------------------|-------------|--------------|
| Maximum Height          | 47.4"       | 61.2"        |
| Minimum Height          | 3.9"        | 4.35"        |
| Folded Length           | 16.3"       | 17.9"        |
| Load Capacity           | 6.6 lbs.    | 6.6 lbs.     |
| Leg Sections            | 3           | 4            |
| Center Column Extension | 11.8"       | 11.8"        |
| Weight                  | 1 lb. 9 oz. | 1 lb. 14 oz. |

## TRIPOD ACCESSORIES



### Clamp Head 38 (SLCH38)

Attached to a tripod leg or light stand, the clamp head will hold a camera rock-steady on an otherwise impossible angle. It can be adjusted a full 360° horizontally and 180° vertically. Attach it to the lower part of a tripod leg for low level shooting, or to the upper portion of the leg or center column to mount two cameras on a single tripod. Its load capacity is 11 lbs., the platform size is 3.25 x 2" and it weighs 1.2 lbs .....**49.95**

### Medium Tripod Case (SLTCM)

Made of heavy-duty material. It has an extra outside pocket, special ID window and adjustable carry strap. 24 x 6.3 x 5.1" .....**14.95**

### Large Tripod Case (SLTCL)

Same as the Medium Tripod Case, but in a larger size. 30 x 9.5 x 8.3" .....**19.95**

### U700 Universal Dolly (SLDU700)

Individual leg holders lock your tripod securely in place and adjust to allow the use of virtually any size tripod. Oversized 3" rubber wheels provide smooth rolling action, and individual wheel locks secure tripod in place. Folds for easy carrying. Handy carry strap included. Legs are all metal construction. Opens to 19.4", folds to 21 x 3.6 x 5.6" and weighs 7.7 lbs .....**109.95**



# SLIK

## PROFESSIONAL SERIES

TRIPODS

500

*Designed for the professional photographer that won't compromise, where durability and steadfastness overshadow other concerns. The Pro Series is a family of workhorse camera supports with ultra heavy-duty construction. Use them with large format cameras (4x5, 8x10), medium format, or digital SLRs and 35mm cameras with long heavy telephoto lenses. Photographers that don't travel light will find the heavy metal construction of these tripods more than adequate. With professional features like worm gear elevation of the center column, all metal leg and joint construction, and the ability to hold up to 22 pounds of properly balanced equipment, these tripods will give years of unyielding service.*

- With a height of 78 1/2" (that's 6' 6" off the ground!) the **Professional** can handle just about any shooting situation where absolute stability is required.
- For those who need less height and lighter load capacity, the **Professional II** supports up to 15 lbs. and has a maximum working height of 72 1/4". With a folded length of 37 inches, this tripod makes taking this kind of durability on the road just a little bit easier.

- For those who need to get above the crowd, the **Professional 4** will elevate your camera to new heights. With a maximum working height of 99.5" (that's 8 1/4") this solid draft horse of a tripod will empower you to experience a new higher perspective in your photography.

- Made of heavy duty construction, they are designed to shrug off the abuses of professional use, allowing you to concentrate on creativity while assuring you of a rock-solid base for sharp, magnificent images.
- 3-position leg angle adjustment locks allow you to set the tripods to 3 different height positions. Each lock is independent, so you can set up quickly and easily on steps, or uneven terrain.
- Rugged, round tubular legs are grooved, so unlike standard tubular legs, they won't turn while you're tightening or loosening the leg locks of any section. Allows simple and secure locking and lets you extend the leg from any section, regardless of the order.
- Oversized, "Sof-Touch" rubber contoured leg locks fit and feel pleasant. They let you lock securely with minimum force.
- By exchanging the center elevation column with the optional short center column you can go very low. Makes it ideal for macro, copy work and low angle applications.
- The professional series can be used with a wide variety of cameras. The reversible head attachment screw on the center elevation post lets you use heads with either large or small screw holes. The screw not in use fits into the side of the head where it's out of the way but always handy.

- 10 cm indexed reference marks on each second leg section permit precise leg height adjustments, while the specially designed rubber leg tips keep the tripod balanced, and stable, by always maintaining plane contacts with the ground.

- Precision worm gear elevation center columns provide for critical elevation control. The positive worm gear design assures that there is no slippage or drifting, with heavy equipment, even if the center column is left unlocked.



### The Professional Head

*Every bit as important as the legs is the tripod head. the Professional Pan Head is a solidly constructed 3-way pan head with the features that uncompromising photographers are looking for.*



- Large built-in camera platform to handle the mount bases on 4x5 and 8x10 view cameras.
- The head has dual axis bubble levels for easy accurate leveling of your camera. The bubble levels are recessed in the camera platform to protect against being damaged.
- This head has both large (3/8-16) and standard (1/4-20) threaded camera mounting posts. When one is not in use, the post fits into a socket in the side of the head where it is out of the way yet always available.

|  |        |
|--|--------|
| <b>Professional 3-Way Panhead (SLPH):</b>                              |        |
| For the Professional and Professional 4 tripod.....                    | 154.95 |
| <b>Professional II 3-Way Panhead (SLP2H):</b>                          |        |
| Same as above, but scaled to work with the Professional II tripod..... | 124.95 |



**ONE HOUR FREE PARKING**  
AT 349 W. 34th STREET (with purchase of \$100 or more)

## MASTER CLASSIC SERIES

The best materials and an easy-to-use design, has established the Master Classic as an enduring tradition among camera supports. Day in, day out, the Master Classic continues to provide solid and reliable camera support for photographers worldwide. Harkening back to the founding days of the company, the Master Classic features durable all metal leg and joint construction, secure twist lock legs with a texture grip finish on the locking rings for easy operation, and a geared center column for precise height adjustments. The ability to support over 12 lbs. makes it excellent for digital and 35mm SLR cameras with long telephoto lenses.

### Master Classic Head

- ◆ The 2-way pan head has traditional all-metal construction with simple sturdy one lever operation. When released, the head can move in two directions, it can tilt up and down and pan left or right. These directions of movement make the head an ideal choice for long telephoto lenses, like 300mm f/2.8, 400mm f/5.6 or 500mm f/4.5. Following a subject, such as a bird in flight, is easy with this head. The tension of movement can be adjusted by turning the release lever slightly to match the weight of the camera and lens being used.
- ◆ The camera mount plate, while not removable, has a small release lever on one side that allows the mount plate to rotate 360°; and be locked down at any point.
- ◆ The camera mount post is spring-loaded and can be adjusted by turning the tensioner to match the tread depth of the lens or camera being used. This allows for more secure mounting of heavy equipment on the head.



TRIPODS

501

### PROFESSIONAL SERIES AND MASTER CLASSIC SPECIFICATIONS

|                    | Professional | Professional II | Professional 4 | Master Classic              |
|--------------------|--------------|-----------------|----------------|-----------------------------|
| Maximum Height     | 78.8"        | 72.3"           | 99.5"          | 64"                         |
| Minimum Height     | 23.2"        | 23.3"           | 23.2"          | 24.2"                       |
| Folded Length      | 40.9"        | 31.9"           | 42.3"          | 25.5"                       |
| Load Capacity      | 22 lbs.      | 16 lbs.         | 22 lbs.        | 13.2 lbs                    |
| Leg Sections       | 3            | 3               | 4              | 3                           |
| Center Column Type | Worm Gear    | Worm Gear       | Worm Gear      | Geared with tension control |
| Weight             | 13.9 lbs.    | 7 lbs.          | 15.2 lbs.      | 5.5 lbs.                    |

Professional Tripod (SLP) .....399.95    Professional II Tripod (SLP2L) .....234.95    Professional II Tripod with Pro II Panhead (SLP2) .....349.95  
 Professional 4 Tripod with Pro Head Panhead (SLP4) .....499.95    Master Classic Tripod (SLMC) .....139.95

### QUICK RELEASE PLATES

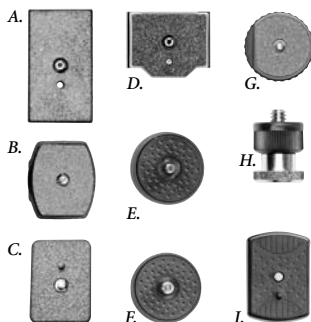

- A. Quick Release Platform for the 504QF II (SLQRP503QF) .....9.95
- B. Quick Release Platform for the ABLE 300 DX (SLQR300DX) .....14.95
- C. Quick Release Platform for the E-Z Pod (SLQRSEZP) .....9.95
- D. Quick Release Platform for the 505QF (SLQRS505QF) .....13.95
- E. Quick Release Platform for the Pro 700 DX and Ballhead 800 (1/4-20 mount) (SLQR.25PB800) .....14.95
- F. Quick Release Platform for the Pro 700 DX and Ballhead 800 (3/8 mount) (SLQR38P800) .....19.95
- G. Quick Release Platform for the AF-2100 Triger Release Ballhead (SLQRP112AF) .....13.95
- H. Quick Release Post for the U212 (SLQRP) .....6.95
- I. Quick Release Platform for the U9000, 8000, 6600 (SLQRSU8000) .....9.95

## BALL HEADS

### **AF 2100 Pistol Grip Head**

The world's original, and most popular trigger-style ball head, the patented and award-winning AF 2100 takes photography on a tripod to a new level. The key is in the trigger handle.

It has an over sized trigger release that you squeeze to release and freely move the head. When you have moved your camera to the desired position, just release the trigger and the ball head locks firmly into place, at any angle. This smooth and natural movement makes the ball head feel like more on an extension of our hand than any other ball head available.



- ◆ Use with all makes and models of tripods with 1/4"-20 or 3/8"-16 threaded center column posts. Quick release plate allows fast action mounting or removal of the camera platform. Base diameter is 2.0"
- ◆ The AF 2100 handle is large enough for photographers with large hands to have a solid grip, but sized so that those with smaller hands will be able to use it with comfort and ease.
- ◆ Capable of handling more than 10 lbs. of equipment, the AF 2100 can easily support a 300mm f/2.8 lens with a heavy pro camera body.
- ◆ A convenient thumb switch on the handle locks and unlocks the quick release shoe, which means that circular quick release plate can rotate over 220° and be locked at any point. There is also a separate safety release button so that the quick release plate can only be removed from the head when it is pressed. Your camera is securely attached to the AF 2100 until you decide to remove it.

### **PRO 700 DX 3-Way Head**



Made from solid, precision-machined aluminum, this all-metal, 3-way pan head that has the strength and durability to handle a long telephoto lens such as a 300 f/2.8 or 80-400mm zoom lens.

The PRO 700 DX is revolutionary because of its unique quick release system, one of the fastest and easiest to use in the industry. Slik created a circular quick release plate that can be secured to the

tripod with the camera pointing in any direction, making attaching your camera (once the Slik quick release plate is attached) more intuitive than most other heads. This is unlike squared off or angled plates which allows the camera to be attached, in one, or at most two positions. With speedy mounting of the camera to the head meaning you can be ready to shoot in less time.

For leveling of the camera, the head has dual axis bubble levels recessed in the quick release's mount base so the camera can be easily leveled once it is attached. It has a standard 3/8" mount so that it can be used with tripods from other manufacturers as well.

### **Ball Head 800**

A medium size ballhead with tension control and built-in quick release which can be used with medium format cameras (with standard lenses) as well as 35mm cameras with most telephoto lenses, the Ball Head 800 is strong, sturdy, and easy to use. Handles loads up to 11 lbs.



- ◆ Using the same quick release system as the PRO 700 DX tripod head, the Ball Head 800 has one of the fastest and easiest quick release plates in the industry.
- ◆ The circular quick release plate secures the camera to the tripod pointing in any direction, making it easier to attach your camera than other heads that have squared off or angled plates.
- ◆ Precision machining, polishing of all moving parts and an over-sized, easy grip release knob for fine tension adjustments.

### **Standard Ball Head II**



Simple, reliable and inexpensive. Created from precision machined aluminum components and advanced high impact polymers, the Standard Ball Head II will yield years of trustworthy service. Handles up to 5 lbs.

- ◆ Large, circular mount area gives your camera the proper support while the free turning anti-scratch plate within the head will protect the bottom of your camera from damage. Also reduces the likelihood that your camera could get jammed on the head.
- ◆ The perfectly sized release lever makes releasing and locking the head in any position very convenient and easier to use than other ball heads having small release knobs which can be over tightened and make fine tension adjustments difficult.

### **Compact Ball Head**

Scaled down in size, not in quality, the Compact Ball Head matches perfectly with today's compact cameras. Using a combination of aluminum and high-impact polymers, the head supports an impressive 3.5 lbs., while providing years of dependable service.



- ◆ Knurled locking lever and camera mount provide extra grip, making it easy to mount and un-mount the camera from the ball head.
- ◆ An optimum sized circular mount gives your camera the proper support while the free turning anti-scratch plate within the head ensures the bottom of your camera isn't damaged and greatly reduces the likelihood that your camera gets jammed on the head.

## BALL HEADS

### SBH-60, SBH-100 and SBH-120 Economical and Compact Ball Heads

Very similar in design, Slik's economical and compact ball heads differ in size and load capacity. They have an easy to operate one lever release that allows the ball head to move and then locks it into place when the camera is at the desired position. Differing themselves from many inexpensive ball heads on the market, the base of these heads can rotate in addition to the ball movement. This makes horizontal movement of the camera much easier.



Benefiting from all metal construction, these heads will be able to handle many years of normal use.

The SBH-60 is the smallest of the series and is designed primarily for compact lightweight point-and-shoot digital and film cameras. The intermediate sized SBH-100 can handle a larger point-and-shoot digital camera, bridge camera or lightweight SLR. The SBH-120 is designed for light to intermediate weight SLR cameras.

### SBH-280, SBH-320 and SBH-550 Professional Ball Heads

Slik's professional ball heads are made from finely machined and carefully anodized hardened aluminum parts that are designed to give many years of trouble-free smooth operation. The heads feature an easy to use, single knob operation to lock or release the ball connected to the camera plate. The knob is oversized and has a well-textured surface for a sure grip in any conditions.



When the head is released, not only does the ball portion of the head move freely, the main body encasing the head can turn on its base for quick and easy movement as well. The base of the head has easy-to-read degree marking for panoramic photography.

The SBH-280 is capable of handling a digital SLR or 35mm film cameras. The SBH-320 is recommended for medium format cameras and can be used with digital backs or telephoto lenses. The SBH-550 can handle long telephoto lenses and 4x5 field or view cameras.

|   |       |  |        |
|---|-------|--|--------|
| <b>AF 2100 Pistol Grip Head</b> (SLAF2100)..... | 79.95 | <b>SBH-100 Compact Ball Head</b> (SLBHC100) .....      | 19.95  |
| <b>PRO 700 DX 3-Way Head</b> (SL700DXPH) .....  | 59.95 | <b>SBH-120 Compact Ball Head</b> (SLBHC120) .....      | 29.95  |
| <b>Ball Head 800</b> (SLBHP800).....            | 79.95 | <b>SBH-280 Professional Ball Head</b> (SLBHP280) ..... | 99.95  |
| <b>Standard Ball Head II</b> (SLBHS2) .....     | 49.95 | <b>SBH-320 Professional Ball Head</b> (SLBHP320) ..... | 129.95 |
| <b>Compact Ball Head</b> (SLBHC) .....          | 29.95 | <b>SBH-550 Professional Ball Head</b> (SLBHP550) ..... | 159.95 |
| <b>SBH-60 Compact Ball Head</b> (SLBHC60) ..... | 16.95 |  |        |

### BALL HEAD SPECIFICATIONS

|                       | Load Capacity | Tripod Mounting Screw                   | Weight    | Height |
|-----------------------|---------------|---|-----------|--------|
| AF 2100               | 10 lbs.       | Dual 1/4"-20 and 3/8"-16                | 1.88 lbs. | 5.3"   |
| Pro 700 DX            | 15 lbs.       | 1/4"-20                                 | 2.2 lbs.  | 4.7"   |
| Ball Head 800         | 6.6 lbs.      | 3/8"-16 (with removable 1/4"-20 insert) | 1.6 lbs.  | 4.7"   |
| Standard Ball Head II | 11 lbs.       | 1/4"-20                                 | 0.66 lbs. | 3.9"   |
| Compact Ball Head     | 6.5 lbs.      | 1/4"-20                                 | 0.29 lbs. | 3.2"   |
| SBH-60                | 1.25 lbs.     | 1/4"-20                                 | 1.7 oz.   | 1.9"   |
| SBH-100               | 3.5 lbs.      | 1/4"-20                                 | 3.5 oz.   | 2.5"   |
| SBH-120               | 4.5 lbs.      | Dual 1/4"-20 and 3/8"-16                | 4.6 oz.   | 2.95"  |
| SBH-280               | 11 lbs.       | 3/8"-16 (with removable 1/4"-20 insert) | 0.54 oz.  | 3.7"   |
| SBH-320               | 15.4 lbs.     | Dual 1/4"-20 and 3/8"-16                | 11.9 oz.  | 3.95"  |
| SBH-550               | 22 lbs.       | Dual 1/4"-20 and 3/8"-16                | 0.8 oz.   | 4.6"   |



# SLIK

## MONOPODS

Although a Monopod cannot stand by itself, it gives you an easy, go-anywhere support system for your camera, and eliminates that undesirable vertical movement created when your camera is hand-held. Your pictures are sharper and clearer. Lighter and more compact than a tripod, Slik monopods offer greater mobility for covering fast-moving action.

### Pro Pod 381 CF

Whether a professional nature photographers or a photographer that travels a lot, you will benefit from the amazing abilities of carbon fiber and the Pro Pod 381 CF.

- ◆ Made from an advanced multi-layered carbon fiber material, approximately 40% lighter, but just as rigid as the equivalent aluminum, the Pro Pod 381 CF weighs less than a pound without head! It also folds down to less than 20" in length.
- ◆ Small size and featherweight makes it a natural on any photo backpack, you'll almost forget it's there!
- ◆ Has a patented double nut ring twist lock on each leg section to tighten the leg securely to hold up to 10 pounds of camera gear.

**Pro Pod 381 CF (SLPP381CF).....129.95**

### Pro Pod 600

Slik's exclusive A.M.T. super titanium alloy legs make the Pro Pod 600 rock solid steady yet lighter than it looks. The A. M. T. alloy has a 40% greater strength to weight ratio than standard aluminum, meaning the tubing used in this monopod is lighter weight yet stronger than the standard metal used in any of today's monopods.

- ◆ 4 leg section design folds down to a very compact 21" but when fully extended the monopod is 63" tall before adding a ball head (heads are optional).
- ◆ Capable of handling heavy professional SLR cameras and long telephoto lenses up to 800mm, the PRO POD 600 is perfect for sports or nature photography.
- ◆ Grooved tubular leg extends smoothly and will not turn while leg locks are tightened or loosened.
- ◆ Firm-grip surface provides a strong hold in any weather conditions while the wrist strap can be used to further the stability of the monopod.
- ◆ Speed release leg locks make setting up easy, fast, and secure.

**Pro Pod 600 (SLPP600).....79.95**

### Mono Pod 350

Lighter than the Pro Pod 600, the Mono Pod 350 is designed for use with lighter cameras.

- ◆ 4 leg section design folds down to a very compact 20" but when fully extended the monopod is 63" tall and weighs less than 1 pound before adding a ball head.
- ◆ The lightweight aluminum leg sections have an indented groove that prevents the individual sections from turning during set-up or folding down, keeping the leg sections perfectly aligned.
- ◆ Speed release leg locks make setting up easy, fast, and secure.
- ◆ Includes padded grip & swivel carry strap

**Mono Pod 350 (SLM350).....29.95**

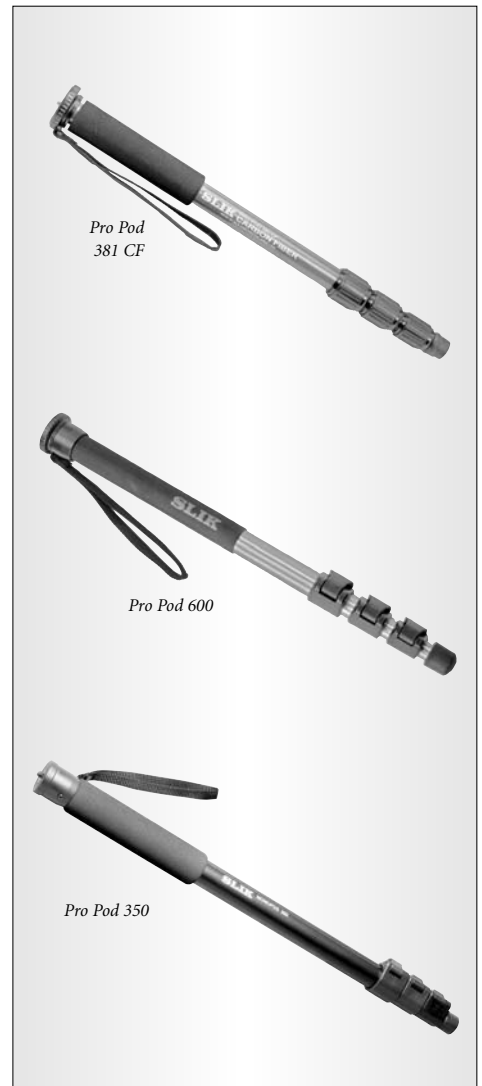

### PRO POD SPECIFICATIONS

|                | Maximum Height | Folded Length | Load Capacity | Leg Sections | Leg Lock Type | Head Mount Thread | Weight    |
|----------------|----------------|---------------|---------------|--------------|---------------|-------------------|-----------|
| Pro Pod 381 CF | 63.1"          | 19.7"         | 11 lbs.       | 4            | Twist Lock    | 1/4 - 20"         | 13.4 oz.  |
| Pro Pod 600    | 63"            | 21"           | 11 lbs.       | 4            | Flip Levers   | 1/4 - 20"         | 1.33 lbs. |
| Pro Pod 350    | 63"            | 20"           | 8 lbs.        | 4            | Flip Levers   | 1/4 - 20"         | 13.4 oz.  |



For Any Inquiries Regarding Your Order, Call Our Customer Service:  
 (800) 221-5743 • (212) 239-7765 • FAX: (800) 947-2215 • (212) 239-7549

## MONOPODS

### E-Z Pod

Often imitated, never improved. For years the E-Z Pod has been the choice of enthusiast around the world to shoot special events with much less bounce or shake. With its retracting video indexing pin, rubberized quick release camera platform and unique floating height adjustment, the E-Z Pod gives you easy, precise, push button, eye-level camera height control, as well as fast mounting of your camera.

- ◆ The top section is made with a handle that is thicker than a normal monopod making it easy and comfortable to grip.
- ◆ Within the handle is a spring loaded top section that allows you to easily make final height adjustments with just one hand.
- ◆ A folding foot brace keeps the bottom of the monopod secure in any surface.
- ◆ One of the buttons releases the spring so the height can be adjusted up or down about 5", the other button locks the spring into place once the perfect height has been reached.
- ◆ Quick release plate allows for fast mounting and removal of cameras.
- ◆ 5 legs section mean that this monopod folds down to a very compact 18".

**E-Z Pod (SLEZP).....49.95**

### E-Z Pod Jr.

Same leg locks and QR video plate as the E-Z Pod but without the spring loaded fine height adjustment feature. 5-section legs allow this monopod to fold down to just 20".

- ◆ Quick release platform is perfect for fast camera mounting and removal
- ◆ Panhead adjusts for desired tilt movement
- ◆ Five section, rigid tubular legs extend to 63" and folds down to 20".
- ◆ Single-action speed release locks

**E-Z Pod Jr. (SLEZPJ).....39.95**

### Slim Pod

The sturdy, ultra-thin and lightweight rigid aluminum Slim Pod has a built-in head and weighs just 10 ounces. 4-section single-action speed release leg locks make setting up easy, fast, and secure. This full-length monopod extends to 59.5".

- ◆ Four leg sections give you true eyelevel operation
- ◆ Adjustable panhead provides vertical tilt and horizontal panning action

**Slim Pod (SLSP).....24.95**

### Lighty Pod II

This all metal monopod features 5-section legs with section speed release leg locks, a supplied compact ball head for quick and smooth position changes and easy-to-operate flip-lock leg levers. When fully extended, it is over 63" tall.

- ◆ Grooved design prevents leg rotation while locking and unlocking
- ◆ Heavy-duty wrist strap ensures a secure grip when you are moving about

**Lighty Pod II (SLLP2).....49.95**

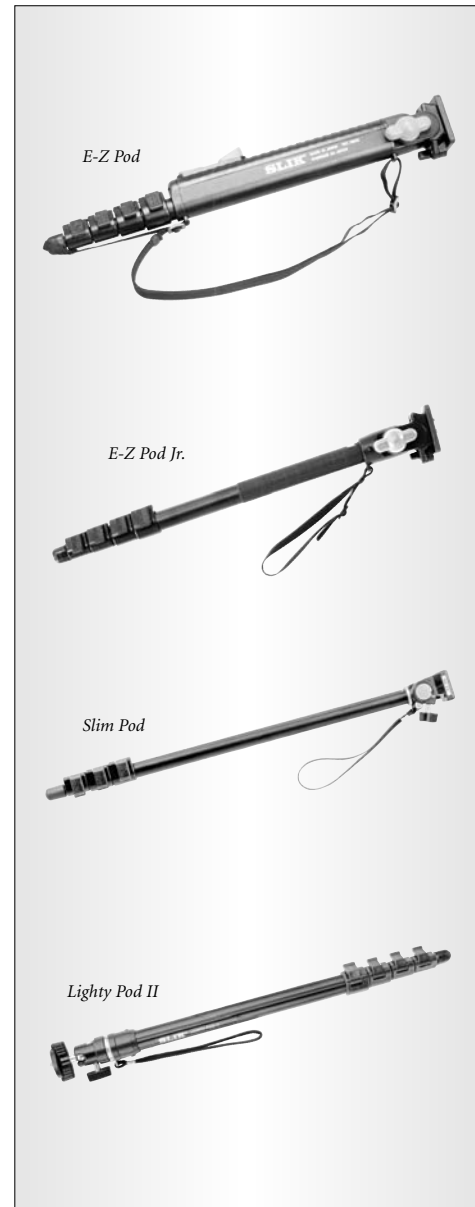

### MONOPOD SPECIFICATIONS

|               | Maximum Height | Folded Length | Load Capacity | Leg Sections | Leg Lock Type | Head Mount Thread | Weight   |
|---------------|----------------|---------------|---------------|--------------|---------------|-------------------|----------|
| E-Z Pod       | 62.7"          | 18.5"         | 8.5 lbs.      | 5            | Flip Levers   | 1/4 - 20"         | 1.5 lbs. |
| E-Z Pod Jr.   | 63"            | 20.3"         | 8.5 lbs.      | 5            | Flip Levers   | 1/4 - 20"         | 1 lb.    |
| Slim Pod      | 59.5"          | 20"           | 2.75 lbs.     | 4            | Flip Levers   | 1/4 - 20"         | 0.63 lb. |
| Lighty Pod II | 63.3"          | 20.6"         | 6.6 lbs.      | 5            | Flip Levers   | 1/4 - 20"         | 1 lb.    |

# SUNPAK

## COMPACT & MINI TRIPODS

TRIPODS

506

### Mini Series Tripods

The Mini-Plus, Mini-PRO Plus and Mini-PRO Plus/B tripods are ready to fill any small tripod need. The Mini-Plus, with its distinctive champagne finish, is the ultimate in compact yet full-feature design. Its 3-way head with built-in bubble level and retractable video indexing pin features a short panning knob to maintain its ultra compact design. The pan head is easily removed for use with other Sunpak accessories, such as the Sunpak Compact Ballhead.

#### Mini-Plus (SUMP)

Leg extensions include both twist locks for the middle leg section, and a quick-pull for the lower leg section, extending the working height to over 12", yet folding down to a mere 8.5" and weighing only 13.7 oz. The center column is secured with an oversized locking collar, while the lower end of the column has a suction cup mount to adhere to smooth surfaces. This is ideal for when using the tripod with longer focal lenses, to prevent camera tip-over. ....18.95

#### Mini-PRO Plus (SUMPP)

Identical to the Mini-Plus in features, the Mini-PRO Plus has an extendable panhandle that affords users more precise panning control. The Mini-PRO Plus has a maximum height of 12.2", yet folds to less than 8" and weighs only 14.9 oz .....21.95

#### Mini-PRO Plus/B (SUMPPBH)

The Mini-PRO Plus/B, in black anodized finish, features Sunpak's Compact Ballhead. With its large locking knob and full 90° tilt for vertical format, the Mini-PRO Plus/B – as with all Mini-Series tripods – has a load capacity exceeding 2 lbs. 3 oz .....29.95



A leading manufacturer, Sunpak has developed a reputation as an innovator devoted to the highest level of product quality. Sunpak tripods are amazingly light, yet offer remarkable strength and stability, and their uniquely engineered designs and wide selection allow you to choose just the right support to hold your camera steady at any angle, indoors or out, on virtually any terrain. Plus, all tripods, monopods and ball heads carry Sunpak's exclusive Lifetime Warranty.



### VersiPod Tabletop Tripod

The Sunpak VersiPod may well be the most versatile miniature tripod ever invented. Targeted at today's fast-paced, instant-communication lifestyle, the VersiPod lets you take sharper photos with almost any ultra-compact digital or film camera, and even pen-sized cameras. Thanks to its fully adjustable, lockable ball head and ingenious, padded, caliper-type, swing-arm camera cradle that's adjustable from 3/16 to 2 1/4" wide, the VersiPod provides a secure platform for practically any pocketable imaging device on the planet. Telescopic-rubber tipped legs extend to a 10" height—perfect for shooting at parties, in restaurants, offices, or your living room—anywhere there's a flat surface. When you're through, just unscrew the camera cradle, collapse the legs and stow the VersiPod in its handsome, included carrying pouch and slide it into a jacket pocket or pocketbook. It's so cool looking and useful, you'll never want to be without it!

VersiPod Silver/Clear Tripod (SUVPS) ...11.95

VersiPod Blue Tripod (SUVPBL) .....11.95

VersiPod Red Tripod (SUVPR).....11.95



For Any Inquiries Regarding Your Order, Call Our Customer Service:  
(800) 221-5743 • (212) 239-7765 • FAX: (800) 947-2215 • (212) 239-7549

# SUNPAK

## COMPACT & MINI TRIPODS

**2002 Pocket Tripod with Two Leg Sections (SUP2)** .....7.95

**Tabletop Tripod with Flexible Legs (SUFL):** A tabletop tripod with flexible legs to support a compact digital or 35mm camera .....3.95

**Mini Flat Tripod (SUMF):** This tripod folds totally flat and is only approximately 5" long when folded. It will even fit into a shirtpocket. Rubber tipped legs add sturdiness to this mini tripod. Designed to support a compact 35mm, digital or DV camera .....6.95

**2003 Pocket Tripod with Three Leg Sections (SUP3):** The 2003 is a mini pocket tripod, ideal for use with a compact digital or 35mm camera. Three leg sections extends the tripod to 9.75". Can go down very low, minimum height is only 2.75". Folds to 7" .....9.95

**1001D Tabletop Tripod with Mini Ball Head (SU1001D):** Mini tabletop tripod ideal for use with a compact digital or 35mm camera. Three leg sections extends the tripod to 11.5". Minimum height is 6.75". Folds to 7.25". Includes a pouch case .....14.95

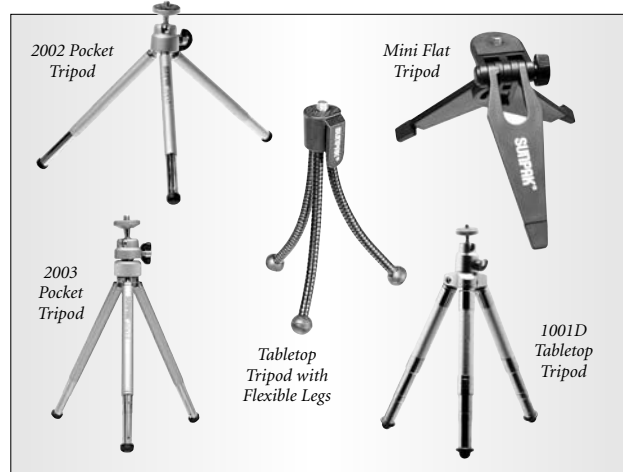

### Compact SXL (SUSXL)

Like its name implies, the Compact SXL tripod is sure to please backpackers and travelers alike, easily fitting into a backpack or packed luggage case size. At only 14.6" when folded, and weighing less than 1.6 lbs., the tripod quickly extends to a comfortable working height of 43.5", aided by its four-section legs, and fast lift and lock center column with ribbed locking collar. Folding metal leg braces add stability, while the quick lever leg locks permit quick setups and height adjustments. Non-skid rubber leg tips provide maximum traction outdoors and protection to surfaces indoors. The two-way head, rated for equipment up to 3 lbs. 6 oz., has separate locking pan and tilt controls to provide easy adjustment, for fast action photos. Comes in a professional black anodized finish .....21.95

### Compact DXL (SUCDXL)

Designed for use with digital or film cameras, the Compact DXL weighs in at a feather-light 24.9 oz, while supporting loads of up to 3.3 lbs. This sturdy, rugged tripod adjusts to a maximum height of 43.5", while folding down to a compact 14.6". Its convenient center column tension adjustment collar helps reduce sudden movement when adjusting the tripod's height, making it ideal for use with camcorders. Each leg of the Compact DXL has three separate leg extensions, and each segment may be withdrawn or extended as needed, so positioning your tripod on uneven terrain is easy. Center leg braces provide maximum stability, while quick release leg locks and easy to use handles, knobs and levers make operation a breeze .....22.95

## 7001D Camera Tripod

With a comfortable full working height of 58.3", and load capacity of up to 4.4 lbs, the 7001D is an ideal choice for working with digital as well as conventional film cameras. The 7001D is equipped with a rack and pinion geared center column for precise height adjustments, while its tension adjustment collar minimizes any sudden movement when adjusting the tripod's height.

- ◆ For precision control, the 7001D's Universal Pan-head is equipped with both tilt and pan reference marks, making it easy for you to quickly and accurately return to any previous settings.
- ◆ Separate leg extensions on each leg enable you to set your equipment at a comfortable height on even and uneven terrain, while retractable leg spikes and metal center leg braces provide maximum stability and added strength.
- ◆ A quick release platform with built-in bubble level enables precise leveling

**7001D Camera Tripod (SU7001D)** .....29.95



# SUNPAK

## UT SERIES

TRIPODS

508

Offering unique styling and a distinctive champagne finish, all UT series tripods include 3-way pan heads with reference scales, large locking panhandles, quick release platforms, metal center leg braces, tension/load adjustment, quick-release leg locks and heavy-duty rubber leg tips, some with leg spikes, for fast setup and rock solid stability. Plus, every UT series tripod comes with a free 2nd quick-release mounting plate for a second camera/camcorder.

### 2001UT (SU2001UT)

Lightweight and compact, the 2001UT is an excellent travel tripod. Designed for use with compact cameras, it offers a 3-way pan head with a tilt reference scale and separate locking controls, and a quick-release mounting plate with retractable video indexing pin. With a folded length of only 19.7", it extends to 49", yet weighs a mere 37 ounces with its solid 22mm leg diameter. Added stability from metal center leg braces with separate locking knob assures rigid support, while heavy-duty rubber leg tips keep the 2001UT in place at all times. Quick-release leg locks make setup fast and easy, even while wearing gloves. The gearless "lift-n-lock" center column, with its large, ribbed locking collar, permits fast height adjustments, while a separate tension/load control can be set for cameras weighing as much as 4 lbs. 6 oz.....**18.95**

### 6601UT (SU6601UT)

With a comfortable full working height of 58.3", and a minimum operating height of 20.3", the 6601UT features a quick-release platform with an integral bubble level, and a second circular bubble level at the critical tripod collar for precise camera/tripod alignment. Also standard with the 6601UT is a precision-g geared center column, accessory 1/4 x 20 mounting stud on the center column, and retractable spiked feet. The 6601UT provides all this in addition to the full set of features found on the 2001UT .....**27.95**

### 8001UT (SU8001UT)

Extending to over 60", the 8001UT is able to support equipment weighing as much as 6 lbs. 9 oz. The 8001UT offers a rock-solid 25mm leg diameter, and provides all the features found on the 6601UT, while weighing only a mere 10 oz. more.....**34.95**

### 9001UT (SU9001UT)

Extending to over 60", the 9001 UT is able to support equipment weighing as much as 6 lbs. 6 oz. The 9001UT offers a rock-solid 1-inch leg diameter, and provides all the features found on the Sunpak 6601 UT , while weighing only a mere 11 oz. more .....**39.95**



### UT SERIES SPECIFICATIONS

|                    | 2001UT    | 6601UT   | 8001UT                      | 9001UT                      |
|--------------------|-----------|----------|-----------------------------|-----------------------------|
| Maximum Height     | 48.9"     | 58.9"    | 59"                         | 60.2"                       |
| Minimum Height     | 17.9"     | 21.3"    | 21.5"                       | 22"                         |
| Folded Length      | 18.8"     | 22.4"    | 23.2"                       | 24"                         |
| Load Capacity      | 4.4 lbs.  | 4.4 lbs. | 6.6 lbs.                    | 6.6 lbs                     |
| Leg Sections       | 3         | 3        | 3                           | 3                           |
| Center Column Type | Rapid     | Geared   | Geared with tension control | Geared with tension control |
| Weight             | 2.31 lbs. | 2.8 lbs. | 3.3 lbs.                    | 3.3 lbs.                    |



EQUIPMENT LEASING AVAILABLE

# SUNPAK

## 3300 PRO

### 3300 PRO

Setting the standard in both performance and style, the 3300 Pro is manufactured from Tritanium (an ultra-lightweight alloy of titanium, magnesium and aluminum), and delivers incredible strength-to-weight performance. Able to support equipment weighing up to 11 lbs., the 3300 PRO weighs a mere 3 lbs., 4 oz., while its dual groove leg design adds additional strength without any extra weight.

- ◆ It opens to a maximum height of 63", has three leg sections, with integral quick-release lock levers, and features multi-angle leg adjustments for use on uneven terrain or for extreme low angle photography.
- ◆ With "grounder" capability, the 3300 PRO can operate at a minimum height of less than 23", without the need for a short center column.
- ◆ Folds to a compact 23.9". Other features include a 3-way pan head with quick-release mounting plate, and a reversible center column, with locking height controls and tension load adjustment.

**3300 Pro Tripod with 3-Way Pan/Tilt Head (SU3300P) .....69.95**

**3300 PRO-B (SU3300PB):** An enhanced version of the 3300 Pro, the 3300 PRO-B extends from a minimum working height of 11" to a maximum height of 62.9", and folds down to 23.2". It weighs only 2.7 lbs, supports 11 lbs. and features 3-position angle adjustment latches for maximum stability.....79.95



TRIPODS

509

### 3300 PRO and Fieldmaster Specifications

|                    | 3300 PRO                     | 3300 PRO-B | FieldMaster | FieldMaster LE |
|--------------------|------------------------------|------------|-------------|----------------|
| Maximum Height     | 63"                          | 63"        | 57.8"       | 57.8"          |
| Minimum Height     | 18.5"                        | 18.5"      | 11"         | 11"            |
| Folded Length      | 23.6"                        | 23.2"      | 21"         | 21"            |
| Load Capacity      | 11 lbs.                      | 11 lbs.    | 4.4 lbs.    | 4.4 lbs        |
| Leg Sections       | 3                            | 3          | 3           | 3              |
| Center Column Type | Rapid (with tension control) | Rapid      | Rapid       | Rapid          |
| Weight             | 3.31 lbs.                    | 3.31 lbs.  | 2.2 lbs.    | 2.2 lbs.       |

### FieldMaster and FieldMaster LE

Sturdy, rugged and reliable FieldMaster (Black) and FieldMaster LE (Green) tripods extend to a maximum working height of 58", and a minimum operating height of 11.0". These high-quality tripods feature a quick-release platform with a built-in bubble level for precise leveling, and can support up to 8.8 lbs with the supplied panhead with quick release, and 4.4 lbs with the supplied ballhead (yes they come with two heads).

- Individual leg angle adjustments, separate leg extensions with quick twist leg locks on each tripod leg and retractable leg spikes enable you to set up your equipment at a comfortable height on even or uneven terrain, with the utmost stability.
- They are equipped with a two-section "split" center column for ultra-low angle use
- A removable metal accessory hanger at the bottom of the center column permits you to suspend a stabilizing weight, helping to reduce any unnecessary camera/tripod movement.

**FieldMaster (SUFMP) .....49.95      FieldMaster LE (SUFMLE) .....49.95**



**ORDER & INFO. (212) 502-6340 • FAX: (212) 239-7770 (800) 947-7008  
1-800-290-6750 • www.bhphotovideo.com**



# SUNPAK

## ULTRAPRO SERIES

TRIPODS

510

### UltraPro 757 / 777 Tripods

Pro-caliber tripods, the UltraPro Series combine innovative engineering, rugged construction, a full complement of advanced features, and outstanding value. Based on a unique asymmetrical leg design providing extra torsional rigidity and added stability at any height, Sunpak UltraPro tripods are further enhanced with oversized, ergonomically designed flip leg-locks, lockable U-section metal leg braces, and graduated leg sections plus fully calibrated tilt controls for quick and easy setup in the field or studio.

- ◆ Smooth-action 3-way fluid-effect head with separate friction controls for pan and tilt
- ◆ Locking vertical-angle adjustment, plus adjustable-length handle for video applications.
- ◆ Geared center column with easy-grip locking knob and separate friction adjustment.
- ◆ Heavy-duty articulated rubber leg tips with retractable spikes.
- ◆ Removable head and second 1/4x20 mount on bottom of center column for low-angle shooting.
- ◆ Free second quick-release plate for maximum convenience when using two cameras. And both include a generous limited lifetime warranty.



**UltraPro 757 (SUU777):** Silver color. The UltraPro 757 has separate bubble levels on the top yoke and on the smooth-action, 3-way fluid effect pan/tilt head.....**79.95**

**UltraPro 757B (SUUP757B):** Same as above in black color .....**79.95**

**UltraPro 777 (SUUP777):** Silver color. It has a single bubble level on the pan/tilt head, but offers ultra-wide leg-spread capability for extreme low-angle “grounder” shots.....**89.95**

**UltraPro 777B (SUUP777B):** Same as above in black color .....**89.95**

#### ULTRAPRO SPECIFICATIONS

|                    | 757 / 757B | 777 / 777B |
|--------------------|------------|------------|
| Maximum Height     | 74.8"      | 71.7"      |
| Minimum Height     | 28"        | 25"        |
| Folded Length      | 29.4"      | 28"        |
| Load Capacity      | 11 lbs.    | 11 lbs.    |
| Leg Sections       | 3          | 3          |
| Center Column Type | Rapid      | Geared     |
| Weight             | 6.2 lbs.   | 6.6 lbs.   |

#### BALL HEAD SPECIFICATIONS

|                          | Compact          | Medium                  |
|--------------------------|------------------|-------------------------|
| Maximum Camera Supported | Medium-sized SLR | SLR with telephoto lens |
| Load Capacity            | 4.2 lb.          | 6.5 lb.                 |
| Height                   | 3.2"             | 3.2"                    |
| Quick Release            | No               | No                      |
| Spirit Level             | No               | No                      |
| Tripod Mount Thread      | 1/4"-20          | 1/4"-20                 |
| Weight                   | 0.29 lbs.        | 8.1 oz.                 |

### Compact and Medium Ball Heads

Sunpak's beautifully-finished Compact and Medium Ball Head are the perfect complement to compact digital and film cameras. Featuring a heavy-duty nickel-plated ball-joint for years of dependable use, the rugged ball-and-socket design of these heads allow for quick camera positioning, both horizontally and vertically. For added ease in securing and positioning a camera, knurled camera mount and locking knobs provide positive textured holding surfaces, while an anti-scratch plate keeps camera bottoms from being damaged. Weighing only 4.8 oz. and 8 oz. respectively, these “take anywhere” heads mount to tripods with a 1/4-20 stud.

**Compact Ball Head (SUBHC):** For use with compact cameras. Supports 4.2 lbs .....**19.95**

**Medium Ball Head (SUBHM):** For use with most 35mm cameras. Supports 6.5 lbs.....**24.95**





## MONOPODS

### EZEE Pod

Distinctively styled with a professional black finish, the full-featured EZEE Pod is equipped with Sunpak's interchangeable UT Series 3-way pan head, which features a quick-release platform with built-in bubble level. For added versatility, the 3-way pan head can easily be removed, permitting EZEE Pod to accept other heads, like Sunpak's Compact Ballhead.



- ◆ Weighs only 27.8 oz. but can support equipment weighing up to 3.3 lbs.
- ◆ The four-section grooved tubular leg design extends to 62", folds down to 22.8".
- ◆ Fast, "no snag" twist lock collars and speedy, one-hand "floating power assist" height adjustment speeds camera positioning for easy setups and rock-solid stability.
- ◆ A heavy-duty swivel rubber tip provides sure footing and a convenient carry strap is included for easy transport.
- ◆ Includes a FREE second quick-release mounting plate for a second camera

**EZEE Pod (SUEZEE) .....39.95**

### Compact Monopod

The Compact Monopod provides sharp images and steady viewing with cameras, binoculars and scopes. Super-compact and lightweight, it folds to 16½" and weighs only 14.4 oz. easily fitting most camera bags and packs. Easier and quicker to set up than a



tripod, it's multiple anodized metal leg sections extend to 60" for

comfortable eye-level shooting, and it has a locking ball head for fast adjustments

- ◆ Comfortable neoprene handgrip and leg-lock rings, handy neckstrap, and an ingenious belt/waist clip that fits into the rubberized leg tip so you can use the monopod as a chest pod for fast-action photography and maximum maneuverability in tight places

**Compact Monopod (SUMC) .....39.95**

## STUDIOBALL

### Professional Ballheads

*Manufactured in Switzerland, by J.P. Graf, Studioball is a high-precision engineered ballhead suited for both studio and outdoor photography. Made from aircraft-strength aluminum, Studioball comes in two sizes, standard, and mini, and are available in either Quick Release or reversible 1/4" and 3/8" stud configurations. Features exclusive to*



*Studioball make it an outstanding choice for supporting just about any camera system, from 35mm up to larger 8 x 10 field cameras. Shooters who use long lenses will especially benefit from their many features.*

- ◆ The exclusive ball bearing swiveling pan mechanism (SB-QR and SB-14) provides absolutely smooth and vibration-free camera rotation. Long life and reliable function is guaranteed even under the most severe conditions.
- ◆ Dual function friction knob, which (A) adjusts relative tension on the ball, and (B) safely locks the ball head, preventing tipping over of the camera if the main locking knob is loosened inadvertently.
- ◆ Large size main locking knob, which holds the camera in any position, including verticals, providing rock steady support for even the heaviest camera/Tele-Lens combinations.
- ◆ Heavy duty 6mm body casing
- ◆ Posi-Lock quick release mechanism (SB-QR) provides that extra bit of "insurance" that many photographers have so often wished that they had. Camera plates, which can be inserted from either side of the quick release mechanism are held in place not only by tightening the quick release locking knob, but by the addition of a red safety lock device which holds the camera in place, even in case of unintentional loosening of the locking knob.
- ◆ The MiniBall version is perfect for backpacking or any time weight is a problem — it weighs only 1 lb. 3 ounces.

|                        | SB-QR    | SB-14   | MI-QR     | MI-14     |
|------------------------|----------|---------|-----------|-----------|
| <b>Load Capacity</b>   | 45 lbs.  | 45 lbs. | 13 lbs.   | 13 lbs.   |
| <b>Tripod Socket</b>   | 3/8"-16  | 3/8"-16 | 3/8"-16   | 3/8"-16   |
| <b>Pan, horizontal</b> | 360°     | 360°    | 360°      | 360°      |
| <b>Tilt, vertical</b>  | 95°      | 95°     | 95°       | 95°       |
| <b>Weight</b>          | 3.7 lbs. | 3 lbs.  | 1.23 lbs. | 0.91 lbs. |
| <b>Height</b>          | 5.5"     | 5.4"    | 4"        | 3.9"      |
| <b>Base Diameter</b>   | 3.5"     | 3.5"    | 2.4"      | 2.4"      |

#### SB-QR Studioball Ballhead (STSBQR)

With independent panning lock and quick release.....**399.95**

#### Miniball Studioball (STMBQR)

With quick release .....**239.95**

#### SB-14 Studioball (STSB.25):

With independent panning lock and reversible 1/4" and 3/8" screw .....**369.95**

#### Studioball Miniball (STMB)

With reversible 1/4" and 3/8" screw..**199.95**

# TILTALL & OTHERS

## PRO TRIPOD WITH 3-WAY PAN-HEAD

TRIPODS

512

Includes what is probably the most unique panhead ever designed. The multi-position panhead tilts 90° to the left, 45° to the right, 90° forward and 45° backward. The center post rotates a full 360°. The tripod is complemented with all metal locking knobs, pan handles and all terrain legs featuring both rubber and spiked feet. You also get the bonus of one leg that screws off and becomes a full length monopod. Available in black, silver and gold. 60" maximum height, 70" with center post extended, folds to 30", and weighs 6 lbs.

**Tiltall Black (TIST01B) .....109.95    Tiltall Silver (TIST01S) .....99.95    Tiltall Gold (TIST01G).....119.95**

### Tiltall JR

Back by popular demand, the Tiltall JR offers the exact same features and construction as the full size Tiltall ST-01 in a compact design. Available in black or silver, the Tiltall JR tripod has a maximum height of 43.2" (53.2" with center post extended), folds to 23.8", and weighs 3.6 lbs.

**Tiltall JR Silver (TIST06JRS) .....89.95**

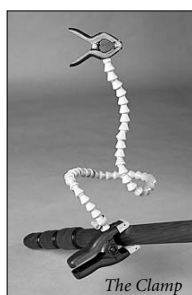

The Clamp

## McClamp "The Clamp" & "The Stick"

The Clamp and The Stick eliminate wind effect for improved sharpness of photographs. The Clamp clamps to a tripod leg while The Stick sticks into the ground, allowing them to hold such items as gray cards and 12" reflectors. They improve compositions by providing more control of your subject and background. Explore new creative angles by adjusting their 26" flexible arm while the clamp holds your small subject in place. The holding clamp has two surfaces - firm plastic outside jaws for a firm grip, and soft inner neoprene jaws to hold delicate subjects. They store flat in a camera bag and include a nylon carrying bag.

**The Clamp (MCC).....39.95    The Stick (MCS) .....39.95**

## THE POD

A versatile beanbag with a 1/4"-20 camera screw protrusion, The Pod acts as an impromptu camera-holding assist for a myriad of unusual scenarios. Sealed with a strong strip of velcro and filled with malleable plastic pellets, it finds a way to contort itself to a supportive shape. Stitched with tough nylon and with removeable insides for lightweight travel when needed.

- ◆ Water-resistant nylon construction with tough stitching
- ◆ Can be used in places where tripods are normally prohibited, such as museums and monuments
- ◆ Non-marking non-slip base
- ◆ 5 x 2" (WxH), it weighs 16 oz.

**The Pod:** Available in yellow (POPY) and red (POPR).....16.95

## ULTRAPRODUCTS

### UltraPod I/II Miniature Camera Supports

The UltraPod I is a small, lightweight (2oz.) portable camera tripod with sturdy fold out legs, a unique ball and socket camera mount assembly (with positive locking latches), and a strong Velcro strap for securing to tree limbs, railings, pack frames, or any other solid object. Folds to a compact 4". A larger (4oz.) version of the above, the UltraPod II is designed to support larger SLR cameras. Folds to 7.5" to fit in a pocket or camera bag.

**UltraPod I Black (ULUP1B) .....14.95    UltraPod I Blue (ULUP1BL) .....14.95**  
**UltraPod I Red (ULUP1R).....14.95    UltraPod I Yellow (ULUP1Y).....14.95**  
**UltraPod II (ULUP2B) .....18.95**

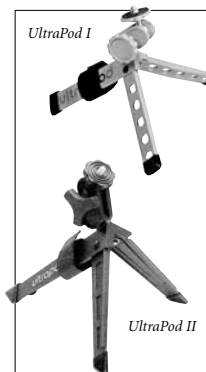

### UltraMount (ULUM)

A larger version of the ball and socket head on the UltraPod II. Same locking features for a secure setting. Has a 1/4-20 socket on the bottom for attaching to your own stand or tripod .....9.95

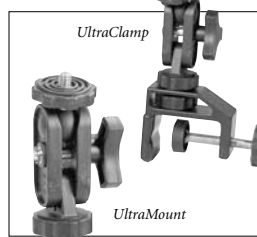

### UltraClamp (ULUC)

#### Universal Clamp Assembly

A strong, heat treated aluminum clamp, designed to attach to a rolled down car window, table top, bike handle bar — up to 1 1/2" tubes and pipes. Utilizes UltraMount ball and socket head for mounting digital cameras.....21.95



For Any Inquiries Regarding Your Order, Call Our Customer Service:  
 (800) 221-5743 • (212) 239-7765 • FAX: (800) 947-2215 • (212) 239-7549

# VELBON

## MINI TRIPODS

Mini tripods offer a variety of functions and features designed to cover most photo situations.

### **DF-MINI Dual Function Mini Tripod (VEDFM)**

All-black finish, deluxe mini "Dual-Function" grounder photo/video tripod with unique 3-way quick release panhead.....**34.95**

### **DF-10ML Deluxe Dual Function Mini Tripod (VEDF10ML)**

The DF-10ML is an all-black finish, deluxe dual-function tripod that features 3-way pan head with quick-release, lift center-column, 3-section extruded aluminum legs with radial braces, quick side-lever locks and rubber tipped feet.....**27.95**



TRIPODS

513

### **VGB-37**

The lightweight VGB-37 is a standard-size deluxe photo tripod that features all-die cast metal construction and extruded aluminum leg sections with quick lever leg locks, steel ground spikes with retractable round rubber feet and a 3-way diecast aluminum panhead with quick-release.



- ◆ Detachable 3-way panhead can be mounted to the bottom of the center column
- ◆ Bubble level for more precise tripod leveling
- ◆ Metal geared center column for precise camera positioning
- ◆ 3-section 23.5mm extruded aluminum legs with quick lever locks for fast, easy setup
- ◆ Radial leg braces and arm guide lock for extra stability

**VGB-37 Tripod (VEVGB37) .....79.95**

### **DF Series Tripods**

The all-black finish DF series are dual function tripods designed for use as both a photo and video tripod. The panheads feature a sure-grip pan/tilt control handle positioned on the left side for easy access to main camera controls. The tripods feature 3-section tubular aluminum legs with radial leg brace for extra stability and convenient tripod setup. Quick side-lever leg locks offer easy leg adjustments.



DF-30

**DF-30 Lightweight Tripod (VEDF30):**  
20mm wide leg and rubber tipped feet. Lift center column for quick and easy vertical camera positioning. 2-way panhead with a retractable camcorder alignment pin .....**27.95**

**DF-40 Deluxe Lightweight Tripod (VEDF40):**  
Steps up with a geared center column with preset friction control system, bubble level and QB-4LC 3-way quick release panhead for smooth pan and tilt .....**29.95**

**DF-50 Deluxe Lightweight Tripod (VEDF50):**  
With QB-4W 3-way quick-release fluid panhead. Same as the DF-40 except it has 23mm wide legs and steel ground spikes with adjustable round rubber tips...**44.95**

**DF-60 Deluxe Heavy-Duty Tripod (VEDF60):**  
With QB-5W 3-way fluid panhead and quick-release platform. Same as the DF-40 except it has 27mm wide legs and steel ground spikes with adjustable round rubber tips.....**54.95**

### **VGB-37 and DF SERIES SPECIFICATIONS**

|                    | VGB-37    | DF-30    | DF-40    | DF-50    | DF-60   |
|--------------------|-----------|----------|----------|----------|---------|
| Maximum Height     | 66"       | 57"      | 57"      | 59.5"    | 63.5"   |
| Minimum Height     | 23"       | 20.5"    | 20.5"    | 21.5"    | 23"     |
| Folded Length      | 24.2"     | 20.8"    | 21"      | 22.8"    | 23.8"   |
| Load Capacity      | —         | 5 lbs.   | 10 lbs.  | 12 lbs.  | 15 lbs. |
| Leg Sections       | 3         | 3        | 3        | 3        | 3       |
| Center Column Type | Geared    | Sliding  | Geared   | Geared   | Geared  |
| Weight             | 4.29 lbs. | 2.4 lbs. | 2.6 lbs. | 3.2 lbs. | 4 lbs.  |

**ORDER & INFO. (212) 502-6340 • FAX: (212) 239-7770 (800) 947-7008  
1-800-290-6750 • www.bhphotovideo.com**



# VELBON

## CX SERIES

The titanium bronze and black CX Series are deluxe standard - size dual -function tripods that feature a unique 3-way panhead that is ideally suited for use with all compact digital and 35mm SLR cameras. The panheads are equipped with a left-positioned sure-grip pan/tilt control handle that allows easy access to the main camera controls as well as better flash position when the camera is in the vertical orientation.

### CX-444 Deluxe Photo/Video Tripod

- ◆ Unique panhead design features left side control handle with right side camera platform tilt
- ◆ The 3-way panhead(PH-249Q) incorporates a large 2-position quick-release camera platform (QB-4W) with retractable camcorder alignment pin.
- ◆ Sure-grip pan/tilt control handle also serves as the locking mechanism for the tilt movement on the panhead.
- ◆ Side tilting and panning lock knobs
- ◆ Geared center column with preset friction control system for quick vertical camera positioning
- ◆ 4-section 20mm tubular aluminum legs with radial leg braces for maximum stability and convenient tripod setup
- ◆ Quick side-lever locks for easy leg adjustments

CX-444 Deluxe (VECX444) .....38.95

### CX-470 Deluxe Tripod (step-up features)

- ◆ 3-way pan head (PH-349Q) features a sure-grip pan/tilt control handle that is positioned on the left side for more positive panhead control. This allows the right hand unobstructed access to control camera functions.
- ◆ Right-tilting camera platform allows vertical and horizontal composition. Additionally, cameras with heavier lenses will sit more securely to the platform in the vertical position.
- ◆ Non-slip rubber tipped feet
- ◆ 3-section 20mm tubular aluminum legs with radial leg braces for maximum stability and convenient tripod setup.

CX-470 Deluxe (VECX470) .....29.95

### CX-570 Deluxe Tripod (step-up features)

- ◆ Leveling bubble is mounted on the tripod body for more precise leveling.

CX-570 Deluxe (VECX570) .....39.95



### CX-690 Deluxe Heavy-Duty Photo/Video Tripod

- ◆ Deluxe, heavy-duty dual-function tripod ideally suited for use with 35mm SLR, point and shoot, and compact cameras, plus compact and full-size camcorders
- ◆ Thicker 3-section 27mm tubular aluminum legs with radial braces for maximum stability and convenient tripod setup
- ◆ Large 3-way fluid pan head (PH-259Q) features a sure-grip pan/tilt control handle that is positioned on the left side, allowing the right hand unobstructed access to control camera functions.
- ◆ Right-tilting quick-release platform allows 35mm cameras vertical as well as horizontal composition
- ◆ Leveling bubble is mounted on the tripod body for more precise tripod leveling
- ◆ Geared center column with preset friction control for quick and easy vertical camera positioning.
- ◆ This hefty tripod weighs only 3.9 pounds, yet can be extended to 63" and folds down to 24.3".

CX-690 Deluxe (VECX690) .....59.95

### CX SERIES SPECIFICATIONS

|                    | CX-444        | CX-470   | CX-570   | CX-690   |
|--------------------|---------------|----------|----------|----------|
| Maximum Height     | 57"           | 57"      | 59"      | 63"      |
| Minimum Height     | 20"           | 20"      | 21"      | 23"      |
| Folded Length      | 21.3"         | 21.6"    | 22.8"    | 24.3"    |
| Load Capacity      | 5 lbs.        | 10 lbs.  | 12 lbs.  | 15 lbs   |
| Leg Sections       | 3             | 3        | 3        | 3        |
| Center Column Type | Rapid Sliding | Geared   | Geared   | Geared   |
| Weight             | 2.4 lbs.      | 2.4 lbs. | 3.2 lbs. | 3.9 lbs. |



# VELBON

## CHASER & CHASER E SERIES

The sturdy, medium-weight Chaser and Chaser E tripods offer reliability and durability for the photographer who requires more of his/her tripod. The leg assemblies are constructed of die-cast components and extruded aluminum tubular legs with quick side-lever leg locks for quick and easy set-up. The unique design of the optional 3-way panhead allows for better support of longer lenses. The camera mounting threads are designed to tighten against the camera platform. Heads are mounted on lift center columns (Chaser E series) or friction adjustable geared center columns (Chaser series).



**Chaser EFL-3 (VECEFL3A):** The EFL-3 features 3-section 26mm extruded tubular aluminum legs, slotted slide-lever locks for quick and easy leg adjustments and rubber-tipped feet for no-slip set ups .....**69.95**

**Chaser EFL-4 (A) (VECEFL4A):** Same as above EFL-3 plus 2-section lift center column and 3-position leg spread for low-angle camera shooting, and 4-section 26mm extruded aluminum tubular legs .....**79.95**

**Super Chaser (A) (VESC):** The Super Chaser (A) features 3-section 26mm extruded tubular aluminum legs and an extra-long geared center-column extension. An optional panhead can be attached beneath the center column for low-angle shots .....**54.95**

### CHASER SERIES SPECIFICATIONS

|                    | EFL-3    | EFL-4 (A) | Super Chaser (A) |
|--------------------|----------|-----------|------------------|
| Maximum Height     | 65.9"    | 60.8"     | 60.5"            |
| Minimum Height     | 10.9"    | 10"       | 22"              |
| Folded Length      | 25.8"    | 21"       | 23.5"            |
| Load Capacity      | 12 lbs.  | 11 lbs.   | 12 lbs.          |
| Leg Sections       | 3        | 4         | 3                |
| Center Column Type | Sliding  | Sliding   | Geared           |
| Weight             | 4.4 lbs. | 5 lbs.    | 3.5 lbs.         |

TRIPODS  
515

### OPTIONAL PANHEADS & BALL SOCKET HEADS FOR CHASER TRIPODS



**PH-157 3-Way Panhead (VEPH157):** All die-cast metal panhead with left side mounted pan/tilt control handle and right tilting camera mounting platform .....**27.95**

**PH-157Q 3-Way Panhead with Quick-Release Camera Platform (VEPH157Q):** Same features as the PH-157 Panhead, but with a QB-157 quick-release camera platform .....**37.95**

**PH-243 Mini-Compact Ball Socket Head (VEPH243):** Mini-compact ball socket head features metal construction with single lever operation. Supports up to 3 lbs .....**24.95**

**PH-253 Compact Magnesium Ballhead (VEPH253):** Made of diecast magnesium for light weight and strength. Single lever operation with panning. Base diameter is 1.7". Support 6.6 lbs .....**59.95**

**PH-343 Medium Ballhead (VEPH343):** Made of diecast magnesium for light weight and strength, and features single lever operation, with a panning base. Supports up to 2.5 lbs .....**29.95**

**PH-353 Large Ballhead (VEPH353):** Made of diecast magnesium for light weight and strength. Single lever operation with panning base. Features a 2" diameter camera platform. It supports up to 6.6 lbs .....**39.95**

# VELBON

## MAXi SERIES

TRIPODS

516

Utilizing an innovative Trunnion Shaft system that makes them extremely lightweight and compact, the MAXi series are the ideal traveling tripods. The trunnion shaft design of the MAXi's legs allows a ratio of working height to collapsed length which was previously impossible. Sufficiently sturdy and supremely compact, it is an ideal travel tripod for small cameras. They also feature all die-cast construction, lift center column for quick and easy camera positioning, four-section leg design with rubberized quick release leg locks, and convertible leg tips (rubber foot pads can be retracted to reveal spikes for soft ground). Each leg can be extended or moved outward separately.

- ◆ The MAXi 343E and 347E feature a lift center column for quick and easy camera positioning. The MAXi 343E offers the all metal die-cast PH-243 ball socket head, while the 347E features a patented panhead, the PH237Q. They all include a tripod case.
- ◆ The MAXi 347E and 347GB are equipped with the specially designed PH-237Q panhead. Where most standard panheads add length when a tripod is collapsed, the PH-237Q panhead features a one-of-a-kind flat design that allows for minimum compactness when the tripod is closed.
- ◆ The MAXi 347GB with a geared center column offers more precise control of the upward and downward movement of the center column. It also comes with sturdy leg braces for greater stability.

### MAXi SERIES SPECIFICATIONS

|                  | Extended Height | Folded Length | Weight  | Price |
|------------------|-----------------|---------------|---------|-------|
| 343E (VEM343E)   | 62.4"           | 17.5"         | 1.9 lbs | 69.95 |
| 347E (VEM347E)   | 63"             | 17.3"         | 2.2 lbs | 89.95 |
| 347GB (VEM347GB) | 63.4"           | 16.8"         | 2.6 lbs | 89.95 |



## ULTRA-MAXi-S

Using the same innovative Trunnion Shaft system as the MAXi Series, the Ultra-MAXi-S is extremely lightweight and compact and features all die-cast metal construction. The Direct Contact Pipe System of this five section tripod allows you to extend and lock it's legs at any point with a unique "Quick Twist n' Lock" mechanism in the leg pipe. This allows it to extend to more than 4.4 times its folded length. Each leg section locks by twisting clockwise and unlocks when twisting the leg pipe counterclockwise. This new system also speeds up the set-up time. A great tripod for light gear when you're travelling abroad. The Ultra-MAXi-S includes a tripod case.

Ultra-MAXi-S (VEUMS)

Includes an all metal die-cast PH-243 ball socket head.....99.95

### ULTRA MAXi-S SPECIFICATIONS

|              | Extended Height | Folded Length | Weight  |
|--------------|-----------------|---------------|---------|
| Ultra Maxi-S | 50"             | 17.3"         | 1.7 lbs |



EQUIPMENT LEASING AVAILABLE

# VELBON

## ULTRA-MAXiF & ULTRA-LUXiF

### Travel Tripods

The ULTRA Series tripods (MAXiF, MAXiSF, LUXiF and LUXiSF) have a patented Direct Contact Pipe System which is a unique cross-section of the leg tubes that enables you to quickly lock and unlock the leg sections simply by a half-turn twist. This allows the user to extend and lock the tripod's legs at any point, without traditional flip locks, by using a unique "Quick Twist n' Lock" mechanism in the leg pipe. They also feature a patented Trunnion Shaft System where the main leg bolts are now positioned above the shafts. This allows the telescopic leg tubes to slide further into each other and utilize the area previously occupied by the bolt. This makes the tripod more compact when closed and taller when extended. They each have five leg sections so that when folded they are extremely compact. They can be used at low- and semi-low angle with a split center column, and come equipped with a removable head, rubber feet, tripod case and limited lifetime warranty.



TRIPODS

517

#### ULTRA MAXiF (VEUMF)

Weighing only 2 lbs., this five-section tripod reaches a maximum height of 60" and minimum height of 6.5". When folded it is a compact 14" and has a load capacity of 5 lbs. It includes a PH-237Q 4-way Revolver Panhead (quick release plate is QB-3) .....**129.95**

#### ULTRA MAXiSF (VEUMSF)

Weighing only 1.6 lbs., this five-section tripod reaches a maximum height of 48" and minimum height of 6.2". When folded it is a compact 12.8" and has a load capacity of 5 lbs. Includes PH-343 Ball-Socket Head .....**119.95**

#### ULTRA LUXiF (VEULF)

Weighing only 2.9 lbs. this five-section tripod reaches a maximum height of 63" and minimum height of 7.4". Folded it is a compact 15.3" and the load capacity is 6 lbs. with three bubble levels. It includes a PH-145Q 3-way Panhead (quick release plate is QB-145C) .....**139.95**

#### ULTRA LUXiSF (VEULSF)

Weighing only 2 lbs., the Ultra LUXiSF 5-section tripod reaches a maximum height of 47.6" and minimum height of 7". When folded it is a compact 13.4" and the load capacity is 6 lbs. It includes a PH-353 Ball-Socket Head .....**129.95**

### QRA-3 Quick Release Adapter

No more fumbling when using this affordable, lightweight and convenient quick release adapter. Designed for use with digital, film and video cameras, the



QRA-3 simply screws on to your panhead or ball-socket head, while the QB-3 quick release plate, screws into the bottom of your camera. The QRA-3 comes complete with the adapter and quick release plate, which both use a 1/4-20" screw. Weighing a mere 1.9 ounces this handy accessory is 2.4" long by 1.5" wide.

QRA-3 Adapter (VEQRA3) .....**28.95**

### ULTRA MAXiF & LUXiF SPECIFICATIONS

|              | Extended Height | Folded Length | Weight  |
|--------------|-----------------|---------------|---------|
| Ultra MaxiF  | 60"             | 14"           | 2.1 lbs |
| Ultra MaxiSF | 48"             | 12.8"         | 1.6 lbs |
| Ultra LuxiF  | 63.4"           | 15.3"         | 2.9 lbs |
| Ultra LuxiSF | 48"             | 13.4"         | 2.1 lbs |



### Replacement Quick Release Plates

#### QB145 Quick Release Plate (VEQB145):

For ULTRA LUXiF .....**13.95**

#### QB3 Quick Release Plate (VEQRPMAXI347):

For MAXi 347 Series .....**11.95**

ORDER & INFO. (212) 502-6340 • FAX: (212) 239-7770 (800) 947-7008  
**1-800-290-6750 • www.bhphotovideo.com**





# VELBON

## NEO CARMAGNE 730/740/830/840

TRIPODS

518

### 3-Section and 4-Section Tripods

The 3-section 730/830 and 4-section 740/840 Neo Carmagne (pronounced "Carmain"—stands for Carbon Fiber and Magnesium) tripods feature a state-of-the-art design that makes them ideal for SLRs and medium format cameras. The leg sections are constructed of superior carbon fiber tubing and Magnesium alloy, making them extremely lightweight, yet sturdy. The unique carbon fiber material is one-third lighter than traditional aluminum-based tripods and yields a level of strength that far surpasses iron or aluminum. In addition, its composition is excellent for absorbing vibration and resisting temperature changes. Each leg is equipped with durable urethane grip protective covers to prevent scratching.



- ◆ Weighing just over six pounds, the Neo Carmagne's body and other components are die-cast with magnesium alloy, creating a compact, well-built tripod.
- ◆ They can be set up quickly and effortlessly for any shooting situation, with the tripod's versatile and individually adjustable leg spread positions (standard, semi low-angle and full low-angle).
- ◆ Inner Jut Pipe system provides a convenient and fast method to setup and collapse the tripod's leg sections by eliminating the circular rotating motion that occurs when the leg locks are disengaged. This allows you to tighten or loosen the tripod leg sections independently.
- ◆ The legs come equipped with urethane grip protective leg covers to prevent scratching.
- ◆ Geared center column allows for precise adjustment and features a friction adjuster and elevator stopper.
- ◆ Available in black, the tripods also feature all metal rubber covered collar leg locks; rubber tipped, adjustable metal spikes; and a "free" stone bag for extra stability.

### NEO & EL CARMAGNE SERIES SPECIFICATIONS

|                    | 730 (VENC730) | 740 (VENC740) | 830 (VENC830) | 840 (VENC840) | 530 (VEEC530) | 540 (VEEC540) | 630 (VEEC630) | 640 (VEEC640) |
|--------------------|---------------|---------------|---------------|---------------|---------------|---------------|---------------|---------------|
| Maximum Height     | 74.25"        | 67.75"        | 78.7"         | 78.7"         | 64.7"         | 58.3"         | 68.5"         | 64.8"         |
| Minimum Height     | 6.4"          | 5.6"          | 13.8"         | 13.8"         | 10.2"         | 9.3"          | 9.4"          | 8.6"          |
| Folded Length      | 27.6"         | 22.8"         | 32"           | 26.7"         | 24.8"         | 20.4"         | 26.8"         | 22"           |
| Load Capacity      | —             | —             | 30 lbs.       | 30 lbs.       | 25 lbs.       | 25 lbs.       | 25 lbs.       | 25 lbs.       |
| Leg Sections       | 3             | 3             | 3             | 3             | 3             | 3             | 3             | 3             |
| Center Column Type | Rapid         | Rapid         | Geared        | Geared        | Rapid         | Rapid         | Rapid         | Rapid         |
| Weight             | 5.18 lbs.     | 5.07 lbs.     | 6.72 lbs.     | 6.83 lbs.     | 3.8 lbs.      | 3.7 lbs.      | 4.7 lbs.      | 4.6 lbs.      |
| Price              | \$479.95      | \$499.95      | \$599.95      | \$629.95      | \$289.95      | \$299.95      | \$329.95      | \$339.95      |



## EL CARMAGNE 530/540/630/640

### 3-Section and 4-Section Tripods

The 3-section 530/630 and 4-section 540/640 EL Carmagne extremely light, sturdy tripods have rigid carbon fiber legs, a durable magnesium body and magnesium panheads. Carbon fiber and magnesium materials are 1/4 lighter than aluminum. These versatile tripods have low- and semi low-angle positions with a split center column, as well as scratch-resistant Neoprene grips and rubber feet. The effortless Lever Lock system enables extending or contracting the legs at any position even in cold weather. The 530 and 540 come with the PH-250B 3-way panhead, the 630 and 640 come with the PH-460B 3-way pan head. They also include a tripod case, Stone Bag, accessory hook and lifetime warranty.

- ◆ Height-markings on lower two leg sections allow for more precise positioning
- ◆ Lower section detaches to allow full low-angle tripod positioning. The split center column lets the tripod to go down to 10.2"
- ◆ Tripod head can be mounted on either end of the center column
- ◆ Neoprene covering protects the top leg sections from scratches, and make them easier to use in extreme weather conditions
- ◆ Ideal for all 35mm applications except lenses larger than a 400mm f/2.8
- ◆ All metal, rubber covered collar leg locks and rubber tipped feet for no-slip setups.
- ◆ 2-section lift center for quick and easy height adjustment. Dual thread panhead mounting stud (3/8" and 1/4").
- ◆ They include an accessory hook and a "stone bag" (tripod apron), which can be used to add stability to the tripod.



# VELBON

## MAGNESIUM (Mg) TRIPOD HEADS

### PH-285 Magnesium 3-way Panhead (VEPH285)

An ideal companion for the Carmagne tripods, the PH-285 is a magnesium three-way panhead with separate pan/tilt and side tilt control handles. It is also equipped with removable handles for left and right side usage, and the interchangeable side tilt handle allows for 90° tilting in either direction. Weighs 3.3 lbs and supports loads up to 22 lbs.....**299.95**

### PH-253 Compact Ball Socket Head (VEPH253)

Compact ball socket head constructed of die-cast magnesium and aluminum. Features single lever operation. Base diameter is 1.7". Supports up to 6.6 lbs.....**59.95**

### PH-263QL Heavy-Duty Ball & Socket Head with Quick Release (VEPH263QL)

Made of diecast magnesium for light weight and strength, the PH-263QL supports up 8.8 lbs. and incorporates two bubble levelers making it suitable for 35mm & smaller medium format cameras. Single lever operation with panning and an adjustable position for the lock lever. The quick release plate can be installed in the clamp in either direction .....**139.95**

### PH-273QL Heavy-Duty Ball & Socket Head with Quick Release (VEPH273QL)

Same as above, except the PH-273QL supports up to 11 lbs.....**169.95**



TRIPODS

519

## MONOPODS

### UP-4DXII (VEUP4DX2):

Deluxe 4-section extruded aluminum leg with fluid tilt head, QB-4L quick release camera platform, forward facing control handle and adjustable neck/carrying strap. It weighs 24 oz., extends to 65" and folds to 22" ..**36.95**

### UP-43 (VEUP43):

Deluxe 4-section compact tubular leg with wrist strap, foam covered hand grip, quick side-lever leg locks, rubber tipped foot and a ball socket head. Weighs 16 oz., extends to 63" and folds to 20.5" .....**39.95**

### UP-40 (VEUP40):

Deluxe 4-section compact tubular leg with wrist strap, foam covered hand grip, quick side-lever leg locks rubber tipped foot and a direct mount camera platform. Weighs 12.3 oz., extends to 61" and folds to 18.3" .....**27.95**

### UP-4000 (VEUP4000):

4-section extruded aluminum leg with direct mount camera platform, wrist strap, polyurethane hand grip, quick side lever leg locks and an adjustable rubber foot with concealed steel ground spike. Weighs 14 oz., extends to 63" and folds to 20" ..**19.95**



### Neo Pod-6 (VEN6):

The ultra-light, 4-section carbon-fiber Neo Pod-6, weighs just 1.3 lbs., yet has superior load-bearing capabilities. It includes a velcro padded strap, which can be detached for use around your neck, and a Monopod Pocket that attaches to your belt for greater stability. The first leg section is covered with a scratch-resistant Neoprene Grip. It features an Accessory Hook, large rubber twist leg locks and a non-skid rubber foot. It has a maximum height of 60.2" and folds to 18.9" **109.95**

### NEO POD-7 (VEN7):

Same as the Neo Pod-6, but it has a maximum height of 66.9", folds to 20.9" and weighs 1.7 lbs.....**129.95**

## Magnesium (Mg) Tripod Accessories

### QRA-635L Quick Release Adapter (VEQRA635L)

Magnesium alloy quick release adapter with double bubble levels for 35mm cameras. Converts a conventional panhead to a quick-release head. Features a "Camera Safe" slide mounting quick-release platform with "Auto Lock" retaining system. Includes a standard 35mm plate.....**86.95**

### QRA-667L Quick Release Adapter (VEQRA667L)

Same as above except for medium format cameras as well as 35mm cameras. Includes a standard medium format plate.....**84.95**

### QB-635 Quick Release Plate (VEQB635)

Replacement for QRA-635L .....**Call**

### QB-635L Quick Release Plate (VEQB635L)

Replacement for QRA-635L. It features double bubble levels.....**49.95**

### QB-667 Quick Release Plate (VEQB667)

Replacement for QRA-667 .....**Call**

### QB-667L

### Quick Release Plate (VEQB667L)

Replacement for QRA-667L. It features double bubble levels for 35mm and medium format cameras .....**48.50**



### Super Mag Slider Macro Rail (VEMSM)

Magnesium alloy detachable 2-way focusing adjuster for precise camera positioning .....**99.95**

### Super Mag Plate (VEPM):

Two-camera adjustable magnesium mounting plate .....**74.95**

ORDER & INFO. (212) 502-6340 • FAX: (212) 239-7770 (800) 947-7008  
**1-800-290-6750 • www.bhphotovideo.com**



# WIMBERLEY

## THE WIMBERLEY HEAD

TRIPODS

520



### **Gimbal-type Tripod Heads**

The industry standard for serious nature photographers since 1991, the Wimberley Head is a specialized tripod head for telephoto lenses. A gimbal-type mechanism that allows you to perfectly balance and easily manipulate a long lens, the Wimberley Head is ideally suited for lenses similar in size to a 600mm f4. It will, however, adjust to fit virtually any telephoto lens with a rotation collar.

#### **How it Works:**

The Wimberley Head incorporates an elevated tilt mechanism and an adjustable platform to perfectly align the center of gravity of a big lens with the tilt axis of the head. This allows the lens to be perfectly balanced.

Perfect balance means that a 15 pound 600mm f/4 behaves as if it were weightless. Point the lens, let go, and it stays pointed at the target. Dynamic shots nearly impossible with a ball head are routine with a Wimberley.

With a properly adjusted Wimberley Head a photographer no longer has to wrestle with his or her big lens. Simply point... and shoot.

- ◆ Simple design of cast aluminum and stainless steel is durable and dependable. New "Super Tough" nylon alloy knobs are virtually indestructible. Catalyzed urethane finish. It weighs 3.7 pounds (without quick release).
- ◆ The Wimberley Head can adjust to fit virtually any telephoto lens with a rotation collar. It is ideal for lenses similar in size to a 600mm f/4, 400mm f/2.8, or 500mm f/4. You can attach your lens directly to the head, or you can use one of the quick release systems that Wimberley offers.
- ◆ The Wimberley Head screws to any tripod with a 3/8" mounting stud (this covers nearly every tripod on the market including all Gitzo and Manfrotto tripods). If your tripod has a 1/4" stud, you can adapt it to 3/8" by using the BS-100 brass bushing.



#### **Wimberley Head with Quick-Release**

This Wimberley Head comes with an Arca-Swiss style quick-release clamp attached to the head's mounting platform. The open-channel dovetail design of this quick-release system makes it possible to slide your lens forward and backward to achieve proper balance. To use this head, you must have an Arca-Swiss style quick-release plate on each lens that you intend to use on the head. It weighs 4.1 lbs.

**Wimberley Head with Quick-Release (WITHQR) .....564.95**

#### **Wimberley Head without a Quick-Release**

For those who prefer not to use a quick-release, or who wish to attach another type of quick release to the head, this head comes with mounting hardware to attach your lens directly to the head. It weighs 3.6 lbs.

**Wimberley Head without a Quick-Release (WIWTH) ....464.95**



**EQUIPMENT LEASING AVAILABLE**

# WIMBERLEY

## ACCESSORIES

TRIPODS

521

### The Sidekick

*Turn your ball head into a gimbal head in seconds*

Only 1.3 lb and compact enough to pack, the Sidekick quickly converts any ballhead with an Arca-style quick release clamp into a gimbal head. This allows the lens to rotate around its center of gravity, dramatically improving handling and vibration dampening.

Your percentage of 'keeper' shots will definitely go up using this device with telephotos with a tripod collar. Ideal for 300mm f/2.8 or 500mm f/4.5 lenses, but also works great with 70-200/f 2.8 telephoto zooms or macro lenses with tripod collars such as the 180mm f/3.5 and 400mm f/5.6's made today. When the tripod collar is fitted in the Sidekick properly, you will have perfect 50/50 weight distribution, making movement of the lens and camera finger-light!

The Sidekick, along with any ballhead with an Arca-type quick release clamp and independent panning lock as well an appropriate quick release plate, makes for an incredible combination to provide control of spotting scopes. This is likely the best possible scenario for tracking a bird in flight, but will require a spotting scope with a rotating tripod collar in order to be ergonomically practical.



- ◆ Simple design of cast aluminum and stainless steel is durable and dependable.
- ◆ "Super Tough" nylon alloy knobs are virtually indestructible.
- ◆ Catalyzed urethane finish.
- ◆ Comes with a built-in Arca style quick release.
- ◆ Weighs 1.3 pounds.
- ◆ The Sidekick is designed for lenses similar in size to a 300mm F2.8 (including most 500mm lenses). Note: The Sidekick will accommodate some 600mm F4 and 400mm F2.8 lenses by replacing the lens mounting foot. Call if you are interested in doing this.

### The Plamp

*The Wimberley Plant Clamp*



Finally a way to stabilize those aggravating windblown subjects! A must for any macro enthusiast, the Plamp is an easily positionable arm used to hold macro and other useful objects. One end clamps to your tripod while the other grasps the object.

One day in the field with a Plamp (or two) and you'll soon realize its full potential. The Plamp weighs 5oz. and has a length of 22". (The length can be altered by adding or removing arm segments).

#### Use the Plamp to:

- ◆ Stabilize windblown subjects
- ◆ Adjust the position or angle of your subject
- ◆ Move background objects and obstructing foliage
- ◆ Hold reflectors, graduated filters, and lens shades



**The Plamp (WIPAA) .....36.95**

### P-5

*Universal Camera Body Plate*

The P-5 is a simple universal plate that provides the same quality of construction, solid connection, and anti-twist characteristics of custom plates. It features a thin layer of dense, textured rubber on its top surface that grips the bottom of your camera, but is so dense and thin, that it maintains the same solid feel that you get with a metal-to-camera connection.



Beneath the rubber, the top surface of the plate has a wide, shallow cut-out running across the middle of the plate that insures that the plate is solidly attached to your camera body, and won't twist.

- ◆ Use the P-5 on your camera with or without the vertical grip attached
- ◆ Use for backup camera bodies, point-and-shoot cameras, medium format cameras, and even collared lenses
- ◆ The P-5's thin profile and generously rounded corners make it easy on the hands; blends beautifully with the contours of your camera.

**P5 Universal Camera Body Plate (WQRP5).....52.00**

# WIMBERLEY

## FLASH BRACKETS

TRIPODS

522

Wimberley flash brackets bring a new level of convenience, versatility and portability to the world of flash photography. Their unique modular design allows you to add components and reconfigure your brackets to meet nearly any need. The components of the system connect to one another simply and securely without tools. Components are milled from solid 6061 T6 aluminum and are black anodized. Connections are solid and cannot twist, creep, or slip apart. All knobs are captive. Designed to integrate with the Arca-Swiss style quick release system, you can attach the brackets to any lens with a long Arca-Swiss style plate or even to your camera body plate. The brackets work particularly well with Wimberley lens plates. The modular design allows you to easily disassemble any bracket for convenient storage. It also allows you to adjust the size of the bracket to fit different sized lenses or to mix and match parts to form different brackets for different needs.



### F-1 Telephoto Bracket (WIF1)

Consisting of modules M1, M2 and M3, the F-1 Telephoto Bracket attaches to the quick-release plate of any lens. It can be used on a ball head or the Wimberley Head, or reconfigured to work on the Sidekick. Add other modules to add macro capability or to form a quick-flip wedding bracket .....**195.95**

### F-2 Macro Bracket (WIF2)

Consists of modules M1 & M4. The articulating arm on this bracket is comprised of two double ball and socket links that lock positively and offer a great range of flash positions. Bracket attaches quickly to your lens or camera body plate with a narrow Arca-Swiss style quick-release. Adding the M-8 plate makes it more convenient to use this bracket on your camera .....**168.95**

### F-3 Telephoto/Macro Kit (WIF3)

Consists of the F-1 Telephoto Bracket and M4 Macro Arm allowing you to form either the F-1 Telephoto Bracket or the F-2 Macro Bracket. (You can't form both brackets at the same time.) You can also attach the M-4 to the top of the telephoto bracket for added reach and positionability .....**298.95**

### F-4 Wimberley Head Bracket (WIF4)

Consists of modules M3 and M5 and makes setting up telephoto flash easy. It attaches directly to the swinging arm of the Wimberley Head. Since it is attached to the head and not your lens, it remains in place when you switch lenses .....**185.95**

### F-6 Sidekick Bracket (WIF6)

Consists of modules M1 & M3. It positions the flash above the lens when using side-mounted gimbal heads such as the Sidekick. (Note: If you want a bracket that will work on the Sidekick and on your ball head, the F-1 Telephoto Bracket can be configured for either task) .....**151.95**

*System consists of 8 modules. The modules can be configured to form many different flash brackets. You don't have to buy all of the modules, and you can easily expand the versatility of your setup by adding more pieces at any time.*

**Module 1: Quick Release Arm (WIM1)**  
Attaches to the Arca-Swiss quick-release plate on your lens or camera body ....**64.95**

**Module 2: The Upright (WIM2)**  
Forms the vertical upright for the F-1 Telephoto Bracket .....**43.95**

**Module 3: Tilt Arm (WIM3)**  
Serves as the tiltable attachment point for your flash for telephoto brackets .....**85.95**

**Module 4: Macro Extension Arm (WIM4)**  
Extremely positionable arm for advanced telephoto work .....**102.95**



**Module 5: Head Module (WIM5)**  
Serves as the vertical upright and quick-release attachment for the F-4 Head Bracket. It folds for easy storage and connects directly to the swinging arm of the Wimberley Head .....**99.95**

**Module 6: Extension Post (WIM6)**  
This module can be added to any of the telephoto brackets to increase the height of your flash .....**42.95**

**Module 7: Flash Flipper (WIM7)**  
Add this module to the F-1 Telephoto Bracket to easily flip your flash for vertical and horizontal shots .....**88.95**

**Module 8: Perpendicular Plate (WIM8)**  
Lets you attach the F-1 or multiple F-2 brackets to your camera. Also use as a small macro slider for making small forward-backward adjustments for macro photography .....**84.95**



# WIMBERLEY

## ACCESSORIES

### Quick Release Plates

Wimberley's line of Arca-Swiss style quick release plates for collared lenses offer a host of innovative features that separate them from other plates on the market. They have safety stops at the front and back of the plate to prevent your expensive lens from accidentally slipping out of the quick release clamp, and are long enough so that there is enough distance between the two stop screws to straddle the length of most quick release clamps.

- ◆ A double dovetail cross-section allows you to attach Wimberley's flash brackets to the upper or lower surface of the plate.
- ◆ They accept RRS & Kirk flash brackets as well as Wimberley's own quick-release flash brackets.
- ◆ Slots accommodate multiple fasteners and fastener positions to orient the plate on the lens foot to best fit your needs. Hang the plate off the front or back of the lens foot to attach flash brackets to the plate. Adjust the position to best suit the balance point of your lens. Since the plates are universal, you don't have to buy a new plate if you switch to a different lens.
- ◆ Each plate comes with the hex key needed to attach the plate to your lens, safety stop screws for the front and back of the plate, and the hex key necessary to install the safety stop screws. The plates attach to your lens with 1/4" captive fasteners.
- ◆ The P-10, P-20, and P-30 plates have anti-twist nubs at the back of the plate to keep the plate from twisting if it is mounted with only one fastener. The larger P-40 and P-50 plates don't, because it is assumed that they will be attached with multiple fasteners.

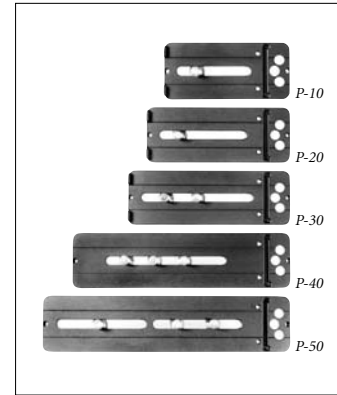

- P-10 (WIQRPP10):** 3.3" .....**51.95**
- P-20 (WIQRPP20):** 3.9" .....**51.95**
- P-30 (WIQRPP30):** 4.4" .....**54.95**
- P-40 (WIQRPP40):** 5.9" .....**57.95**
- P-50 (WIQRPP50):** 6.5" .....**57.95**

### Quick Release Clamps



Wimberley's quick release clamps have a unique tongue-in-pocket design that protects internal parts from dust and grit. The tongues are nearly twice as long as those on conventional Arca-Swiss style clamps. This added length counteracts the tendency of the moving jaw of the clamp to hinge backward during clamping, thus keeping the jaws aligned with the geometry of the plate and eliminating unwanted bending forces on the threaded stud.

- ◆ There is a stop screw located on the end of the stud. This screw keeps the knob and internal workings of the clamp captive.
- ◆ Two shallow channels extend from the sides of the clamp and stop just short of the central tapped hole. These channels allow greater fore-aft adjustment when using the safety stops on Wimberley quick-release plates.

**C-10 Quick-Release Clamp (WIQRCC10)**  
The C-10 clamp is 2.5" long, and has a central 3/8" threaded hole that can be used to fasten it to a tripod or any equipment requiring a quick-release clamp. It also has three 1/4" threaded holes, allowing you to use multiple fasteners or set screws to keep the clamp from twisting. It includes one set screw and a wrench making it easy to keep the clamp from twisting, and a 3/8" to 1/4" brass reducer bushing .....**78.95**

**C-30 Quick-Release Clamp (WIQRCC30)**  
Made specifically for the Wimberley Head, the C-30 is 4.1" long and attaches with two 3/8" stainless steel screws. The two fasteners prevent it from moving or twisting once installed. The C-30 comes with all the hardware and tools needed to fasten it to the head. You can also attach the C-30 to other equipment for applications where you desire a long clamp. The clamp has three 3/8" threaded mounting holes.....**99.95**

### Replacement Feet

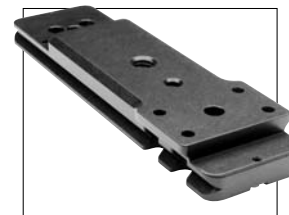

These custom low-profile replacement feet lower the center of gravity of large lenses and make them easier to pack.

The replacement feet have the same dual safety stops and flash bracket compatibility as Wimberley's lens plates. They are milled to slide right into an Arca-Swiss style quick-release clamp, and also have 1/4" and 3/8" tapped holes for mounting to non-quick-release tripod heads and monopods. All tools needed to replace your existing lens foot are included.

**AP-452 (WIFN400):** For Nikon 400 f/2.8 AF-S I/II, and 600 f/4 AF-S II. Lowers the overall height of the lens by about 2" .....**78.95**

**AP-553 (WIFN500):** for Nikon 500 f/4 AF-S I/ II, and 200-400 f/4 AF-S VR. Lowers the overall height of the 500 f/4 by about 2" and 1.25" for the 200-400 f/4 .....**78.95**

**AP-652 (WIFN600):** For Nikon 600 f/4 AF-S I (the 600 f/4 AF-S II uses AP-452). Lowers the overall height of the lens by about 1" .....**78.95**

**AP-602 (WIFC600):** For Canon 400 f/2.8 IS and 600 f/4 IS. Lowers the overall height of the lens by about 1.5" .....**78.95**









# The 35mm SLR Photo

SourceBook

# Section 6

## Bags

|                        |         |
|------------------------|---------|
| Billingham .....       | 526-529 |
| Delsey .....           | 530-533 |
| Domke .....            | 534-538 |
| f.64 .....             | 539-542 |
| Hakuba .....           | 543     |
| Kata .....             | 544-549 |
| Lightware .....        | 550-559 |
| Lowepro .....          | 560-577 |
| Op/Tech .....          | 578-582 |
| Pelican .....          | 583-585 |
| Porter Case .....      | 586-587 |
| RoadWired .....        | 588-590 |
| Tamrac .....           | 591-607 |
| Tenba .....            | 608-616 |
| VidPro .....           | 617-618 |
| Zero Halliburton ..... | 619     |
| Zing .....             | 620-621 |

## Folding Carts

|               |     |
|---------------|-----|
| Remin .....   | 622 |
| Ruxxac .....  | 623 |
| Clipper ..... | 623 |

# BILLINGHAM

## SHOULDER BAGS

BAGS

526



*Recognized throughout the world as the ultimate blending of function and style, Billingham bags are designed and handcrafted in England.*

*They feature a soft, yet protective canvas which is repellent to the elements but inviting to the photographer. It will hug your body and safeguard your gear. The sides and base are padded with high density closed-cell foam to absorb bumps and knocks. Unique StormBlock waterproof lining within the canvas*

*keeps your equipment dry. Billingham uses top-grain leather hides in their bags which are tanned and dyed by hand to bring out the natural grain of the skin.*

### 225, 335, 445 and 555 Shoulder Bags

The 225, 335, 445 and 555 all feature a main compartment that is framed internally with 4-ply Nytex binding which maintains the bag's shape and helps to channel rainwater away from the seams. The TukTop allows the main zipper, with it's double pullers, to be tucked out of the way when opened. Additional protection against the elements is provided by the leather-bound rain flap with twin top-grain leather tabs and Quick Release System fastenings. Double grip handles allow the bag to be picked up instantly, even if the rain flap is open. The zippered front pocket has two padded internal pockets. All of these models feature the Five Loop Fixing system so that you can attach the optional Back Pack Harness or Tripod Straps. The



Delta Sling is designed to prevent the bag from tipping and to reduce any rolling motion as you move, no matter how heavily the front pocket is loaded.

**225 Shoulder Bag:** The 225 is 12.5 x 8.5 x 9" and includes an 8-15 partition. It is available in Black (BI225B), Khaki (BI225K) and Olive (BI225O) colors with Tan trim. A Nytex version is also available in Stone with Tan trim (BI225S) .....**314.95**

**335 Shoulder Bag:** The 335 is 14.25 x 8.5 x 10" and includes the 8-15 and 9-18 partitions. It is available in Black with Black trim (BI335B), and Khaki (BI335K) and Olive (BI335O) colors with Tan trim. Two Nytex versions are also available: Black with Black trim (BI335BQ) and Stone with Tan trim (BI335S) .....**339.95**

**445 Shoulder Bag:** The 445 is 16.5 x 8.5 x 12.5", and includes the 9-15 and 9-18 partitions. It is available in Black with Black trim (BI445B), and Black (BI445B), Khaki (BI445K) and Olive (BI445O) colors with Tan trim. Two Nytex versions are also available: Black with Black trim (BI445BY) and Stone with Tan trim (BI445S) .....**394.95**

**555 Shoulder Bag:** The 555 is 8.5 x 8.5 x 12.5" and includes the 8-15, 9-15 and 9-18 partitions. It is available in Black with Black trim (BI555BB), and Black (BI555BT), Khaki (BI555K) and Olive (BI555O) colors with Tan trim .....**474.50**

### 550 Shoulder Bag

A versatile soft camera bag with enough room for demanding assignments. It features two full height zippered pockets, two gusseted pockets, a zippered external back pocket, two detachable end pockets and an adjustable shoulder sling. The top flap completely protects the main compartment. The 550 includes 8-15, 9-15 and 9-18 Superflex removable partons. It's external dimensions are 18 x 11 x 11.5"; it's internal dimensions are 17.5 x 5.75 x 10" without the end pockets attached. It is available in Black with Tan trim (BI550B), Khaki (BI550K), and Olive (BI550O). It is also available in tough, robust Stone colored Nytex with Tan trim (BI550S). It weighs 5.73 lbs .....**429.95**



550 Shoulder Bag

### Rucksack 25

A stylish, compact backpack with an easy-access main compartment that endures all types of weather. Abundant craftsmanship details include hand-polished brass fittings, soft waterproofed canvas and supple, tanned leathers. Inside, high density closed-cell foam cradles your equipment. Leaving both arms free, the 25 Rucksack gives you maximum freedom of movement, as well as keeping you well balanced. 13 1/4 x 9 1/4 x 15 1/4". Available in Black (BI25RB) and Khaki (BI25RK) colors ..**288.00**



Rucksack 25



**ONE HOUR FREE PARKING**  
**AT 349 W. 34th STREET** (with purchase of \$100 or more)

# BILLINGHAM

## PRESSTOP "MEDIA" SYSTEMS

### 106, 206, 306 "Media" Systems

These are the first of a new generation of Billingham bags, and are rapidly proving to be most popular. Constructed from softweave canvas, they are lightweight and hard-wearing and feature the Billingham PressTop. The ingenious design of these bags actually allows the bag top to extend an additional 3" in height with a quick double-snap, which gives the photographer easy access to equipment on the move, or in crowded situations. This feature also addresses larger photo equipment such as an SLR with an attached "handle mount" flash gun. In addition, when the bag top is lowered and secured by the same two side snaps, access to your equipment by others is virtually impossible. These bags feature dual handles with a leather grip, a quick-release system, softweave waterproof canvas and Superflex partitions / external pockets.

**106 Shoulder Bag:** The 106 is 11 x 7 x 9" and weighs 2.6 lb. It is available in Black with Black trim (BI106B) and Khaki with Brown trim (BI106K).....**264.95**

**206 Shoulder Bag:** The 206 is .....12.5 x 7 x 9" and weighs 3.5 lb. It is available in Black with Black trim (BI206B) and Khaki with Brown trim (BI206K) .....**285.00**

**306 Shoulder Bag:** The 306 is .....14.5 x 6 x 8.5" and weighs 4.4 lb. It is available in Black with Black trim (BI306B) and Khaki with Brown trim (BI306K) .....**307.95**



**BAGS**

**527**

**Packington  
Shoulder Bag**



The stylish Packington shoulder bag is the comfortable way to carry cameras, laptops or video cameras, and doubles as a roomy travel bag. It's the ideal companion to accompany you on a voyage around the world. Roomy zippered front pockets are completely protected by a large rain flap with the Quick Release System. The entire front pocket is made from a single piece of canvas, darted to give additional volume. A zippered main compartment contains a detachable, padded photo insert, which has been designed to leave room for additional expedition clutter. The zippered, external back pocket provides storage for documents. An adjustable waist strap attaches securely to prevent the bag swinging and for extra security. External dimensions are 16 1/2" x 6 1/4" x 12 1/4"; internal dimensions are 13 1/4" x 4 3/4" x 9 1/4". It weighs just 3.75 lbs. It is available in Black

(BIPBQ), Khaki (BIPKQ) and Olive (BIPOQ) colors with Tan trim.....**274.95**

### Photo Hadley Series Shoulder Bags

The Photo Hadley is a roomy, well-equipped camera bag that can double as a business case. The Hadley Large and Pro bags are big enough to handle a laptop computer. The Hadley Pro features a zippered back pocket with a protective rain flap, a carrying handle and the ability to accept optional AVEA pockets. The Hadley Small can be a well-equipped camera bag, or, with the photo insert removed, a business case. Hadley bags will provide years of service. They all feature bellowed front pockets with press stud expansion, quick-release closure, two expandable exterior pockets, a solid brass clog bolt and harness leather locking system, Stormblocker dual laminate waterproof canvas exterior, a quick-fold top for immediate access to your gear, the Superflex partition system with included dividers, side weather flaps, and an extra-large front cover flap.

**Small Hadley Bag:** The Small Hadley is 11 1/2" x 4 1/2" x 8 1/2" and weighs 1.5 lb. It is available in Black with Black trim (BISHBB), and Black (BISHBT), Khaki (BISHK) and Olive (BISHO) with Tan trim.....**189.00**

**Large Hadley Bag:** The Large Hadley has dimensions of 14 1/2" x 5 x 10", and it weighs 3.2 lb. It is available in Black (BILHB), Khaki (BILHK) and Olive (BILHO) colors with Tan trim. A Nyltex version is available in Stone color with Tan trim (BILHS) .....**179.95**

**Pro Hadley Bag:** It's dimensions are 13 1/2" x 4 1/2" x 9 1/2" and it weighs 1.9 lb. It is available in Black with Black trim (BIPHBB), and Black (BIPHBT), Khaki (BIPHK) and Olive (BIPHO) colors with Tan trim. A Nyltex version is available in Stone with Tan trim (BIPHS) .....**199.95**



**ORDER & INFO. (212) 502-6340 • FAX: (212) 239-7770 (800) 947-7008  
1-800-290-6750 • www.bhphotovideo.com**



# BILLINGHAM

## SHOULDER BAGS

BAGS

### L2 SHOULDER BAG



Designed for smaller SLR or rangefinder systems, the weatherproof L2 incorporates the design features found in the entire Billingham line.

Designed without zippers, the L2 provides lots of space and protection, a Quick Release closure, a solid brass clog bolt and a harness leather locking system. It has a StormBlocker dual laminate waterproof canvas exterior, a quick-fold top for easy access to gear, a Superflex partition system with included dividers, an interior back pocket, and gusseted front pocket and side weather flaps. Its external dimensions are 10½ x 5¼ x 7¾"; its internal dimensions are 9" x 4¼ x 5¼", and it weighs 1.75 lbs. The L2 accepts optional Avea pockets on either or both ends, and is available in Black with Black trim (BIL2BB), and Black (BIL2B), Khaki (BIL2K), or Olive (BIL2O) with Tan trim.....**187.95**

### PHOTO EVENTER



Made from StormBlock dual laminate waterproof canvas, the Photo Eventer top end camera case features an all leather "wrap around" bottom and an interior padded divider sized for your laptop computer. It has extra wide pocket gussets, the QRC Quick-Release closure and a zippered external back pocket. It is available in Black (BIPEB), Olive (BIPEO) or Khaki (BIPEK) colors. Dimensions are 15 x 7 x 12" and it weighs 3.7 lbs.....**394.00**

## SUPERFLEX PARTITIONS

528

Protect your equipment from bumps and knocks with Billingham's SuperFlex partitions. SuperFlex is constructed of non-abrasive anti-fray material which covers non-absorbent closed cell foam. The compartments separate and protect your camera equipment while inside your Billingham Camera Bag. Choosing the right size is easy. All you need is two dimensions; the first number being the diameter and the second being the height (in centimeters). Available in olive color.

| Model | SKU       | HxD        | Price |
|-------|-----------|------------|-------|
| 10-15 | BISPO1015 | 5.75 x 3¾" | 26.95 |
| 10-18 | BISPO1018 | 6" x 3¾"   | 26.95 |
| 10-21 | BISPO1021 | 7.5 x 3¾"  | 26.95 |
| 11-15 | BISPO1115 | 5¼ x 4¼"   | 26.95 |
| 11-18 | BISPO1118 | 6" x 4¼"   | 26.95 |
| 11-21 | BISPO1121 | 10½ x 4¼"  | 26.95 |
| 12-21 | BISPO1221 | 6" x 4¾"   | 29.95 |



| Model | SKU      | HxD        | Price |
|-------|----------|------------|-------|
| 6-12  | BISPO612 | 4" x 2¾"   | 23.95 |
| 7-15  | BISPO715 | 5" x 2¾"   | 23.95 |
| 8-15  | BISPO815 | 5¾ x 3¾"   | 23.95 |
| 8-18  | BISPO818 | 6" x 3¾"   | 23.95 |
| 9-15  | BISPO915 | 5" x 3.5"  | 23.95 |
| 9-18  | BISPO918 | 6" x 3.5"  | 23.95 |
| 9-21  | BISPO921 | 21½ x 3.5" | 23.95 |

## SIMPLIES LENS POUCHES

These simple little pouches are a great way to protect your valuable lenses, sunglasses and film from dust, dirt or sand. These adjustable draw string pouches feature a rugged, double wall, waterproof exterior, which is hand stitched to an all leather bottom. They weigh next to nothing! The olive colored Simplies are available in seven sizes. The first number relates to the base diameter and the second to the height (in centimeters).



| Model   | SKU         | HxD        | Price |
|---------|-------------|------------|-------|
| 70/140  | BILPS70140  | 3" x 2.75" | 28.50 |
| 80/170  | BILPS80170  | 6" x 3¾"   | 24.95 |
| 90/195  | BILPS90195  | 7.5 x 3.5" | 29.95 |
| 100/160 | BILPS100160 | 6.25 x 3¾" | 29.95 |
| 100/220 | BILPS100220 | 8.5 x 3¾"  | 32.50 |
| 100/270 | BILPS100270 | 10.5 x 3¾" | 32.50 |
| 130/170 | BILPS130170 | 6" x 5"    | 32.50 |



www.bhphotovideo.com

# BILLINGHAM

## PARTITIONS & ACCESSORIES

### POUCHES & POCKETS

**Avea Pockets** are padded canvas pockets that fit many Billingham bags or can be attached to your belt. They are waterproof, padded and have a draw string neck. The **Avea 3** is 3 x 1.5 x 6", weighs 3.5 oz. and is available in Black with Black trim (*BIA3B*), and Black (*BIA3BT*), Khaki (*BIA3K*) and Olive (*BIA3B*) with Tan trim. The **Avea 5** is 5 x 2.5 x 7", weighs 7.1 oz. and is available in Black with Black trim (*BIA5BB*), and Black (*BIA5TB*), Khaki (*BIA5K*) and Olive (*BIA5BO*) with Tan trim. The **Avea 6** is the same as the Avea 5, but made from Softweave canvas. It is available in Black with Black trim (*BIA6B*) and Khaki with Tan trim (*BIA6K*).....**55.95**

**Delta Pockets** are 5.5 x 2.5 x 8", weigh 7.1 oz., and are ideal to use on the Billingham 225, 335, or 445 camera bags. They are padded, waterproof and have an additional draw string closure for extra weather protection. They can also be attached to your belt to carry an point and shot camera, film, etc. They are available in Black with Black trim (*BIDEP225BQ*), and Black (*BIDEP225B*), Khaki (*BIDEP225K*) and Olive (*BIDEP225O*) with Tan trim. A Nytex version is available in Stone with Tan trim (*BIDEP225S*).....**59.95**

The **Compact Stowaway** is 6.25 x 2.5 x 8.25" and weighs 10.6 oz. It has lots of securely zippered pockets with a padded main compartment. It is waterproof, trimmed with solid brass fittings, and has the famous Quick Release Closure System, Adjustable shoulder strap and belt loops. Available in Black (*BICB*), Khaki (*BICK*) and Olive (*BICO*) with Tan trim.....**109.95**

Similar to the Compact Stowaway, the **Airline Stowaway** is 6.5 x 2.5 x 9.5" and weighs 17.6 oz. It is available in Black (*BIALB*), Khaki (*BIALK*) and Olive (*BIALO*) with Tan trim .....**103.95**

The **Pola Stowaway** is the same as the Compact and Airline Stowaways, except it is 7 x 3.25 x 8.25" and weighs 10.6 oz. It is available in Black (*BIPB*), Khaki (*BIPK*) and Olive (*BIPO*) colors with Tan trim .....**116.50**



Avea & Delta Pockets



Compact, Airline and Pola

BAGS

529

### ACCESSORIES



**Waist Strap Attachment:** Wraps around the waist and attaches to the side of the bag providing extra security and comfort. Available in Tan/Khaki/Brass (*BIWSATK*) or Black/Tan/Nickel (*521901-70*)..... **48.95**

**Luggage Tag:** All leather and brass, handcrafted, name tag. Available in Black (*BILT*) or Tan (*BILT*) colors .....**19.95**

**Hadley Straps:** Pair of replacement main flap straps for all Hadley models. Available in Black (*528001*) or Tan (*BIFSH*) colors .....**29.95**

**SP-10 Shoulder Pad:** 1" padded leather shoulder pad. Available in Black (*BISP10B*) or Tan (*BISP10T*) .....**34.95**

**SP-15 Shoulder Pad:** Same as above, but 1.5". Available in Black (*BISP15B*) or Tan (*BISP15T*) .....**38.95**

**SP-20 Shoulder Pad:** Same as above, but 2". Available in Black (*BISP20B*) or Tan (*BISP20T*) .....**39.95**

**Tripod Straps:** Pair of leather straps, finished by hand, to attach to your bag. Available in Black (*BITSB*) or Tan (*BITST*).....**33.50**

**Back Pack Harness:** Designed to attach to the five loops on the 225, 335, 445, 206 and the Packington shoulder bags. It enables these bags to be carried in an upright position on the back. Available in Black (*BIBPHB*) or Khaki (*BIBPHK*) .....**72.95**

**Hadley removable Insert:** removable for all Hadley bags. Please specify which bag when ordering .....**59.95**

ORDER & INFO. (212) 502-6340 • FAX: (212) 239-7770 (800) 947-7008  
1-800-290-6750 • www.bhphotovideo.com



# DELSEY

## PRO COLLECTION

BAGS

530

The Delsey Pro collection is a unique professional bag collection that combines protection and function with eye-catching elegant design. These bags are manufactured with a Ballistic/ Nylon/Polyester fabric mix over a PVC sponge backing and are padded on all sides with waterproof fabric that will protect your gear for years to come. These streamline bags have no exterior stitching plus with comfortable to hold, hide-a-way handles the PRO collection is a pure first class travel companion.

### PRO COLLECTION DETAILS

- ◆ The Hide-a-way handles design produces a style so streamlined you'll need to look twice to see just how these handles stow away.
- ◆ Parallel zipper tracks give you the choice to have the handles in use or not and still neatly close the bag.
- ◆ Exterior zippers are designed with a smooth reverse closure system that creates an external and internal water resistant zipper cover eliminating the traditional cumbersome zipper flaps
- ◆ Bags are readily able to attach tripods of various sizes.
- ◆ Inserts are removable for specific functions to protect and consolidate your gear. Remove the insert and you have a stylish piece of luggage or garment bag.
- ◆ Supplied with padlocks which loop through the lockable zippers.
- ◆ Multi-pocketed organizer sections provide secure transport for a wide range of accessories.
- ◆ Extreme Weather Cover provides extra protection in extreme weather conditions. Cover stows away in a zippered pocket when not in use.
- ◆ Shock dispersing air-channeled hard plastic bottoms with shock absorbing closed-cell foam padding and rubberized feet.
- ◆ Large side pockets with room enough to hold, protect and organize.
- ◆ Detachable film pouch allows you to stow away your exposed film in a secure pouch. (Pro Bag 1, 2 and 3)
- ◆ A 2" wide adjustable shoulder strap with a padded skid proof ergonomic shoulder pad ensures comfort and protection. The straps are sewn completely around the bag for strength and then covered with the outer fabric leaving only the eye hooks exposed to attach the removable part of the strap.
- ◆ Inside and out the PRO collection has classic clean lines. Even the material used throughout the inside is elegant, a repeat pattern of Delsey over a fine gray material.
- ◆ The padded modular removable interior dividers are completely flexible to fit your individual requirements. For protection of electronic accessories and digital media a woven anti-static mesh is used.

**Pro Bag 1 (DEPB1):** Customizable interior with room for professional SLR and/or medium format camera systems, lenses and gear, pro flash, light meter and many more accessories. It features a front organizer section, a zippered top mesh pocket, two side pockets, detachable film pouch, hide-a-way handles, tripod carry system, padded shoulder strap and padlock. Interior dimensions are 19 x 9½ x 11½" (LHD). Exterior dimensions are 22½ x 11½ x 13½" (LHD). It weighs 8½" .....**175.00**

**Pro Bag 2 (DEPB2):** Customizable interior with room for two pro SLR's with attached lenses, 4 to 5 additional lenses, pro flash, light meter, many more accessories and zippered top mesh pocket. 16 x 8 x 9½" Internal dimensions. 20 x 9 x 12½" (LHD) external dimensions. It weighs 5¼ lbs .....**125.00**

**Pro Bag 3 (DEPB3):** Same as the Pro Bag 2, but a bit smaller. 11½ x 7½ x 8½" interior; 16½ x 8 x 11½" (LHD) exterior. It weighs 4½ lbs .....**107.00**

**Pro Bag 4 (DEPB4):** Customizable interior with room for a pro SLR with an attached lenses, additional lenses, pro flash, light meter, and many more accessories. Zippered top mesh pocket. Interior dimensions are 11 x 6½ x 8"; external dimensions are 12½ x 8 x 9½" (LHD). It weighs 3 lbs.....**49.95**

**Pro Bag 5 (DEPB5):** The most compact bag of the Pro Collection, the Pro Bag 5 is the perfect carry-on companion for any flight. It features a front organizer section, two side pockets, a tripod carry system and a padded shoulder strap. Its interior dimensions are 7½ x 5 x 5"; external dimensions are 11.5 x 7 x 7½" (LHD). It weighs 2.5 lbs .....**63.95**



For Any Inquiries Regarding Your Order, Call Our Customer Service:  
(800) 221-5743 • (212) 239-7765 • FAX: (800) 947-2215 • (212) 239-7549

# DELSEY

## PRO COLLECTION

BAGS

531

### **Pro Trolley 52** (DEPT52)

Customizable interior with room for professional SLR and/or medium format camera systems, lenses and gear, pro flash, light meter and many more accessories including a notebook. A removable photo insert protects and consolidates your gear. Remove the insert and you have a rolling garment trolley. It features a front organizer section, notebook section, tripod carry system, heavy-duty telescoping handle with a rubberized grip, ball-bearing wheels, and separate padlocks to secure the separate photo insert section and notebook section. Internal dimensions are 13 x 17¼ x 6". Exterior dimensions are 15½ x 19¼ x 9½". It weighs 11 lbs.....**186.00**



### **Pro Trolley 50** (DEPT50)

Like the larger Pro Trolley 52, the new Pro Trolley 50 offers a protective interior that provides ample room for a professional SLR and/or medium format camera systems, additional lenses, flash unit, light meter and lots of extra gear. It also features a convenient notebook section and a front organizer section for PDAs, cell phones, business cards and all the other tools of the trade. Internal dimensions are 11 x 4.75 x 14.5". Exterior dimensions are 11½ x 9 x 17.75". It weighs 10.25 lbs.....**139.95**

### **Pro Photo Notebook Expandable Briefcase 16** (DEPPN16)



This briefcase features a removable padded insert that protects your photo gear. Ample room for a digital still or video camera, or pro 35mm, with additional lenses, or compact camcorder, pro flash, light meter and all the traveling essentials you need. A padded main compartment can hold a notebook and files when the removable photo insert is not in use. The briefcase features a removable photo insert, a front organizer section with multiple pockets and zippered mesh pouch, a padded shoulder strap, an easy access zippered rear newspaper compartment, hide-a-way handles, and a tripod carry system. Internal dimensions are 15½ x 11 x 5". External dimensions are 16¼ x 12½ x 6¼" (LHD). It weighs 4½ lbs .....**87.00**

### **Pro Notebook Briefcase Expandable 12** (DEPN12)

Customizable interior with room for notebook computers with screens up to 16", power supply and mouse, PDA and cell phone, CDs in jewel cases, paperwork and files, pens, keys, business cards and all the traveling business essentials you need. Plus a 3" expandable section that could hold an overnight change or additional papers. Internal dimensions are 15½ x 11 x 6". External dimensions are 16 x 12½ x 7" (LHD). It weighs 4½ lbs .....**94.00**

### **Pro Digital Backpack 33** (DEPD33)

Ample room for 1 or 2 pro digital or pro 35mm cameras, with additional lenses, pro flash, light meter, notebook computer, and all the traveling essentials you need. It features a padded main compartment



*The adjustable harness system provides superior back support. Well padded shoulder straps, chest and waist belts, shoulder, back, and waist supports create air channels which keep your back cool and ensure your comfort all day.*

that safely holds all your photo gear, a padded notebook compartment that protects all other electronics, a front organizer section with multiple pockets and zippered mesh pouch, a padded adjustable harness system, an extreme weather cover, a tripod carry system and two padlocks (one for the camera system compartment and one for the notebook compartment).....**155.00**



**ORDER & INFO. (212) 502-6340 • FAX: (212) 239-7770 (800) 947-7008  
1-800-290-6750 • www.bhphotovideo.com**





# DELSEY

## GOPIX

The GOPIX collection provides specific travel solutions to meet the demands of enthusiasts throughout the world for ease of use and protection. These streamline fashionable bags have no exterior stitching. They are comfortable to hold in your hand, on your shoulder, or through your belt. Whatever your pursuit, there's a Gopix bag ready to take the load.

All Gopix bags are available in three color combinations. Pick black/red for its striking color, slate green/blue for a sophisticated statement or classic black /gray for business.

BAGS

532

### GOPIX DETAILS

- ◆ All Gopix bags are manufactured with a 600D Polyester fabric over a PVC sponge backing. A unique double dying process gives the fabric a contrasting two-tone appearance.
- ◆ Laminated in black metal, snap hooks and D-rings are completely rust-free. Buckles are made from flexible nylon to avoid breakage and ensure smooth operation.
- ◆ All exterior sliders are designed with a smooth reverse closure system that creates an external and internal water resistant zip-per cover
- ◆ Mesh side and internal pockets
- ◆ Well positioned straps and handles make holding a Gopix bag comfortable and practical
- ◆ Large, coordinated fabric covered zipper tabs are easy to use and comfortable to hold.
- ◆ Easy close, easy open grip tabs. Clasp the tab with the thumb and forefinger of one hand and with the other pull the zipper. A simple, neat idea that really works.
- ◆ Flexible to suit your gear. Many Gopix bags feature removable velcro padded dividers. Position the dividers anywhere to suit the contents.



Gopix 10



Gopix 15



Gopix 20



Gopix 25

|                  |        | Gopix 10  | Gopix 15  | Gopix 20  | Gopix 25  | Gopix 30  | Gopix 40  | Gopix 55  | Gopix 60  | Gopix 70  | Gopix 75  |
|------------------|--------|-----------|-----------|-----------|-----------|-----------|-----------|-----------|-----------|-----------|-----------|
| Internal         | Length | 4"        | 2"        | 6"        | 3"        | 6"        | 6"        | 8"        | 6"        | 8"        | 8"        |
|                  | Height | 3"        | 4"        | 4"        | 5"        | 6"        | 4"        | 4"        | 6"        | 6"        | 6"        |
|                  | Depth  | 1"        | 2"        | 3"        | 1"        | 3"        | 2"        | 2"        | 4"        | 4"        | 4"        |
| External         | Length | 5"        | 2"        | 7"        | 3"        | 6"        | 6"        | 9"        | 7"        | 9"        | 8"        |
|                  | Height | 4"        | 5"        | 5"        | 6"        | 6"        | 5"        | 5"        | 8"        | 6"        | 6"        |
|                  | Depth  | 2"        | 2"        | 3"        | 2"        | 3"        | 3"        | 3"        | 4"        | 5"        | 5"        |
| Weight (lbs)     |        | 1/4       | 1/2       | 1/2       | 1/2       | 3/4       | 3/4       | 3/4       | 1         | 1         | 1         |
| Black/Red        |        | DLPIX10BR | DLPIX15BR | DLPIX20BR | DLPIX25BR | DLPIX30BR | DLPIX40BR | DLPIX55BR | DLPIX60BR | DLPIX70BR | DLPIX75BR |
|                  |        | 11.95     | 13.95     | 16.95     | 16.95     | 19.95     | 19.95     | 21.95     | 23.95     | 29.95     | 29.95     |
| Slate Green/Blue |        | DLPIX10GB | DLPIX15GB | DLPIX20GB | DLPIX25GB | DLPIX30GB | DLPIX40GB | DLPIX55GB | DLPIX60GB | DLPIX70GB | DLPIX75GB |
|                  |        | 11.95     | 13.95     | 16.95     | 16.95     | 19.95     | 19.95     | 21.95     | 23.95     | 29.95     | 29.95     |
| Black/Gray       |        | DLPIX10BG | DLPIX15BG | DLPIX20BG | DLPIX25BG | DLPIX30BG | DLPIX40BG | DLPIX55BG | DLPIX60BG | DLPIX70BG | DLPIX75BG |
|                  |        | 11.95     | 13.95     | 16.95     | 16.95     | 19.95     | 19.95     | 21.95     | 23.95     | 29.95     | 29.95     |



Gopix 30



Gopix 50



Gopix 60



Gopix 75



EQUIPMENT LEASING AVAILABLE

# DELSEY

## GOPIX DAYPACKS

**Gopix Small Daypack 80:** This small daypack can be carried on your shoulders with the adjustable harness or held by the padded hand grip. It has a main compartment for all your camera gear, a front organizer section for additional accessories and two side mesh pockets. It can hold an SLR with an attached 80-200mm f/2.8 lens plus additional lenses, extra body flash, light meter, digital still or video camera, or a compact camcorder with accessories in the main compartment. The front organizer section can hold additional accessories such as a PDA, cell phone, etc, and the two side mesh pockets can carry a water bottle, map, etc. Its internal dimensions are 9 1/4 x 10 1/4 x 3 3/4"; its external dimensions are 9 1/4 x 11 1/4 x 6", and it weighs 1 1/2 lbs.

**Daypack 80 (DEG80BR)** Black/Red.....**39.95**     **Daypack 80 (DEG80GB)** Green/Blue.....**39.95**     **Daypack 80 (DEG80BG)** Black/Grey .....**39.95**

**Gopix Medium Daypack 85:** Same as the Daypack 80, but slightly larger. Internal dimensions are 11 1/4 x 13 x 4 1/4". External dimensions are 12 1/4 x 13 3/4 x 4 3/4" (LHD). It weighs 2 1/2 lbs.

**Daypack 855 (DEG85BR)** Black/Red.....**43.95**     **Daypack 85 (DEG85GB)** Green/Blue.....**43.95**     **Daypack 85 (DEG85BG)** Black/Grey .....**43.95**

**Gopix 90 Backpack:** Internal dimensions are 11 x 14 1/2 x 7". External dimensions are 12 1/4 x 15 1/4 x 8 3/4" (LHD). It weighs 2 lbs.

**Daypack 90 (DEG90BR)** Black/Red.....**49.50**     **Daypack 90 (DEG90GL)** Green/Blue.....**49.50**     **Daypack 90 (DEG90BG)** Black/Grey .....**49.50**

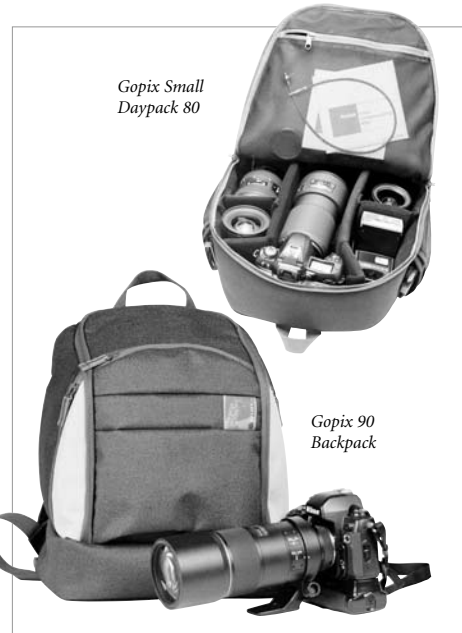

**BAGS**

**533**

### GOPIX COLLECTION FEATURES

|                                      | GOPIX 10 | GOPIX 15 | GOPIX 20 | GOPIX 25 | GOPIX 30 | GOPIX 40 | GOPIX 55 | GOPIX 60 | GOPIX 70 | GOPIX 75 | GOPIX SMALL DAYPACK 80 | GOPIX MEDIUM DAYPACK 85 | GOPIX 90 BACKPACK |
|--------------------------------------|----------|----------|----------|----------|----------|----------|----------|----------|----------|----------|------------------------|-------------------------|-------------------|
| Camera Case                          | •        | •        | •        | •        | •        | •        | •        | •        | •        | •        | •                      | •                       | •                 |
| Digital Camera Case                  | •        | •        | •        | •        | •        | •        | •        | •        | •        | •        | •                      | •                       | •                 |
| Video Case                           | •        | •        | •        | •        | •        | •        | •        | •        | •        | •        | •                      | •                       | •                 |
| Binocular Case                       | •        | •        | •        | •        | •        | •        | •        | •        | •        | •        | •                      | •                       | •                 |
| Computer Case                        |          |          |          |          |          |          |          |          |          |          |                        |                         | •                 |
| SLR Camera                           |          |          |          |          |          |          | •        | •        | •        | •        | •                      | •                       | •                 |
| Standard Lens                        |          |          |          |          |          |          |          | •        | •        | •        | •                      | •                       | •                 |
| Wide Angle Short Zoom                |          |          |          |          |          |          |          |          |          |          | •                      | •                       | •                 |
| Tele Lens                            |          |          |          |          |          |          |          |          |          |          | •                      | •                       | •                 |
| Flash                                |          |          |          |          |          |          |          | •        | •        | •        | •                      | •                       | •                 |
| Light Meter                          |          |          |          |          |          |          |          |          | •        | •        | •                      | •                       | •                 |
| Dividers                             | •        | •        | •        | •        | •        | •        | •        | •        | •        | •        | •                      | •                       | •                 |
| Front Organizer                      |          |          |          |          |          |          |          |          |          |          |                        | •                       | •                 |
| Carrying Handle(s)                   |          |          |          |          |          |          |          | •        | •        | •        | •                      | •                       | •                 |
| Accessory Pocket                     | •        | •        | •        | •        | •        | •        | •        | •        | •        | •        | •                      | •                       | •                 |
| Normal Shoulder Strap                | •        | •        | •        | •        | •        | •        | •        | •        | •        | •        | •                      | •                       | •                 |
| ATA Accepted Hand Luggage Dimensions | •        | •        | •        | •        | •        | •        | •        | •        | •        | •        | •                      | •                       | •                 |

**ORDER & INFO. (212) 502-6340 • FAX: (212) 239-7770 (800) 947-7008  
1-800-290-6750 • www.bhphotovideo.com**



# DOMKE

## CLASSIC COLLECTION

BAGS

534

Domke bags allow you to get at your equipment instantly and simply. The Classic family of bags are made from water-resistant heavyweight cotton canvas and have simple flaps, simple hardware and no clutter. They are a purist's delight, and the favorite of photojournalists around the world. Classic Domke Bags are available in black, navy, or sand canvas. Most Classic bags feature the patented padded insert system, which organizes and protects your gear with less fuss... and a lot less bulk. Interchangeable, compartmentalized inserts let you custom-tailor your Domke bag to suit any application or equipment combination. And unlike the flat walls, hatches, floors and bridges you find in other bags, these inserts are complete, self-contained storage components. Which means you can move — or remove — any Domke insert without having to empty it first!

### F-2 Original Domke Shoulder Bag

The bag that started it all. Ideal for 2 cameras with or without motor drives, 6-10 lenses up to 300mm, flash unit, 10-20 rolls of film, and accessories. It has 12 compartments and pockets, a 4-compartment padded insert, an adjustable non-slip Gripper Strap that runs completely around the bag, a removable padded bottom stiffener, and a removable hand carrying strap. The main compartment is 12 x 6.5 x 9" (LWD), and it weighs 2 lbs. 9 oz.

|                                 |                                 |                                 |
|---------------------------------|---------------------------------|---------------------------------|
| <b>F-2 Shoulder Bag (DOF2B)</b> | <b>F-2 Shoulder Bag (DOF2N)</b> | <b>F-2 Shoulder Bag (DOF2S)</b> |
| Black color .....109.97         | Navy color .....109.97          | Sand color .....109.97          |

**F-2 Ballistic Shoulder Bag (DOF2BB):** Same as above, but made from black ballistic nylon.109.97



### F-1X Little Bit Bigger Shoulder Bag

Just "a little bit bigger" than the F-2. It holds 3 complete 35mm camera systems with or without motor drives, 9-13 lenses, 2 strobes, battery pack, small tripod, umbrella, film, and accessories. It has even gained popularity among TV crews as a "run" bag. It has 15 compartments and pockets, a patented four-compartment padded insert, and 4 pockets to organize small items. Dimensions are 17 x 6.7 x 9" (LWD). It weighs 3 lbs. 4 oz.

|                          |                          |                          |
|--------------------------|--------------------------|--------------------------|
| <b>F-1X Bag (DOF1XB)</b> | <b>F-1X Bag (DOF1XN)</b> | <b>F-1X Bag (DOF1XS)</b> |
| Black color .....134.97  | Navy color .....134.97   | Sand color .....134.97   |

**F-1X Ballistic Shoulder Bag (DOF1XBB)**  
Same as above, but made from black ballistic nylon .....147.97

### F-3X Super Compact Shoulder Bag

The bag to grab when the assignment doesn't call for dozens of pieces of equipment. The F-3X is a very inconspicuous camera bag that carries a surprising amount of gear. Ideal for 1 or 2 cameras with or without motor drives, 3-4 lenses, flash unit, film, and accessories. It has nine compartments and pockets, Domke's trademark "upside-down" zipper pouch, a removable padded partition wall and a removable hand carrying strap. Dimensions are 8.5 x 5.5 x 9" (LWD). Weighs 2 lbs.

|                          |                          |                          |
|--------------------------|--------------------------|--------------------------|
| <b>F-3X Bag (DOF3XB)</b> | <b>F-3X Bag (DOF3XN)</b> | <b>F-3X Bag (DOF3XS)</b> |
| Black color .....98.97   | Navy color .....98.97    | Sand color .....98.97    |

**F-3X Ballistic Shoulder Bag (DOF3XBB):** Same as above, but made from black ballistic nylon .....98.97



### F-4AF Pro System

Today's professional autofocus SLR bodies are larger than ever. Add a state-of-the-art zoom lens, and you've got a formidable piece of equipment. The F-4AF offers eight compartments and pockets, a large padded insert that holds an autofocus SLR/zoom lens in a "grab-and shoot" position, and a second insert that has twin compartments for extra lenses or "potato masher" strobes. It is ideal for the Nikon F-4/F-5 or Canon EOS-1 with zoom lens mounted, two additional zoom lenses, flash, film, accessories. It features an adjustable non-slip Gripper Strap, an open cell foam liner sewn into bottom and a hand carrying strap. Dimensions are 9 x 8 x 11" (LWD); it weighs 2 lb. 7 oz.

|                           |                           |                           |
|---------------------------|---------------------------|---------------------------|
| <b>F-3X Bag (DOF4AFB)</b> | <b>F-3X Bag (DOF4AFN)</b> | <b>F-3X Bag (DOF4AFS)</b> |
| Black color .....109.97   | Navy color .....109.97    | Sand color .....109.97    |



# DOMKE

## CLASSIC COLLECTION



### F-5XB Shoulder/Belt Bag

Use this versatile hip-hugger as a camera bag or remove the included shoulder strap and thread your belt through the tunnel for an instant waist pack. Ideal for 1 SLR or rangefinder camera, 1 or 2 lenses, filters, film and accessories. It has 7 compartments and pockets, a padded main compartment lined with Velcro compatible material with two removable padded divider walls. A heavy-duty zipper closes the main compartment, and double pull tabs regulate the size and location of openings. All compartments are protected by oversized weather flaps. 10.5 x 4.5 x 6.5" main compartment, it weighs 1 lb. 5 oz.

|  |  |   |
|--|--|---|
| <b>F-5XB Bag (DOF5XBB)</b><br>Black color .....54.97 | <b>F-5XB Bag (DOF5XBN)</b><br>Navy color.....54.97 | <b>F-5XB Bag (DOF5XBS)</b><br>Sand color .....54.97 |
|--|--|---|

### F-6 Little Bit Smaller Shoulder Bag

An exceptionally discreet bag with a low profile exterior. Similar to the F-2, it is scaled down to accommodate a little less equipment. It has room for 1 or 2 cameras with or without motor drives, 3-4 lenses, flash unit, film and accessories. It's nine compartments and pockets include two full-length zippered pockets, and a padded four compartment "short" insert. A lockable double-pull zipper regulates the size and location of cargo compartment openings. Its main compartment is 12 x 6 x 7" (LWD); it weighs 1 lb. 14 oz.



|   |   |   |
|---|---|---|
| <b>F-6 Bag (DOF6B)</b><br>Black color.....74.97 | <b>F-6 Bag (DOF6N)</b><br>Navy color .....74.97 | <b>F-6 Bag (DOF6S)</b><br>Sand color .....74.97 |
|---|---|---|

**F-6 Ballistic Shoulder Bag (DOF6BB):** Same as above, but made from black ballistic nylon...74.97



### F-7 Double AF Shoulder Bag

Built to carry two complete professional SLR's with motor drives and zooms attached, 2 or more additional lenses, flash, film, and accessories. An included adjustable belt system works with the Gripper Strap to keep even a fully-loaded F-7 snug against your hip. It features 14 compartments and pockets, 3 padded inserts (which include 2 large single-compartments for cameras, and a 2-compartment for extra lenses), an adjustable Gripper Strap, double-tracked bottom for added support, a removable padded floor support, 4-point suspension carrying handle and 3 see-through mesh accessory pockets. 14 x 7 x 11" (LWD); it weighs 4 lb. 5 oz.

|   |   |
|---|---|
| <b>F-7 Bag (DOF7B):</b> Black color .....145.97 | <b>F-7 Bag (DOF7S):</b> Sand color.....145.97 |
|---|---|

## THE JOURNALIST SERIES

*Designed for the ever-changing tools and demands of photography. From bigger, "faster" autofocus zooms to digital cameras, these Ballistic Nylon bags deliver a distinctive range of features. J-Series bags come complete with fitted weather flaps, a special, adjustable Padded Insert System, and larger end pockets with their own separate Padded Inserts.*

**The J-1 Bag (DOJ1B):** Ideal for 2 camera bodies with motor drives, 4-6 autofocus lenses, flash, meter, film and accessories. It handles longer lenses and lens hoods, and allows cameras to be carried vertically with lens mounted. It has 14 pockets and compartments, including two large front pockets and two pen/flashlight pockets, a deluxe hand strap with leather grip and a Gripper shoulder strap. 14 x 6.5 x 11. It weighs 4 lb. 2 oz .....139.97

**The J-2 Bag (DOJ2B):** Similar to the J-1 Bag, but a bit smaller. Its dimensions are 12 x 6.5 x 9", and it weighs 3 lb. 13 oz.....129.97



**The J-3 Bag (DOJ3B):** A super compact bag, it includes nine compartments and pockets. The main compartment is lined with a heavyweight Velcro loop and includes two movable/removable padded divider walls. It includes a removable hand carry strap, front and back external pockets and rubber feet to reduce wear. Holds 1 or 2 cameras with or without motor drives, 3-4 lenses, flash, film and accessories. Dimensions are 9 x 7 x 9", it weighs 2 lb. 11 oz.....109.97

BAGS

535

# DOMKE

## CLASSIC COLLECTION

BAGS

536

### F-802 Reporters Satchel

With its flexible main compartment, enormous cargo pockets and zippered pouches, the F-802 is a briefcase, camera bag, laptop bag and more. It features seven compartments and pockets, including two expanding cargo pockets with individual weather flaps; padded side walls and bottom, rigid top panel; reinforced handle is box-stitched to top of bag; adjustable Gripper Shoulder Strap is sewn completely around the Satchel for support. The main compartment interior dimensions are 15.5 x 4 x 12" LWD, and its weight is 2.5 lbs.



|  |   |   |
|--|---|---|
| <b>F-802 Satchel (DOF802B)</b><br>Black color ..... <b>64.95</b> | <b>F-802 Satchel (DOF802N)</b><br>Navy color ..... <b>64.95</b> | <b>F-802 Satchel (DOF802S)</b><br>Sand color ..... <b>64.95</b> |
|--|---|---|



### F-803 Camera Satchel

For those who don't want to call attention to their equipment. Ideal for 2 or 3 cameras, 1 or 2 extra lenses and accessories. It has 8 compartments and pockets; includes a movable padded insert; full-length Velcro strips in main compartment accept additional optional inserts; padded side walls and bottom; adjustable Gripper Shoulder Strap runs completely around the

Satchel. Main compartment interior dimensions are 13 x 4 x 9", it weighs 1.9 lbs.

|  |   |   |
|--|---|---|
| <b>F-803 Satchel (DOF803B)</b><br>Black color ..... <b>84.95</b> | <b>F-803 Satchel (DOF803N)</b><br>Navy color ..... <b>84.95</b> | <b>F-803 Satchel (DOF803S)</b><br>Sand color ..... <b>84.95</b> |
|--|---|---|

### J-803 Camera Satchel (DOJ803)

The first J-Series satchel designed to carry cameras, laptops, and electronic organizers. It has 11 compartments and pockets, plus a padded insert, a large front pocket for a laptop or files, 2 Velcro-flap front pockets for camera bodies, lenses or flash, and a large weather flap with 3 zippered pockets. A detachable, non-slip shoulder strap and leather-grip hand strap is included. 13.5 x 4.5 x 10" (LWD); it weighs 2 lbs. 3 oz .....**90.05**



### J-Series Long Lens Bag

Vertical black canvas bags hold high speed telephoto lenses with 2" Gripper style shoulder strap and loops on side for attaching monopods. They feature a special flap with a 45° zip that opens away from the photographer, permitting a good grip on lens; bag is fully padded for protection and holds its shape when empty, making it easy to fit lens into empty bag after use; hangs vertically on shoulder; front pocket holds brick of film; flat rear pocket holds note pads.



|  |
|--|
| <b>J-300 Long Lens Bag (DOJ300):</b> For 300mm f/2.8 lens. 7 x 8 x 12" ..... <b>97.50</b>  |
| <b>J-400 Long Lens Bag (DOJ400):</b> For 400mm f/2.8 lens. 7 x 8 x 18" ..... <b>103.95</b> |
| <b>J-600 Long Lens Bag (DOJ600):</b> For 600mm f/4 lens. 7 x 8 x 22" ..... <b>109.95</b>   |

### PhoTOGS Jacket

If you're outdoors shooting, hiking, birding or touring, the PhoTOGS Jacket/Vest has 16 pockets to keep your gear easily accessible. There's plenty of room for cameras, lenses, flash, filters, binoculars, maps, and just about anything else you want to "wear." It features zip-off sleeves that allow you to convert the jacket to a vest, a stowaway nylon hood, two hidden zippered pockets for passports, tickets, cash, etc. and roomy, bellows-style cargo pockets. 100% cotton, neutral khaki with an olive/gray tint.



**Small (DOJPS), Medium (DOJPM), Large (DOJPM), X-Large (DOJPL) .....109.95**  
**XX-Large (DOJXXL):** 54-56 chest.....**119.95**

PhoTOGS Jacket and Vest sizes:  
Small: 36-38 chest; Medium: 40-44;  
Large: 44-48; X-Large: 50-52;  
XX-Large 54-56 chest

### PhoTOGS Vest



The ultimate combination of fashion and function for the active photographer or outdoor enthusiast. The PhoTOGS Vest is made from 100% cotton, pigment-dyed Khaki

color. A hint of olive/gray makes this vest a handsome, neutral-tone garment.

- ◆ Cotton mesh panels at yoke and back provide cooling ventilation.
- ◆ Pockets, pockets, everywhere: cargo, handwarmer and zippered. (18 in all!)
- ◆ Shoulders are padded and quilted.
- ◆ Heavy-duty double-pull zipper for greater comfort.

**Small (DOVPS), Medium (DOVPM), Large (DOVPL), X-Large (DOVPL) .....64.95**  
**XX-Large (DOVXXL) .....71.50**



# DOMKE

## ADD-ON POUCHES

**F-901 Compact Pouch:** Great for small zoom lenses, flash units, or cell phones. Adjustable Velcro tabs attach securely to shoulder straps, or you can use the extra-wide belt loop. The top flap has a Velcro closure. The F-901 accepts an optional FA-280 Mini Insert. It's dimensions are 9 x 5 x 3".

**F-901 Pouch (DOF901B)** Black color.....**16.95**     **F-901 Pouch (DOF901N)** Navy color.....**16.95**     **F-901 Pouch (DOF901S)** Sand color.....**16.95**

**F-902 Super Pouch:** A handy holster for handle-type strobes, power packs or a 300mm f/4 lens. Attach with either extra-wide belt loop or adjustable Velcro straps. Dimensions are 11 x 6 x 3".

**F-902 Pouch (DOF902B)** Black color.....**16.95**     **F-902 Pouch (DOF902N)** Navy color.....**16.95**

**F-945 Belt Pouch:** Great for 4 x 5" film holders or battery packs. Designed specifically for belt use, the F-945 does not have Velcro tabs found on other models. It's dimensions are 6 x 7 x 2".

**F-945 Pouch (DOF945B)** Black color.....**16.95**     **F-945 Pouch (DOF945N)** Navy color.....**16.95**     **F-945 Pouch (DOF945S)** Sand color.....**16.95**



BAGS

## PADDED INSERT SYSTEM

Domke's exclusive, patented design prevents small items from wandering between compartments, and allows you to pre-load and store Inserts outside the Domke Bag. Preparing for a shoot is as easy as dropping in the Insert(s) you need! All Inserts feature removable outer-wall cushions so you can increase or reduce the padding around your equipment.

**1-Compartment Small Insert (DOFA280)**  
Included with the F-803. Holds one lens, flash, or standard camera. 4 x 3 x 8" ..**12.95**

**1-Compartment Insert (DOFA210)**  
For a larger camera body or a standard body with a lens attached, 2 flash units or a zoom lens. 6 x 3 x 8" .....**13.95**

**1-Compartment Large Insert (DOFA211)**  
Included with F-4AF and F-7 Bags. Designed for a large autofocus camera with a zoom mount, or a medium format camera. 5 x 6 x 8" .....**16.95**

**2 Compartment Insert (DOFA220)**  
Included with F-4AF and F-7 Bags. For 2 lenses, 2 flash units, spare camera bodies, or any similar combination. Add this insert to your F-2 Bag insert to section it off completely. 6 x 3 x 8" ..**17.95**

**3 Compartment Insert (DOFA230)**  
Use in your Satchel to carry a camera, lens, and flash safely. 11 x 3 x 8" .....**18.95**

**3 Compartment Insert (DOFA233)**  
Built to hold a camera body with lens attached, plus two extra lenses or flash units. 7 x 6 x 8" .....**18.95**

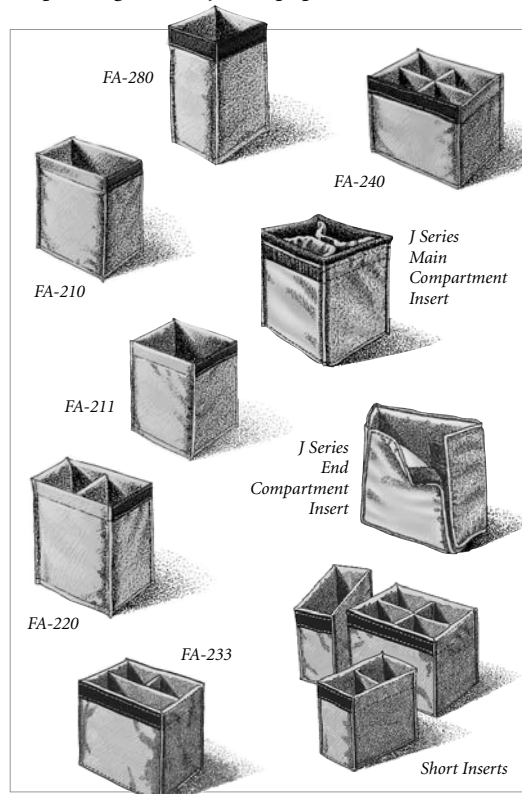

**4 Compartment Insert (DOFA240)**  
Included with the F-2 and F-1X bags. Designed for extra lenses and/or strobe units, spare camera bodies, or accessories. 7 x 6 x 8" .....**19.95**

**J Series Main Compartment Insert (DOIMCJ)**  
Included with J-1 and J-2 bag. The adjustable main compartment is lined with heavyweight Velcro loop, and its two flexible, padded divider walls can be arranged to fit different camera bodies and lenses. 7.5 x 6 x 8" ....**20.95**

**J Series End Compartment Insert (DOIEPJS)**  
Two are included with each J-1, J-2, and J-3 bag. They carry a flash meter, cell phone or even an extra small lens. Dimensions are 7 x 3 x 7" .....**12.95**

**Short Inserts for F-6**  
Same as the regular sized inserts, but only 6.75" height to fit the F-6 bag.  
**1 Compartment (DOFA246)**.....**18.95**  
**2 Compartment (DOFA226)**.....**16.95**  
**4 Compartment (DOFA216)**.....**12.95**

537

# DOMKE

## ACCESSORIES

BAGS

538

### FilmGuard

Designed to protect unprocessed film and other sensitive media from low-dosage x-rays machines used in airport security and customs checks. (Use FilmGuard in carry-on luggage, because checked luggage is exposed to high-dosage x-rays that even FilmGuard cannot protect against.) FilmGuard offers triple-layer construction that also keeps dust and moisture out: lead-impregnated vinyl sheet sandwiched between an outer shell of Ballistic Nylon and interior lining of smooth Nylon. Available in Black color.



**Mini-Small FilmGuard (DOFGM):** Holds nine 35mm film cassettes or a small camera. 5.25 x 8" .....**11.95**

**Small FilmGuard (DOFGS):** Holds 15 rolls of 35mm film or a small camera with a few rolls of film. 9.5 x 8" .....**16.95**

**Large FilmGuard (DOFGL):** Holds 35 rolls of 35mm film, or three 50-sheet boxes of 4 x 5" film, or a small camera with a few rolls of film. 10.5 x 12" .....**24.95**

### Color-Coded Protective Wraps

These versatile problem-solvers are made of padded, Velcro-compatible knit with a non-scratch nylon backing. They wrap around a camera, lenses or anything that needs protection. Velcro tabs on all four corners let each wrap be self-secured in any number of ways. Available in Black, Red, Gray, or Yellow.

**11" Protective Wrap (DOPW11)** .....**9.95**

**15" Protective Wrap (DOPW15)** .....**10.95**

**19" Protective Wrap (DOPW19)** .....**12.95**

**FA-100 Backpack Strap (DOSBP):** This unique harness attaches to your Domke Bag or Satchel, and allows it to ride low on your back like a backpack.....**16.95**

**Post Office-Style Shoulder Pad (DOSP):** An ergonomical pad made of thick foam rubber on tough leather backing. Identical to the shoulder pad used by letter carriers, with the addition of Velcro tabs which adjust to fit straps up to 2.75" wide.....**12.95**

**Super Handle:** Made of tough canvas webbing, with a rigid grip insert for leverage and comfort. Standard on the F-804, it attaches to the F-2, F-3X, F-4AF, and F-6 bags. Available in Black (DOSHB), and Tan (DOSHT) colors .....**8.95**

### Deluxe Bottom Boards

**For F-1X (DOBBF1X)** .....**8.95**

**For F-2 and J-2 (DOBBF2)** .....**8.95**

**For J-1 (DOBBJ1)**.....**9.95**

**Handle for J-Series Bags (DOHJS)** .....**8.95**

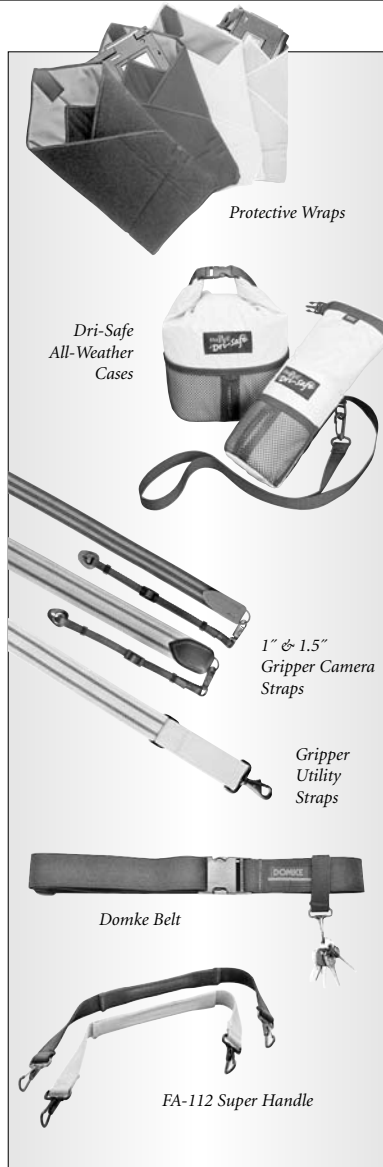

### Dri-Safe All-Weather Cases

A waterproof liner between the pack-cloth outside and ripstop nylon inside, coupled with a roll-top closure, cushions and protects the contents. Rear loops allow attachment to your belt or another bag. They are available in 2 sizes:

**Small Dri-Safe:** 7 x 3.75 x 2.5". Available in Black (DODSSB) and Yellow (DODSSY) .....**26.21**

**Small Dri-Safe:** 7 x 7.5 x 3.25". Available in Black (DODSLB) and Yellow (DODSLY) .....**32.21**

**Gripper Utility Strap:** Made of the same thick webbing used on all Domke Bags, with Gripper non-slip tracks woven in. This adjustable strap is 1.5" wide, and has durable nylon swivel hooks at both ends. Great for carrying hard cases and sling bags, or as a supplementary waist strap. Available in Black (DOSG1.5B) and Tan (DOSG1.5T) color .....**9.95**

**2" Replacement Gripper Bag Strap:** Available in Black (DOSGB) and Tan (DOSGT) color .....**6.95**

**1" Gripper Camera Strap:** Non-slip security for the times you need to carry your camera outside your bag. It attaches to any SLR. Available in Black (DOSG1B), Navy (DOSG1N), and Tan (DOSG1T) colors .....**12.95**

**1" Gripper Strap with Swivel QR:** Same as above, with twist-proof quick release extensions. Available in Black (DOSGS1B), Navy (DOSGS1N), and Tan (DOSGS1T).....**12.95**

**1.5" Gripper Strap with Swivel QR:** Available in Black (DOSGS1.5B), Navy (DOSGS1.5N), and Tan (DOSGS1.5T).**16.95**

### Domke Belts

Perfect for your F-5XB Bag or Accessory Pouch. Made of tough 2" wide canvas webbing with durable side-release buckle and removable key/accessory clip.

**Regular 42" Belt:** Available in Black (DOBRF5XBB) and Tan (DOBRF5XBT). Replacement for F-7 bag.....**16.95**

**Large 52" Belt:** Available in Black (DOBLF5XBB) and Tan (DOBLF5XBT) .....**16.95**



**ONE HOUR FREE PARKING**  
AT 349 W. 34th STREET (with purchase of \$100 or more)



## CASES & BACKPACKS

### LOCATION CASES



FC 4x5  
Monorail  
Case

TRP  
Tripod Bag

LSB Light Stand Bag

**FC 4x5 Monorail Case (F6FC4X5B):** This semi-rigid case is designed to carry 4 x 5" view cameras, but can also accommodate film backs, meters and accessories. Adjustable interior support dividers allow you to customize the camera placement. Zippered closure with 4 buckles provide extra protection. The rigid carry handle is covered with soft neoprene for comfort. Interior dimensions: 21 x 15 x 10.5". Black color.....**181.95**

**FC 4x5 Monorail Case (F6FC4X5G):** Same as above in gray.....**181.95**

**TRP Tripod Bag (F6TRP):** Carries most tripods without detaching the heads or handles. A zippered exterior pocket holds smaller accessories. Carry it either by its detachable shoulder strap or with the wraparound leather carrying handle. It's interior dimensions are 9.5 x 9.5 x 41". Available in black only .....**32.95**

**LSB Light Stand Bag (F6LSB):** Designed to carry light stands, the LSB offers a roomy internal pocket that will hold umbrellas while two zippered pockets on the ends hold accessories. Carry it either by its detachable shoulder strap or the wraparound leather carrying handle. Interior dimensions: 7 x 7 x 36". Available in black only .....**35.95**

### BACKPACKS

Carry heavy loads comfortably for long periods of time with the backpack's ergonomically designed shoulder straps with sternum and waist belts.

**BPX Extra Large Backpack (F6BPXB):** Handles formats up to 8 x 10". The main body has two compartments and comes with two FH 4x5" detachable film pouches. The BPX features a hide-away rain cover, removable dividers, extra lumbar support, a lash down tab to attach a tripod, and 16 attachment loops to hold accessory pockets. 23 x 14 x 6". Black color.....**209.95**

**BPX Extra Large Backpack (F6BPXG):** Same as above in gray.....**209.95**

**BPR Medium Backpack (F6BPRB):** The top compartment is designed to carry SLR equipment. The lower clamshell opening has a large compartment with dividers. Four additional pockets hold miscellaneous accessories. A neoprene carry handle lets you lift and carry. 13 x 17 x 6". Black color .....**97.50**

|  |   |   |
|--|---|---|
| <b>BPR Medium Backpack (F6BPRG):</b><br>Same as above in gray ... <b>97.50</b> | <b>BPR Medium Backpack (F6BPRN):</b><br>Same as above in navy... <b>97.50</b> | <b>BPR Medium Backpack (F6BPRS):</b><br>Same as above in spruce .. <b>97.50</b> |
|--|---|---|

**BP Large Backpack (F6BPB):** Holds 4x5" or 8x10" film holders in its large front pocket. A padded flap separates camera equipment from interior mesh pockets, and removable dividers allow you to customize the interior to your specific needs. A neoprene top handle lets you lift and carry. Unique lash down tabs allow you to attach a tripod, and 16 loops can hold accessory pockets. 13 x 16 x 6". Black color .....**142.95**

**BP Large Backpack (F6BPG):** Same as above in gray.....**142.95**



BPX  
Backpack

BPR  
Backpack

BP  
Backpack

### UNIVERSAL ACCESSORIES

**AB Accessory Belt - Black (F6AB)**  
A 1.5" wide black accessible waist belt with quick release .....**9.50**

**LSP Leather Pad - Black (F6LSP)**  
Suede covered 2.5 x 8.5" strap provides comfort when carrying heavy loads .....**12.95**



## SHOULDER PACKS & BAGS

### Shoulder Packs

When hanging from your shoulder, these shoulder packs are designed to open away from your body for easy access to contents. A front organizing panel and mesh exterior side pockets provide quick access to small items while working. Hydro seal zipper design protects your equipment.



**SU Small Shoulder Pack:** Holds a 35mm SLR, 2 lenses, a flash and accessories. 9 x 6.5 x 4". The SU Shoulder Pack keeps all of your equipment in plain view.

- SU Pack (F6SUB): Black color .....38.50
- SU Pack (F6SUN): Navy color .....38.50
- SU Pack (F6SUG): Gray color.....38.50
- SU Pack (F6SUGR): Green color.....38.50
- SU Pack (F6SUS): Spruce color .....38.50

**SG Large Shoulder Pack:** Holds a 35mm SLR with an attached lens, an extra lens, a flash and accessories. 9 x 6.5 x 8" interior. Hide-away strap converts the SG to a waist-pack.

- SG Bag (F6SGB) Black color .....49.95
- SG Bag (F6SGN): Navy color .....49.95
- SG Bag (F6SGG): Gray color.....49.95
- SG Bag (F6SGGR): Green color .....49.95
- SG Bag (F6SGS): Spruce color .....49.95

## SHOULDER BAG SYSTEMS

System bags feature hydro seal protection flaps behind and above the zippers on both the main compartment and the side pockets for extra protection. Two fully padded detachable side pockets hold plenty of film or accessories. Using an optional accessory waist belt, you can conveniently wear either the main case with or without its attached pockets, or just the detached side pockets. When hanging from the shoulder, the lid opens away from the body for easy accessibility. An ergonomically designed padded shoulder strap is included.

**SC Medium 35mm System:** The SC accommodates a camera body with attached lens, two extra lenses and a portable flash. Interior dimensions: 10.5 x 8 x 6.5".

- SC System (F6SCB): Black.....74.95
- SC System (F6SCG): Gray .....74.95
- SC System (F6SCN): Navy.....74.95
- SC System (F6SCGR): Green .....74.95
- SC System (F6SCS): Spruce color.....74.95

**SCM Large 35mm System:** A full two inches longer than the SC, the SCM also accommodates a camera body with attached lens, an extra camera body, extra lenses and a portable flash. Interior dimensions: 12.5 x 8 x 6.5".

- SCM System (F6SCMB): Black.....99.95
- SCM System (F6SCMG): Gray.....99.95
- SCM System (F6SCMN): Navy.....99.95
- SCM System (F6SCMGR): Green...99.95
- SCM System (F6SCMS): Spruce color .....99.95

**MFX Medium Format System:** Removable dividers let you customize the main compartment, making it perfect for medium format equipment. It will hold two camera bodies, several lenses, a meter, filters, film and accessories. A detachable interior pocket holds two bricks of film. Interior dimensions: 15 x 9 x 7".

- MFX System (F6MEXB): Black.....142.95
- MFX System (F6MEXG): Gray .....142.95
- MFX System (F6MEXBL): Navy ...142.95
- MFX System (F6MEXS): Spruce...142.95

**SCX Extra Large 35mm System:** This comprehensive case satisfies even the most demanding professional. It holds two camera bodies with attached lenses, additional lenses, meters, filters and a portable flash. Twin drop-down front organizers keep small items within easy reach. The detachable interior pocket holds a brick of film and is easily removed when passing through airport security. Interior dimensions: 15 x 9 x 7".

- SCX System (F6SCXB): Black.....139.95
- SCX System (F6SCXG): Gray .....139.95
- SCX System (F6SCXN): Navy.....139.95
- SCX System (F6SCXGR): Green ...139.95
- SCX System (F6SCXS): Spruce color.....139.95



## SHOULDER BAG SYSTEM ACCESSORIES

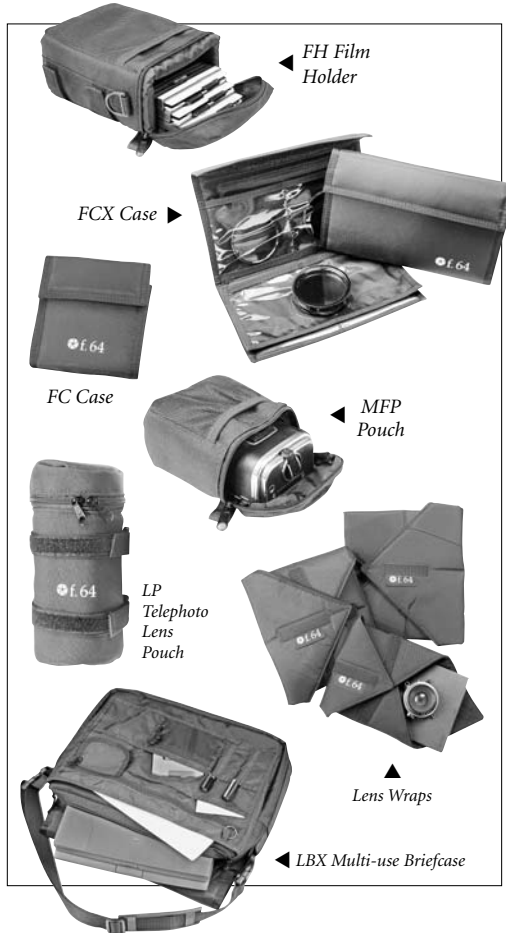

**FH 4x5 Film Holder (F6CFH45):** Carries and protects up to six 4x5 film holders. A mesh pocket on the front provides convenient storage for dark slides or small accessories. Half inch padding provides extra protection for sensitive equipment. Four mounting straps allow you to attach the Film Holder to the SC, SCM and SCX camera bags, and BP and BPX backpacks. 3.5 x 5.5 x 8.5". Available in black only .....**27.50**

**FCX Large Multi-use Case (F6FCX):** The FCX has eight pockets designed to protect and organize filters up to 3.75 x 3.75" or floppy and zip disks. Wear it on your waist or fit it into most camera bags. Closed dimensions: 5.5 x 9.5". Available in black only .....**17.50**

**FC Multi-use Case (F6FC):** Similar to the FCX, but a bit smaller with only four pockets. Closed dimensions: 5.5 x 5". Available in black only .....**9.95**

**MFP Medium Format Pouch:** Provides quick access to medium format camera backs. A front mesh pocket adds storage for dark slides and film. When hanging from the shoulder, the lid opens away from the body for easy accessibility. 2.25 x 4 x 4.25" interior. **MFP Black Pouch (F6MFPB) .....23.95**      **MFP Gray Pouch (F6MFPG) .....23.95**

**LP Telephoto Lens Pouch (F6LP):** Provides protection for zoom or telephoto lenses up to 7.5" long and 3.5" in diameter. Keep your lens available by sliding the pouch onto your camera case strap. Interior dimensions: 3.5 x 3.5 x 7". Available in black .....**17.50**

**LPX Large Telephoto Lens Pouch (F6LPX):** Same as the LP, but for lenses up to 11" long. Interior dimensions are 3.5 x 3.5 x 11" .....**23.95**

**Lens Wraps:** Lens wraps are heavily padded and provide complete protection for your large format lenses and accessories. Available in black only.  
**LW11 (F6LW11): 11" ...15.95**      **LW15 (F6LW15): 15" ...19.95**      **LW18 (F6LW18): 18" ....21.95**

**LBX Multi-use Briefcase (F6LBX):** An expandable, padded briefcase designed to carry anything from prints to a lightbox to a laptop computer. Zippered pockets provide extra space to organize accessories. Carry it by its handle or an attachable shoulder strap. Interior dimensions: 12 x 14 x 4" (6" expanded). Available in black only .....**53.50**

BAGS

541

## STRONG BOXES

**SB Strong Box:** The SB has a rigid inner shell, a durable outer skin and is sized to fit within most airline carry-on requirements. It features a flexible divider system, four zippered mesh pockets in the interior and one zippered pocket on the exterior, five rubber feet on the bottom to raise the case off the ground when set down. Carry it with the wrap-around leather handle or its padded shoulder strap. Interior dimensions: 17 x 14 x 5". Available in black (F6SBB) and gray (F6SBG) color .....**142.95**

### SBW Wheeled Strong Box

The wheels and the telescoping handle of the SBW facilitate especially smooth travel with your heavy equipment. While the handle opens to a comfortable length, double wheels on each side balance your load evenly. The SBW also has a rigid inner shell, a durable outer skin, and is sized to fit within airline carry-on size requirements. The flexible divider system allows you to customize the interior to secure whatever equipment you bring. Four zippered mesh pockets in the interior and one zippered pocket on the exterior organize your smaller items. Carry it with its wrap-around leather handle or with an ergonomically designed padded shoulder strap. Interior dimensions are 17 x 14 x 5". Available in gray (F6SBWG) color .....**187.50**

**SBX Large Strong Box:** Especially useful for carrying lighting equipment. Like the SB Strong Box, the SBX has a rigid inner shell and durable outer skin and fits within most airline carry-on bag size requirements. It also offers a flexible divider system, five zippered mesh pockets, a business card holder in the interior, two zippered pockets on the exterior, and five rubber feet. It has a wrap-around leather handle and a padded shoulder strap. Interior dimensions are 22.5 x 15 x 7". Available in black (F6SBXB) and gray (F6SBXG) .....**224.95**



# f.64

## POUCHES, HOLSTERS, WAIST PACKS

BAGS

542

f.64 photographic equipment bags are designed with a maximum of craft and imagination. Working photographers test every style of bag and consult with f.64 throughout the development process to assure that every detail is in place. They all offer the highest quality materials, reinforced and protected at all high-stress areas, high density padding to protect your delicate equipment against heat and impact, and hydro-sealed zippers to protect against the weather.

### ACTION SERIES

#### Action Pouches

For the photographer traveling light, the AS and AL are all-purpose camera bags with two zippered pockets great for digital, ELPH, and small point and shoot cameras. The smaller pocket will hold an ELPH camera, or just film and keys. The shoulder strap has both male and female buckles which can convert into a waist belt and allows the camera bag to be worn as a waist pouch.



**AS Small Action Bags:** 6.5 x 3.5 x 3" interior.

|                             |       |                              |       |
|-----------------------------|-------|------------------------------|-------|
| AS Bag (F6ASB): Black.....  | 16.95 | AS Bag (F6ASG): Gray .....   | 16.95 |
| AS Bag (F6ASN): Navy.....   | 16.95 | AS Bag (F6ASGR): Green ..... | 16.95 |
| AS Bag (F6ASS): Spruce..... | 16.95 |                              |       |

**AL Large Action Bags:** 7 x 4 x 3" interior.

|                             |       |                              |       |
|-----------------------------|-------|------------------------------|-------|
| AL Bag (F6ALB): Black ..... | 18.95 | AL Bag (F6ALG): Gray .....   | 18.95 |
| AL Bag (F6ALN): Navy.....   | 18.95 | AL Bag (F6ALGR): Green ..... | 18.95 |
| AL Bag (F6ALS): Spruce..... | 18.95 |                              |       |



#### Holster Cases

Holster cases protect a 35mm camera with a lens. Hydro seal protection flaps behind and above the zipper protect your camera from rain. An exterior zippered compartment holds small accessories. Holster Cases are available in 3 different sizes and different colors. They all come with a shoulder strap, or can be worn on a belt.

**HC Small Holster Cases:** Holds a 35mm camera with a normal focal length. Interior dimensions are 6 x 4.5 x 3.5".

|                                      |       |
|--------------------------------------|-------|
| HC Case (F6HCSB): Black color.....   | 28.50 |
| HC Case (F6HCSN): Navy color .....   | 28.50 |
| HC Case (F6HCSG): Gray color.....    | 28.50 |
| HC Case (F6AHSGR): Green color.....  | 28.50 |
| HC Case (F6HCSS): Spruce color ..... | 28.50 |

**HCM Medium Holster Cases:**

Holds a 35mm camera with a medium length zoom or telephoto lens. It's interior dimensions are 8 x 6 x 4.5".

|                                       |       |
|---------------------------------------|-------|
| HCM Case (F6HCMB): Black color .....  | 33.95 |
| HCM Case (F6HCMN): Navy color .....   | 33.95 |
| HCM Case (F6HCMG): Gray color.....    | 33.95 |
| HCM Case (F6HCMC): Spruce color ..... | 33.95 |

**HCX Large Holster Cases:** Holds a 35mm camera with a lens up to 7.5" long. Interior dimensions are 10 x 8.5 x 5"

|                                       |       |
|---------------------------------------|-------|
| HCX Case (F6HCLB): Black color.....   | 42.95 |
| HCX Case (F6HCLN): Navy color .....   | 42.95 |
| HCX Case (F6HCLG): Gray color.....    | 42.95 |
| HCX Case (F6AHCLR): Green color.....  | 42.95 |
| HCX Case (F6HCLS): Spruce color ..... | 42.95 |

#### Waist Packs

In a unique design feature, the lid of these waist packs opens away from your body to allow you the best equipment access. Mesh exterior side panels keep your contents organized. Belt stabilizers and cinch straps adjust the pack securely to your waist. A large front pocket holds smaller accessories, and the hydro seal zipper design protects your belongings from rain. A shoulder strap is also included. The waist packs are available in two sizes: The FP Waist Pack has a 10.5 x 5 x 5" interior and the FPX Large Waist Pack has a 13 x 5 x 5" interior.

**FP Waist Packs:**

|                                    |       |                                    |       |
|------------------------------------|-------|------------------------------------|-------|
| FP Pack (F6FPB): Black color ..... | 49.50 | FP Pack (F6FPG): Green color.....  | 49.50 |
| FP Pack (F6FPN): Navy color .....  | 49.50 | FP Pack (F6FPS): Spruce color..... | 49.50 |

**FPX Large Waist Packs:**

|                                       |       |                                       |       |
|---------------------------------------|-------|---------------------------------------|-------|
| FPX Pack (F6FPXB): Black color .....  | 56.50 | FPX Pack (F6FPXG): Grey color.....    | 56.50 |
| FPX Pack (F6FPXN): Navy color.....    | 56.50 | FPX Pack (F6FPXGR): Green color ..... | 56.50 |
| FPX Pack (F6FPXS): Spruce color ..... | 56.50 |                                       |       |



For Any Inquiries Regarding Your Order, Call Our Customer Service:  
(800) 221-5743 • (212) 239-7765 • FAX: (800) 947-2215 • (212) 239-7549

# HAKUBA

## AS SERIES ALUMINUM CASES

The "AS" series cases are Hakuba's most competitively priced aluminum cases, yet still have outstanding quality and functionality. Built with starburst riveting and reinforced corners for maximum strength, the "AS" series offers "AA" (Auto Aligning) lids and one-touch latches, braced hinges, hood pockets and a customizable interior. Like all Hakuba cases, the "AS" series is fully lined and padded providing equipment with maximum protection against impact. The attache cases (AS-AL and AS-AM) are equipped with adjustable, closed cell dividers that are Velcro attached to conform to the needs of your equipment.



BAGS

543

### AS SERIES SPECIFICATIONS

| Model | SKU    | Type    | Interior (LxWxD)         | Lid (LxWxD) | Body Inner Dimensions | Weight   | Price |
|-------|--------|---------|--------------------------|-------------|-----------------------|----------|-------|
| ASAM  | HAASAM | Attaché | 13 3/4 x 4 1/4 x 10 1/4" | 3/4"        | 3 3/4"                | 4.6 lbs. | 54.95 |
| ASAL  | HAASAL | Attaché | 17 3/4 x 5 x 12 1/2"     | 3/4"        | 4 1/2"                | 8.1 lbs. | 69.95 |
| ASS   | HAASS  | Trunk   | 10 1/2 x 8 x 5 1/2"      | 1 1/4"      | 6"                    | 4.8 lbs. | 29.95 |
| ASM   | HAASM  | Trunk   | 12 1/4 x 8 1/4 x 6"      | 1 1/4"      | 6 1/2"                | 6.4 lbs. | 44.95 |
| ASL   | HAASL  | Trunk   | 13 3/4 x 8 3/4 x 7"      | 1 1/4"      | 7"                    | 8.4 lbs. | 54.95 |
| ASLL  | HAASLL | Trunk   | 15 1/2 x 11 1/2 x 8 3/4" | 1 1/2"      | 10"                   | 9.5 lbs. | 59.95 |



#### Pro Rolling Cart

The Pro Rolling Cart is a fully airline carry-on compatible rugged rolling case for efficiently transporting camera equipment with ease. The tough ballistic nylon exterior is made for a beating, and the telescoping handle is well reinforced to stay rigidly attached to the body of the case. Internally there's an extra high-density foam padded layer to fully encapsulate the gear in safety.

- ◆ Accommodates SLR, 6-8 lenses and flash
- ◆ Two internal mesh zippered pockets
- ◆ Large exterior front zippered pocket
- ◆ Side tripod holder
- ◆ Self-healing nylon coil zippers
- ◆ ID Pocket tag
- ◆ Exterior Dimensions: 14 x 22 x 8"; Interior Dimensions: 13.2 x 18.4 x 7" (WxHxD)

Pro Rolling Cart (HAPSRC20) .....148.50



PSBP-30 Pro Unibody Backpack

PSBP-40 Pro Two Compartment Backpack

#### PSBP Backpacks

The PSBP series of backpacks are made to last and created with innovative design. They can accommodate two 35mm SLRs, 5-6 lenses, flash, film, filters and other accessories. Either of the two designs will provide professional performance.

##### PSBP-30 Pro Unibody Backpack

- ◆ Large interior compartment equipped with movable foam-padded dividers
- ◆ Thick adjustable padded waistbelt
- ◆ Lash tabs and a netted pocket will hold a jacket or small tripod
- ◆ Breathable mesh padded nylon backing
- ◆ Reinforced padded bottom with rubber feet
- ◆ Self-healing nylon coil zippers throughout
- ◆ Meets airline carry-on size restrictions
- ◆ 13.6 x 19.2 x 8" exterior; 12 x 18 x 5.2" interior

PSBP-30 Pro Unibody Backpack (HAPSBP30) .....157.95

##### PSBP-40 Pro Two Compartment Backpack

Same as PSBP-30 except:

- ◆ Two separate adjustable interior compartments are equipped with movable foam-padded dividers
- ◆ 13 x 22 x 8.7" exterior; 11.7 x 20.9 x 7.2" interior

PSBP-40 Pro Two Compartment Backpack (HAPSBP40) .....174.95

**NOTE:** Airline specifications are subject to change. Always check with your carrier.

# KATA

## SHOULDER BAGS

BAGS

544

### **SB-904 Reporter Shoulder Bag**

The SB-904 easily carries and protects two SLR bodies with 6-8 lenses (up to 300mm), a flash unit, a battery booster and many more accessories and personal effects. A unique design allows you the freedom to arrange the bag to your desired working mode. Of the two padding kits provided with the bag, you can choose whether to use one, both or none, thus defining the rigidity and flexibility levels of the case. If additional division is necessary, Modi-Vers Kits are available. Two semi rigid TST front pockets and two large external side pockets ensure ample storage for any additional professional or personal equipment.

◆ A triple opening system has been engineered to allow for any working eventuality:

1. The main double buckle closing flap allows full access to all the equipment at once and is most convenient when loading and unloading the bag.
2. Quick "One Pull" top zippered flap allows for quick access to the working camera at all times.
3. Two side zipper openings enable the quick draw of lenses, flash unit or other accessories, without having to open the bag.

- ◆ Carrying options include reinforced rigid handle, shoulder strap and padded rear and belt loops for extra waist support (belt not included). The SB-904 zippers and openings are rain protected and an Elements Cover for the entire case is supplied for extreme climatic conditions.

◆ Internal main compartment measures 13.3 x 9.4 x 8.6"; external dimensions are 18.8 x 14.9 x 11.8", and it weighs 2.4 lbs.

**SB-904 Reporter Shoulder Bag.....129.95**



### **WS-604 Waist-Shoulder Bag**

Designed for the professional photographer on the go, the WS-604 is ergonomically designed to allow you to "shoot from the hip" without taking the case off your shoulder: Contoured shape for a closer to the body center of gravity; 2 DP Buckles ensure correct Case-Strap-Carrier angle; ergonomic Non-Slip Shoulder strap; opening away from the body by a quick release buckle; 3D hip pad with a concealed hip belt for additional support and weight distribution. In the main compartment, the 3 large pockets, 4 flat pockets and the tying loops, the WS-604 will store all you need: 1-2 SLR bodies, 2-4 lenses, flash, battery packs, filters, tripod, PDA and other photo and personal accessories. If additional division is necessary Kata's Modi-Vers Kits are available. The internal main compartment measures 12.6 x 8.3 x 7.9"; the external dimensions are 17.7 x 11 x 9.1", and it weighs 2.9 lbs .....

.....119.95

### **MC-61 Shoulder Bag**

The MC-61 Multi-Case is the perfect companion for the genuine field photographer. It combines all you'll need in one case: It offers the option of carrying several camera bodies with a variety of additional lenses (mounted or separate), combined with a laptop, professional and personal accessories - holding each piece of equipment and gear in its own designated compartment; Featuring a level of protection you haven't seen before, provided by the TST and the well padded sides of the bag; Multiple and ergonomically perfected carrying possibilities - The B shaped shoulder strap, the Click handle and the Insertrolley option. All this in a compact case that can be carried on board a plane and stored in the overhead bin. Internal main compartment measures 19.3 x 8.3 x 10.6" (LxWxH), external dimensions are 20 x 12.2 x 12.6" (LxWxH). Weighs 5.5 lbs.

- ◆ Service compartment can be divided and organized to fit all extra gear like batteries, charger, cables, lenses and many more.
- ◆ Two side doors open a long padded back compartment where you can store a small tripod or many accessories organized inside the two included drawers.

- ◆ 2 sets of Modi-Vers to allow for partitioning according to your preference
- ◆ Front pocket for personal effects like PDA, wallet, cell-phone etc.
- ◆ Padded mesh pockets for flat items like filters
- ◆ Tripod holding recess and straps



- ◆ 6 openings allow for separate access to camera, laptop and accessories.
- ◆ Fits all types of laptops with mouse, cables etc.
- ◆ Full opening for easy access to large camera configurations

**MC-61 Shoulder Bag.....159.95**



**EQUIPMENT LEASING AVAILABLE**

# KATA

## SHOULDER BAGS

### Banana-1/Banana-2/Banana Shoulder Cases

Banana cases are roomy, heavy-duty cases built to hold a large assortment of equipment. Their contoured shape allows the center of gravity to be close to the body and releases the shoulder from stress. The opening of the case faces towards your body in the carry mode, allowing you complete view of its contents and easy access to your gear. A Modi-Vers divider is included to customize your contents, additional MVK-10 and MVK-20 Modi-Vers divider kits are available. Ergonomically designed lift handles on both sides fit the contour of your hand and angle forward to allow higher lifting and holding of bag closer to the body. The front has a zippered mesh pocket, 2 roomy, zippered exterior pockets and an ID Window. The case can be carried by a NSS (Banana 1) or APSS (Banana 2 and 3) shoulder strap, inverted interlocking handles or the optional DTS Insertrolley.

- ◆ 1000 denier water-repellent Cordura exterior and contoured, thickly padded interior with six layers of protection
- ◆ Extra reinforced heavily foam-padded sides stiffened with aluminum panels
- ◆ Ergonomically designed lift handles fit the contour of your hand, and angle forward to allow higher lifting and holding of bag closer to body.

- ◆ Banana Shoulder Bags are carried by a non-slip shoulder strap with camera snap connectors or with a padded and reinforced inverted interlocking handles.
- ◆ A flat side pocket holds the shoulder strap during transport. A zippered, mesh inside pocket can be used as one or two pockets
- ◆ Connecting points for extra-long equipment like a tripod



- ◆ Toblerone shock absorbers are made from synthetic thermo-rubber that absorbs shocks and protects the case from abrasion, dirt, mud and standing water
- ◆ Modi-Vers dividers attach to the interior loop fabric, called Yelloop. It is a bright yellow material, so that the contents can be viewed with ease.

|   |               |
|---|---------------|
| <b>Banana 1 (KAB1):</b> Internal dimensions are 17.7 x 8.7 x 10.6", external dimensions are 19.7 x 13 x 11.4". Weighs 6 lbs.....    | <b>279.95</b> |
| <b>Banana 2 (KAB2):</b> Internal dimensions are 21.7 x 11 x 10.6", external dimensions are 22.8 x 12.6 x 12.2". Weighs 7.3 lbs..... | <b>314.95</b> |
| <b>Banana 3 (KAB3):</b> Internal dimensions are 23.6 x 11 x 11.8", external dimensions are 24.8 x 12.6 x 13.4". Weighs 8.8 lbs..... | <b>329.95</b> |



### Maze-1/Maze-2 Shoulder Cases

Designed to withstand hard use in any environment, Maze cases are thickly padded and reinforced with Polypropylene panels to provide extra protection. The main compartment can be customized to fit a variety of equipment, while the additional pockets help organize all required accessories. An SLR and 3-4 lenses will fit in the Maze-1 and twice the amount in the Maze-2 with additional equipment like flash, filters, batteries, media kits, light meter, tripod and many more. All of the equipment will be revealed and ready for use, once the main wraparound zipper is opened. The interiors of the cases can be customized with the Modi-Vers divider system, and both are Insertrolley compatible.

**Maze 1 (KAM1Z):** Internal main compartment measures 15 x 5.5 x 10.2" (LxWxH), external dimensions are 16.5 x 6.3 x 12.6" (LxWxH). Weighs 2.5 lbs.....**179.50**

**Maze 2 (KAM2Z):** Internal main compartment measures 19.7 x 7.1 x 13.8" (LxWxH), external dimensions are 20.9 x 7.9 x 17.7" (LxWxH). Weighs 4.2 lbs.....**239.95**

### Exo-7 and Exo-12 Small Shoulder Cases

The Exo-7 and Exo-12 accommodate an SLR body with up to a 80-200mm lens mounted and personal accessories. A back "service door" opens a lower compartment that can hold a charger, batteries, and cables. If needed, the lower divider can be removed to create a larger main compartment. Specially designed pouches are included and can be attached to both ends of the bag. The EXO cases come with an attachment system for small tripods. A BSS Strap is included and the interior can be customized with Modi-Vers and Filter Sleeve.

**Exo-7 (KAEXO7)**  
Internal main compartment measures 7.9 x 4.7 x 6.7", external dimensions are 9.8 x 8.3 x 7.5" (LxWxH). Weighs 2.1 lbs.....**64.95**

**Exo-12 (KAEXO12)**  
Internal main compartment measures 11 x 4.7 x 8.3", external dimensions are 12.6 x 8.3 x 9" (LxWxH). Weighs 2.5 lbs.....**69.95**



BAGS

545



# KATA

## CAMERA CASES

BAGS

546

### C-52/C-54 Camera Pouches

The stylish C-52 and C-54 are unique, TST protected, mini camera cases. Their main compartment can accommodate a digital camera, 4 spare batteries and 2 memory cards (in the elastic pop-out media kit). The C-54 features back and top 3D Air-Mesh pockets that store accessories like filters, cleaning kit, tools and more. Carried on the belt or with the adjustable shoulder strap, the C-52 and C-54 will make sure you have it all close at hand. They provide double protection from moisture and dust by the folded zipper and unique "internal wall". In rain, use the elements' cover, black side out, and in sun reverse to silver for heat reflection.

#### C-52 Camera Pouch (KAC52CCS)

Internal main compartment measures 3.1 x 2.0 x 3.7", external dimensions are 3.9 x 3.1 x 5.5" (LxWxH). Weighs 0.22 lb .....**23.95**

#### C-54 Camera Pouch (KAC54CCM)

Internal main compartment measures 3.9 x 2.4 x 5.1", external dimensions are 4.7 x 3.5 x 6.3" (LxWxH). Weighs 0.30 lb .....**28.95**



### C-56/C-58/C-59 Camera Cases

Stylish, ergonomically designed and TST protected, the C-56, C-58 and C-59 are identical in all but size. Their main compartment accommodates a digital camera with zoom lens, a small SLR or a camcorder, with additional lenses, flash-unit, charger and other equipment. Five padded internal/external pockets and a separate media kit will hold extra gear, close at hand. Carrying options include Elasto-Rubber handle, SPAD shoulder strap and and back loops for a waist belt. The cases' folded zipper and unique "internal wall" provides double protection from moisture and dust. In rain, use the elements' cover, black side out, and in sun reverse to silver for heat reflection.

**C-56 Camera Case (KAC56CCL):** Internal main compartment measures 5.1 x 5.1 x 6.7" (LxWxH), external dimensions are 9.1 x 5.5 x 9.1" (LxWxH). Weighs 0.67 lb .....**39.95**

**C-58 Camera Case (KAC58CCXL):** Internal main compartment measures 7.1 x 5.9 x 8.7" (LxWxH), external dimensions are 11.8 x 7.9 x 10.2" (LxWxH). Weighs 1.08 lbs .....**58.95**

**C-59 Camera Case (KAC59):** Internal main compartment measures 11 x 7 x 9.4" (LxWxH), external dimensions are 16.5 x 9.8 x 13.3" (LxWxH). Weighs 1.9 lbs .....**69.95**

### P-Series Camera Pouches

Multipurpose bags providing complete TST protection, the P-32 and P-34 can be carried either on your belt, in your satchel or as a part of a transporting organizing system. The P-36 can also be threaded through your shoulder bag, while the P-38 can be carried by its handle or adjustable shoulder strap. These cases feature multipurpose configuration options:

**P-32 Camera Pouch (KAP32WS):** Store a miniature digital camera; 2 Mini DV tapes; four media memory cards plus 4 AA batteries and many more options. Internal main compartment measures 2.8 x 1.2 x 3.7", external dimensions are 3.5 x 1.4 x 4.7" (LxWxH), and it weighs 0.2 lb .....**13.95**

**P-34 Camera Pouch (KAP34WM):** The P-34 holds four Mini DV tapes; a small digital camera; pocket camcorder; charger and cables; a PDA and many more. The pull-out Media-Kits can be cut away if needed. Elastic bands will help hold contents in place while the two adjustable side-connectors allow you to set the opening size according to carrying method and equipment. Internal main compartment measures 3.7 x 2.4 x 5.5", external dimensions are 4.5 x 2.8 x 6.7", it weighs 0.3 lb .....**16.95**



**P-36 Camera Pouch (KAP36WL):** Holds two battery packs, a small digital camera, or various accessories like cables and charger. Two separate compartments have internal pockets that accommodate media cards and additional equipment. There are two opening methods: a top auto-flip-back lid and full peripheral zipper access. Internal main compartment measures 3.1 x 2 x 6.1", external dimensions are 3.9 x 2.6 x 7.1", and it weighs 0.3 lb .....**20.95**

**P-38 Camera Pouch (KAP38WXL):** Holds either a pro SLR body, a medium digital camera, or a small Mini DV camcorder. Two separate compartments share volume according to content and allow for additional equipment. Unique opening methods include a top auto-flip-back lid and full peripheral zipper access. Internal main compartment measures 6.9 x 3.1 x 6.9", external dimensions are 8.7 x 3.9 x 9.1", and it weighs 0.6 lb .....**31.95**



## CAMERA SLING CARRIERS

BAGS

547

### S-308 Sling Case Carrier (KAS308SCS)

The S-308 is a multifunctional, shooting-gear-carrier. It can be used individually, with its own expandable pocket, or as a platform for one of Kata's cases (with the included connecting system). Change the carrying position by shifting and turning: camera case in front for quick access, on the side as a shoulder bag or on your back for optimal weight distribution. An adjustable shoulder pad makes sure the S-308 is comfortable in all positions and fits sizes S to XL. Additional pockets allow you to keep valuables close to your body, in the concealed compartment, and accessories like a cell phone, PDA and wallet in the designated pouches. Dimensions are 13.8 x 2.0 x 13.8", and it weighs 4 lbs.....37.95

### S-312 Camera Sling (KAS312SCL)

The S-312 incorporates TST protection and is ergonomically designed to carry a camera or pocket camcorder. The unique diagonal configuration offers an alternative to traditional carrying methods and fits sizes S to XL. The camera can be placed in either of the two front pockets. A concealed compartment holds valuables close to your body. Other pockets hold a cell-phone, PDA, pen, media cards, spare batteries, keys and more. It's external dimensions are 13.8 x 2.8 x 8.7", and it weighs 0.8 lb.....34.95



S-308 Sling Case Carrier

S-312  
Camera Sling

### T-212 Torso-Pack (KAT212TP)

The T-212 is uniquely designed to keep your SLR in quick-draw position, while TST protected. The T-212 enables frontal carrying without weighing on your neck. The shape of the main compartment adjusts to fit your gear and can be divided into two sections. Additional pockets will store all necessary accessories. The T-212 can be used on its own (with the weight distributing back-mesh piece) or attached to the W-92 Waist Pack as well as one of the backpacks. Internal main compartment measures 11.8 x 3.9 x 9.8", external dimensions are 15.7 x 4.7 x 15.7" (LxWxH). Weighs 1 lb .....62.95



T-212  
Torso-Pack



### H-12/H-14 Camera Holsters

These revolutionary holsters give extra TST protection while allowing for quick access to your SLR and zoom lens. The camera is held in place by looping the divider around the lens vertically or positioning it horizontally and creating a bottom compartment for an additional lens or flash. The media kit holds batteries and memory cards. Five padded accessory pockets stores filters, cleaning kit, light meter, cell-phone, PDA and many more. Carry the holster with a handle, shoulder strap or a 3D-mesh loop for your waist belt. These holsters feature a double closure system - a two-slider zipper and a one-hand operating buckle. In addition to the rain-protected lid they are equipped with Kata's unique elements cover: black side out in rain, silver side out in the sun for heat reflection.

H-12 (KAH12H): Dimensions are 9.4 x 6.7 x 11.4", and it weighs 1 lb.....58.95

H-14 (KAH14H): Dimensions are 13.3 x 7 x 11.8", and it weighs 1.5 lbs .....73.95

### W-92 Waist Pack

Designed for SLR systems, the W-92 incorporates TST protection and can be comfortably worn in the front for quick access while opening the cover away from your body, or in the rear for best weight distribution. It can be carried by the thermo-rubber handle or as a shoulder bag with the SPAD strap hooked to the 2 D-rings (the waist belt can be tucked away or buckled for extra stability). Arrange the main compartment and the seven independent pouches to fit your gear. A pro SLR with 2-4 lenses and additional gear like flash, hood, charger, power supply, etc. will fit in this roomy pack. The front divider enables internal and external approach to the TST pocket. Two padded expandable pouches on both sides accommodate lenses or any other item you would like to have close at hand. Additional pockets in the lid, front TST and two sides of the W-92 will store all required accessories. Full protection on the main zipper and Kata's unique cover makes sure your equipment is well protected from the elements.

W-92 (KAW92): Dimensions are 16.5 x 9.8 x 7.1", and it weighs 1.5 lbs .....66.95

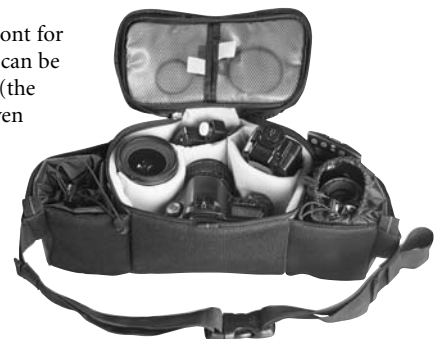

# KATA

## BACKPACKS

BAGS

548

### R-102/R-103 Rucksacks

The compact R-102 and R-103 hold an SLR with up to a 300mm lens attached, an extra body, 4-5 lenses or a mini DV camcorder. Additional accessories, like flash, filters, charger, cables can be stored in the spacious arched lid compartment, the two outside pockets and the central mesh/vinyl pocket. An ergonomic harness includes a unique cushioning and shock absorbing system, which allows for optimal ventilation, weight distribution and 5-point adjustment mechanism. They include a well-padded dividing set, a TST tripod holder and an adjustable strap. They can also be carried with an optional camera strap or with a detachable hip belt. Kata's unique cover protects your equipment from the elements. Otherwise identical, the R-103 adds a designated laptop compartment.

R-102 (KAR102RS): 14.6 x 7.9 x 20.9", it weighs 3 lbs .....139.95

R-103 (KAR103RS): 14.17 x 7.9 x 20.8", it weighs 3.75 lbs .....159.95

### HB-207 Hiker Backpack (KAHBP)

The HB-207 features Thermo Shield Technology TST protection, which safeguards your camera while keeping the case light. The main compartment easily accommodates 2-3 SLRs with up to 8 lenses (up to 400mm). The case is set up with modular dividers, and if additional division is necessary, Modi-Vers Kits can be purchased. The top compartment holds your camera with an attached lens for quick removal. Large rear laptop compartment, two soft TST open pockets for water bottles, small tripod etc., and an assortment of pockets provide the ultimate carrying solution for outdoor photographers. A tripod can be attached on the front or side of the backpack. The advanced harness system offers adjustment of all features; shoulder straps, 6-point adjustable waist belt, and lumbar pad. Dimensions are 15.3 x 11.8 x 25.2", and it weighs 6.1 lbs.....199.95



R-102 Rucksack

R-103 Rucksack



BP-502 Backpack

Panda-402 Camera Backpack

### BP-502 Backpack (KABP502)

Designed for pro SLR cameras with zoom or telephoto lenses, a laptop and accessories. Thermo Shield Technology (TST) combined with traditional craftsmanship create this lightweight, ultra-protective case. The main compartment features a unique internal dividing system, which allows for many different setups. And using the optional Modi-Vers divider system, you can customize the interior to meet your requirements. The camera is placed in the center for easy access via the small top opening flap, while related equipment is secured in place by flap doors that can be folded away when needed. The BP-502 features additional internal and external pockets, a peripheral zipper opening, and a flat rear compartment for a laptop and accessories. Carrying options include an adjustable ergonomic harness system, an Insertrolley connection sleeve, and an injected grip handle. The BP-502 includes a double-sided elements cover, a tripod sling and securing straps, and camera straps which are connected to the harness but can be removed to create an independent camera carrying strap. Dimensions are 23 x 17.7x 12.2", and it weighs 8.6 lbs .....249.95

### Panda-402 Camera Backpack (KAP402)

The Panda-402 features Kata's TST which safeguards the camera compartment and the bottom of the case. It easily accommodates 1-2 camera bodies with 2-3 lenses or a DV camcorder in the upper compartment, and a laptop with its accessories in the lower compartment. A dual zipper enables separate access to each compartment or access to all your equipment at once. Ample external and internal pockets provide storage solutions for a range of accessories and personal effects. Using the Modi-Vers divider system you can customize the interior to meet your exact requirements. A tripod can be carried on the Panda's side or in the central pocket. The Panda-402 is the ultimate solution for the needs of field production work, and it meets the strict new airline regulations for carry-on bag size. It can be turned into a shoulder case by utilizing the Omega concealment system, and the included BSS shoulder strap, or can be wheeled along on the Insertrolley .....164.95



## RAIN COVERS

### CRC-13/CRC-14 Compact Rain Covers



These compact rain covers fit 35mm cameras allowing you to continue shooting in harsh weather conditions. Simply slip over your camera and secure with the adjusters and pull-cords. The closure along the bottom rim enables quick set-up and seals the tripod connection, while also providing a hand held option. The CRC-13 is the compact version while the CRC-14 is larger and fits longer lenses. They fit DV camcorders as well.

- CRC-13 (KARC13): Weighs 0.2 lbs.....**69.95**
- CRC-14 (KARC14): Weighs 0.45 lbs.....**79.95**

### E-702 Elements Cover (KAE702CRC)

The E-702 lets you continue shooting in harsh weather conditions. It slips over the camera and is secured quickly and easily with the adjusters, and pull-cords. Two roomy sleeves provide easy access to all camera and lens controls, while the transparent TPU enables easy monitoring all the time. An adjustable PP hood fits a variety of lens diameters. A full-length double zippers enables complete closure when hand held or on a tripod. The E-702 fits all types of SLR cameras with or without booster or grip .....**42.50**



### E-704 Lens Sleeve Kit (KAE704LRC)



The E-704 consists of two lens sleeves, up to 350 and 650mm long and one hand sleeve. It is designed to be attached to the E-702 when shooting with zoom or telephoto lenses. Full length closure along the bottom rim

enable quick set-up, and seals tripod connection, while also providing an option to access the lens controls at any point. For sealed access the hand sleeve can be connected wherever convenient. The PP hood can be adjusted to fit a variety of lens diameters.....**49.95**

### E-690 Elements Cover (KAE690CRC)

The E-690 is a practical cover for small SLR and digital cameras such as the Nikon D70 or the Canon Rebel series. When suddenly caught by a rain shower the E-690 slips quickly over your camera and allows you to keep on shooting. Access to all camera and lens controls via two side sleeves. A clear view through the transparent TPU enables easy monitoring all the time. Full-length double zipper provides bottom closure when hand held or on a tripod. Once used you will not understand how you managed without this item.....**32.95**



## OPTIONAL ACCESSORIES

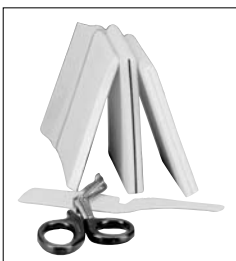

### Modi-Vers Kits

Create compartments to meet your requirements. The divider can be cut with scissors to any desired size. Attach the newly cut divider to another divider or the walls of the bag with the special hook and loop connectors.

**Modi-Vers Kit 10 (KAMVK10):** Includes a 40" long x 4" high, semi-rigid divider strip and 10 connectors.....**22.95**

**Modi-Vers Kit 20 (KAMVK20):** Same as above with a 40" long x 8" high, semi-rigid divider strip .....**26.95**

**Soft Modi-Vers Kit 10 (KAMVKS10):** Includes a 20" long x 4" high, soft divider strip and connectors .....**16.95**

**Soft Modi-Vers Kit 20 (KAMVKS20):** Same as above with a 20" long x 8" high, soft divider strip.....**19.95**



### Insertrolley (KT VG-DTS)

The simple yet ingenious Insertrolley System can be used with many Kata cases. It allows you to either use the trolley separately or with more than one case. Simply slide the trolley through the "sleeve" on the cases for secure and easy mobility. You can detach the trolley when you want to store it and easily replace it if damaged. Patented extendable wheel system helps to better stabilize larger cases. It's dimensions are 11.8 x 3.9 x 18.9", and it weighs 4 lbs .....**CALL**

### Filter Sleeves

Flat translucent pouches designed to hold round filters. Many Kata cases come with a Filter Sleeve connector, which is a designated strap connector that allows you to secure as many Filter Sleeves as necessary.



**Filter Sleeve 43 (KAFS43):** Holds filters up to 43mm .....**3.95**

**Filter Sleeve 62 (KAFS62):** Holds filters up to 62mm .....**3.95**

**Filter Sleeve 82 (KAFS82):** Holds filters up to 82mm .....**4.95**

# LIGHTWARE

## MULTI FORMATS

BAGS

550

Whether you need to fit a medium format or 35mm system, or a complete lighting system with packs, heads, stands and umbrellas, Lightware has a Multi Format Case that will work for you. Lightware offers many convenient Multi Format sizes to accommodate all of your packing needs. Most Multi Formats also come with an outside slash pocket to store your color cards, model releases, layouts or similar items. These pockets also accept a Multi Z Pocket, which is actually a mini briefcase with a removable mesh film bag. This comes in handy at airport x-ray security counters. You will find these cases great to carry a variety of smaller strobe equipment and flash heads. Many 4x5 field view cameras fit nicely into these cases, as well as film, meters, film holders, lenses, and a myriad of other accessories. Better yet, the lid of these cases, when open, can be used as a handy clean work surface to load cameras or lay film backs on when working on location.



**MultiFormat 1629** (LIMF1629)  
Lightware's largest airline checkable case. Great for lights, small stands, soft boxes and accessories. A complete location lighting kit can be assembled in this case. The customizable divider system allows you to mix and match light sizes. Carry a set of head extensions, grids, barn doors and gels, umbrellas and small reflectors with ease. 31 x 17.5 x 12" .....**419.95**

**Rolling MultiFormat RMF1629** (LIRMF1629)  
Similar to the MF1629 with a double set of dual wheels and an easy top pull handle. A set of quick release buckles allow you to quickly close the case while shooting on the fly. 33 x 17.5 x 12.5" .....**554.50**

**MultiFormat 1623** (LIMF1623)  
An airline checkable case that is great for lights, small stands, soft boxes and accessories. The customizable divider system allows you to mix and match fixture sizes. 25 x 18 x 10" .....**359.95**

**MultiFormat 1420** (LIMF1420)  
Ideal for small strobe systems or a whole bunch of medium format and/or 35mm camera equipment. Two stash pockets on the inside lid hold instruction manuals, extra flash cards, a pocket reader, cables and some CD's. It accepts the optional detachable "Z Pocket" briefcase. 22 x 16 x 8" .....**298.95**



Rolling MultiFormat RMF1629

MultiFormat MF1629

MultiFormat 1420

MultiFormat 1217

MultiFormat 912

**MultiFormat 2012** (LIMF2012)  
Similar to the MF1420 but is sized as an airline carry on. It accepts a complete SLR camera system. Take it on the aircraft or wheel it on with a MultiMate 2012. 21 x 14 x 8.5" .....**304.95**

**MultiFormat 1217** (LIMF1217)  
An airline carry on, the 1217 is ideal for a modest medium format system and/or a 35mm camera set up. It has 2 stash pockets on the inside lid, and accepts the optional detachable "Z Pocket" briefcase. 19 x 14 x 8" .....**272.50**

**MultiFormat 1015** (LIMF1015)  
Designed for a couple of cameras and lenses up to a 300 f/2.8, or a small 4x5 view camera, holders, a few lenses. Great for airline carry on. It accepts the optional "Z Pocket" briefcase. Dimensions are 17x 12 x 10" .....**268.95**

**MultiFormat 912** (LIMF912)  
Perfect for a couple of 35mm bodies, four lenses, including a 80-200 f/2.8, a flash and accessories. It can also fit a basic medium format body, 3 to 4 lenses, and a couple of backs. It accepts the optional "Z Pocket" briefcase. 14.5 x 11 x 8.5" .....**206.50**



For Any Inquiries Regarding Your Order, Call Our Customer Service:  
(800) 221-5743 • (212) 239-7765 • FAX: (800) 947-2215 • (212) 239-7549

# LIGHTWARE

## CARTS & BACKPACKS

### MULTI MATES

Convert any MF2012, MF1420 or MF1623 Multi Format case into a rolling case with a mere snap of a buckle. Your Multi Format case is held in place with 2" wide webbing and a buckle closure that allows you to work out of the case even while it's in the MultiMate. And, if you need to move from spot to spot at your location, it's not necessary to zip up the case each time; just buckle down the lid and you're off to the next set-up. Made from durable LDPE plastic, MultiMate's are close to being indestructible.

The handle assembly is incorporated in the body of the tray so it is well protected from luggage eating conveyor belts. Additionally, the handle retracts neatly into a protective recess that lies below the top of the case.



**MM1623 Multi Mate Cart** (LIMM1623)  
For MF1623 Case .....**135.50**

**MM1420 Multi Mate Cart** (LIMM1420)  
For MF1420 Case .....**126.95**

**MM2012 Multi Mate Cart** (LIMM2012)  
For MF2012 Case .....**126.95**

BAGS

### BACKPACKS & ACCESSORIES

#### Backpack BP1420

The Backpack 1420 is a comfortable backpack and a shipping case in one. It comes with a true harness system which includes a padded waist belt, padded lumbar support, adjustable shoulder straps, and a chest strap to make it as comfortable as possible. Best of all, when not used as a backpack, the entire harness hides away in a special cover flap. There are strong handles on both the back and the side for when you're carrying it as a case. The most unique feature of the BP1420 is that it accepts the inner shell of the Multi Format MF1420. Valuable time can be saved simply by switching the interior from case to case. Dimensions are 17 x 7 x 25" .....**272.50**



551

**1420 Tote Shell Box** (LITS1420)  
Molded insert to fit the BP1420. It is the same interior as the MF1420. It comes with customizable dividers .....**106.95**

**1420 Divider Set** (LIDKDMF)  
For MF1420 and BP1420 cases. Includes 5 dividers and 24 hooks so you can set up your equipment in virtually any way you need .....**52.95**

**Tripod Slingpack** (LIC6099)  
A padded ballistic nylon bag that accommodates a tripod up to 40" collapsed. It can be strapped to the BP1420, carried alone, or used with the A8010 optional shoulder strap. 40 x 11 x 11" .....**63.50**

**Multi Z Pocket** (LIZ1091)  
A small briefcase that can be attached and detached to the BP1420. It has outside pockets for an airline ticket and a magazine, and an inside net pouch that clips in and out. Places for notes, CD's, pens, etc. 13.25 x 3 x 11" .....**102.95**



**Z Pocket** (LIZ100)  
An attachable and detachable padded camera pocket that fits most 35mm camera bodies with motor drives. It attaches to the BP1420. 7.3 x 3.5 x 8.5" .....**65.95**

**GripPack** (LIBP1417)  
A watertight and stubbornly tough backpack that serves as a great shooter's bag as well as a travel bag. A removable structured insert with moveable dividers holds a camera body, two or three lenses plus a flash. It also has loads of pockets: an interior net pocket for accessories, two side pockets for small items, and a hidden pocket hides your extra cash. In addition, two D rings allow you to hang accessories like light meters. 13 x 9 x 19" .....**154.95**

ORDER & INFO. (212) 502-6340 • FAX: (212) 239-7770 (800) 947-7008  
**1-800-290-6750 • www.bhphotovideo.com**



# LIGHTWARE

## BRIEFCASES, PORTFOLIOS & DUFFLES

### ATTACHES & BRIEFCASES

BAGS

552

#### Small Format Attache Case (LISA4030)

This camera case is made from Lexan and I-Core, a lightweight plastic corrugated board encased in foam. It comes with pre-diced foam that can be plucked to fit a 35mm system and accessories. 20 x 14 x 5.5" ..154.95

#### Briefcase (LIBF8050)

A spacious briefcase with an abundance of pockets including a roomy central pocket to stuff beefier items in. Two exterior pockets fit magazines and airline tickets. A shallow zippered pocket holds keys or sunglasses. A workable solution to help organize the essentials of your digital life. 20 x 14 x 5" .....167.95

#### Courier Briefcase (LIBF1250)

An expandable soft case with plenty of compartments. Roomy, yet manageable enough to sling over your shoulder, it has a fold over flap that allows easy access to pockets, pouches and zippered compartments. ....Zip the zipper and the main compartment becomes almost twice as big. 17.75 x 2-4 x 13" ...134.50



#### Laptop Courier Briefcase (LIBF128)

A Courier Briefcase that has a center compartment sized to fit the largest of laptops. 17.5 x 8 x 13" .....169.95

#### Courier Padded Insert (LIBF1211)

A great little carry all for just the computer. Storage on the front so you can burn a few CD's or have the presentation easily at hand. 14 x 2 x 11" .....34.95

#### Laptop Digital Messenger (LIMB1758)

This camera bag has a removable padded insert for an SLR, 3 lenses with hoods, and a flash. A separate removable padded insert with a rigid protective sleeve holds your laptop computer. They also have a multitude of internal and external pockets. Dimensions are 17.5 x 7 x 12" .....218.50

#### Digital Messenger Shoulder Bag (LIMB1606)

Same as the Laptop Digital Messenger bag except that there is no second laptop insert. 15.5 x 6 x 11" .....176.50

### FOLIO COVERS / PORTFOLIOS

#### 16 x 20 Folio Cover (LIFC1620)

A padded carrying cover that fits snugly around an archival presentation box with a handy buckle down closure. It can also be used as a soft side briefcase or or an art folio. Dimensions are 20.75 x 16.75 x 2.5" .....77.95

#### 11 x 14 Folio Cover (LIFC1114)

Same as above. 15 x 12 x 2.5" .....69.50

#### 8 x 10 Folio Cover (LIFC810)

Same as above. 11 x 9 x 2.5" .....59.95



#### 16 x 20 Portfolio (LIP8060)

Portfolio cases come with a leather business card holder and an inside lid pocket for tear sheets or reprints. Lined with a soft tricot fabric, it has a strong shell for protecting your portfolio pieces. 21.5 x 17 x 3" .....147.50

#### 11 x 14 Portfolio (LIP8040)

Same as above. 15.5 x 12 x 3" .....110.95

#### 8 x 10 Portfolio (LIP8030)

Same as above. 11.5 x 9 x 3" .....99.95

### DUFFLES



A great way to take along cloth backgrounds, cables, clamps, toolboxes, accessories or even clothes. Made from durable black ballastic nylon accented with a silver stripe, these duffles are built to last the rigors of airline travel. They come with a roomy main compartment that is accessed through the top "U" zip lid. Two zippered end compartments and a long zip pocket on the front side organize some of your smaller items. A padded carrying handle and a non slip padded shoulder strap is included.

Xtra Small Light Duffel (LILD2100): 21.75 x 9.5 x 10.25"; 3 lbs .....149.95



EQUIPMENT LEASING AVAILABLE



# LIGHTWARE

## POWER KITS & CARGO CASES

### POWER KIT CASES



Lightware Power Kit cases have withstood the test of time and proven that their construction is hearty enough for the toughest travel conditions. These cases are built with an internal, super lightweight structure of GE Lexan. They are then covered with shock absorbent closed cell foam with padded hook and loop compatible tricot. This is all encapsulated in a shell of puncture and abrasion resistant ballistics fabric.

The best thing about these cases is that they come with moveable dividers for greater case versatility in order to handle a variety of packing needs. Shorter dividers are available - or with a little cutting and re-sewing, these dividers can be shortened in height to allow stands, umbrellas or soft boxes to be packed into cases along with strobe heads, packs and accessories. The end result is a case with superior shock absorption, enough rigidity to bear a sizeable load of weight and a wall of Lexan to ward off the puncture demons.

|   |  |  |   |
|---|--|--|---|
| <b>Power Kit 1800</b> (LIPK1800)<br>31.5 x 10 x 21" ..... <b>415.95</b> | <b>Power Kit 1600</b> (LIPK1600)<br>29.75 x 10 x 19" ..... <b>365.50</b> | <b>Power Kit 1400</b> (LIPK1400)<br>22.75 x 10 x 17.5" ..... <b>312.95</b> | <b>Power Kit 1200</b> (LIPK1200)<br>17 x 10 x 15" ..... <b>266.50</b> |
|---|--|--|---|

### CARGO CASES

#### Cargo Cases

Cargo Cases carry all sorts of equipment such as light stands, tripods, booms, umbrellas and power cables. Toss in some portable lightbanks, head extension cables, clips, tape, and diffusion materials. Add some tools, black velvet, a little air, grids, barn doors, gels and reflectors. If you need to carry flash heads or smaller strobe power supplies, pack them inside a Head Pouch, then slip them inside the Cargo Case.

|  |
|--|
| <b>52" Cargo Case</b> (LIC6052)<br>52 x 12 x 12"; 6.25 lbs ..... <b>234.95</b> |
| <b>42" Cargo Case</b> (LIC6042)<br>42 x 12 x 12"; 5 lbs ..... <b>189.95</b>    |
| <b>32" Cargo Case</b> (LIC6032)<br>32 x 12 x 12"; 4.5 lbs ..... <b>162.95</b>  |
| <b>24" Cargo Case</b> (LIC6024)<br>24 x 12 x 12"; 3.5 lbs ..... <b>139.50</b>  |

#### Rolling Cargo Cases

Made with a rigid inner core covered with soft tricot, the rolling version of the cargo case comes with in-line skate wheels and a protective molded kickplate for easy handling. It has a flip lid that can be buckled shut for quick closures while shooting on the fly, and a zippered top for easy accessibility. These cases have a foam padded end handle and a webbing handle on the sides. The interior lid has two sleeved compartments for light boxes or umbrellas. One long divider and several smaller dividers are included to help organize and separate your equipment in an efficient manner.

|  |
|--|
| <b>Rolling Cargo Case</b> (LIRC1042)<br>48.5 x 14 x 12.5"; 22.75 lbs ..... <b>544.95</b>     |
| <b>Small Rolling Cargo Case</b> (LIRC1032)<br>39.25 x 15 x 13.5"; 23 lbs ..... <b>519.95</b> |

#### Flip Lid Cargo Case

For those who want to carry only a background set up with long stands, support poles and boom arms. Similar to the Cargo Cases, it features a unique flip lid opening that stays open so you can easily load and unload your gear. It accommodates most large set ups and it's trim girth is easy to handle.

|   |   |   |
|---|---|---|
| <b>62" Flip Lid Cargo Case</b> (LIC6062)<br>63 x 9 x 8.5" ..... <b>249.95</b> | <b>50" Flip Lid Cargo Case</b> (LIC6050)<br>51 x 9 x 8.5" ..... <b>204.95</b> | <b>38" Flip Lid Cargo Case</b> (LIC6037)<br>39 x 9 x 8.5" ..... <b>179.95</b> |
|---|---|---|



Cargo Cases



Rolling Cargo Case



Flip Lid Cargo Cases

BAGS

553

# LIGHTWARE

## TRIPOD & STROBE HEAD CASES

### STAND & TRIPOD CASES

BAGS

554

#### Rolling Stand Bag 38 (LIRC1038)

For those who prefer to roll their stands, umbrellas, soft boxes and tripods. It features adjustable cinch down straps with quick release buckles, a rigid, interior back plate and a set of "double wide" wheels. In addition, it has a padded grip handle on the end as well as a padded carrying handle on the side. 43 x 10.5 x 9.25" .....**262.95**

#### Rolling Stand Bag 48 (LIRC1048)

Same as the above Rolling Stand Bag, but a bit bigger. 53 x 10.5 x 9.25" .....**295.95**

#### Stand Sock (LIC6038B)

A soft padded case that holds any lightstand up to 37". 38 x 5.75 x 5" .....**24.95**

#### PodPack (LIC6039)

An easy way to pack just a few things for a quick portrait. A slim gusset provides a center compartment with enough space to accommodate a large tripod. Two padded interior sleeves keep your stands, soft boxes or umbrellas separate and protected. Two outside stash pockets accept accessories. 39.5 x 5 x 10.5" .....**143.95**

#### Tripod SlingPack (LIC6099)

A hefty padded ballistic bag that accommodates a tripod up to 40". Now it is simple to carry a single tripod on location using the shoulder strap attachments. It can also be strapped to the Backpack BP1420. Dimensions are 40 x 11 x 11" .....**63.50**

#### Large Stand Sack (LIC6150)

An economical transportation of stands, light banks, umbrellas, tripods and other location materials. Adjustable straps allow you to sling it over your shoulder, wear it on your back, or simply hand carry it. A structural end panel prevents stand or tripod legs from puncturing the fabric. 50 x 18.5" .....**58.95**

#### Medium Stand Sack (LIC6140)

39 x 14" .....**49.95**

#### Small Stand Sack (LIC6130)

30 x 11.75" .....**41.95**

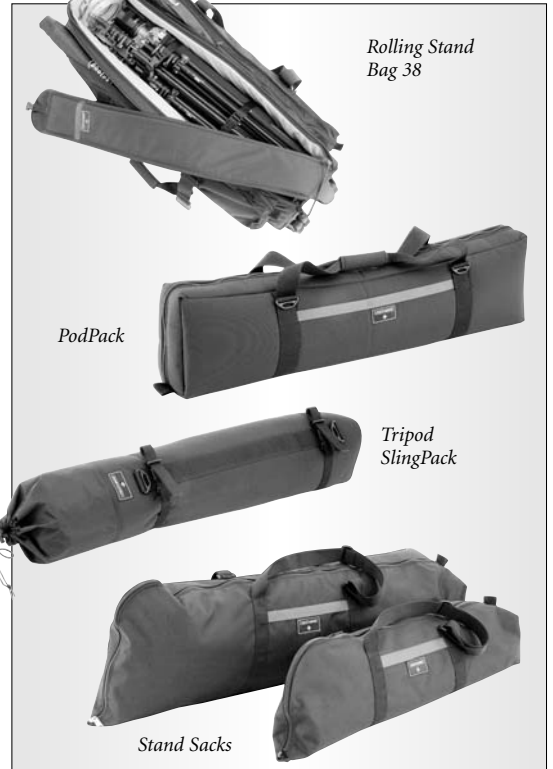

Rolling Stand Bag 38

PodPack

Tripod SlingPack

Stand Sacks

### STROBE HEAD CASES



Speedpack Case (S1010)

Four Head Strobe Case (T4444)

Strobe Head Case (T3040)

#### Speedpack Case (LIS1010)

Fits a Speedotron 812, 1205, 2401B, 2403, or 2405 power pack. It will also hold a Bronclor Pulso 2 or 4 power supply or two Bowen Monolights. Built with a rigid lightweight interior that is covered with shock absorbent foam and padded tricot, the Speedpack Case has an exterior shell of puncture and abrasion resistant ballistic nylon that offers superior strength, shock absorption and insulative protection. 17.5 x 12 x 19.25" .....**276.95**

#### Four Head Strobe Case (LIT4444)

Designed to hold and protect 4 strobe heads, the ballistic nylon T4444 can also accommodate 4 Speedotron 102 heads, a variety of the Calumet Travelite systems or 4-5 White Lightnings, 2 Dyna-Lite M2000x packs and 4 heads plus accessories, 4 Elinchrom T heads or even a Hasselblad projector and accessories. Three dividers allow you to adjust for your needs. Dimensions are 31 x 11 x 18" .....**372.95**

#### Strobe Head Case (LIT3040)

With its flat dividers, the Strobe Head Case holds 3 large flash heads such as Elinchroms, Speedotrons or Bronclors. It works for several small heads like 6 Comet CX series heads plus accessories, or 9 Norman flash heads. Dimensions are 24.5 x 11.5 x 18" .....**312.95**



# LIGHTWARE

## EQUIPMENT CASES & CASE PROTECTORS

### VIEW CAMERA CASES



View Camera Case

#### View Camera Case (LIV4000)

Ideal for the Sinar F, F1 and F2 view cameras. Similar to the Strobe Head Case, the V4000 features moveable dividers that are notched for a camera rail and can be shortened in height. It will also accommodate an abundance of film, film holders and accessories, or a head pouch filled with additional lenses and accessories. 24 x 11.5 x 18".....312.95

#### Power View Camera Case (LIV4300)

This larger version of the View Camera Case holds larger cameras like a Sinar P2, Horseman LX, Cambo Legend, Linhoff or Arca Swiss and all similar monorail or off-axis 4x5 view cameras. Dimensions are 27 x 15 x 21".....427.95

#### Multi View Camera Case (LIV4001)

For the serious location photographer. It fits most 4x5 camera. A "cradle" box holds the camera rail securely in place. The compartments on either side can be filled with extra lenses and accessories. Additional dividers cushion smaller sized cameras. 27 x 17.5 x 21" .....482.95

### UGLY COVERS

*Designed for extra protection, these rugged covers zip around your aluminum cases to protect them from the grime and scratches of travel. You can mark them up and personalize them to your taste - stencil and spray paint work wonders. "Camo" paint can really add a special personal touch. If you are on an adventure, you can number each one so you know quickly what's here and what's missing.*



#### Large Ugly Cover (LIUCL)

26 x 9 x 18". It fits over the MF1623.....74.95

#### Medium Ugly Cover (LIUCM)

21 x 7 x 17.5". It fits over the MF1420...68.50

#### Small Ugly Cover (LIUCS)

21 x 6.5 x 13". It fits over the MF2012...59.95

### SOFT SIDES

*Carry your equipment in the luxury of an extra lightweight case. Great for the photographer who does not necessarily need the protection of Lightware's standard cases and either carries equipment on board an airplane, or just travels "around town". Made of .5" Duralight, the unique design allows unzipping the case to lie completely flat to be used as a work surface, or can be folded flat for compact storage.*

#### Deluxe Soft Side Kit Case (LIZ5060)

Perfect for 2 Dyna-Lite M100x packs, 3 heads, and accessories or a similar system. Padded dividers keep heads separate and a shelf divider is provided for stands and umbrellas. 32 x 8 x 13" .....224.95

#### Compact Soft Side Case (LIZ5030)

Ideal for either a Lumedyne System or Dyna-Lite 500M or 1000 power supply and a few flash heads as well. 15 x 9.5 x 11.5".....125.95

#### Mid Size Soft Side Case (LIZ5020)

Fits a Dyna-Lite 2000x with 2 heads or two Lumedyne power supplies, flash heads, reflectors & accessories. 18 x 8 x 11.5" ...125.95



Deluxe Soft Side Kit Case

Uni Kit Case

#### Speedpack Soft Side Case (LIZ5010)

It fits a Speedotron 1201A, 2401A or 4801A power supply. Can also fit a 2403B with additional 9 x 9 foam inserts. Can also be used for a Broncolor Pulso 2 or 4 power supply. Pack a bunch of Lowell Tota Lights, four White Lightning Ultras or two Bowen Monolights. 16 x 10 x 15.5" .....125.95

#### Uni Kit Case (LIZ5200)

A soft-sided compact case for Dyna-Lite Uni Kit or similar system. Padded dividers keep heads separate and a shelf divider is provided for stands and umbrellas. 23 x 8.5 x 15.5" .....167.95

ORDER & INFO. (212) 502-6340 • FAX: (212) 239-7770 (800) 947-7008  
1-800-290-6750 • www.bhphotovideo.com



BAGS

555

# LIGHTWARE

## POUCHES & LENS CASES

BAGS

556

### HEAD POUCHES

Designed to be used in conjunction with Cargo and View Camera Cases. They can be hand carried or worn over the shoulder if fitted with a Lightware Shoulder Strap. Head Pouches are made from 1/2" Duralight closed-cell foam. Using your creative powers, you can find many uses for these lightweight and versatile pouches.



#### Large Head Pouch (LIH7020)

Ideal for larger flash heads like Speedotron, Broncolor, or Elinchrom. It can fit two fan-cooled Norman LH2000 flash heads, or a Dynalite M500 power supply. It will accommodate twenty six 4 x 5 film holders. 14 x 8 x 8" .....79.50

#### Small Head Pouch (LIH7010)

Holds ten 4x5 film holders and small accessories. Can accommodate two to three view camera lenses mounted on 5 x 5" or smaller lens boards. Ideal for carrying smaller flash heads, 35mm equipment or on-camera type flashes. Dimensions are 10 x 6 x 6" .....65.95

### RAIN COVER / LONG LENS CASES

#### Long Lens Cases

A zippered flip lid has a detachable interior zippered "Trap Pack" pocket for a camera body, film, or accessories. Take out the Trap Pack and there's enough room to place the lens with the camera body attached into the case. A quick release fastax buckle allows the lid to be closed without having to zip it up. The Long lens case comes with a permanent adjustable shoulder strap; adjustable exterior straps for a monopod; exterior pockets on 3 sides for press passes, pens, pencils and important papers, or an optional detachable "Z" Pocket. (Each case will accommodate up to 3 pockets).

#### Long Lens 600 Case (LIZ600)

Designed to fit Nikon, Canon and 500 and 600mm f/4 lenses. Dimensions are 9.5 x 9.75 x 23" .....167.95

#### Long Lens 400 Case (LIZ400)

Designed to fit the Nikon, Canon and other 400mm 2.8 lenses. Dimensions are 9 x 9 x 18.5" .....155.95

#### Long Lens 300 Case (LIZ300)

Designed to fit the Nikon, Canon and other 300mm 2.8 Lenses. Dimensions are 7.5 x 8 x 15" .....143.95



#### Lens Shipping Cases

Ship your long lenses with security, knowing they will arrive safely. It also works well if you need to mix and match lots of extra bodies and lenses for setting up projects. If you prefer to double pack your lenses, you can first put them into either a Long Lens 600, 400 or 300 Case, and then into the Long Lens Shipping Case. When you arrive at your destination, simply take the soft case out and leave the shipping case in your hotel room.

#### Long Lens Shipping Case (LIZ1328)

This case will hold two lenses up to a 600mm f/4. 26 x 12.5 x 21.5" .....395.95

#### Half Height Long Lens Shipping Case (LIZ1309)

This case will hold one lens up to a 600mm F/4. 26 x 12.5 x 13" .....352.95



#### Rain Cover (LIRC100)

This very sleek nylon rain cover will keep your cameras with 300 to 600mm lenses dry in rainy or snowy weather. It is comfortable to work under and will help to keep your own head dry. 39.5 x 24.5" .....29.95



# LIGHTWARE

## ACCESSORIES

### A C C E S S O R I E S

#### Large Mongo Shipping Tag (LIMTL)

A large tag to help you find your luggage easily, or hold an airbill so you can ship your cases ahead. The front window won't crack in cold weather. 12 x 8.5 x .25" .....**23.95**

#### Mini Mongo Shipping Tag (LIA2011)

ID your bags easily. Keep track of flying inventory, or use it to mark your bags. Dimensions are 7.5 x 6.25 x .25" .....**19.95**

#### 6" Cinch Locks (LICL6)

A set of six 6" elastic slip cords that securely bind and hang a variety of items .....**14.95**

#### 8" Cinch Locks (LICL8)

Same as above, but 8" .....**14.95**

#### 10" Cinch Locks (LICL10)

Same as above, but 10" .....**14.95**

#### 12" Cinch Locks (LICL12)

Same as above, but 12" .....**14.95**

#### Pod Locks (LIA2030)

Holds your stand legs or background poles together with an elastic cord and clip hook design. Simply attach the looped end to one of the tripod legs to anchor around all three legs and clip the ends together.....**14.50**

#### Bandelero Shoulder Strap (LISSB)

A super wide shoulder strap that provides extra comfort for heavy loads. It accommodates up to 3 GripStrip pouches. Adjustable from 32" to 50" .....**45.95**

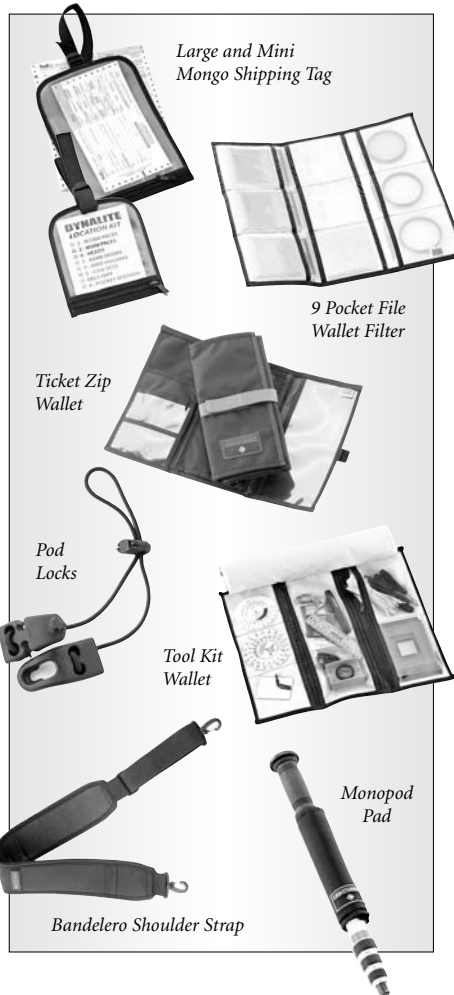

#### 9 Pocket File Wallet Filter (LIFW9)

Designed to hold filters, computer disks, cable releases and other similar items. Each pocket is lined with a special plastic for easy viewing. 14.5 x 16.5 x .25" .....**38.95**

#### 6 Pocket File Wallet Filter (LIFW6)

Designed to hold filters, computer disks, cable releases and other similar items. Each pocket is lined with a special plastic for easy viewing. 13.5 x 5.5 x .5" .....**34.95**

#### Ticket Zip Wallet (LITZ)

A tri-fold travel wallet designed to hold all important travel necessities. Comes with pockets. Great for credit cards, passports, money, airline tickets, foreign currency and business cards. 13.5 x 5.5 x .5" .....**62.95**

#### Tool Kit Wallet (LIA8700)

A simple, efficient place to put all the little tools you need when we travel. Fix the PC sync, tighten the screw, glue the gizmo on, cut the cable, tape the connection, check the voltage, scrap the battery or wedge it off. 13.5 x 16.5 x .25" .....**49.95**

#### Master Lock (LIML)

A Master Lock that fits perfectly through Lightware's interlocking slider pulls.....**5.95**

#### Monopod Pad (LIMP100)

The Monopod Pad wraps around a monopod and closes tight with a hook and loop. 9 x 8.5 x .25" .....**9.95**

### D I V I D E R S

#### 1420 Divider Set (AD8020)

Fits all MF1420 cases or any Hook and Loop compatible case (2 dividers, 12 hooks). Dimensions are 19.5 x 5 x .5" .....**CALL**

#### 1420 Divider Set (LIDKDMF)

Fits all MF1420 cases or any Hook and Loop compatible case (5 dividers, 24 hooks). Dimensions are 19.5 x 5 x .5" .....**52.95**

#### 1623 Divider Set (LIA1623)

Fits all MF1623 cases or any Hook and Loop compatible case (4 dividers, 16 hooks). Dimensions are 22.5 x 15.5 x 7.5" .....**65.95**



#### 1629 Divider Set (LIA1629)

Fits all MF1629 cases or any Hook and Loop compatible case (3 dividers, 12 hooks). Dimensions are 28.5 x .5 x 9.5" .....**79.95**

#### Power Kit Divider (LIA1800)

Divider for Power Kit 1800. 18 x 7" .....**19.95**

#### Power Kit Divider (LIA1600)

Divider for Power Kit 1600. 16 x 7" .....**19.95**

#### Power Kit Divider (LIA1400)

Divider for Power Kit 1400. 14 x 7" .....**19.95**

#### Power Kit Divider (LIA1200)

Divider for Power Kit 1200. 12 x 7" .....**19.95**

ORDER & INFO. (212) 502-6340 • FAX: (212) 239-7770 (800) 947-7008  
**1-800-290-6750 • www.bhphotovideo.com**



# LIGHTWARE

## GRIPSTRIP SYSTEM

BAGS

558

If you've ever been in places where you just can't set your equipment down or if you've tried jogging with your forty pound camera bag over your shoulder, then you are going to appreciate the GripStrip Belt System. This system has uniquely designed pouches for film and Polaroid backs, small flashes, meters, lenses, tools, camera bodies, videotape or exposed film, cell phones, two way radios and a whole lot more. Attach them to your belt, or clip up to 5 pouches on the GS4000 Padded Grip Belt.

### GripStrip Starter Kit (LIGSSSK)

Consists of the GS4000 Padded Grip Belt, GS300 Small Pouch, GS3000 Raw Film Pouch and the GS401 Exposed Film Pouch ....**117.50**

### Padded Grip Belt (LIGBP)

A padded, fully adjustable belt that holds up to five GripStrip pouches. It has a quick release buckle, swivel clips and D-rings that allow you to attach accessories or equipment. 33-55 x 4" .....**49.95**

### Trim Grip Belt (LIGBT)

A slim version of the Padded Grip Belt. As a matter of personal choice, you can use the full padded version or you can go lighter while on the beach. 33-55 x 2.25" .....**33.50**

### Extension Belt (LIEB)

When you need a little more length to your Padded Grip Belt. 13.5 x 2" .....**9.95**

### Travel Belt (LITB)

A wrap-around travel belt with compartments for cash, credit cards, airline tickets and more. 10 x 1 x 6" .....**44.95**

### Small Fleece Storage Pouch (LIPFSS)

Soft easy storage for film backs, lenses, film, meters, etc. 3.5 x 3.5 x 7.25" .....**19.95**

### Medium Fleece Storage Pouch (LIPFSM)

4 x 4 x 9.25" .....**24.95**

### Large Fleece Storage Pouch (LIPFSL)

4.5 x 4.5 x 12" .....**28.95**

### Extra Large Fleece Storage Pouch (LIPFSLXL)

8 x 7 x 15" .....**33.50**

### Small Padded Lens Pouch (LIPPS)

3.5 x 2.75 x 5.5" .....**39.50**

### Medium Padded Lens Pouch (LIPPM)

4 x 3 x 8" .....**44.50**

### Large Padded Lens Pouch (LIPPL)

4.5 x 3.5 x 9" .....**47.95**

### Small Meter Case (LIMCS)

Designed for small light meters, cell phones, small binoculars, or a PDA. Quick release buckle closure. 3.5 x 2.5 x 6.25" .....**24.95**

### Medium Meter Case (LIMCM)

For larger light meters, flashes, small battery packs, cellphones, etc. 3.5 x 2.5 x 7.75" .....**26.50**

### Wide Meter Case (LIMCW)

Designed for tri-meters, wireless mics, Quantum sized battery packs, binoculars, or 4x5 roll film backs. 4.75 x 2.5 x 7.75" .....**33.50**

### Film Back Pouch (LIPFB)

Designed to hold medium format film backs. It will also hold a Leica M6 or Contax G2 camera. 5 x 2.5 x 6.25" .....**24.95**

### Water Bottle (LIWB)

Holds a water bottle. 3.75 x 2.5 x 6.5" .....**22.95**

### Polaroid 545 Back Pouch (LIPFBP545)

Holds a 4x5 Polaroid back or Ready Loads. 5.5 x 1.5 x 7" .....**33.50**

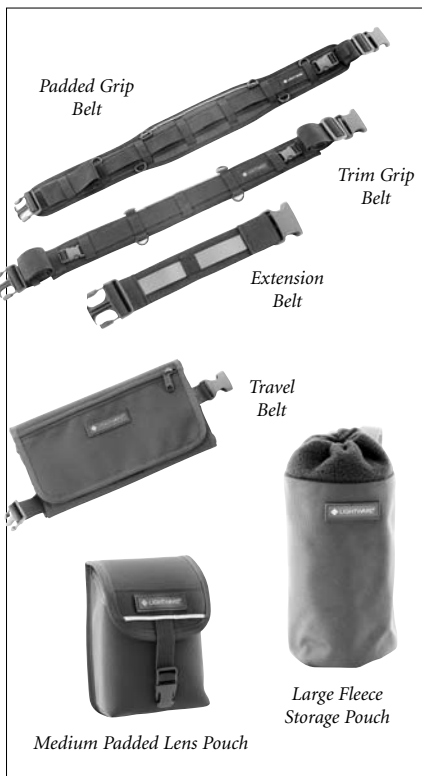

### Multi Polaroid Back Pouch (LIPPFBM)

Holds medium and 35mm format Polaroid backs. It has two pen holders, a hook and loop patch for a small pocket timer, and a front mesh pocket for exposed Polaroids. 4.5 x 1.5 x 4.25" .....**33.50**

### Press Pass Deluxe (LIPPD)

Designed to hold press credentials, this pouch holds a journalist's pocket notepad. There are inside pockets for pens, business cards, a small tape recorder or a PalmPilot. Hook and loop closure. 5.5 x 1 x 6.75" .....**35.95**

### Press Credential Holder (LIPC)

A window pocket pouch for press credentials with a pen holder, and numerous pockets for business cards, calculators, note pad or a small tape recorder. 5.5 x 2.5 x 9.25" .....**16.95**

### Filter/CD Pouch with Pocket Set (LIPFZ)

A flip file style pouch for 4x4" or 4x5" filters, CDs or Zip disks in removable pocket sets. Each GS900 comes with one pocket set but can hold up to four pocket sets. Hook and loop closure. 5.5 x 1 x 6.5" .....**38.50**



**ONE HOUR FREE PARKING**  
AT 349 W. 34th STREET (with purchase of \$100 or more)

# LIGHTWARE

## GRIPSTRIP SYSTEM

### Pullout Filter Pocket (LIPFY)

Additional inserts for the GS900 .....**12.95**

### Arca Masking Kit (LIMKAS)

Shoot to a specific proportion by masking your ground glass. Just a little "funtak" holds these in place. 9 sizes. 5.75 x .5 x 6.25" ...**41.95**

### Cambo Masking Kit (LIMKC)

For Cambo. 9 sizes. 5.75 x .5 x 6.25" .....**41.95**

### Sinar Masking Kit (LIMKS)

For Sinar. 9 sizes. 5.75 x .5 x 6.25" .....**41.95**

### Camera Body Pouch (LIPB)

A great place to store an extra camera body or your color calibrating gear. It fits in any Multi Format case without dividers. It also has two "D" rings for attaching a shoulder strap and a standard belt/loop and loop attachment. 6.5 x 3 x 6.75" .....**44.95**

### Padded Grip Bag (LIGBPQ)

A cozy little case that holds a camera body, a flash, a small lens, extra batteries, a cable release, cleaner and five rolls of film. It has 5 interior pockets, a removable center divider, and an outside zippered pocket. It comes with a carrying handle and shoulder strap. 6.5 x 3.25 x 6" .....**63.50**

### Unpadded Grip Bag (LIGB)

If you need to walk around for the day and want to take a camera along with other necessities, this one does the job. Numerous interior pockets. 6.5 x 3.25 x 6" .....**49.95**

### Deluxe Gaffer Bag (LIGBD)

A great tool bag with a carry handle and a fold over flap. It has numerous interior pockets, an exterior loop for a flashlight or a hammer, and a handy exterior tab with a carabiner for hanging electrical tape or other similar items. 6.5 x 2.5 x 8" .....**58.95**

### Half Gaffer Bag (LIGBH)

A smaller version of the Deluxe Gaffer Bag. You can fit all of your electrical essentials for working on the set. Perfect when you have tuned your tools to be just what you need and nothing more. x 2.5 x 8" .....**38.50**

### Tool Mate (LITM)

A great little pouch for items like a mini maglite, laser pointer, super tool, pocket knife, etc. 4 x .5 x 6.5" .....**18.95**

### Raw Film Pouch (LIFPQ)

A working pouch for raw 35mm and 120 film. It has a draw string closure, and three interior pockets to hold small accessories. It adapts well to your needs. 4 x 3.5 x 7" ...**24.95**

### Neoprene Shoulder Strap (LISSN)

A padded neoprene shoulder strap for pouches that accept shoulder straps .....**19.95**

### Small Flat Stash Pouch (LIPFSSQ)

Lined with soft polar fleece this stash pouch is great for small "flat" stuff such as compact hard drives, MP3s, zip disks or even a stash of DVD's. 6 x 6" .....**19.95**



### Medium Flat Stash Pouch (LIPFSMQ)

For bigger "flat" stuff, like desk-sized hard drives, coiled connection cables or even more DVD's. 8 x 8" .....**22.95**

### Large Flat Stash Pouch (LIPFSLQ)

Fits a small point and shoot camera, fresnel lenses, Zip drives and disks, or similar sized items. 10 x 10" .....**24.95**

### Zippered Flat Stash Pouch (LIZSP)

Lined with tricot, this zippered pouch is a great place to keep track of little accessories or adapters. 7 x 1 x 7.5" .....**24.95**

### Cell Phone Pouch (LIGS7010)

A dual pocket pouch that will hold a cell phone in one pocket and items like a PalmPilot in the other. Has a pocket for business cards and side mesh pockets for pens or markers. 3.25 x 2.25 x 6" .....**19.95**

BAGS

559

## ACCESSORY POCKETS



Large Multi Z Pocket (Z0192)

Mini Briefcase (Z0192)

### Z Pocket (LIZ100)

An attachable and detachable padded camera pocket that fits most 35mm camera bodies with motor drives. It attaches to all Long Lens Cases, BP1420 Backpack, Lightwalker LW1422, and the MF912, MF1217, and MF1420. Dimensions are 7.3 x 3.5 x 8.5" .....**65.95**

### Small Multi Z Pocket (LIZ0191)

An attachable and detachable briefcase for the Backpack BP1420, MultiFormat MF912, MF1015, MF1217 and MF2012. Outside pockets hold airline tickets and a magazine. An inside net pouch clips in and out. Places for notes, CDs, pens and pencils, etc. 13.25 x 3 x 11" .....**102.95**

### Large Multi Z Pocket (LIZ1412)

A larger version of the Z1091. Stuff it full of magazines, a handful of CDs and all your travel necessities in the detachable pocket. Room for a PDA, GPS, iPod and a great deal more. Fits the MultiFormat MF1420. Dimensions are 18 x 3 x 13" .....**122.50**

### Mini Briefcase (LIZ0192)

A great little "Directors" bag. Just enough room for the days script and necessities. Interior pockets allow you to organize all your pens, pencils, PDA etc. A detachable pocket allows you to throw in all your loose stuff without a worry. 13.25 x 3 x 11" .....**102.95**

ORDER & INFO. (212) 502-6340 • FAX: (212) 239-7770 (800) 947-7008  
1-800-290-6750 • www.bhphotovideo.com





# LOWEPRO

## ADVENTURER SERIES BACKPACKS

BAGS

560



The Adventurer Series Trekker backpacks feature a fully adjustable harness, CollarCut straps, load adjustment straps and a contoured, padded waistbelt to distribute the load. Created from water-resistant 600D ripstop nylon and 600D Endura nylon, they have a customizable interior, water-resistant quick-access YKK zippers, a patented All-Weather Cover and attachment loops that accept optional SlipLock accessories and let you position them wherever they are most convenient. You can position the quick-release Tripod Mount on either side or down the center of the pack. The vertical position balances the weight for difficult terrain.

### Super Trekker AW II (LOSTAW2B)

Featuring an improved harness system which includes an adjustable expedition-quality harness with an internal frame, the Super Trekker AW II has a fully customizable interior, and three included accessories (Trekker DayPack, Trekker Lens Pouch and Trekker Accessory Pouch). It holds 2–3 pro SLRs (including the Nikon F5), 7–9 lenses up to 800mm, tripod, flash and accessories. Exterior dimensions with the tripod holder attached is 23.5 x 15 x 27.5" (WDH).....**389.95**

### Pro Trekker AW II (LOPTAW2B)

Similar to the Super Trekker AW II, the Pro Trekker AW II features an internal frame and DryFlo mesh padding. The interior is fully customizable for any system. The Pro Trekker AW II includes the Trekker DayPack, Trekker Lens Pouch and Trekker Accessory Pouch accessories. It can hold 2 large pro SLRs (including the largest professional 35mm or digital SLRs, like the Nikon F5), and 6–7 lenses up to a 600mm f/4.0. Exterior dimensions with the tripod holder attached is 21 x 15 x 23.5" (WDH).....**319.95**

### Photo Trekker AW II (LOTAW2B)

For outdoor photographers and extreme sports shooters, this roomy backpack can be customized for a variety of equipment. It includes the Trekker DayPack accessory which fastens to the front of the Trekker. It can hold 1–2 large 35mm or digital pro SLRs with lenses attached, plus 5–7 more lenses (up to a 400mm f/2.8). Exterior dimensions with the tripod holder attached is 14.5 x 15 x 21.5" (WDH).....**229.95**

### Nature Trekker AW II (LONTAW2B)

A hardworking backpack that can be customized for many systems. It includes a Trekker DayPack accessory for extra storage capacity. It holds a large 35mm or digital pro SLR; 4–5 lenses (up to a 400mm f/2.8); flash and accessories. Exterior dimensions with the tripod holder attached is 14.5 x 15 x 19" (WDH).....**189.95**

| Capabilities         | Large Format | Medium Format | Pro 35mm SLR | Digital Camera | Airline Carry-on | SlipLock system | AW Cover |
|----------------------|--------------|---------------|--------------|----------------|------------------|-----------------|----------|
| Super Trekker AW II  | •            | •             | •            | •              |                  | •               | •        |
| Pro Trekker AW II    | •            | •             | •            | •              | •                | •               | •        |
| Photo Trekker AW II  | •            | •             | •            | •              | •                | •               | •        |
| Nature Trekker AW II | •            | •             | •            | •              | •                | •               | •        |



For Any Inquiries Regarding Your Order, Call Our Customer Service:  
 (800) 221-5743 • (212) 239-7765 • FAX: (800) 947-2215 • (212) 239-7549

# LOWEPRO

## ADVENTURER SERIES BACKPACKS

### DryZone Waterproof Backpacks

DryZone is the world's first totally waterproof, soft-sided camera backpack. Even fully loaded, it floats, so your gear is always protected. It has a hi-tech zipper that you can close for watertight protection. When you're away from water, sand or snow, you can fasten an inner zipper and top clip, and leave the zipper open for faster, easier access to your equipment. Inside the DryZone is a heavy-duty camera compartment, completely customizable for a variety of systems. Wrapping it all up is the backpack, which includes a tuck-away tripod holder, two self-draining outer mesh pockets, generous inner mesh pockets, a drain hole for the pack, an ergonomic, fully adjustable backpack harness, rubber handle and attachment loops for SlipLock add-ons on the padded waistbelt and the contoured shoulder straps.

#### DryZone 100

Accepts a pro SLR; 4-6 lenses (80-200mm f/2.8); flash and accessories; Size (Interior): 11W x 5.5D x 15H"; (Exterior): 12.5W x 8D x 17.5". Available in Gray (LOD100G) and Yellow (LOD100Y) colors .....**210.95**

#### DryZone 200

Accepts a pro SLR; 4-5 lenses (up to a 300mm f/2.8, with hood reversed); flash and accessories; Size (Interior): 12W x 6D x 17H"; (Exterior): 14.5 x 11.5 x 19" (WHD). Available in Gray (LOD200G) and Yellow (LOD200Y) colors .....**234.95**



DryZone 100



DryZone 200

BAGS

561

### Road Runner Backpacks

The water-resistant 600D ripstop nylon and 2000D ballistic nylon Road Runner rolling backpacks have a harness opposite the wheel and handle system, so the rolling frame doesn't dig into you. The expedition-quality backpack harness has an internal frame, ergonomic waistbelt and removable CollarCut shoulder straps. They both include a removable All Weather Cover and a customizable removable insert that allows you to use the backpack as a rolling travel bag. Attachment loops take optional SlipLock add-ons.



Road Runner AW



Road Runner Mini AW

#### Road Runner AW (LORRB)

A rolling backpack with a removable CollarCut harness (adjustable for torso length). Includes a removable DayPack; a Tripod Mount; and integrated travel cover for harness and waistbelt. It holds a 35mm pro SLR system with 6-7 lenses (up to 600mm f/4). Dimensions are 14 x 1 x 23" (WDH) .....**425.95**

#### Road Runner Mini AW (LORRMB)

Substantially lighter than the Road Runner AW, with a DryFlo meshlined padding. Construction is tough, with screws, not rivets. Generous pockets store personal extras. It can hold a large 35mm or digital pro SLR with 4-5 lenses (up to a 400mm f/2.8); flash and accessories. Dimensions are 1 x 12 x 20" (WDH) .....**289.95**

ORDER & INFO. (212) 502-6340 • FAX: (212) 239-7770 (800) 947-7008  
**1-800-290-6750 • www.bhphotovideo.com**



# LOWEPRO

## ADVENTURER SERIES BACKPACKS

BAGS

562

### **Lens Trekker 600 AW** (LOLT600AW)

The water-resistant Lens Trekker 600 AW features a fully adjustable built-in backpack harness that includes a padded back pad with lumbar support, padded CollarCut straps, an All Weather Cover, lens stabilizer, lens collar and a padded waistbelt. Attachment loops on the shoulder straps take optional SlipLock add-ons. It accepts a large pro SLR with lenses from 300mm f/2.8 to 600mm f/4 (attached) or up to 800mm (without body attached), plus lens hood and tripod collar; or a pro SLR with 2 shorter lenses and accessories. It's exterior dimensions are 11 x 12.5 x 22" (WDH) .....**129.95**

### **Orion Trekker II**

This two-compartment backpack easily carries and protects camera gear, plus snacks, clothing or personal items. It has a padded contoured shoulder harness, detachable waistbelt, and mesh-covered back pad. It accepts an SLR with attached zoom, 2-3 more lenses, flash or compact binoculars plus accessories. A removable camera insert allows this backpack to be used as a standard full daypack. The top compartment interior is 11.8 x 6.9 x 10.4". The bottom compartment interior is 11 x 6.5 x 6.3". Available in Black/Red (LOOT2R) and Black/Silver (LOOT2BQ) colors .....**60.95**

### **Rover AW II** (LORAW2)

A two-compartment backpack with an adjustable, padded, built-in backpack harness that includes CollarCut shoulder straps, a sternum strap, waistbelt, and load-adjustment straps. Attachment loops on the harness and waistbelt accept optional SlipLock add-ons. Camera gear stows in the bottom compartment, while extras can go in the top compartment. The center divider folds away to create a single compartment. It includes a pull-out tripod holder and mesh side pockets. It holds a large pro SLR with 80-200mm f/2.8 lens attached, additional lenses and accessories. Top compartment size (interior): 11 x 5.5 x 11" (WDH). Bottom compartment size (interior): 11 x 5.5 x 10" (WDH).....**115.95**

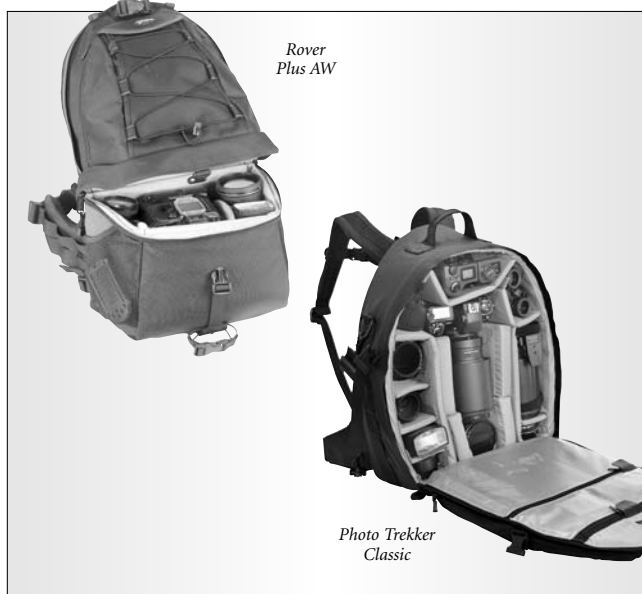

### **Rover Plus AW** (LORPAWB)

The Rover Plus AW's size and fully featured versatile two-compartment design lets you consolidate your gear including cameras, clothing, food and water in one pack. The padded bottom holds a large pro SLR with an 80-200mm f/2.8 lens attached, plus other lenses and accessories. A fully adjustable Harness and Waistbelt system offers superior comfort and an ergonomic fit for long hikes and heavy loads. CollarCut straps, sternum and load adjustment straps eases stress. The Rover Plus AW features offers water-resistant protection, an All Weather Cover and SlipLock attachment loops. 11 x 5.5 x 11" top compartment interior; 11 x 5.5 x 10" bottom compartment interior .....**149.95**

### **Photo Trekker Classic** (LOTGR)

The original Lowepro lightweight photo backpack features an ergonomic harness with CollarCut straps, a sternum strap, padded waistbelt and foam backpad on the lumbar support. The harness can be tucked away when not in use. There's a customizable interior, multiple pockets, a water-resistant outer fabric, a detachable shoulder strap, handgrip and bottom straps for a jacket or light tripod. It accepts a pro SLR and 5-7 lenses (including a 400mm f/2.8 lens). Dimensions are 14 x 13 x 20" (WDH). Forest Green color.....**152.95**



**EQUIPMENT LEASING AVAILABLE**

# LOWEPRO

## ADVENTURER SERIES BACKPACKS

BAGS

563



### Rolling Mini Trekker AW (LORMTAW)

The first of its kind, this super lightweight rolling backpack is the most versatile carry-on sized photo pack ever. It has sealed-bearing in-line skate wheels and an extendable, single-handle tube system that's curved to provide perfect balance and roll effortlessly over most surfaces. It easily converts to a backpack with an ergonomic harness and padded waistbelt that tuck neatly away when using the roller system. A fully customizable interior with adjustable shock-absorbing padded dividers protects your gear while the built-in All Weather Cover keeps the entire pack safe from the elements. As with all Trekker backpacks, the Rolling Mini Trekker AW comes with a hide-away tripod holder and SlipLock attachment loops. It holds an SLR with a 80-200mm f/2.8 lens attached, an additional SLR body, 3-5 lenses and accessories. The interior is 11½ x 5½ x 15¼". Black color.....179.95

### Mini Trekker AW

With an outer fabric of water-resistant 600D TXP and 600D TXP ripstop, the ever-popular Mini Trekker has been upgraded to include an All Weather Cover. This lightweight, compact backpack holds a surprising amount of gear in a small space. There's a quick-release integrated tripod holder, SlipLock attachment loops, compression straps and lots of pockets — including a large front pocket with a weather flap and quick-access front pocket. The ergonomic harness features wide padded shoulder straps and a sternum strap. It can hold an SLR with an attached 80–200mm f/2.8 lens (most makes), an additional body plus 4–5 more lenses. Exterior dimensions are 12 x 12.5 x 16" (WDH). Available in Black (LOMTAWB) and Forest Green (LOMTAWGR) colors .....110.95



### Mini Trekker Classic (LOMTCB)

There's a reason they call this a classic — the Mini Trekker Classic has sailed through the test of time and terrain. A favorite of amateurs and pros alike, the Mini Trekker Classic stands up well to heavy use in the field and still looks good. This go-everywhere light backpack has a flexible interior and comfortable, carry-all-day harness. Attachment loops take optional SlipLock add-ons. It can hold an SLR with an attached 80–200mm f/2.8 lens (most makes), an additional body plus 4–5 more lenses. Exterior dimensions are 12 x 12.5 x 16" (WDH).....79.95

### Micro Trekker 200

This water-resistant, compact and functional camera backpack has a large front pocket with internal organizer pockets, expandable side pockets, laminated mesh pockets, wide shoulder straps, sternum strap, a removable waistbelt and two attachment loops for optional SlipLock add-ons. Removable bottom straps take a small tripod or a windbreaker. It holds an SLR with an attached 80–200mm f/2.8 lens (most makes) plus three more lenses or an additional body or a flash. Its exterior dimensions are 11 x 8.5 x 14H" (WDH). Available in Black (LOMT200B), Forest Green (LOMT200GR) and Red (LOMT200R) colors .....59.95



**Micro Trekker 100:** Same as above, but slightly smaller. It holds an SLR plus 2-3 extra lenses or a flash or an additional camera body. 10.5 x 8 x 11.5" (WDH). Available in Black (LOMT100B), Forest Green (LOMT100GR) and Red (LOMT100R) ....44.95

### Specialist 85 AW (LOS85AW)

An ergonomic shoulder bag/beltback for photographers who need instant access to a large pro SLR with attached lens. This hardworking bag has a fully customizable interior, mesh pockets, a NoDrop Pocket for film and filter changes, an All Weather Cover, metal D-rings and a reverse-open lid. It comes with a padded shoulder strap and a built-in waistbelt for stability and carrying comfort. For more support, add an optional S&F Shoulder Harness or S&F Vest Harness. The Specialist 85 AW holds 1–2 large pro SLR bodies (including the Nikon F5) 3–5 lenses, including an attached 80–200mm f/2.8 lens. Its interior dimensions are 11 x 6.5 x 12" (WDH) .....107.95

ORDER & INFO. (212) 502-6340 • FAX: (212) 239-7770 (800) 947-7008  
1-800-290-6750 • www.bhphotovideo.com



# LOWEPRO

## ADVENTURER SERIES BELTPACKS

BAGS

564



### Highlights of the Orion Series



A reverse-open lid helps you access equipment in tight spaces



When the going gets tough, BatWing compression straps keep everything secure

### Orion AW

An award-winning, water-resistant convertible beltpack/backpack, the Orion AW is designed for heavy professional use. It includes an All Weather Cover; a tripod attachment system; a customizable interior; a reverse-open lid; a removable contoured shoulder strap; and a detachable daypack. While using as a beltpack you can swing the Orion AW around for instant access to gear. A DryFlo mesh covered lumbar pad and compression straps provide comfort for heavy loads. It holds a large pro SLR with 80–200mm f/2.8 lens (most makes, not attached), 3–4 additional lenses, flash, compact binoculars and accessories. The interior of the Daypack is 12.5 x 6.5 x 11.25" (WDH), the Beltpack size is 12.5 x 7 x 9" (WDH). The combined Daypack/Beltpack exterior is 14.5 x 9.5 x 21.25" (WDH). Available in Black (LOOAWB) and Forest Green (LOOAWGR) colors.....**122.95**

### Orion

A streamlined water-resistant 600D TXP and 600D TXP ripstop beltpack that hugs your body for comfort, stability and freedom to move. Carry the Orion with or without the removable shoulder strap. The ergonomic design includes many features to keep you comfortable and stabilize your load on uneven trails. There's a fully customizable interior, lots of pockets (including mesh side pockets) and a reverse open lid for fast and easy access to gear. Capacity: SLR, 3–4 lenses, flash and accessories. The interior size is: 11.5 x 6 x 6.5" (WDH). Available in Black (LOOB) and Forest Green (LOOGR) colors.....**46.95**

**Orion Mini:** Similar to the Orion, but a bit smaller. It holds an SLR and 1–2 lenses. 7.5 x 5 x 6" (WDH). Available in Black (LOOMB) and Forest Green (LOOMGR) colors.....**31.95**

### Off Road (LOORBQ)

It's versatile, convertible and modular — this beltpack/shoulder bag comes with two removable SlipLock cases. You can add or subtract lenses, water bottles or optional SlipLock add-ons. The adjustable, curved shoulder strap adds support. Includes a DryFlo mesh lumbar pad, laminated mesh pockets, compression straps and a NoDrop Pocket for film and filter changes. It holds an SLR with attached lens, 3–4 lenses or 1–2 lenses and water bottle, flash, accessories. The main compartment interior is 8 x 4.5 x 8" (WDH); the lens case interior is 3.25 x 7.75" (DH) .....**72.95**

### Off Trail 2 (LOOT2B)

A versatile beltpack for a pro SLR, with inner and outer mesh pockets and a DryFlo mesh lumbar pad. Use one or both detachable lens cases, or substitute your favorite SlipLock add-ons. It accepts a pro SLR (including a Nikon F5) with an 80–200mm f/2.8 lens attached (most makes), 2–3 more lenses and accessories. It's main compartment interior is 7.25 x 6 x 11.25" (WDH); the lens case interior is 3.5D x 8.5" (DH) .....**60.95**

**Off Trail 1:** Similar to the Off Trail 2, but a bit smaller. It is great for hiking and biking with just the essentials. It holds an SLR with an attached lens, 2 more lenses, film and accessories. The main compartment interior is 6 x 4.5 x 7"; the lens case interior is 3.25 x 5.5". Available in Black (LOOT1B) .....**37.95**



www.bhphotovideo.com

# LOWEPRO

## ADVENTURER SERIES BELTPACKS



### Sideline Shooter

A slim-profile, high-performance belt pack that lets you grab film and equipment in seconds, through a quick-access top zip — without opening the main zipper. Ideal for photojournalists, sports shooters and nature photographers, this pro-quality belt pack stows cameras, video gear or film. Adjustable padded dividers keep film and equipment organized; the padded mesh backpad and BatWing compression straps keep everything snug. It holds an SLR camera body with 2–3 lenses, flash and accessories; or up to 50 rolls of film. Interior dimensions are 12 x 5 x 6" (WDH). Available in Black (LOSLSB) .....51.95

### Photo Runner

This compact, convertible shoulder bag/belt pack provides freedom of movement for runners, hikers and cyclists. Carry it with the hide-away waistbelt and removable contoured shoulder strap. BatWing compression straps stabilize your load and vertical compression straps hold a jacket or small tripod. There's a front zip pocket and, for fast access, a DualZip Top handle. It holds an SLR with 2 compact zoom lenses or a small medium format rangefinder system. Interior dimensions are 11 x 4.5 x 7" (WDH). Available in Black (LOPRB) and Royal Blue (LOPRRB) colors .....43.95



BAGS

565

## ADVENTURER SERIES TOPLOADING BAGS



### Toploader 75 AW (LOTL75AW)

A pro-quality holster bag that's a shoulder bag, chest pack or — with an optional S&F Deluxe Waistbelt — a belt pack. Great for sports and nature photography with hands-free movement and instant access to gear through the reverse-open lid. The water-resistant Toploader 75 AW includes a DryFlo mesh-covered backpad, All Weather Cover, Chest Harness, and attachment loops for SlipLock Pouches, Lens Cases and other SlipLock add-ons. It accepts a large pro SLR (including Nikon F5) with an attached 80–200mm f/2.8 lens (most makes) and hood (reversed). Interior dimensions are 7 x 6 x 12.5" (WDH) .....78.95

### Toploader 70 AW (LOTL70AW)

A slightly smaller holster bag made for travel and active sports, with an All Weather Cover to see you through the toughest conditions. Carry it on the Chest Harness (included), on the shoulder strap — or add an optional S&F Deluxe Waistbelt and use it as a belt pack. Includes a reverse-open lid and attachment loops for optional SlipLock add-ons and Cinch Straps. Capacity: SLR with attached 80–200mm f/2.8 lens (most makes) and lens hood (reversed). It's interior dimensions are 6.5 x 6 x 10" (WDH) .....69.95

### Toploader 65 AW (LOTL65AW)

This compact Toploader has closed-cell foam protection, plus an All Weather Cover. A generous front pocket simplifies film and filter changes. A belt slot lets you slide the bag onto your belt. Optional Chest Harness and Cinch Straps are available. It can hold an SLR with an attached small-to-medium zoom lens and accessories. Interior dimensions are 6.5 x 6 x 8" (WDH) .....51.95



### HIGHLIGHTS OF THE TOPLOADER AW SERIES



Use a Toploader on its shoulder strap or the S&F Waistbelt, Chest Harness; or combine it with other SlipLock gear.



Toploader attachment loops take optional SlipLock add-ons for extra gear.



Extreme weather calls for the serious protection of the patented All Weather Cover.



When you're traveling light, simply slide an S&F Deluxe Waistbelt or your own belt through the Toploader's back belt slot.

ORDER & INFO. (212) 502-6340 • FAX: (212) 239-7770 (800) 947-7008  
1-800-290-6750 • www.bhphotovideo.com



# LOWEPRO

## PHOTOJOURNALIST SERIES

BAGS

566

### Putting Your Street and Field System Together

LowePro's original and most comprehensive modular carrying system makes all kinds of sense. You choose the system you need — and change it as often as you want. Whether you're an outdoor photographer, a wedding photographer or a photojournalist, you can build a personal system to fit your needs.



#### The SlipLock System

Many different bags and packs are compatible with SlipLock add-ons (a wide variety of pouches). A reinforced attachment tab slides into any SlipLock loop and fastens securely. Attach SlipLock add-ons to your own belt or other SlipLock base products.



#### The Tri-Glide Attachment:

This heavy-duty webbing system connects an S&F Shoulder Harness or Vest Harness to a Deluxe Waistbelt and larger bags and packs.

**Cinch Straps:** Used to keep S&F components close to body for stability and freedom of movement.

**Waistbelt Slot:** To use with a Deluxe Waistbelt on some of the larger bags.



#### S&F Shoulder Harness

Use with the S&F Deluxe Waistbelt to carry SlipLock components and support larger cases. With shock absorbing DryFlo mesh-covered padding, CollarCut shoulder straps and adjustable sternum strap for extra heavy load support. Capacity: up to 4 SlipLock add-ons, depending on size.

|   |  |   |
|---|--|---|
| <b>Small/Medium</b><br>LOSHSSF ..... <b>32.95</b> | <b>Large</b><br>LOSHLSF ..... <b>34.95</b> | <b>Extra Large</b><br>LOSHXLSF ..... <b>34.95</b> |
|---|--|---|

*S&F Shoulder Harness and S&F Vest harness must be used with the S&F Deluxe Waistbelt, sold separately.*



#### S&F Vest Harness (LOVHSF)

Add the Vest Harness to the S&F Deluxe Waistbelt to provide maximum carrying capacity for SlipLock add-ons and support for larger equipment cases. Made with extra wide padded shoulders and breathable mesh for comfort, the S&F Vest Harness has ten attachment loops plus inner mesh pockets. One size fits most .....**48.95**

#### S&F Deluxe Waistbelt



*Waistbelt shown with optional SlipLock add-ons*

The S&F Deluxe Waistbelt carries SlipLock components and fits the slot on many large bags and packs. Lets you carry a substantial weight comfortably.

|  |   |
|--|---|
| <b>Extra Small (LOWB9SF)</b><br>For 24-28" waist..... <b>26.95</b>   | <b>Large (LOWB13SF)</b><br>For 34-42" waist..... <b>34.95</b>       |
| <b>Small/Medium (LOWB11SF)</b><br>For 28-34" waist..... <b>29.95</b> | <b>Extra Large (LOWB15SF)</b><br>For 42-48" waist..... <b>37.95</b> |

#### S&F Light Belt



*Light Belt shown with optional SlipLock add-ons*

The Light Belt has attachment loops to hold SlipLock add-ons. Made for light to moderate loads, the S&F Light Belt has a DryFlo padded lining and an adjustable quick-release buckle. (The Light Belt is not compatible with products that use the S&F Shoulder Harness or Vest Harness.)

|  |  |
|--|--|
| <b>Small/Medium (LOB9SF)</b><br>For 28-40" waist..... <b>18.95</b> | <b>Large/Extra Large (LOB11SF)</b><br>For 32-46" waist..... <b>18.95</b> |
|--|--|





# LOWEPRO

## PHOTOJOURNALIST SERIES

### NOTEBOOK & CAMERA COMBOS



Stealth AW II

Stealth Reporter 650 AW

CompuTrekker Plus AW

CompuTrekker AW

Rolling CompuTrekker Plus AW

**Stealth AW II (LOS AW2B):** A premium backpack for on-the-go photojournalists and sports photographers, with room for a notebook, camera system, overnight essentials and a small virtual office. It has an adjustable backpack harness; sternum strap and back pad with DryFlo mesh; and an All Weather Cover. An included Cell Phone Pouch can be detached and fastened to a belt. It accepts 1–2 pro SLRs, 3–4 lenses, notebook (up to 16", most makes), cell phone, file folders, and accessories. Backpack interior: 15 x 3.5 x 20" (WDH); Notebook case interior: 11 x 2 x 14" (WDH) .....**193.95**

**Stealth Reporter 650 AW (LOS R650 AWB):** Designed for news photographers and photojournalists, with instant access to gear through the top zip. An All Weather Hood, All Weather Cover and adjustable, padded notebook compartment, adjustable dividers and padded lens cups protect your equipment. Carry the bag on the padded, shoulder strap or add an optional Street and Field Deluxe Waistbelt to take the weight off your shoulders. Takes optional SlipLock add-ons. It carries a large pro SLR with 80–200mm f/2.8 lens attached; additional body; 2 short lenses; large notebook; memory cards, flash, charger and small tripod. Interior size is 14.5 x 8.5 x 11" (WDH) .....**135.95**

**CompuTrekker Plus AW (LOCT PAWB):** Designed for photographers on the go, the CompuTrekker Plus AW is the perfect solution for those who are looking for a lightweight backpack to store and transport camera equipment, accessories and up to a 17" notebook computer. Rugged construction protects contents from moisture and sudden impacts while providing a comfortable carrying solution. It holds a pro SLR with up to 400mm f/2.8 lens attached as well as an additional body, four or five more lenses, plus a laptop, with accessories. The interior is fully customizable and includes removable padded dividers, removable accessory pouches and see-through laminated mesh pockets. The CompuTrekker Plus AW features an adjustable backpack harness with padded contoured shoulder straps, attachment loops on the sides that accept Street & Field or SlipLock system accessories, a fold-out vertical tripod mount with bungee straps that keeps your tripod in place, a built-in All Weather cover, and Dry-Flo mesh-covered back pads. Main Compartment: 13 x 5.3 x 18.9"; Laptop compartment: 11.6 x 1.9 x 18.7" (WDH).....**169.95**

**CompuTrekker AW (LOCT AWB):** The CompuTrekker AW is for photojournalist and location photographers who want to take a camera system with a laptop on a day trip, or who need a safe and compact way to safely store and transport their system. It holds an SLR with an 80-200 f/2.8 lens attached as well as an additional body and four or five more lenses, plus a laptop up to 15" long. Attachment loops expand your carrying capability with optional SlipLock accessories. Flexible interior dividers can be easily arranged to fit medium format or video equipment. The CompuTrekker AW offers reinforced construction, shock-absorbing closed-cell foam padding, tough water-resistant outer fabric, a built-in All Weather Cover, and a quick-access hide-away Tripod Mount. Main compartment: 11 x 5 x 15"; Laptop compartment: 12 x 1.5 x 15" (WDH).....**129.95**

**Rolling CompuTrekker Plus AW (LOCR PAWB)**  
Designed for photographers who need a versatile solution, the Rolling CompuTrekker Plus AW is a rolling bag that can also be worn as a backpack. It holds a pro SLR with up to 400mm f/2.8 lens attached as well as an additional body, four or five more lenses, and a laptop up to 15.4" long, with accessories. Rugged construction protects its contents while providing photographers with a comfortable backpack and a nimble rolling bag. The interior is fully customizable and includes removable padded dividers, removable accessory pouches and see-through laminated mesh pockets so you can quickly see what's stored inside. The main compartment is 13 x 5.5 x 16.3", the removable laptop pocket is 11 x 1.6 x 13.6" .....**259.95**

**BAGS**

**567**

# LOWEPRO

## PHOTOJOURNALIST SERIES

### Stealth Reporter AW Bags

Originally made for photojournalists, Stealth Reporter AW bags have features every photographer will love: quick access through a unique top zipper, removable padded inserts, an All Weather Cover for total protection from the elements, and an All Weather Hood for weather protection and fast gear access.

You can customize the interior to suit your system, and there are lots of pockets for small accessories.

The Stealth Reporters 500 and 400 AW also include moveable, foam-padded lens cups. Attachment loops take optional SlipLock add-ons, (includes two cinch straps to secure), and there's a Waistbelt slot on every model (except the Stealth Reporter AW 100) for a S&F Deluxe Waistbelt to help take weight off your shoulders.



Stealth Reporter 500 AW

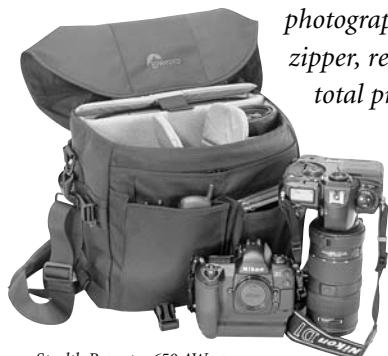

Stealth Reporter 650 AW open

#### Stealth Reporter 500 AW (LOSR500AWB)

Holds two pro SLR cameras, 5-6 lenses (up to 80-200mm f/2.8), a pro flash, PDA, a cell phone, film and accessories. It's interior size is 14 1/4 x 6 1/4 x 9 1/2"; the exterior size is 16 x 9 x 11", and it weighs 4.5 lbs .....**129.95**

#### Stealth Reporter 400 AW (LOSR400AWB)

Holds two 35mm SLRs, 4-5 lenses, a pro flash, film, accessories, PDA, a cell phone and accessories. It's interior size is 12 1/2 x 6 1/4 x 9 1/2"; the exterior size is 14 x 9.5 x 11", and it weighs 3 lbs.....**119.95**



Stealth Reporter 100 AW

Stealth Reporter 200 AW

#### Stealth Reporter 300 AW (LOSR300AWB)

Holds a pro SLR, 4-5 lenses, flash, film and accessories. It's interior size is 10.75 x 6.75 x 7.75" (WDH) and it weighs 3 lbs .....**103.95**

#### Stealth Reporter 200 AW (LOSR200AWB)

Holds a pro SLR, 3-4 lenses, flash, film and accessories. It's interior size is 9.25 x 6.7 x 7.75" (WDH) and it weighs 2.8 lbs .....**89.95**

#### Stealth Reporter 100 AW (LOSR100AWB)

Holds a pro 35mm SLR, 2-3 lenses, film and accessories. It's interior size is 9.25 x 6 x 6" (WDH) and it weighs 2.4 lbs .....**74.95**

BAGS

568

## PROFICIONADO SERIES: D-PODS SERIES

Good things definitely come in small packages. Designed specifically for small cameras, these pouches stretch for a snug fit while providing plenty of protection. The sleek design and stretchy, water-resistant material eliminates bulk but still has room for memory cards, batteries or small accessories. They are SlipLock compatible, but also include a removable shoulder strap.

**D-Pods 50 Pouch (LODP50B):** 3.25 x 2 x 5.5" interior .....**18.95**

**D-Pods 40 Pouch (LODP40B):** 3 x 1.5 x 5.5" interior .....**16.95**

**D-Pods 30 Pouch (LODP30B):** 2.75 x 1.5 x 5" interior .....**15.95**

**D-Pods 20 Pouch (LODP20B):** 3 x 1 x 4" interior .....**14.95**

**D-Pods 10 Pouch (LODP10B):** 2.5 x .75 x 3.5" interior .....**12.95**



D-Pods 10

D-Pods 30

D-Pods 20

D-Pods 40

D-Pods 50



**ONE HOUR FREE PARKING**  
AT 349 W. 34th STREET (with purchase of \$100 or more)

# LOWEPRO

## PORTABLE STUDIO SERIES

### Shoulder Bags

The Portable Studio Series shoulder bag collection features pro-quality shoulder bags that are created from water-resistant 1200D ballistic TXP and 2000D ballistic nylon fabric. They all have an OverLap Zipper; an All Weather Cover for rough weather and dust; a removable FilmPack; extensive pockets; a thickly padded shoulder strap and padded leather handle, and attachment loops for optional SlipLock accessories.

#### Commercial AW (LOCAWB)

A large, pro-quality shoulder bag with two detachable Pro AW Side Pockets, a thickly padded shoulder strap, padded leather handle and Belt & Buckle. The totally flexible, modular interior lets you stow bodies and most-used lens horizontally or vertically — or flip the divider for a different layout. It accepts 2 pro SLRs, 6–8 lenses and accessories. Interior size is 17 x 9 x 9"; exterior size is 19 x 12.5 x 11" (WDH).....**191.95**

#### Commercial AW MF (LOCAWMFB)

A Commercial AW bag with roomier interior compartments for larger medium format systems. It holds a 6 x 7 SLR (including larger medium format cameras), prism finder, 3–4 lenses, 2–3 roll film backs, large pro flash and accessories .....**215.95**

#### Magnum AW (LOMAWB)

This pro bag features a customizable interior; lots of inner and outer pockets (including a NoDrop Pocket for film and filter changes); two detachable Pro AW Side Pockets while the belt loops take an optional Belt & Buckle for carrying comfort and stability. It holds 2 pro SLRs with attached lenses, 4–5 additional lenses, a pro flash and accessories. Interior size is 15.5 x 8 x 8.5" (WDH); exterior size is 17 x 12.5 x 10" .....**161.95**

#### Magnum AW MF (LOMAWMFB)

The same exterior as the popular Magnum AW, with larger modular interior compartments for larger medium format systems. It accepts a 6 x 6 or 645 medium format SLR with prism finder, 4 lenses, 3-roll film backs, flash and accessories).....**163.95**



#### Compact AW (LOCAWBQ)

A hardworking shoulder bag that includes lots of inner and outer pockets and two removable Pro AW Side Pockets. It can hold 2 pro SLRs, 3–5 lenses, flash and accessories; or a 645 medium format camera, 4 lenses and accessories. Interior size is 13 x 7.75 x 8" (WDH) .....**126.95**

#### Pro Mag 2 AW (LOPM2AWB)

A slim-profile bag for special assignments. The high-density, closed-cell foam provides serious protection. A divider system, many pockets and straps for a light tripod keep you organized. The award-winning Pro Mag 2 includes a Belt & Buckle, and accepts 1–2 large pro SLRs (including Nikon F5), 4–5 lenses (up to 80–200mm f/2.8 with reversed hood), flash and accessories. Its interior size is 11 x 6.5 x 10" (WDH) .....**119.95**

#### Elite AW (LOEAWB)

A compact pro shoulder bag for a smaller system. The adjustable divider system lifts out for easy access to bottom compartments. It can hold either a pro SLR, 3–4 lenses, flash, film and accessories; or a compact medium format system. Its interior size is 11 x 7 x 8" (WDH) .....**106.95**

#### Mini Mag AW (LOMMAWB)

A compact professional bag for your most basic system. Closed-cell foam provides serious protection. It includes a flexible interior; NoDrop Pocket and a laminated mesh pocket. It accepts a pro SLR with attached lens, 2–3 more lenses, film and accessories. Interior size: 9.5 x 6 x 7.5" (WDH) .....**85.95**

BAGS

569

# LOWEPRO

## PORTABLE STUDIO SERIES

BAGS

570

### HARD & SOFT SHELL COMBOS



#### **Omni Trekker & Trekker Extreme** (LOOTEBQ)

The convertible Omni Trekker backpack/shoulder bag fits into the waterproof Trekker Extreme hard case (or Pelican 1550). The Omni Trekker has a unique removable/hide-away backpack harness; rugged metal hardware; a reverse-open lid; front and top zipper access (so you can grab gear even when the Omni Trekker bag is in the Trekker Extreme case); removable tripod straps; laminated mesh pockets; a padded, contoured shoulder strap; and fully customizable interior. It can hold 1–2 SLRs, 6–8 lenses and accessories; or a medium or large format system. The bag interior is 17.5 x 5.25 x 13" (WHD); its exterior is 18 x 6.5 x 13.5" (WHD). The case exterior is 20.5 x 8.5 x 16.75" (WHD).....**292.95**

#### **Omni Pro & Pro Extreme** (LOOPEB)

The Omni Pro, a slim, attaché-style bag is sized to fit a waterproof Pro Extreme hard case (or a Pelican 1520). The Omni Pro features removable tripod straps; metal hardware; a padded, contoured shoulder strap; and a fully customizable interior that equips the Omni Pro for professional shoots. It carries 1–2 SLRs, 5–7 lenses, film and accessories; or a compact medium format system. The Omni Pro interior is 16 x 5.5 x 11.5" (WHD); its exterior is 17.5 x 6.25 x 12.25" (WHD). The Pro Extreme case is 19.25 x 7.5 x 15.5" (WHD).....**227.95**

#### **Omni Traveler & Traveler Extreme** (LOOTEB)

An attaché-style case (the Omni Traveler) teams up with the waterproof Traveler Extreme hard case (or a Pelican 1450). Omni Traveler has a customizable interior with mesh pockets; heavy-duty metal hardware; padded, contoured shoulder strap; plus top and front zipper access. Capacity: SLR, 4–6 lenses, film and accessories; a or compact medium format system. The Omni Traveler interior is 13.5 x 4.5 x 9" (WHD); its exterior is 14.5 x 5.25 x 10" (WHD). The Traveler Extreme hard case is 16W x 7 x 13" (WHD) .....**154.95**

#### **Omni Sport and Sport Extreme** (LOOSEB)

The Omni Sport convertible backpack/shoulder bag slides into a waterproof Sport Extreme hard case (or a Pelican 1400). The Omni Sport works as a shoulder bag on the removable, padded, contoured shoulder strap or a backpack on its hide-away waistbelt. Gear is easily accessible, even in the Sport Extreme case. The customizable interior has handy laminated mesh pockets for film and accessories. Capacity: SLR, 2–3 lenses, film and accessories. The Omni Sport interior is 9.75 x 8" (WHD); its exterior is 11.5 x 5 x 7.5" (WHD). The Sport Extreme is 13 x 6 x 12" (WHD) .....**111.95**



| Capabilities              | Large Format | Medium Format | Medium Format Rangefinder | Pro 35mm SLR Camera | 35mm SLR Camera | Digital Still Camera | Airline carry-on |
|---------------------------|--------------|---------------|---------------------------|---------------------|-----------------|----------------------|------------------|
| Omni Trekker and Extreme  | •            | •             | •                         | •                   |                 | •                    |                  |
| Omni Pro and Extreme      |              | •             | •                         |                     | •               | •                    | •                |
| Omni Traveler and Extreme |              | •             | •                         |                     | •               | •                    | •                |
| Omni Sport and Extreme    |              |               |                           |                     | •               | •                    | •                |



For Any Inquiries Regarding Your Order, Call Our Customer Service:  
 (800) 221-5743 • (212) 239-7765 • FAX: (800) 947-2215 • (212) 239-7549

# LOWEPRO

## PORTABLE STUDIO SERIES

### PRO ROLLERS

#### **Pro Roller 3** (LOPR3B)

Designed as a workhorse, the Pro Roller 3 has an ultra strong resilient ABS plastic inner casing, a heavy-duty wheel-and-handle system with oversize molded plastic bumpers and a rigid plastic divider system covered with extra foam padding and soft tricot lining to keep equipment snug and safe. Two removable tripod/light stand holders carry essential hardware, while a bungee cord system lets you add an additional large camera bags or a briefcase. It includes lockable zipper tabs, a removable padded handle, SlipLock attachment loops and a prop-up stand. It holds 2 large flash heads, power pack, umbrellas, tripods and/or light stands, gels and gel holders; plus 6 x 7 SLR (including a larger medium format camera), prism finder, 3-4 lenses, 2-3 film backs, a large pro flash and accessories; or 35mm or digital pro SLR system. Interior size: 17 x 9 x 22" (WDH); exterior size with tripod holders attached: 24.5 x 14 x 25" (WDH)....**339.95**

#### **Pro Roller 2** (LOPR2B)

An essential rolling case for professional assignments, the Pro Roller 2 has a super-tough wheel-and-handle system, plus two tripod/light stand holders and an exterior bungee web. It includes ample inner and outer pockets, top and front attachment systems for extra cases, a prop-up stand and leather-wrapped, padded handles. It accepts a pro SLR system; or 6 x 7 SLR, 3-4 lenses, film backs, handle-mount flash and accessories; or SLR plus medium format equipment. Interior size is 14 x 7 x 21.5" (WDH); exterior size with tripod holder is 16.5 x 11 x 25.25" (WDH) .....**279.95**

#### **Pro Roller 1** (LOPR1B)

A tough professional rolling case with all the features of the Pro Roller 2, but a bit smaller. Interior size is 12 x 5.5 x 17.5" (WDH).....**239.95**

#### **Pro Roller Mini** (LOPRM)

An ultra-compact professional rolling case, the Pro Roller Mini has a fully customizable interior removable insert for easy format changes and leather-wrapped padded top handle. It holds a pro SLR with an attached 80-200mm f/2.8 lens, an extra body, 4 more lenses and accessories. Interior size is 11 x 4.25 x 15.5" (WDH).....**169.95**



Attached bags shown on Pro Roller 3 and 2, and all tripods shown with any Pro Roller are optional, and are not included.

BAGS

571

### HIGHLIGHTS OF THE PRO ROLLERS

#### **PRO ROLLER 3 HIGHLIGHTS**



A flip-up stand makes it easy to see and grab equipment.

Dividers are rigid plastic covered with two layers of foam for maximum protection from impact. The Pro Roller 3's structural casing is the same tough plastic as crash helmets.



#### **PRO ROLLER 2, 1 & MINI HIGHLIGHTS**

Exterior bungee cords hold a reflector or other oversize gear.



Change formats without changing bags – just get an extra Multi-Format or Medium Format Pro Roller Insert for your other system. Or remove the insert and use the Pro Roller as luggage.



ORDER & INFO. (212) 502-6340 • FAX: (212) 239-7770 (800) 947-7008  
**1-800-290-6750 • www.bhphotovideo.com**



# LOWEPRO

## PROFICIONADO: NOVA SHOULDER BAGS

BAGS

572

**Nova 1 AW:** A very compact bag for those who like a smaller system and a lighter weight. Features include an OverLap Zipper for 360° protection, No Drop Pocket for fearless film and filter changes, interior and exterior pockets, a padded, contoured shoulder strap, padded handle and belt loops. Holds 1 SLR with attached mid-range zoom, 1-2 extra lenses and accessories. It is 7.75 x 4 x 6.5" (WxDxH), and is available in Black (LON1AWB), Navy Blue (LON1AWN), Forest Green (LON1AWGR), Grey (LON1AWG) and Red (LON1AWR). Water-resistant 600D TXP and 600D TXP ripstop outer fabric .....**32.95**



**Nova Mini AW:** Everything you need for a digital or compact SLR system. Accessory pockets stow the extras, while the OverLap Zipper offers extra protection. Carrying options include a non-slip shoulder strap, a padded handle and belt loops for your belt or an optional Belt & Buckle. Holds 1 SLR with 1-2 lenses or a flash plus an extra lens or a digital camera or a compact camcorder. It's dimensions are 6.5 x 3.5 x 6.5" (WxDxH), it is available in Black (LONMAWB), Navy Blue (LONMAWN), Forest Green (LONMAWGR), Grey (LONMAWG) and Red (LONMAWR). Water-resistant 600D TXP and 600D TXP ripstop outer fabric...**27.95**



**Nova Micro AW:** The smallest Nova, this versatile bag takes a variety of cameras. Carry it on the non-slip shoulder strap, by the padded handle or add the optional Belt & Buckle and use it as a belt pack. An OverLap Zipper gives your gear extra protection and there is an outer accessory pocket and belt loops. Holds 1 SLR with built-in zoom and flash, or 1 SLR with short zoom, or a digital still camera. 5 x 3.5 x 6" (WDH). Available in Black (LONMAWBQ), Navy (LONMAWNQ), Forest Green (LONMAWGRQ), Grey (LONMAWGRQ), or Red (LONMAWRQ). Outer fabric: Water-resistant 600D TXP and 600D TXP ripstop .....**24.95**

**Nova 2 AW:** This small, redesigned light bag loves to travel. The Nova 2 AW has hi-tech materials; and an all-weather cover to protect gear from the elements, dust and torrential rain. It has a customizable interior; OverLap Zipper; NoDrop Pocket for film and filter changes; many inner and outer pockets; a curved, pressed-foam shoulder strap; belt loops; and padded handle. Holds an SLR with attached an lens, 2-3 more lenses and accessories. Size: 8.5 x 4.25 x 7.75" (WxDxH). Available in Black (LON2AWB), Navy (LON2AWN), Forest Green (LON2AWGR), Grey (LON2AWG), or Red (LON2AWR).....**38.95**



**Nova 4 AW:** The perfect travel bag with adjustable dividers that customize the interior for your system. An invaluable all weather cover guards your gear from rain, snow, dust and sand, while a curved, pressed-foam shoulder strap offers carrying comfort. It features an OverLap Zipper; a NoDrop Pocket; padded handle; belt loops; tough metal hardware; inner and outer mesh pockets; and back security pocket. Holds 1-2 SLRs, 3-5 lenses, flash and accessories. Size: 11.5 x 6 x 7.75" (WxDxH). Available in Black (LON4AWB), Navy (LON4AWN), Forest Green (LON4AWGR), and Grey (LON4AWG) .....**52.95**



**Nova 3 AW:** The Nova 3 AW has a sleek new look and an All Weather Cover to help guard your gear. Movable dividers adjust the interior for your equipment. Film and accessories go in the inner and outer mesh pockets, security pocket and front NoDrop

Pocket. Includes an OverLap Zipper; rugged metal hardware; a curved, pressed-foam shoulder strap; and padded handle. It holds a SLR, 3-4 lenses, flash, compact camcorder and accessories. Size : 9 x 6 x 7.5" (WxDxH). Available in Black (LON3AWB), Navy (LON3AWN), Forest Green (LON3AWGR), and Grey (LON3AWG) .....**43.95**



**Nova 5 AW:** This lightweight shoulder bag features an All Weather Cover for really bad weather and dust, a sleek exterior and a curved, pressed-foam shoulder strap. It holds most SLR systems with space for accessories in the mesh side pockets, inner mesh pocket, back security pocket and organizer pockets. An OverLap Zipper offers extra protection; a NoDrop Pocket delivers safer film and filter changes. Holds 2 SLRs with attached lenses, 4-5 more lenses and accessories. Size: 14 x 6 x 8.5" (WxDxH). Available in Black (LON5AWB), Navy (LON5AWN), Forest Green (LON5AWGR), and Grey (LON5AWG).....**64.95**



EQUIPMENT LEASING AVAILABLE

# LOWEPRO

## PROFICIONADO SERIES

### TOPLOADING BAGS

#### Topload Zoom Mini

Lowepro's smallest holster-style shoulder bag. Made from water-resistant 600D TXP and 600D TXP ripstop, the Topload Zoom Mini features a zippered front pocket and an interior laminated mesh pocket to keep filters and small accessories organized. A reverse-open lid provides quick access. Carry the Topload Zoom Mini on its non-slip shoulder strap or on your belt. It can hold a small SLR with short lens attached or APS, film and accessories. It is 6 x 4 x 6.5" (WxDxH). The Topload Zoom Mini is available in Black (LOTLMZB), Navy Blue (LOTLMZN), Forest Green (LOTLMZFG) and Red (LOTLMZR) colors .....19.95



**Topload Zoom 1:** Accepts a compact SLR with wide-angle or compact zoom and accessories. 6.5 x 4.5 x 7.75" (WxDxH). Available in Black (LOTLZ1B), Navy Blue (LOTLZ1N), and Forest Green (LOTLZ1GR) colors .....22.95

**Topload Zoom 2:** Accepts an SLR with attached lens, an additional mid-sized zoom lens and accessories. 7 x 5 x 9.75" (WxDxH). Available in Black (LOTLZ2B), Navy Blue (LOTLZ2N), and Forest Green (LOTLZ2GR) colors .....27.95

**Topload Zoom AW:** Accepts a pro SLR with 80-200mm f/2.8 lens attached. 7 x 5 x 11.75" (WxDxH). Available in Black color (LOTLZAWB) .....49.95

### Z-SERIES POINT & SHOOT BAGS

*These practical, versatile, padded zip pouches feature water-resistant non-abrasive outer fabric and shock-absorbing closed-cell foam padding. Each has a large expandable front pocket, belt loop and quick-release strap. They all hold a small auto-focus or APS or digital camera; compact binoculars; or accessories. These pouches are available in Black, Forest Green, Navy Blue, Red, and Royal Blue.*



**Z20 Pouch:**  
A compact zippered pouch for a small point-and-shoot camera or personal essentials. Includes a large, expandable front pocket, belt loop, and a quick-release shoulder strap. 3 x 1.75 x 5.5". It is available in Black (LOZ20B), Royal Blue/Black (LOZ20RB), Forest Green/Black (LOZ20GR), Red/Black (LOZ20R), and Navy/Black (LOZ20N) .....12.95



**Z10 Pouch:**  
This small zipper pouch is perfect for carrying a small camera or cell phone. The Z10 includes an expandable front pocket, a belt loop, and a quick-release shoulder strap. 2.75 x 1.75 x 4.75". It is available in Black (LOZ10B), Royal Blue/Black (LOZ10RB), Forest Green/Black (LOZ10GR), Red/Black (LOZ10R), and Navy/Black (LOZ10N) .....10.95



**Z5 Pouch:**  
The smallest Z-Series pouch will hold an auto-focus or APS camera, digital camera, cell phone or mini tape recorder. It includes a large, expandable front pocket, belt loop, and a quick-release shoulder strap. It is available in Black (LOZ5B), Royal Blue/Black (LOZ5RB), Forest Green/Black (LOZ5GR), Red/Black (LOZ5R), and Navy/Black (LOZ5N) .....8.95

BAGS

573



# LOWEPRO

## PROFICIONADO SERIES

BAGS

574

### REZO SHOULDER POUCHES

Designed to withstand the elements of a grueling trek, yet stylish enough to use around town, the Rezo AW series will satisfy even the most discerning photographers. Lightweight and feature packed, these shoulder bags provide SLR users with everything they need to work quickly and easily. They feature a reverse open lid, a front accessory pocket and attachment loops that accept SlipLock compatible products.

- Rezo 170 AW (LOR170B):** Inner dimensions are 8.75 x 4.5 x 7.9" (WDH) .....**44.95**
- Rezo 160 AW (LOR160B):** Inner dimensions are 8.5 x 4.1 x 7" (WDH) .....**39.95**
- Rezo 140 AW (LOR140B):** Inner dimensions are 7.1 x 4.1 x 6.7" (WDH) .....**34.95**
- Rezo 120 AW (LOR120B):** Inner dimensions are 6 x 4.1 x 6.5" (WDH) .....**29.95**
- Rezo 110 AW (LOR110B):** Inner dimensions are 6 x 3.9 x 5.1" (WDH).....**CALL**



### REZO TOP LOAD ZOOM BAGS

**Rezo TLZ 20 Camera Holster Bag (LORTLZ20B)**  
This holster-style bag with a stretch-to-fit lid and quick-release buckle was designed to fit the new generation of compact digital SLR cameras and accessories. It features a water-resistant outer fabric, a padded handle, a SlipLock attachment tab, and a removable adjustable shoulder strap. 5.25 x 4 x 7" interior.....**29.95**

**Rezo TLZ 10 Camera Holster Bag (LORTLZ10B)**  
Same as the above, but slightly smaller. It's interior dimensions are 5.25 x 3.75 x 5.5" .....**27.50**

### REZO CAMERA POUCHES

Rezo camera pouches offer a stylish custom fit for both point & shoot and digital cameras by combining a special stretch fabric designed to hug the camera and provide greater safety and protection for transporting. They have an exceptional design as well as a unique, slim fit that conforms to a variety of camera shapes without the bulk. These pouches offer a front accessory pocket for easy access to accessories, a front flap with a Velcro tab for extra security, an adjustable, removable shoulder strap for carrying comfort, full-rotation metal clips that allow a wide range of motion and a SlipLock attachment tab that permits you to attach your bag to a belt, purse, briefcase, or any SlipLock compatible product.



**Rezo 60 (LOR60B):** Inner Dimensions:  
2.95 x 2.76 x 5.51" (WDH) .....**23.95**

**Rezo 40 (LOR40B):** Inner Dimensions:  
2.28 x 1.57 x 5.31" (WDH) .....**18.95**

**Rezo 20 (LOR20B):** Inner Dimensions:  
2.95 x 1.18 x 4.13" (WDH) .....**17.95**

**Rezo 50 (LOR50B):** Inner Dimensions:  
2.95 x 1.46 x 5.12" (WDH) .....**19.95**

**Rezo 30 (LOR30B):** Inner Dimensions:  
2.76 x 1.38 x 4.80" (WDH) .....**18.95**

**Rezo 10 (LOR10B):** Inner Dimensions:  
2.76 x .59 x 3.74" (WDH) .....**14.95**



[www.bhphotovideo.com](http://www.bhphotovideo.com)

# LOWEPRO

## LENS CASES

### Phone Pouches

Three go-everywhere phone pouches, designed for today's smaller cell phones. And with three ways to attach them, you can carry them your way: a snaphook clips to a belt loop or D-ring; an attachment tab fastens to your belt or a SlipLock base product; and a vertical hook-and-loop attachment wraps around shoulder straps or shoulder harness. The top flap (with antenna cut-out) has a hook-and-loop closure.



- Phone Pouch 30** (LOCPPSF30)  
Size (Interior):  
2.5W x 1.25D x 5H" .....**12.95**
- Phone Pouch 20** (LOCPPSF20)  
Size (Interior):  
2W x 1D x 4.5H" .....**10.95**
- Phone Pouch 10** (LOCPPSF10)  
Size (Interior):  
2.25W x 1D x 4H" .....**9.95**

### Lens Case 5 (LOLC5SF)

Special protection for a longer lens, with extra padding, an extra-rigid base and compression straps. The belt slot takes an optional S&F Deluxe Waistbelt — or you can carry it on the shoulder strap. It holds a 300mm f/2.8 or 400mm f/3.5 lens with hood reversed. Interior: 6 x 11.75" (DH) .....**39.95**

### Lens Case 5s (LOLC5SSF)

Made with a rigid base and extra padding for shorter, wider zoom lenses with image stabilizers. Slide a Deluxe Waistbelt or your own belt through the DryFlo mesh-padded waistbelt and carry it in the small of your back for optimum balance. Includes a shoulder strap and compression straps to fasten to Trekker AW packs. Capacity: an 80–200mm f/2.8 or 100–400mm with their hood reversed. Interior size: 6 x 9" (DH) .....**39.95**

### Lens Case 4 (LOLC4SF)

Features a rigid base, shoulder strap and compression straps for attaching to other Lowepro packs and bags. Capacity: an 80–200mm f/2.8 with its hood reversed; or a 300mm f/4 or 35–350mm plus hood. Interior size: 4.5 x 10" (DH) .....**32.95**

### Lens Case 4s (LOLC4SSF)

With a rigid base and additional padding for shorter, wider zoom lenses. Includes shoulder strap and compression straps to fasten to Lowepro packs. Capacity: shorter, wider zooms such as 28–200mm f/3.5 with hood reversed; a 28–70mm f/2.8, 75–300mm f/4.0, or 35–350mm with their hood reversed; or a 17–35mm with hood. Interior size: 4.25 x 6" (DH) .....**32.95**



Lens Case 5

Lens Case 5s

Lens Case 4s

Lens Case 3

Lens Case 1W

### Lens Case 3 (LOLC3SF)

Made with a rigid base to support larger lenses. Capacity: an 80–200mm f/2.8 or 35–350mm with their hood reversed; or a 70–300mm plus hood. Interior size: 4.5 x 8" (DH) .....**26.95**

### Lens Case 2 (LOLC2SF)

It accepts a compact telephoto, wide-angle, small zoom lens, or water bottle. Interior size: 3.5 x 8.25" (DH) .....**19.95**

### Lens Case 1N (LOLC1NSF)

Includes a stacking divider. Capacity: 2 teleconverters or mid-range, variable aperture zoom or fixed focal length lens. Interior size: 3 x 5" (DH) .....**17.95**

### Lens Case 1W (LOLC1WSF)

With an extra-rigid base to support wider lenses. Capacity: wider lenses such as 20–35mm f/2.8 zoom with hood reversed and other short, large-diameter lens. Interior size: 4D x 5" (DH) .....**19.95**

### Lens Case 1S (LOLC1SSF)

With a rigid base to support short lenses. Capacity: 28–90mm f/4.0 zoom; 60mm f/2.8 micro; and 28mm f/2.8 (all without their hoods) and most 50mm lenses. The interior size is 3 x 3.5" (DH) .....**16.95**

### Lens Case 1 (LOLC1SF)

Capacity: compact normal or side-angle lens or short zoom. 3.25 x 5" (DH) interior .....**17.95**

BAGS

575

# LOWEPRO

## ACCESSORIES

BAGS

576

### Film Drop AW (LOFDAWSF)

A quick-drop film case (with an All Weather Cover) for exposed film. Slip film through the aperture-style lid opening and it's safe. A lockable zip holds up to 20 rolls of 35mm film (without film canisters) or 16 rolls of 120/220 film (out of the box). 3.5 x 5" interior. Essential when seconds and security are at a premium.....**19.95**

### Snap Top AW (LOSTAWSF)

A revolutionary pouch for film or accessories. The patented MagBag spring ring snaps open for instant access and snaps shut just as fast. This unpadded pouch includes an All Weather Cover for protection against extreme elements and dust. Capacity: up to 30 rolls of 35mm film in canisters, or accessories. 6 x 4 x 7" .....**30.95**

### Photo Gloves

Soft, warm gloves made of Lycra, with DuPont Thermax to wick away moisture, and Control Dots to ensure a firm grip on delicate camera and tripod controls. Ideal for cold weather photography and bicycling.

**Medium Photo Gloves (LOGM).....19.50**

**Large Photo Gloves (LOGL).....19.50**

**Extra Large Photo Gloves (LOGXL) ...19.50**

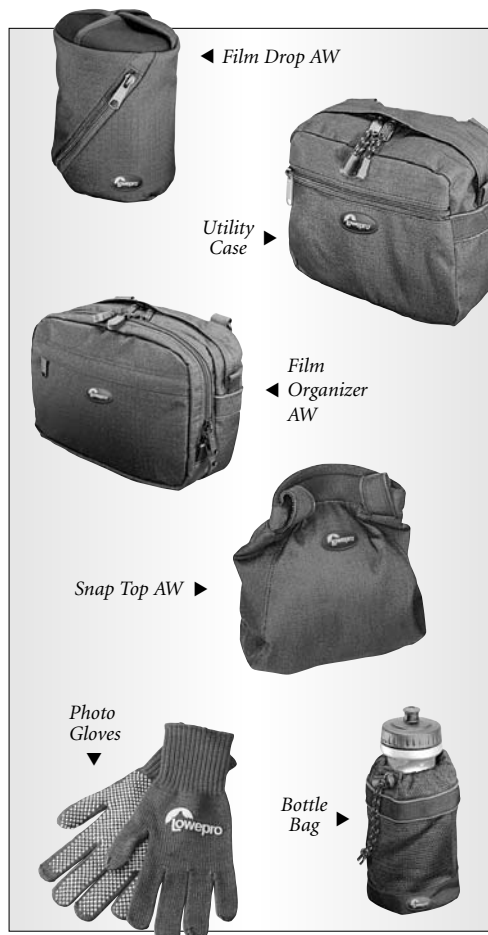

### Utility Case (LOCUSF)

A versatile all-purpose padded pouch with adjustable dividers, laminated mesh pocket and zippered compartments. The front pocket is perfect for the Filter Pouch. The three zip pockets, including a NoDrop pocket, keep everything organized and accessible. The Utility Case holds a point & shoot camera, small lenses, light meter or other accessories. D-rings for use with a shoulder strap. It's interior size is 8 x 2.25 x 6" .....**32.50**

### Film Organizer AW (LOFOAWSF)

The lightweight pouch stores and carries unexposed film, or a combination of exposed and unexposed film (in three separate adjustable compartments). There's an outer zip pocket, shoulder strap and patented All Weather Cover. Capacity: up to 40 rolls of 35mm film (in canisters) or 38 rolls of 120/220 film (out of the box). Size (Interior): 7 x 3.5 x 6" (WDH) .....**24.95**

### Bottle Bag (LOBBSF)

A compact, lightweight mesh bag for a water bottle, film or accessories. Capacity: 32 oz. Nalgene or bicycle bottle. Its interior size is 3.75 x 7" (DH). It can also be used for equipment or accessories. Attachment tabs fasten it to any SlipLock base product or your belt.....**12.50**

## SlipLock Pouches

*SlipLock pouches protect everything from a compact camera or binoculars to a full-sized 35mm SLR body or battery pack. All pouches come with a drawstring hood, shoulder strap and SlipLock attachment tab. Small pouches have a front mesh pocket; Pouch 50 AW and 60 AW have a built-in All Weather Cover for added protection.*



### SlipLock Pouch 60 AW (LOP60AWSF)

Size (Interior): 6.25 x 3 x 7" (WDH) .....**24.95**

### SlipLock Pouch 50 AW (LOP50AWSF)

Size (Interior): 5 x 3.25 x 6" (WDH) .....**18.95**

### SlipLock Pouch 30 (LOP30SF)

Size (Interior): 3.75 x 2.25 x 6" (WDH) ....**15.95**

### SlipLock Pouch 20 (LOP20SF)

Size (Interior): 3.5 x 1.75 x 5.5" (WDH) ...**13.95**

### SlipLock Pouch 10 (LOP10SF)

Size (Interior): 2.75 x 1.75 x 5.5" (WDH)...**12.95**



# LOWEPRO

## ADD-ONS & UPGRADES

### Filter Pocket (LOFPSF)

A convenient, padded pouch designed to fit the front pocket of the Utility Case – and many other Lowepro bags and packs. Vinyl-covered mesh pockets hold the filters; a light background lining makes it easy to find the right one. Capacity: up to 6 filters, maximum 82mm. Interior dimensions are 8.25 x 1 x 4.5" (WDH). Water-resistant 600D TXP ripstop outer fabric .....**13.95**

### Neoprene Camera Strap (LOSCQ)

A high-quality strap with attachments to fit virtually any camera. Soft binding around the edges makes this the most comfortable strap you have ever used. Non-slip dots keep the strap firmly in place for added security. One size fits all .....**16.95**

### Deluxe Shoulder Strap (LOSSDB)

A Lowepro invention, the body contoured, thickly padded, nonslip strap is now the industry standard for briefcases, notebook cases, sports bags and luggage. An ergonomic design ensures proper load distribution and comfort, and there are tough, welded-metal, full-rotation clips. One size fits all .....**16.95**

### Belt & Buckle (LOBBZ)

Give your shoulders a break! The Belt & Buckle slips through the loops on many Lowepro bags, distributing weight to your hips for comfortable, hands-free carrying and stability on rough ground. It provides additional security by keeping the load close to your body. One size fits all .....**7.95**

### Trekker DayPack II (LODPT2)

A versatile daypack for your sweater, jacket and snacks. It can be used on its own or can be fastened to the front of the Trekker AW II for extra storage capacity. It's outer fabric is made from water-resistant 600D ripstop nylon. Dimensions are 12.5 x 3 x 18" .....**36.95**

### Trekker FilmPack (LOFPT)

For Trekker backpacks. A see-through, zippered pouch to organize exposed and unexposed film and other small accessories. It can hold up to 20 rolls of 35mm film (in canisters) or 32 rolls of 120/220 film (out of the box). It's interior dimensions are 6 x 2 x 7.5" (WDH) .....**7.95**

### Backpack Harness (LOBPH)

Carries a fully loaded Professional AW or large Nova AW bag in an upright position. The CollarCut straps and 2-way adjustable sternum strap are ergonomically designed to distribute weight for greater comfort .....**29.95**

### Topload Zoom Chest Harness (LOCHB)

A harness for active outdoor sports photographers, with maximum security and stability for all Lowepro Topload Zoom holster-style packs (except the Topload Zoom Mini). Adjusts four ways for a perfect fit .....**9.95**

### Cinch Straps (LOSCSF)

Used to keep secure and stabilize loads carried on S&F waistbelts or SlipLock base products. Adjustable length up to 19" .....**9.95**

### PC Runner (LOPCRB)

Fasten this streamlined notebook case to the Road Runner AW or carry it separately. It includes a removable, adjustable, non-slip shoulder strap, and holds a large notebook. Its interior size is 13 x 1.75 x 11" (WDH); its exterior dimensions are 14 x 2.5 x 11.5" (WDH) .....**22.95**



BAGS

577

ORDER & INFO. (212) 502-6340 • FAX: (212) 239-7770 (800) 947-7008  
**1-800-290-6750 • www.bhphotovideo.com**



# OP/TECH

## STRAPS

BAGS

578

### Bin/Op Strap (OPSB0B)

A stylish and comfortable carrying system for compact binoculars and cameras with two connection points. It's adjustable from 8-15", and uses 1/4" webbing to attach to the connection area.....9.95

### Cam Strap

The perfect wrist strap for small point-and-shoot cameras, binoculars, or any other small item. The slide on the neoprene secures the strap snugly around the wrist. Adjustable from 8" to 15". It uses 1/4" webbing to attach to the connection area.....8.50

### Mini Loop Strap

A snap to attach and a comfort to wear. It's the ideal strap for carrying cameras, binoculars or light meters with only one connection point. It uses a small cord which can be threaded through a tight connection area and measures 16 1/2" in length.....8.95

### Cinch Strap

A versatile strap for all small cameras, binoculars or light meters. The 1/4" webbing can be fed easily through single, double or channel connection areas. Cinch Strap allows equipment to glide back and forth on the strap, remaining balanced at all times. It's adjustable from 9" to 23".....9.95

### Mini Loop Strap-QD (OPSM1QDB)

Easily adjustable using a unique slide. It includes a small quick disconnect (QD) for added convenience. It's adjustable from 17-25" and can be worn comfortably around the neck or shoulder.....9.95

### Cam Strap-QD

Featuring a small quick disconnect, the Cam Strap-QD allows you to quickly switch to the Mini Loop Strap-QD. It secures comfortably around the wrist and measures 10" long.....9.50

### Gotcha Wrist Strap

Neoprene wraps comfortably and snugly around the wrist while 3/8" webbing attaches easily to the camera. The wrist size adjusts from 7" to 9 1/2" and the webbing is from 5" to 14". A quick disconnect offers added convenience .....8.95



### Fashion Strap

The original neoprene strap is designed with comfort in mind. It fits most cameras and binoculars with a patented connection system that's easy to attach. It adjusts from 39" to 44" and has quick disconnects for added convenience.....14.95

### Fashion Strap-3/8"

Same as the Fashion Strap; however, it uses 3/8" webbing for tight connections and is adjustable from 30" to 58" .....15.95

### Fashion Strap Bino Version

Similar to the Fashion Strap, this strap does not have quick disconnects and measures from 24" to 45" using 3/8" webbing for tight connection areas ..14.95

### E-Z Comfort Strap

Combines high quality neoprene, leather and 3/8" webbing to form a simple, yet comfortable strap. The slim design and easy-to-use connection system make this a great strap for binoculars and cameras. Adjustable from 22"-44" .....9.95

### Classic Strap

The tailored design neck/shoulder strap combines neoprene with "Comfort-Stretch Binding". It attaches easily with 3/8" webbing and offers quick disconnects for added convenience. It's adjustable from 30" to 58" .....17.95

### Super Classic Strap

Same tailored design as the Classic Strap; however, it adds a patented internal control-stretch system and Non Slip Grip. Ideal for carrying a heavy camera, binoculars or power pack. Available in 3/8" connectors (30"-58") or Pro Loop connectors (42"-48").....19.95

### The Pro Strap-3/8"

The choice of pros. The weight reduction system and Non Slip Grip features make it absolutely essential for prolonged use of heavy cameras and power packs. It's fully adjustable from 28 1/2" to 56 1/2" .....19.95

### Pro Loop Strap

Same comfort as the Pro Strap-3/8" but it uses a unique loop connector for tight camera connection points. Fully adjustable from 40" to 46" .....19.95



For Any Inquiries Regarding Your Order, Call Our Customer Service:  
(800) 221-5743 • (212) 239-7765 • FAX: (800) 947-2215 • (212) 239-7549

## STRAPS

BAGS

579

### Reporter Strap (OPSR)

Great for today's active photographers and wildlife enthusiasts. Comfortably carry two cameras or a camera and binoculars at the same time, which allows you to have better control of your equipment and reduces the chance of damage. The primary strap is adjustable from 28½" to 56½" and attaches with quick disconnects to the main body of the strap. The secondary strap is adjustable from 30" to 38" and attaches with snap hooks to D-Rings located on the main body of the strap. Both connection systems use the 3/8" webbing to attach to your gear .....**20.95**



Reporter Strap



Mini S.O.S. Strap



S.O.S. Strap

### Stabilizer Strap (OPSSB)

Keep your camera close to your body so you're free to enjoy hiking, climbing, biking, etc. It incorporates a quick disconnect to easily attach on and off. For quick access to your camera, merely stretch the neoprene over the lens. Adjustable from 19" to 55" .....**14.95**



Stabilizer Strap

### Grip Strap (OPSGB)

A secure system for carrying your camera in your hand. Simply attach the metal base plate to the tripod mount area and secure the Grip Strap to your camera connection area. It adjusts to fit snugly across the back of the hand as well as snaps comfortably around the wrist. Security and convenience in one ..**26.95**



Tripod Strap

### Super Pro Strap (OPSSP)

Finally, you can benefit from Op/Tech's weight reduction system and Non Slip Grip on your medium format and 35mm cameras with retaining lugs. Super Pro Strap is available in a choice of two metal clip designs. Once the clip is attached, the unique plastic locking slide mechanism is slid in place to secure the clip and protect the camera's finish. Super Pro Strap is fully adjustable from 40" to 48" .....**19.95**



Grip Strap

### Utility Strap (OPSUB)

For small bags, battery packs and more. It incorporates neoprene internal support foam, 3/4" webbing, quick disconnects and rugged locking swivel clips. Fully adjustable (approximately 44 - 58") .....**19.95**

### Utility Strap with 3/8" Connector

Similar to the standard Utility Strap, this version features 3/8" webbing connectors and is adjustable from 28.5 - 56.5" .....**CALL**

### Mini S.O.S. Strap (OPSSOSM)

The "Save On Shoulders" strap offers a unique internal control-stretch system along with a non skid surface. Attaches with metal swivel hooks or 1" webbing. Adjustable from 20" to 52" .....**16.95**

### S.O.S. Strap (OPSSOSB)

Same as above with 1½" webbing.....**19.95**

### Bag Strap (OPSB)

A soft, durable neoprene pad with comfort-stretch backing make bags feel 50% lighter. For small to medium weight bags. It offers metal swivel hooks and is adjustable from 27" to 52" .....**22.50**

### Tripod Strap (OPST)

With thick neoprene padding, this tripod strap is very easy on your shoulder. Simply attach one side near the neck of the tripod, and the other at the base of the legs. Fully adjustable from 15" to 44" .....**19.95**

### Tripod Leg Wraps (OPTLW)

Wraps each leg individually to protect the legs against damage and to give you added comfort against shoulder fatigue. It also keeps the cold metal legs "under wraps" and away from your skin. Available in three sizes: 1", 1¼", 1½" diameter leg sizes. The 17" foam can be cut to fit your needs.....**26.95**

## SYSTEM CONNECTORS

Now you can customize your strap to better suit your needs. Straps can be lengthened to be worn across the chest or shortened to be worn at chest level. Sets of 2.



**Swivel Hook Connectors (OPSCSH):** 11"-17.5" each side.....**8.50**

**Adjustable Connectors (OPSCA):** 7.5"-10" each side.....**7.50**

**3/8" Web Connectors (OPSC38):** Comes standard with most straps. 3"-17" each side .....**7.50**

**Pro Loop Connectors-1/4" Webbing (OPSCPL):** 9"-12" each side .....**8.50**

**Super Pro Connectors-A Design (OPSSPA):** 9"-13" each side.....**19.95**

**Super Pro Connectors-B Design (OPSSPB):** 9"-13" each side.....**19.95**

# OP/TECH

## POUCHES

BAGS

580



### Soft Pouch - Zippeez/Small (OPPZSS)

Main pouch is 4 x 2.75 x 1". The front pocket has a depth of 1/2" .....**14.95**

### Soft Pouch - Zippeez/Medium (OPPZSM)

Main pouch is 4.5 x 3 x 1.5". The front pocket has a depth of 1/2" .....**16.95**

### Soft Pouch - Zippeez/Large (OPPZSL)

Main pouch is 5.5 x 3.5 x 1.75". The front pocket has a depth of 1" .....**18.95**

*Both the Medium and Large sizes come with small D-rings so that you can attach a strap to the pouch if desired.*

### Soft Pouch - Digital D-Series

These easy-access protective neoprene cases will fit most film and digital cameras. They are great for use in the field as the case closes around the neck strap so that it's still usable to carry your camera. Each case offers a unique retaining strap that attaches around the lens (D-Compact and D-Small have a snap hook lanyard that attaches to the camera or strap).



**D-Small (OPDDSPB):** Fits most cameras measuring 4.5 x 3 x 3.25" with a large grip....**CALL**

**D-Compact (OPDDCPB):** Fits a wide range of cameras measuring 4.8 x 3.5 x 3" .....**18.95**

**D-Offset (OPDDOPB):** Fits most cameras measuring 4.9 x 3.5 x 4.6" with an offset design .....**18.95**

**D-SLR (OPDDSLRPB):** Fits most SLR cameras without battery packs that measure 6 x 4.5 x 6" with a maximum lens size of 3 3/4" diameter x 4.5" long.....**22.50**

**D-SLR Zoom (OPDDSLRZPB):** Fits the same SLRs as the D-SLR; however it will fit longer lenses measuring up to 6" in length. Overall dimensions are 6 x 4.5 x 8" .....**26.95**

**D-Pro (OPDDPPB):** Fits most film and digital SLRs with battery packs that measure 6 x 6.5 x 6" and a maximum lens size of 3 3/4" diameter x 4.5" long.....**29.50**

**D-Pro Zoom (OPDDPZPB):** Fits the same SLR/battery pack combinations as the D-Pro with longer lenses up to 6" in length. Overall dimensions are 6 x 6.5 x 8" .....**32.50**

### Soft Pouch SLR and Rangefinder

These pouches provide great protection while conforming snugly to fit a large variety of cameras. These easy-access cases are made of soft, durable neoprene to provide protection in case of impact and to repel water in inclement weather. They feature a quick-release attachment and a retaining strap that keeps the case attached to the camera at all times while enabling it to fall easily away from the field of view. SLR pouches are available in black, royal blue, steel and forest green colors. Rangefinder available in black only.



**SLR Manual (OPPM SLR):** Fits most cameras measuring 5.5 x 3 x .75" with a standard 50mm lens .....**22.95**

**SLR Auto (OPPAFSLRSZB):** Fits most cameras measuring 6.1 x 3.5 x 4.9" with 28-80 or 35-80mm lenses .....**24.95**

**SLR AF-Zoom (OPPAFSLRLZ):** Fits cameras measuring 6 x 3.5 x 6.25" with 28-200 or 28-210mm lenses .....**26.95**

**SLR AF-PRO (OPPAFPSLR):** Fits most camera/lens combos measuring 6 x 6 x 6" with extended power drives.....**29.95**

**Rangefinder (OPSPRB):** Fits most viewfinder cameras and some manual SLRs measuring 5 1/2 x 3.1 x 4" .....**22.50**

**Rangefinder-Telephoto (OPSPRTB):** Accommodates a zoom lens measuring up to 2 3/4" diameter and 4 1/2" length ....**26.95**

### Hipster Pouches

Ideal protection for your film or digital camera. The horizontal design securely attaches to a belt for easy access and convenience while a shoulder strap is included for added versatility. The neoprene inner panel between the pouch and the front pocket allows for expansion when needed. The handy front pocket offers additional storage for media cards, batteries and more.

**Small Hipster Pouch (4801114):** 4 x 3 x 1" .....**CALL**

**Large Hipster Pouch (4801134):** 5 1/2 x 3.5 x 1 3/4" ....**CALL**

**Medium Hipster Pouch (4801124):** 4 1/2 x 3 1/2 x 1 1/2" ....**CALL**

**X-Large Hipster Pouch (4801144):** 6 x 4 x 2 1/2" ....**CALL**



EQUIPMENT LEASING AVAILABLE



## POUCHES & WRAPS

### SOFT POUCH PHOTO/ELECTRONICS and PDA/CAM

This line of easy-access cases is made of soft, durable neoprene to provide protection on impact and to repel water in inclement weather. Soft Pouches offer great protection while conforming snugly to fit a large variety of items such as cameras, lenses, light meters, personal organizers, binoculars, glasses and more. All versions offer a unique clip that has a strong retaining lip as well as a patented locking device to securely attach it to your belt, backpack or other areas. The PDA/CAM versions offer an option of a swivel clip. This clip allows the pouch to move from side to side so that it's never in the way while sitting.

| Style         | Approx. Measurements | Clip Options      | Price |
|---------------|----------------------|-------------------|-------|
| Mini          | 2.5 x 4 x 1"         | Locking           | 10.95 |
| PDA/CAM-Micro | 3.375 x 5.25 x 1"    | Locking or Swivel | 12.50 |
| PDA/CAM-Macro | 3.75 x 5.75 x 1"     | Locking or Swivel | 12.50 |
| Small         | 2.5 x 6 x 1"         | Locking           | 11.95 |
| Medium        | 3 x 6 x 1.5"         | Locking           | 12.95 |
| Large         | 4 x 7 x 1.5"         | Locking           | 13.95 |



### Soft Pouch Body Cover

Ideal protection for your camera body while in storage. The form-fitting neoprene cover protects against dust, moisture and impact so there's no worry when putting it in a large camera bag full of other items. For the avid photographer who frequently carries several lenses and camera bodies, the Body Cover for cameras and Snoot Boot for lenses combine to make a great protective storage system.



**Auto Soft Pouch Body Cover (OPSBCB):** Fits most autofocus SLR bodies measuring 6 x 4.5 x 3" .....**19.95**

**AF-Pro Soft Pouch Body Cover (OPSPBCB):** Fits autofocus SLR bodies with extended power drives measuring 6 x 6.5 x 3" .....**22.50**

**Manual Soft Pouch Body Cover (820114):** Fits most manual SLR or rangefinder bodies measuring 5.75 x 3.1 x 2" .....**CALL**

### Snoot Boot

Snoot Boot is no ordinary lens pouch. It has a cylindrical design with a wide-mouth opening for easy access. It offers a drawstring closure, belt loop and snap hook. It is a convenient alternative for carrying a small camera or other items. "WB" wide-body sizes are available for wider lenses.



**Mini Snoot Boot (7801262):** 3x 4" .....**12.95**

**Small Snoot Boot (7801112):** 3.2 x 6" .....**13.95**

**Medium Snoot Boot (7801122):** 3.5 x 8" .....**14.95**

**Large Snoot Boot (7801132):** 3.6 x 9" .....**14.95**

**WB-Small Snoot Boot (7801162):** 4 x 5" .....**14.95**

**WB-Medium Snoot Boot (7801152):** 4.5 x 6.5" .....**14.95**

**WB-Large Snoot Boot (7801142):** 4.5 x 8" .....**14.95**

### Lens/Filter Pouch

These pouches provide an easy-access carrying system for your lens and filters. It offers two protective sections to better organize and safeguard your gear. A zippered section with a padded protective divider holds two filters and a wide-mouth lens section offers added convenience and accommodates larger lenses with sunshades. A drawstring closure, padded dust flap, snap attachment and belt loop add the finishing touches.



**Small Lens/Filter Pouch (OPPLFS):** 4" Ø x 5" L .....**15.95**

**Medium Lens/Filter Pouch (OPPLEM):** 4.5" Ø x 7" L .....**16.95**

**Large Lens/Filter Pouch (OPPLFL):** 4.5" Ø x 9" L .....**17.95**

### Soft Wraps

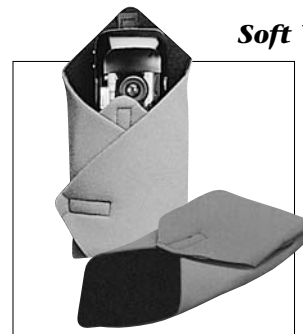

Soft Wraps provide extra protection for lenses, cameras, binoculars, light meters, small tripods, and other accessories. They offer an extra 5" pad within the wrap which can be moved around to provide extra protection where needed. Soft Wraps are available in a combination of black/red, black/royal, black/steel and black/forest green colors, making equipment easily identifiable.

**19" Soft Wrap (OPSW19)** .....**13.50**

**15" Soft Wrap (OPSW15)** .....**12.50**

**11" Soft Wrap (OPSW11)** .....**9.95**

# OP/TECH

## ACCESSORIES

BAGS

582

### Accessory Pack (4901002)

A full-access zippered case that is ideal for storing, organizing and protecting all types of gear from PDAs, MP3 players, cameras, lenses, cables, batteries and more. Five removable padded dividers and two clear pockets offer ideal versatility and protection. Includes a webbing shoulder strap and measures 8 x 5 x 2.5".....CALL



### Retrieve-It (OPRI)

A secure system for carrying a camera, binoculars, phone, and much more. It attaches easily with a choice of split rings or snap hook. The nylon-coated stainless steel cable extends up to 30" so that you can easily use your gear. It will fully retract an item weighing up to 6 ounces; however, it can secure an item weighing up to 10 lbs. in the fully-extended position. Dimensions are 1.5" ø x .5" ...8.50



### Strapeez (OPSBQ)

Organize power cords, computer cables, ropes, tools and other items. Strapeez have a unique attachment system which easily adheres to itself or to other Strapeez, to create a longer length. Contains 6 per bag, each strap measures 8" in length.....6.50



### Filter Pack (OPFP77)

A secure system for carrying extra filters up to 77mm. The easy-access neoprene case contains two filter pockets and offers a snap hook for easy attachment to a variety of equipment/gear or clothing. The protective pockets are lined with a micro fiber suede .....9.50



### Fast Cap (OPFC)

There's no other lens cover like it! It screws into the camera lens or filter and opens with a flick of your thumb. Available in sizes 49, 52, 55, 58, 62, and 67mm .....7.50



### Filter Cap (OPFC58Q)

Block out dust and moisture and stack a filter without having to remove your lens cover. Filter Cap is held in place by the filter of your choice, and enables you to stack an additional filter on top without causing any vignetting. Available in 49, 52, 55, 58, 62, 67, 72mm...7.50



### Soft Pouch Sport Pac (OPSPB)

A comfortable way to carry a compact camera, binoculars or other items while enjoying outdoor activities. Waist band extends to 45" using Velcro to adjust and a quick-release buckle for easy attachment .....22.50



### Hood Hat

Protects your lens when using a hood or sunshade. The neoprene Hood Hat slides over the sunshade to protect the lens from dust, moisture and impact. Fits Ø ± 1/4".



**3" Mini Hood Hat**  
(OPHHMQ) .....7.95

**4.5" Large Hood Hat**  
(OPHHL).....8.50

**3.5" Small Hood Hat**  
(OPHHS).....7.95

**5" X-L Hood Hat**  
(OPHHXL).....9.50

**4" Medium Hood Hat**  
(OPHHM) .....8.50

**5.75" XX-L Hood Hat**  
(OPHHXXL).....9.95

### X-Ray Pouch

Extra protection for film and other sensitive medium (up to 1000 ISO) against the effects of airport security systems. The flexible lead liner is captured between two layers of durable nylon fabric. Full flap Velcro closure provides easy, secure access.



**Small X-Ray Pouch (OPXRPS):** Measures 5.5 x 8" and holds up to 9 film canisters (14 rolls), several disks or a compact camera .....18.95

**Medium X-Ray Pouch (OPXRPM):** Measures 8.25 x 10" and holds up to 20 film canisters (30 rolls), two 50 sheet boxes of 4 x 5" film, compact cameras, or smaller cameras .....25.95

**Large X-Ray Pouch (OPXRPL):** Measures 12 x 14" and holds a laptop computer, up to 70 film rolls, two bricks of film (40 boxes), four 100 sheet boxes of 4 x 5" film, compact or SLR cameras.....32.95

### WeatherGuard

A unique protective cover for cameras and motor drives with large lenses. The removable supports enable you to roll up the WeatherGuard so that it can be easily carried. Constructed of a waterproof, Urethane-coated ripstop nylon on the outer layer and a nonreflective Velcro UBL material on the inside. Available in black (OPWG18B) or light gray (OPWG18G) .....69.95



### Bino/Cam Harness

Perfect for binoculars or cameras. It stabilizes gear against your body while enabling it to glide up and down the strap during use. Unique loop attachments allow you to quickly snap the harness in place.  
**Elastic Bino/Cam Harness (OPHE) .....19.95**  
**Webbing Bino/Cam Harness (OPH) .....12.50**



### Soft Pouch Sport Harness (OPPSHB)

This hands-free, two-pocket neoprene harness protects phones, cameras and more while stabilizing them snugly against your body. The breathable back panel and expansion system offer increased comfort while side release buckles make it a snap to attach.....29.95



# PELICAN

## HARD WATERTIGHT CASES

### Watertight Equipment Protector Cases

The world's toughest protector cases, Pelican cases are built to perform in the most severe condition. Designed for active photographers and backed by an unconditional lifetime guarantee, the cases are watertight and airtight to 30', dustproof, corrosion proof and unbreakable, for the ultimate in protection. Constructed of lightweight space-age structural resin with a neoprene o-ring seal and exclusive purge valve, most cases are supplied complete with pre-scored pick 'n' pluck foam or padded dividers (no cutting required), but are also available without the foam. They also include locking flanges, massive multiple latches for absolute security and a comfortable molded fold down handle.



- ◆ Exclusive 1/4" neoprene o-ring guarantees a perfect seal. Neither dust or water can penetrate this barrier.
- ◆ Built-in o-ring sealed pressure purge valve allows for quick equalization after changes in altitude or temperature.
- ◆ Incredibly light structural foam resin shell always looks new, and is unaffected by dents, scratches or corrosion.
- ◆ Prescored "pick-n-pluck" foam or padded dividers protect even the most sensitive equipment.
- ◆ Cases far exceed the highest standards of industrial, airline, military and commercial applications:  
Stacking: 400 lbs.; Drop Test: 48"  
Humidity: 120° F;  
Immersion: 2" at 160°F



BAGS

583

### HARD CASES

| Model | Interior (LxWxD)           | Outside (LxWxD)            | Colors                              | With Dividers      | With Foam           | Without Foam         |
|-------|----------------------------|----------------------------|-------------------------------------|--------------------|---------------------|----------------------|
| 1120  | 7" x 4" x 3 1/2"           | 8" x 6" x 3 1/2"           | Black, Silver, Blue, Orange, Yellow |                    | PE1120F .....18.21  | PC1120NF .....14.79  |
| 1150  | 8" x 5" x 3 1/2"           | 9" x 7" x 4"               | Black, Silver, Blue, Orange, Yellow |                    | PE1150F .....21.06  | PC1150NF .....18.21  |
| 1200  | 9" x 7" x 4 1/2"           | 10" x 9 1/2" x 4 1/2"      | Black, Silver, Yellow, Orange       |                    | PE1200F .....31.50  | PC1200NF .....25.79  |
| 1300  | 9" x 7" x 6"               | 10" x 9 1/2" x 6"          | Black, Silver, Yellow, Orange       |                    | PE1300F .....38.50  | PC1300NF .....30.75  |
| 1400  | 12 x 9 1/2 x 5 1/2"        | 13 1/2 x 11 1/2 x 6"       | Black, Silver, Yellow, Orange       |                    | PE1400F .....54.50  | PC1400NF .....46.71  |
| 1420  | 13 x 5 x 10"               | 15 x 8 1/2 x 10 1/2"       | Black                               |                    | PE1450F .....46.71  |                      |
| 1450  | 14 1/2" x 10" x 6"         | 16 x 13 x 6"               | Black, Silver, Yellow, Orange       | PC1454 .....93.95  | PE1450F .....66.95  | PC1450NF .....61.53  |
| 1470  | 15 1/2" x 10" x 3 3/4"     | 16 1/2" x 13 1/2" x 4 1/2" | Black Only                          |                    | PC1470F .....79.77  | PC1470NF .....74.07  |
| 1490  | 17" x 11 1/2" x 4"         | 19 1/2" x 13 1/2" x 4 1/2" | Black Only                          |                    | PC1490F .....94.59  | PC1490NF .....87.18  |
| 1500  | 17 x 11 1/2 x 6"           | 18 1/2 x 14 1/2 x 6 1/2"   | Black, Silver, Yellow, Orange       | PC1500 .....101.50 | PC1500F .....77.95  | PC1500NF .....71.79  |
| 1510  | 17 x 11 1/2 x 6"           | 18 1/2 x 14 1/2 x 6 1/2"   | Black, Silver, Yellow, Orange       | PC1510 .....144.95 | PC1510F .....119.95 | PC1510NF .....99.95  |
| 1520  | 17" x 12" x 6"             | 19" x 15" x 7 1/2"         | Black, Silver, Yellow, Orange       | PC1520 .....117.50 | PC1520F .....87.99  | PC1520NF .....76.92  |
| 1550  | 18 1/2" x 14 1/2" x 7"     | 20 1/2" x 17 1/2" x 8"     | Black, Silver, Yellow, Orange       | PC1550 .....143.50 | PC1550F .....98.95  | PC1550NF .....86.04  |
| 1600  | 21" x 16 1/2" x 7"         | 24" x 19" x 8 1/2"         | Black, Silver, Yellow, Orange       | PC1600 .....162.50 | PC1600F .....116.95 | PC1600NF .....97.95  |
| 1610  | 22 1/2" x 17" x 10 1/2"    | 24 1/2" x 19" x 11 1/2"    | Black                               | PC1610 .....193.50 | PC1610F .....149.95 | PC1610NF .....129.95 |
| 1620  | 22 1/2" x 17" x 12 1/2"    | 24 1/2" x 19" x 13"        | Black                               | PC1620 .....264.95 | PC1620F .....164.95 | PC1620NF .....142.47 |
| 1650  | 29 x 17" x 10 1/2"         | 32 1/2 x 20 1/2 x 11 1/2"  | Black                               | PC1650 .....237.50 | PC1650F .....173.95 | PC1650NF .....148.17 |
| 1660  | 29" x 20" x 17"            | 31 1/2 x 22" x 18"         | Black                               | PC1660 .....339.95 | PC1660F .....234.95 | PC1660NF .....210.87 |
| 1700  | 35 1/2" x 13 1/2" x 5 1/2" | 38" x 17 1/2" x 6"         | Black                               |                    | PC1700F .....135.95 | PC1700NF .....124.80 |
| 1750  | 50" x 13 1/2" x 5 1/2"     | 53 x 17 1/2" x 6 1/2"      | Black                               |                    | PC1750F .....155.95 | PC1750NF .....145.32 |

ORDER & INFO. (212) 502-6340 • FAX: (212) 239-7770 (800) 947-7008  
1-800-290-6750 • www.bhphotovideo.com



# PELICAN

## HARD WATERTIGHT CASE ACCESSORIES

BAGS

584

### HARD CASE ACCESSORIES

| CASE | Replacement Pick 'N' Pluck Foam |       | Replacement Padded Dividers |        | Replacement O-Rings |      |
|------|---------------------------------|-------|-----------------------------|--------|---------------------|------|
| 1120 | PEFS1120                        | 5.10  |                             |        | PEOR1120            | 1.29 |
| 1150 | PEFS1150                        | 5.67  |                             |        | PEOR1150            | 1.59 |
| 1200 | PEFS1200                        | 7.95  |                             |        | PEOR1200            | 1.85 |
| 1300 | PEFS1300                        | 9.66  |                             |        |                     |      |
| 1400 | PEFS1400                        | 13.65 |                             |        | PEOR1400            | 1.85 |
| 1420 |                                 |       |                             |        | PEROR1420           | 2.19 |
| 1450 | PEFS1450                        | 15.93 | PEDS1450                    | 36.77  | PEOR1450            | 2.22 |
| 1470 | PEFS1470                        | 10.40 |                             |        | PEOR1470            | 2.25 |
| 1490 |                                 |       |                             |        | PE1493              | 2.14 |
| 1500 | PEFS1500                        | 18.78 | PEDS1500                    | 43.46  | PEOR1500            | 2.25 |
| 1510 | PEFS1510                        | 32.95 | PEDS1510                    | 67.95  | PEOR1510            | 3.95 |
| 1520 | PEFS1520                        | 24.48 | PEDS1520                    | 58.11  | PEOR1520            | 2.42 |
| 1550 | PEFS1550                        | 30.18 | PEDS1550                    | 74.95  | PEOR1550            | 2.54 |
| 1600 | PEFS1600                        | 41.01 | PEDS1600                    | 79.20  | PEOR1600            | 2.65 |
| 1610 | PEFS1610                        | 43.29 | PEDS1610                    | 82.62  | PEOR1610            | 2.65 |
| 1620 | PEFS1620Q                       | 35.88 | PEDS1620                    | 133.35 | PEOR1620            | 2.91 |
| 1650 | PEFS1650                        | 48.42 | PEDS1650                    | 92.31  | PEOR1650            | 4.99 |
| 1660 | PEFS1660                        | 71.22 | PEDS1660                    | 140.19 | PEOR1660            | 4.53 |
| 1700 | PEFS1700*                       | 30.18 |                             |        | PEOR1700            | 3.11 |
| 1750 | PEFS1750*                       | 37.59 |                             |        | PEOR1750            | 5.50 |

\*Solid foam only

#### Photographer's Lid Organizer (PELOP)

For the 1500 and 1520 hard cases. Holds film, filters, gadgets, notes. Fits cases #1500 and #1520. Made of waterproof Ballistic Nylon, nylon zippers, mesh pockets. Installs with Velcro strip (included). Size: 16<sup>3</sup>/<sub>8</sub> x 10<sup>1</sup>/<sub>2</sub>" .....14.79

#### Attaché Lid Organizer (PELOA)

For the 1500 and 1520 hard cases. Holds paper, pens, calculator, manuals, and files. Made of waterproof Ballistic Nylon, it has nylon zippers and mesh pockets. It installs with Velcro strip (included). Size: 16<sup>3</sup>/<sub>8</sub> x 10<sup>1</sup>/<sub>2</sub>" .....15.36

#### Lid Organizer (PELO1600)

For the 1600, 1610 and 1620 hard cases. Designed to hold film, filters, and more. Made of waterproof ballistic nylon with nylon zippers and a multitude of pockets. Installs easily with included Velcro strips. Dimensions are 27 x 17" .....22.77

#### Lid Organizer (PELO1650)

For the 1650 hard case. Size: 27 x 17" .....23.91

#### Attaché Lid Organizer (PELO1660)

Installs into the 1660 hard case with 6 mounting screws. Many pockets in various sizes protect your gear: cameras, lens, film, light meters, etc. Size: 20 x 28.5" .....46.95

## SOFT SIDED SERIES CASES

Pelican Soft Sided Series Cases are constructed of high quality materials and hardware inside and out for durability and ease of use. They are an excellent choice for carrying a variety of camera and lighting equipment.

#### PCS145 (PESB1450)

##### Soft Bag for 1450 Case

Opening from the top or side, the PCS145 features expandable outer side pockets, interior and exterior mesh pockets, an elastic shock cord for carrying a tripod, a removable padded shoulder strap and adjustable padded backpack straps. It holds an SLR and up to 4 lenses and accessories. It meets all FAA carry-on requirements and fits into the 1450 hard case .....74.95

#### PCS152 (PESB1520)

##### Soft Bag for 1520 Case

Same as the PCS145 with removable adjustable tripod straps for extra support. It holds 1 to 2 SLR's, up to 5 lenses and accessories. It fits into the 1520 hard case .....99.95

#### PCS155 (PESB1550)

##### Soft Bag for 1550 Case

Same as the PCS152 with more room. It holds 1 or 2 SLR's and up to seven lenses. It fits into the 1550 hard case .....109.95



#### PCS140 (PESB1400)

##### Soft Bag for 1400 Case

This case holds one SLR with 2 lenses and accessories. It opens from the top or side and has front and side pockets, an adjustable fanny pack and a removable shoulder strap. The PCS140 is FAA carry-on compatible and fits into the 1400 hard case.....45.95

#### PCS1501 (PESB1500)

##### Soft Bag for 1500 Case

A soft-sided case that fits into a 1500 shell. It holds an SLR with an attached lens up to 7" long, 3 lenses, flash, film and accessories. It opens from the top or side, has interior mesh pockets, an elastic shock cord, a padded carry handle, a removable shoulder strap plus a front pocket organizer, movable dividers, heavy duty zippers and durable hardware. Airline carry on compatible.....58.50



EQUIPMENT LEASING AVAILABLE

# PELICAN

## SOFT SIDED SERIES CASES

### PCS1522 (PESB1520NF)

#### Soft Bag for 1520 Case

An airline carry-on case that accepts an SLR with an attached lens up to 9½" long, a second SLR body, 5 lenses, flash, film, and accessories. It features a front pocket organizer with multiple pockets, and a full length divider that keeps a thin laptop computer or documents separate from the camera equipment.....68.50

### PCS1552 (PESB1550NF)

#### Soft Bag for 1550 Case

Similar to the PCS1522, this case fits into a 1550 case.....79.95

### PCS161 (PESB1610)

#### Wheeled Soft Bag for 1610 Case

Holds an SLR or medium format system and accessories. It has a large outer pocket for a cloth background; multiple mesh pockets for accessories, and a removable inner tray with handles and multiple padded dividers in the main compartment. Inline skate wheels and a retractable locking handle make this case roll with ease ..229.95

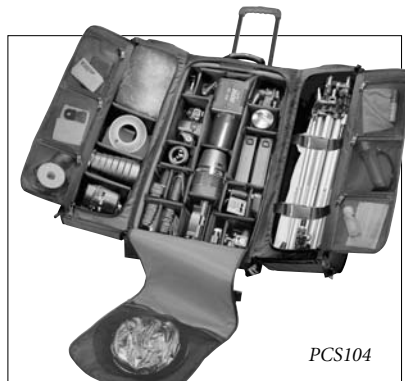

PCS104

### PCS104 (PELCWC)

#### Lighting and Camera Equipment Wheeled Case

Holds an SLR, medium format or lighting equipment in a removable divider tray set. Two flip top compartments hold light stands, umbrellas, tripods and other accessories and offer easy access even when the case is closed. Two grab handles, inline skate wheels, stairguard, compression straps and a retractable locking handle make moving equipment a snap. Adjustable straps and catch pockets on both sides secure larger tripods and light stands.....324.95



PCS1522

PCS161

PCS172

### SOFT CASES

| Model   | Interior (LxWxD) | Outside (LxWxD) |
|---------|------------------|-----------------|
| PCS104  | 27 x 7 x 5½"     | 28 x 17 x 14"   |
| PCS140  | 10¼ x 8½ x 3½"   | 11½ x 9 x 5½"   |
| PCS145  | 12 x 9 x 5½"     | 14 x 10 x 5½"   |
| PCS152  | 14½ x 11 x 5½"   | 17 x 12½ x 6½"  |
| PCS155  | 15½ x 11¼ x 6"   | 18¾ x 13¼ x 7"  |
| PCS1501 | 15 x 9½ x 3½"    | 16 x 10½ x 5"   |
| PCS1522 | 16 x 10 x 4½"    | 17½ x 11 x 6"   |
| PCS1552 | 16½ x 11½ x 4½"  | 17½ x 12½ x 6½" |
| PCS161  | 17 x 14¼ x 6"    | 20½ x 16¼ x 9¼" |
| PCS172  | 16½ x 12 x 7½"   | 17 x 14 x 9½"   |

### PCS172 (PEBWC)

#### Pro Camera System/Notebook Computer Wheeled Case

Featuring inline skate wheels and a recessed telescoping handle, this airline carry-on compatible case will carry one SLR with an attached lens up to 10" long, a second camera body, up to 5 lenses, flash, film and accessories. The main case opens from the top or the side for easy access, has interior mesh pockets for accessories and a full length divider that separates the notebook computer compartment from the camera equipment. The removable notebook computer case can be used separately with the padded shoulder strap. Both cases feature organizer pockets for your accessories, keys, cell phone, etc.....152.95

### Shooting Vests

Full collar shooting vests with 14 usable pockets which contain impact protective foam lining to protect valuable equipment. It's strong, yet soft "NC" material (55% nylon, 45% cotton) is water and oil resistant.



Available in Black in 5 sizes:

Small (PEVSB), Large (PEVLB), Medium (PEVMB), Extra Large (PEVXLB), XX-Large (PEVXXLB).....74.50

Available in Tan in 4 sizes:

Small (PEVST), Medium (PEVMT), Extra Large (PEVXLT), and XX Large (PEVXXLT).....74.50

### ACCESSORIES

#### Desiccant Silica Gel (PE1500D)

Absorbs dampness and prevents condensation from trapped air when cases are opened in damp, high humidity climates. Fits all cases. ....9.95

#### Peli-Lock for all Cases (PEPL)

A brass number lock designed to safely guard your valuable equipment, and can be used with any Pelican case .....9.95

BAGS

585

ORDER & INFO. (212) 502-6340 • FAX: (212) 239-7770 (800) 947-7008  
1-800-290-6750 • www.bhphotovideo.com



# PORTER CASE

## TRAVELER SOLUTIONS

BAGS

586

Eliminate the hassles of carrying cumbersome gear on long walks through terminals and parking lots. Transport your gear in a hard-sided wheeled, carry-on with a built-in cart. To convert, simply pull two latch pins, fold to the CART position, stack your other baggage, and away you go.

Engineered to fit under airline seats and/or overhead compartments, they are constructed of ABS hard side plastic with 4" ball bearing wheels and a solid steel axle, a padded 41" extension handle with lock down feature, "side strap" handle, combination lock and two keyless latches, fully lined with a Velcro receptive non woven material, strong aluminum valance with three steel hinges, 72" webbed tie down strap and more.



### PC II CASES

**PC II Standard (PO1502E):** 22 x 14 x 8". With an elastic cross over strap with snap in the lid...**189.95**

**PC II Computer (PO1502ECD):** With a briefcase style accordion portfolio, snaps in the lid and a cloth covered padded computer ring with adjusting foam in the bottom.....**219.95**

**PC II Divider (PO1502EPD):** Same as as the PC II Standard with removable convoluted foam padding in the lid, 1/2" sheet of HD foam in the bottom, a fully adjustable cloth covered divider system, and wheel well foam brace. It fits two medium format size systems .....**229.95**

**PC II Deluxe Divider (PO1502PP):** Same as the PC II Divider, with a briefcase style accordion portfolio in the lid and an extra foam sheet to go between the lid portfolio and your equipment.....**239.95**

**PC II AV (PO1502EAVD):** The base case with a removable convoluted lid foam, a 1/2" HD foam sheet on the bottom and a cloth covered padded foam ring with an adjustable divider.....**209.95**

**PC II Foam (PO1502EF):** Like the Standard Case with four layers of medium density gray foam 1.25" thick each to fill the bottom and a removable convoluted foam sheet in the lid.....**199.95**



PC II Deluxe Divider

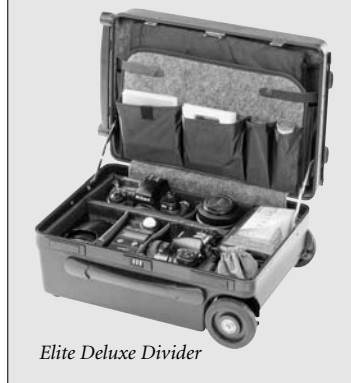

Elite Deluxe Divider

### ELITE CASES

**Elite Standard (PO1504E):** 18 x 13 x 8". With an elastic cross over strap with snap in the lid...**189.95**

**Elite AV/Computer (PO1504EAVD):** The base case with removable convoluted lid foam, a 1/2" high density foam sheet on the bottom and a cloth covered padded foam ring to hold a variety of equipment .....**199.95**

**Elite Computer (PO1504ECD):** Same as as the Elite Standard with a briefcase style accordion portfolio, snaps in the lid and a cloth covered padded computer ring with adjusting foam.....**199.95**

**Elite Divider (PO1504EPD):** With a removable convoluted foam padding in the lid, 1/2" sheet of high density foam in the bottom, and an adjustable cloth covered divider system. Holds one medium format system .....**215.95**

**Elite Deluxe Divider (PO1504PP):** Same as above with a briefcase style accordion portfolio in the lid and an extra foam sheet to go between the lid portfolio and your equipment .....**224.95**

**Elite Foam (PO1504EF):** Like the Standard Case with four layers of medium density gray foam 1.25" thick each to fill the bottom and a removable convoluted foam sheet in the lid.....**194.95**

### ROLLING SOFTIES



**Rolling Softie 160 (PORS160):** Designed to carry a notebook computer, Softies have semi-rigid, padded 1600 denier walls, six inline skate wheels spaced 14.5" apart, a 41" extension handle, big #10 zippers and 3 separate storage areas. The front area is an expandable pouch for a remote, cords, etc. When unzipped, the middle section shows a removable notebook case with a shoulder strap. The rear third area is 14.5 x 12.5 x 4" and comes with and an adjustable divider system that can easily be arranged to accommodate a variety of equipment .....**139.95**

**Rolling Softie 150 (PORS150):** Same features as the Rolling Softie 160, but more open in the rear compartment to accommodate a digital projector. Perfect for the professional speaker or corporate trainer .....**129.95**



# PORTER CASE

## TRAVELER SOLUTIONS



Stowaway 20-20

### STOWAWAY 20-20 Stackable Shipping Case

The Stowaway 20-20 is designed to meet the recommended ATA-300 specifications for airline shipping cases. Its construction is of Polyethylene plastic with aluminum valance, industrial heavy-duty twist latches, 3 spring-loaded loop handles, and lid stays with optional pluck foam on the inside. Up to 3 Stowaway 20-20 cases will nest on top of a PC II or Elite case when converted to the cart position to form a complete travel system for the professional frequent traveler.

- ◆ Spring-loaded side loop handles
- ◆ Chrome-plated high density twist latches
- ◆ Mil-grade high-density polyethylene
- ◆ Lid stays
- ◆ Fully cloth lines
- ◆ 20 x 20 x 13" exterior
- ◆ 20 x 20 x 12.5" interior
- ◆ Weighs 16 lbs.

Stowaway 20-20 (POSA2020LF).....CALL



Stowaway 20-20 shown on a PC II Case

BAGS

587

### Av Insert Kits

This is the same insert found in the AV cases, allowing your case to adapt to a variety of equipment. It comes with a 1/2" sheet of HD foam for the bottom, a large outer cloth covered padded ring with Velcro on the outside to grab the case walls and two partial rows of Velcro inside that allow you to adjust the semi-rigid divider as needed, plus a sheet of convoluted foam for the lid.

Av Insert for PC II AV Case (POAVI) .....39.50

Av Insert for Elite AV/Computer Case (AVELITE) .....CALL

### Computer Insert Kits

A do-it-yourself kit developed to customize the interior of the PC II and Elite Standard cases for computers, LCD projector, electronic equipment, or other valuables needing a number of compartments. It consists of three panels 21" long x 4" high made of a rigid coroplast covered with gray foam backed Velcro loop material, 12 strips of 4 x 2" 3M hook tape, a 2" sheet of high density foam for the bottom, a foam brace for in-between the wheel wells, a formed piece of convoluted gray foam for the lid and two 9 x 12 x 1" gray foam pillows to protect your computer. Replacement.

Computer Insert Kit for PC II Computer Case (PODKC1502C) ..29.95

### Photo Divider System

This is the same divider system that is used in Divider and Deluxe Divider cases. It includes convoluted gray foam for the lid, and a 1/2" high density foam sheet for the bottom, a 4.5" tall cloth-covered high density foam outer ring with a Velcro strip on the outside to grab the case walls, one large divider, four medium dividers and ten small dividers. All of the above are with Velcro and are adjustable.

Photo Divider System for Elite Cases (PHPKELITE) .....CALL

Photo Divider System for PC II Cases (PHPKPCII) .....CALL



Saddle Bag

Computer Insert Kit

### Foam Insert Kits

This kit consists of four layers of gray foam 1.25" thick cut to fit the bottom of the case with a sheet of convoluted gray foam for the lid. A generic kit for most any application. Simply lay what you want to protect on the foam layers, use a marking pen for an outline, and then with an electric carving knife, craft knife or scissors, cut out the shapes. Replacement.

Foam Insert Kit for Elite (FMELITE) .....CALL

Foam Insert Kit for PC II (POFL1502C) ....39.50

### Saddle Bags

Designed to double your carry-on capacity, saddle bags store your extra accessories or your jacket, overcoat, tickets, magazines, snacks, etc. The large handle slides over the cart handle of PCII or Elite Case. They feature black 400 denier double wall construction with light padding in between, a zippered main storage compartment, a smaller outside pouch with a Velcro security flap that will hold tabloid size papers, and an adjustable shoulder strap with grip.

Saddle Bag for Elite (SDLELITE)  
With a 4 x 17 x 14" main compartment and a smaller outside storage compartment .....19.95

Saddle Bag for PC II (POSB)  
With a 4 x 21 x 14" zippered main storage compartment, a smaller outside pouch with a Velcro security flap, and a third smaller pouch for quick in and out storage .....29.95



# ROADWIRED

## THE POD SQUAD/TECHNICAL POUCHES

BAGS

588

RoadWired combines the quality and style of the world's best luggage with the protection of an equipment case and adds innovative features to create the perfect bags. RoadWired products have been featured and recommended in over 100 national publications, and have been named best by many leading magazines. RoadWired backs the quality of their exquisite cases with a lifetime warranty against any manufacturing or material defects.

### The "Pod Squad"

**The Pod:** The ultimate camera and accessory carrying case, with over 20 pockets and compartments, including media and accessory organizers, flap pockets, bungee keepers, and a padded adjustable "Hammock". The winged outer pocket intelligently organizes accessories. Dual-height loops on the back panel allow it to be worn as a waist pack on your own belt. It is available in Black (ROCTPB), Titanium (ROCTPT), Navy (ROCTPBL), Yellow (ROCTPY), Red (ROCTPR), and Hunter (ROCTPH). 7 x 6.5 x 5" exterior; 6.5 x 4 x 3.5" main compartment capacity. Weighs 13 oz.....**39.95**

**Medium Pod Pouch:** A scaled-down version of the Pod. Perfect for protecting your compact camera with its most important accessories. A drop-down front accessory "wing" features elasticized organizers for batteries and accessories. Carry this pouch either with the included removable shoulder strap, or attach it securely to your belt with the heavy duty metal spring clip. It is 7.25 x 5.5 x 5.5"; it's main compartment capacity is 6 x 4 x 3" (WHD) and weighs 9.6 oz. Available in Black (ROMPPB), Navy (ROMPPN), Yellow (ROMPPY), Red (ROMPPR), and Hunter (ROMPPH) .....**26.95**

**Small Pod Pouch:** When you want to carry the little essentials - a pocket-sized camera, batteries and other small accessories, this "micro bag" is for you. It comes with a shoulder strap and a super-tough belt-clip. 6 x 4.5 x 4.5" exterior; 5 x 3.5 x 2.5" main compartment capacity, it weighs 9.6 oz. Available in Black (ROSPPB), Titanium (ROSPPPT), Navy (ROSPPN), Yellow (ROSPPY), Red (ROSPPR), and Olive (ROSPPO).....**21.95**

**Podzilla:** The big brother of the original Pod is here, and it's hungry for your larger SLR camera (up to 8 x 8 x 4") and every cord, adapter, card and battery that goes with it. It features over 20 pockets, a fully padded main compartment with a one-piece, "segmented" divider panel, an outer pocket configuration that organizes accessories around the outside of the main compartment, elasticized accessory organizers, flap pockets, bungee keepers for cables or lens caps and more. Dual-height loops allow Podzilla to be worn as a waist pack on your own belt. A removable shoulder strap is also included. 9.25 x 9 x 6.5", it weighs 24 oz. Available in Black (ROPHCB), Navy (ROPHCBBL), Yellow (ROPHCBY), Red (ROPHCBR), and Hunter (ROPHCBH) colors .....**46.95**



### R.A.P.S.! Advanced Protection System

Versatile, inexpensive R.A.P.S. are an ideal way to add an extra measure of carrying protection, particularly inside luggage, carry-ons or other unpadded cases. Just wrap up anything you want to protect, pack it, and go! The Advanced Protection System offers a unique combination of "defensive" features: weather resistance, shock absorption, and - most notably - high-tech protection against environmental pollutants and corrosion. They feature 1/8" thick foam interlining and hook/loop closure material at all four corners which allow it to be folded, rolled and closed in virtually limitless configurations, to conform perfectly to any contents. They are available in four colors (Black, Grey, Yellow and Red) for instant identification of items inside a bag or case.

**R.A.P.S.! Large:** 20 x 20 x 0.2" (LWD); weighs 3 oz.....**17.95**

**R.A.P.S.! Medium:** 16 x 16 x 0.2" (LWD); weighs 2 oz.....**14.95**

**R.A.P.S.! Small:** 12 x 12 x 0.2" (LWD); weighs 1 oz.....**12.95**



**ONE HOUR FREE PARKING**  
AT 349 W. 34th STREET (with purchase of \$100 or more)

# ROADWIRED

## SHOULDER BAGS

BAGS

589



### MEGAMEDIA BAG

*With 36 – no, that's not a typo – compartments and pockets and an incredibly efficient layout, this mother of all tech bags lets you carry your computer, digital camera, MP3 Player, Palm Pilot, cellphone, discs, cables, adapters, papers, files, pens, and more... in one amazingly streamlined and manageable bag! If you're die-hard RoadWired, this is the one.*

- ◆ 36 pockets and compartments hold and organize a notebook computer, digital camera, MP3 player or minicassette recorder, Palm/PDA device, cellphone, CDs, PC cards, cables, adapters, papers, files, pens, business cards, and more!
- ◆ Intuitive layout provides “themed” subsections for equipment, media, paper and supplies, etc. Electronic equipment is organized towards the center of the case, for maximum balance and protection.
- ◆ Top-loading access to all contents is a lifesaver at airport security, or when working in tight quarters.
- ◆ Main compartment protected by shock-absorbing interlinings and double-padded floorboard. Adjustable padded divider panels allow for exact, “customized” fit.
- ◆ Removable ticket/passport organizer can be worn discretely on belt when traveling.
- ◆ Exclusive Hide and Go Home “secret pocket” hides, cash, key, etc.
- ◆ Contoured, 4-layer shoulder pad with moisture-wicking mesh and friction strip overlays. Stays put—with incredible comfort—when bag is heavily loaded (and this bag can get seriously loaded).
- ◆ Possibly the most comfortable carrying handle you've ever grabbed—just the right size, just the right rigidity, and just the right cushioning.
- ◆ Full-support webbing connects to shoulder strap and hand grip in a continuous loop supports bag securely and evenly—from the bottom to the sides... no “bag sag!”
- ◆ Smooth nylon panel on back of bag protects your clothing from wear-and-tear.
- ◆ Multiple clip-on points on both exterior sides for cellphone, accessory pouches, I.D. tags, etc. plus key clip, business card holder, divided see-through organizer pockets, magazine pocket, and more!
- ◆ Includes heavy-duty RoadWired luggage tag

**MegaMedia (ROMMCBB):** Measures 15.7 x 12.5 x 7.5” (LxHxD), weighs 5 lbs .....124.95

### DIGITAL DAYPACK

*Daypacks aren't just for books and snacks anymore—far from it. RoadWired's features an adjustable, padded laptop suspension system, expedition-quality shoulder harness and stowaway padded belt, mobile phone holster and much more (including plenty of room for books and snacks). One very cool and comfortable pack, yet sleek and elegant enough to carry into the office.*



- ◆ A dozen pockets and compartments hold and organize notebook computer, books and files, cables, media, accessories, documents, office supplies, more.
- ◆ Padded laptop suspension system adjusts to fit any notebook computer up to 15 x 11.5 x 2". System is supported directly by the shoulder harness through a polyethylene internal framesheet, and laptop is suspended above the separately-padded floor panel, for added protection when setting the pack down.
- ◆ Expedition-quality carrying harness features thickly padded and contoured straps with carry height adjustment. Adjustable sternum strap and padded, stowaway waist belt provide optimum comfort and weight distribution. Straps, belt and back panel are fully lined in moisture-wicking padded mesh.
- ◆ Separate, large accessory compartment features two zippered pockets, elasticized organizer for disks and pens, business card window pocket, and key clip. Additional exterior pocket for portable CD player and other small items.
- ◆ Angled “holster” on pack side allows instant access to mobile phone; positive side-release closure keeps it secure.
- ◆ Exclusive Hide and Go Home “secret pocket” hides emergency cash, key, etc.
- ◆ Compression straps on both sides allow adjustment to “snug up” the pack, keep contents from shifting, and keep weight as close to the wearer as possible.
- ◆ Thick, textured rubber exterior panel on pack bottom adds shock absorption, protects contents from wet or dirty surfaces, and won't scratch floors or desk tops when set down.

**Digital Daypack:** Measures 18 x 12 x 8” (LxHxD), weighs 3 lbs .....CALL

**ORDER & INFO. (212) 502-6340 • FAX: (212) 239-7770 (800) 947-7008  
1-800-290-6750 • www.bhphotovideo.com**



# ROADWIRED

## ROADSTER CONVERTIBLE

BAGS

590

Calling the Roadster Convertible a rolling briefcase is like calling the Batmobile a "car". The Roadster is a customizable carrier for all your tech-travel needs, with well over 2-dozen intelligently-designed compartments and pockets to protect and organize all your gadgets and accessories. At the heart of the case is the patent-pending RoadWired Transit (RTS) insert, which can be configured for laptop, portable projector or photo/video use, or even some of each.



- ◆ The RoadWired Transit System (RTS) insert sets up vertically or horizontally, and includes customizable padded dividers. You can also remove the RTS insert and use your Roadster as an overnight suitcase
- ◆ Four section, locking pull handle extends 40" and collapses into hideaway zipper compartment
- ◆ Removable, heavy-duty strap with 4-layer shoulder pad lets you comfortably carry the bag like a traditional business case
- ◆ Elasticized tie-down straps hold clothing in place while using the case in "luggage mode."
- ◆ Inline skate wheels roll smoothly, effortlessly and silently
- ◆ Lockable zipper pulls on main compartment for added security and deterrence
- ◆ Secret "Hide and Go Home" pocket
- ◆ Removable travel document pouch in front pocket features separate zippered compartments for ticket and passport
- ◆ Gusseted outer organizer sections feature multiple elasticized organizers and pockets for PDA, portable audio, compact camera, phone, CDs, and other media, cables, accessories, batteries, and more
- ◆ Multiple webbing "dock points" on the sides of the bag - a convenient place to clip optional phone or accessory pouches
- ◆ Protective skid plate protects Roadster from curb and stair edges

**Roadster Convertible:** Measures 17 x 13 x 9", weighs 9.5 lbs. The insert interior is 15¼ x 12¼ x 4" .....CALL

### Cable Stable

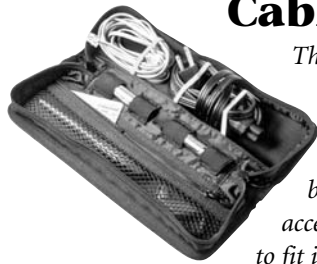

The slim Cable Stable organizes your AC power block and cord, modem cord, PCM-CIA cards, extra batteries and other small accessories. Efficiently designed to fit in the extra space alongside

your laptop in most full-size computer bags.

- ◆ Shock cord hold-downs provide fast, simple and versatile stowage for cords and adapters.
- ◆ Zippered mesh pocket holds smaller cords and items. Elastic loops provided for batteries, pens, laser pointer, PDA stylus.
- ◆ Soft spine and gusset panels allow it to conform to contents. Pack smaller, thinner items and the case takes up less space; pack more or bigger accessories, and the case accommodates. When empty, it can be compressed to store in a flat pocket!

**Standard Cable Stable Organizer (ROSCSB):**  
6+ pockets, 10 x 3 x 1.7" (WxHxD), 0.4 lbs.....**21.95**

**Deluxe Cable Stable Organizer (ROSCSB):**  
12+ pockets, 10 x 8 x 2" (WxHxD), 0.8 lbs.....**34.95**

**Deluxe Cable Stable Organizer Leather Edition:**  
Same as above, but crafted entirely in luxurious leather ....**44.95**

### KeyCard Travelock Security System



The Travelock Security kit uses mechanically-encoded cards in place of tiny, easily-lost metal keys or easily-forgotten numeric combinations. An interchangeable component system, the Travelock can be

configured to lock laptop, luggage, business case, photo bag or other valuables with just one lock. Includes all necessary attachments and accessories including:

- ◆ Long braided steel cable for securing laptop to desk, carry-on bag to cart, skis or other sports equipment, and more
- ◆ Short braided steel cable for lockable luggage zippers, gym or school lockers
- ◆ Metal locking attachment for laptop—fits into standard locking slot found on most current portable computers, and secures with long cable.
- ◆ 2 key cards—one for wallet or purse, and one mini version for keychain

"KeyCard" Travelock: Black .....**15.95**

"KeyCard" Travelock: Nickel .....**15.95**



**EQUIPMENT LEASING AVAILABLE**

# TAMRAC

## PROFESSIONAL LENS CASES

Featuring Dual Foam Technology, these black lens cases combine maximum shock protection closed-cell foam with open-cell foam for vibration dampening and a custom fit. A hard plastic bottom beneath the foam protects the lens from shock. These cases have full coverage rain flaps, double slider coil zippers, a handle on top, belt loops and "D" rings for accessory shoulder straps.



### Small Lens Case (TA342)

For lenses up to 5 1/4" long. Its dimensions are 5 1/4 x 7 1/4, it weighs 8 oz.....**29.50**

### Medium Lens Case (TA344)

For lenses up to 7 1/4" long. Its dimensions are 6 1/4 x 9, it weighs 9 oz.....**32.50**

### Large Lens Case (TA346)

For lenses up to 9 1/4" long. Its dimensions are 6 x 11 1/4, it weighs 12 oz.....**38.50**

## POINT & SHOOT POUCHES

**T4:** For ultra-compact cameras. Available in Black (TA5204B), Blue (TA5204BL), Green (TA5204GR), Chili (TA5204CH) and Steel Gray (TA5204G). Dimensions are 3 1/4 x 1 1/2 x 4".....**5.50**

**T6:** Specifically designed for ultra-compact cameras. Available in Black (TA5206B), Blue (TA5206BL), Green (TA5206GR), Chili (TA5206CH) and Steel Gray (TA5206G). 2 1/4 x 1 1/2 x 4 1/4". Weighs 1 oz.....**7.95**

**T8:** For compact cameras. 3 1/2 x 2 x 5 1/2". Available in Black (TA5208B), Blue (TA5208BL), Green (TA5208GR), Chili (TA5208CH) and Steel Gray (TA5208G).....**8.95**

**T14:** For ultra-compact cameras. Available in Black (TA5220B), Blue (TA5220BL), Green (TA5220GR), Chili (TA5220CH) and Steel Gray (TA5220G). Dimensions are 3 1/2 x 2 1/2 x 5". It weighs 4 oz.....**10.95**



**T17:** For slim cameras. Available in Black (TA5217B), Blue (TA5217BL), Green (TA5217GR), Chili (TA5217CH) and Steel Gray (TA5217G). Dimensions are 3 1/4 x 2 1/4 x 5 1/2". It weighs 4 oz.....**9.95**

**T18:** Perfect for compact cameras. 3 3/4 x 2 1/4 x 6 1/4". It weighs 4.2 oz. Available in Black (TA5218B), Blue (TA5218BL), Green (TA5218GR), Chili (TA5218CH) and Steel Gray (TA5218G).....**12.95**

**T20:** Protects cameras, personal stereos and other items. A zippered front pocket has a fitted pocket for memory cards or batteries. Adjustable shoulder strap and belt loop. Available in Black (TA5220B), Blue (TA5220BL), Green (TA5220GR), Chili (TA5220CH) and Steel Gray (TA5220G). 4 1/4 x 3 3/8 x 7 1/4". It weighs 5.5 oz.....**13.95**

## EXPO SERIES

Expo camera bags are perfect for the photographer who is not carrying a lot of equipment. Though compact in size, they are made with the same quality, workmanship and materials as Tamrac's larger bags.

**Expo Jr.:** Designed to carry compact cameras and small binoculars. It is also a great "extra pocket" for light meters, lenses and other accessories. It features a Speed Flap Top, a Windowpane-Mesh filter/lens cap pocket in the top, a front accessory pocket with zipper, and smooth nylon pack cloth on the back. It has an adjustable shoulder strap, a carrying handle, and belt loops to convert to a belt bag. 5 1/4 x 5 1/2 x 6 1/2". It weighs 7 oz. Available in Black (TA600B), Navy (TA600N), Gray (TA600G), Teal (TA600TE), Rust (TA600R) and Forest Green (TA600GR).....**31.50**

**Expo 1:** Ideal for a compact SLR and an extra lens or flash. It has an adjustable, foam-padded divider, a Windowpane-Mesh pocket, a zippered front pocket and smooth nylon pack cloth on the back. It features an EasyGrip carrying handle, an adjustable shoulder strap and belt loops for use as a belt bag. Available in Black (TA601B), Navy (TA601N), Gray (TA601G), Chili (TA601C), Teal (TA601TE), Purple (TA601P), Rust (TA601R) and Forest Green (TA601GR). 8 1/4 x 4 3/4 x 6 1/2", and it weighs 11 oz.....**35.95**

**Expo 2:** Similar to the Expo 1, but slightly larger. Two adjustable inner dividers allow you to carry a camera, extra lens, flash and accessories. 9 1/4 x 7 3/4 x 6 1/2", it weighs 12 oz. Available in Black (TA602B), Navy (TA602N), Gray (TA602G), Chili (TA602C) and Forest Green (TA602GR).....**42.50**



BAGS

591

ORDER & INFO. (212) 502-6340 • FAX: (212) 239-7770 (800) 947-7008  
1-800-290-6750 • www.bhphotovideo.com



# TAMRAC

## BACKPACKS

BAGS

592



TA759B  
\$241.95

### 759: PHOTO/COMPUTER BACKPACK

Nowadays, many photographers need to carry camera gear along with a notebook computer which is often a heavy load. This backpack was designed to comfortably carry a heavy load by spreading the weight across your back and shoulders while protecting the photography gear and the computer in separate, foam-padded compartments.

The main compartment will hold a full range of cameras, lenses and related gear including a pro-sized digital or film SLR with an attached lens up to 11" long.

Adjustable, foam-padded dividers allow customization to exactly match your mix of cameras, lenses and equipment. Windowpane-Mesh pockets on the front panel inside the main compartment hold filters and other small accessories visible and within easy reach.

- ◆ In back, a foam-padded compartment holds a laptop such as an Apple's 15" PowerBook G4 or others up to 14 x 11 x 2".
- ◆ Thickly padded harness straps have "D" ring attachments to add optional accessory camera straps
- ◆ The front panel of the pack unzips to reveal a set of organizer pockets designed to hold CDs, memory cards, floppy disks, cables, cords, and other computer-related accessories.
- ◆ Compatible with Tamrac's M.A.S. and S.A.S. systems
- ◆ Giant Rain Flaps protect all of the major compartments
- ◆ Dimensions: 12½ x 10¼ x 15½"; weighs 5 lb. 5 oz.



### EXTREME SERIES BACKPACKS

Tamrac's Extreme Series Photo Backpacks are expedition-level photo backpacks constructed of the strongest, lightest and most versatile high-performance materials available, some developed exclusively for Tamrac. Each pack has lightweight nylon lining, adjustable dividers and thick closed-cell foam.

#### 787 - Extreme Super Photo Backpack

The Extreme Super Photo Backpack is a full-sized, expedition-level photo backpack that is designed to carry a maximum amount of digital and photo equipment. The main compartment is filled with adjustable, foam-padded dividers that will hold the widest range of lenses and equipment. Windowpane-Mesh pockets on the inside of the front panel are perfect for filters and small accessories. The harness straps and hip belt are contoured and thickly foam padded. Additional features include: M.A.S. and S.A.S. attachment slots, QuickClip tripod attachment system, LockDown Rain Flaps, plastic platform in bottom, adjustable sternum strap, large front pocket, outer mesh pocket and lash tabs on the pack. Available in Black (TA787B) and Forest Green (TA787GR). External dimensions are 12 x 11¼ x 22½" (WxDxH). It weighs 7 lbs. 8 oz. ....339.95

#### 777 Summit Photo Backpack

Accommodates a combination of two 35mm or digital SLR cameras (one with a long lens attached), a lot of lenses and equipment. 12 x 11½ x 17¼" (WxDxH). Available in Black (TA777B) and Forest Green (TA777GR) colors. Weighs 6 lbs. 11 oz .....306.95



#### 767 Photo Trail Backpack

This compact backpack will hold cameras with attached lenses up to 11" long, making it excellent for everyday multi-purpose use. 12 x 10¼ x 15½" (WxDxH). Available in Black (TA767B) and Forest Green (TA767GR) colors. Weighs 5 lbs. 4 oz .....234.95



For Any Inquiries Regarding Your Order, Call Our Customer Service:  
(800) 221-5743 • (212) 239-7765 • FAX: (800) 947-2215 • (212) 239-7549

# TAMRAC

## DAYPACKS AND PRO SYSTEMS

### PHOTO DAYPACKS

For ultimate security and convenience, Tamrac developed a series of fully functional camera bags that do not look anything like camera bags. They look and function like daypacks, yet the lower half is a completely foam-padded and compartmentalized camera bag.

#### 752 - Super Photo Daypack

Professional-sized daypack with a foam-padded, contoured harness system. The discreet lower compartment is completely foam-padded, and holds two cameras bodies, 4-5 lenses and lots of accessories in the exclusive Lens-Bridge with LensGate divider system. Tripod straps and attachment slots for Tamrac's S.A.S. products. Available in Black (TA752B) and Forest Green (TA752GR) colors. 17 x 9 1/4 x 16 1/2", it weighs 3 lb. 10 oz.....**163.50**

**750 - Photographer's Daypack:** Accepts one camera with an attached lens and a motor drive. Dimensions are 17 1/2 x 9 1/2 x 14 1/2". Available in Black (TA750B) and Forest Green (TA750GR). Weighs 2 lbs. 10 oz.....**136.95**



BAGS

### PRO SYSTEMS

Pro Systems bags are designed to carry two SLRs with lenses attached, numerous other lenses and accessories. They're loaded with features like Tamrac's patented Lens-Bridge divider system, adjustable foam-padded dividers, ZipDrop paraphernalia and mesh pockets, end pockets and the unique Piggy-Back Pocket for slipping the bag over the handle of rolling luggage. For the ultimate in protection, the Pro Systems bags are made with real Dupont Cordura, and have thick, closed-cell foam padding, plastic platforms in the bottom, 5000 lb.-test shoulder straps and heavy duty, welded "D" rings.

#### 612 - Pro System 12

The perfect bag for the mobile photographer. It accepts two SLRs, 6-8 lenses and a flash. It features a total coverage top, adjustable foam-padded compartments, the exclusive Lens-Bridge divider system, Pop-Off film pockets, Piggy-Back Pocket, S.A.S. attachment slots and tripod straps. In front are two ZipDrop pockets, each with an internal zippered mesh accessory pocket; one can hold an optional ToolPak or FilterPak and the other has a paraphernalia pocket. EasyGrip carrying handle and torsion bar stabilizer strut in top. Available in Black (TA612B) and Gray (TA612G). 21 x 11 x 9 1/2"; it weighs 5 lbs. 5 oz .....**208.95**

#### 610 - Pro System 10:

An excellent general purpose bag for the working photographer. Accepts two SLRs, five to six lenses and a flash. It's dimensions are 20 x 11 x 10 1/2" and it weighs 4 lbs. 2 oz. It is available in Black (TA610B) and Gray (TA610G) .....**176.50**

#### 608 - Pro System 8:

A favorite of photojournalists because of its compact size. It accepts two SLRs, four to five lenses and a flash. It's dimensions are 17 1/4 x 9 x 8 1/4" and it weighs 3 lbs. 5 oz. It is available in Black (TA608B), Navy (TA608N) and Gray (TA608G).....**143.50**

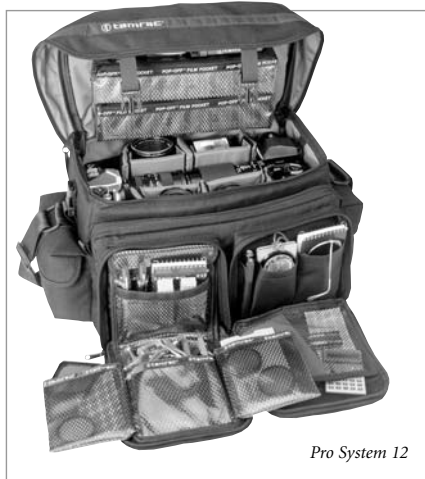

Pro System 12

593

### MEDIUM FORMAT PRO SYSTEMS

#### 622 - Medium Format Camera Bag (TA622B)

This bag is much easier to carry and work from than a hard case. A unique, scooped divider system allows large "potato masher"- type strobes or tele-lenses to be carried inside the bag without displacing other equipment. Internal dividers adjust to fit any Medium Format camera and accessories. There are two foam-padded end pockets, a full-length, foam-padded front pocket and two front ZipDrop pockets, each with a zippered internal mesh accessory pocket. 20 1/2 x 11 1/2 x 9 1/2"; it weighs 4 lbs. 4 oz .....**195.95**



ORDER & INFO. (212) 502-6340 • FAX: (212) 239-7770 (800) 947-7008  
**1-800-290-6750 • www.bhphotovideo.com**



# TAMRAC

## SUPER PRO'S AND ZOOM TRAVELER SERIES



### SUPER PRO'S

With the addition of power winders and grips, the bodies of many professional digital cameras and 35mm SLRs are very large. At the same time, large lenses have become more popular. Super Pros accommodate these cameras, multiple large lenses (with shades) and flashes. And with exception of the the 617, all Super Pros will even accept a notebook computer! Their features include a patented Lens-Bridge Divider System, ZipDrop pockets, total coverage tops, Pop-Off film pockets and much more!

*\*with exception of Model 617*

BAGS

594

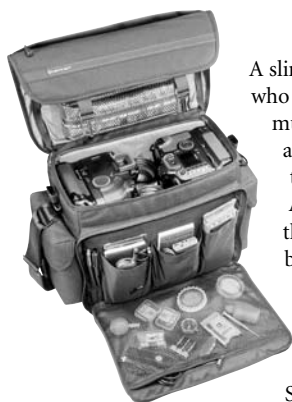

#### 619 - Super Pro 19 (TA619B)

A slim, briefcase-style bag for photographers who carry two large SLRs or digital cameras, multiple large lenses (with shades), and accessories. Foam-padded rear pocket protects other accessories or a laptop like an Apple PowerBook. Inside this pocket are three elastic compartments to hold extra batteries, chargers, adapters, etc. Features include total coverage top, Pop-Off film pocket, elastic accessory loops, a front flap pocket, two large end pockets, two rear ticket pockets, Strap Accessory

System attachment slots, tripod straps, Piggy-Back Pocket and EasyGrip handle. In front is a ZipDrop pocket with two internal zippered mesh accessory pockets and internal paraphernalia pockets. If your work requires lots of photo gear and a notebook computer, the 619 is your ultimate bag. Available in Black. 19 x 10 x 12½" (WxDxH); it weighs 4 lbs. 14 oz.....**248.50**

#### 617 - Super Pro 17 (TA617B)

Accepts two pro-sized bodies fully packed, 2 large lenses (most 200mm lenses and shades), a flash, and accessories. 13 x 8¼ x 11½" (WxDxH). Weighs 3 lbs. 6 oz.....**176.50**



#### 614 - Super Pro 14

Tamrac's largest Lens-Bridge camera bag for carrying the widest range of pro and digital SLR cameras, multiple large lenses and accessories. Foam-padded rear pocket protects accessories or even a thin notebook computer. Features a total coverage top, adjustable foam-padded compartments, Tamrac's Lens-Bridge divider system, Pop-Off film pockets, Piggy-Back Pocket, S.A.S. attachment slots, Speed Pocket on front

flap, foam-padded end pockets and tripod straps. In front are two ZipDrop pockets, each with an internal zippered mesh accessory pocket. EasyGrip carrying handle and torsion bar stabilizer strut in top. The solution for photographers who need a full complement of photographic equipment. Available in Black (TA614B) and Gray (TA614G). 24 x 14 x 11½"; it weighs 7 lbs. 3 oz .....**294.50**

#### 613 - Super Pro 13

For those with a full complement of pro and digital SLR cameras, multiple large lenses and accessories. Available in Black (TA613B) and Gray (TA613G). 21 x 13 x 11", it weighs 5 lbs. 14 oz.....**248.50**

### ZOOM TRAVELER SERIES

The Zoom Travelers are tough, compact and lightweight and have many of the features of Tamrac's professional-sized camera bags. Over the last twenty years, these products have become the benchmark for camera carrying systems and have to be among the most popular camera bags in the world. They are ideal for a single SLR with several lenses and accessories.

#### 606 - Zoom Traveler 6

The Zoom Traveler 6 is designed for an SLR, 3 to 4 lenses and a flash. Features include the USA patented Lens-Bridge and LensGate Divider System, two large Velcro closing end pockets, Pop-Off film pocket, a full-length ZipDrop front pocket with organizer compartments, the Slide Pocket with ID tag in front for film and filters, a unique Piggy-Back Pocket for travel with rolling luggage and tripod straps to hold a small tripod or a light jacket. This is the most full-featured camera bag and perfect for the photographer working with a single camera. Available in Black (TA606B), Gray (TA606G), and Navy (TA606N) colors. Dimensions are 15¼ x 10 x 8½"; it weighs 2 lbs. 7 oz.....**117.50**

**604 - Zoom Traveler 4:** Accommodates an SLR camera, 3 to 4 lenses and a flash. 2 lbs. 2 oz; 12 x 10 x 8¼". Black (TA604B), Gray (TA604G), Navy (TA604N) and Forest Green (TA604GR) colors...**97.95**

**Model 603 - Zoom Traveler 3:** Holds an SLR camera, 2 or 3 lenses and a flash. 10¼ x 9¼ x 7¼"; 1 lb. 15 oz. Black (TA603B), Gray (TA603G), Navy (TA603N) and Forest Green (TA603GR) colors...**78.50**



EQUIPMENT LEASING AVAILABLE



# TAMRAC

## HOLSTER PACKS, VESTS & TRIPOD CASES

### H O L S T E R   P A C K S



**519 Pro Zoom Pak (TA519B):** The perfect bag if you want the absolute minimum in a camera bag and still have excellent protection. It allows the camera to be carried with minimal bulk and fuss, and can accommodate large pro cameras such as Nikon F5 and Canon's EOS cameras together with an attached zoom lens up to 8" long. Inside the top is a Windowpane-Mesh pocket for filters, lens caps or cleaning materials. A large outside pocket holds a flash and accessories. The Pro Zoom Pak accepts Modular Accessory System accessories and fits onto Tamrac's M.A.S. belt system. Available in Black. 9½ x 6½ x 10½" (WxDxH), it weighs 11 lbs. 2 oz.....**52.50**

**517 Tele-Zoom Pak:** This Zoom Pak accepts a 35mm SLR camera with an attached lens up to 7½" long. An internal, padded divider provides protection for extra lenses or accessories. A large outside pocket will hold a flash, extra film and accessories. Available in Black (TA517B), Gray (TA517G), Navy (TA517N) and Forest Green (TA517GR). 9¾ x 5¼ x 10½, it weighs 13 oz. ....**38.95**

**515 Compact Zoom Pak:** Holds most 35mm SLR cameras with an attached lens up to 5½" long. A large zippered front pocket holds a small flash, extra film and accessories. Wear it as a chest pack with the optional Chest Harness. Available in Black (TA515B), Gray (TA515G), Navy (TA515N), Chili (TA515CQ) and Forest Green (TA515GR). 7¼ x 5¼ x 8½", it weighs 11 oz.....**32.50**

**514 Sub-Compact Zoom Pak:** Designed to hold a compact SLR camera with a lens up to 3" long attached. A pocket inside the top holds items like filters, memory cards, lens caps, etc. An outside zippered pocket will hold extra film and accessories. Available in Black (TA514B), Gray (TA514G), Navy (TA514N), Chili (TA514CQ) and Forest Green (TA514GR). 6¼ x 5¾ x 7¼", it weighs 10 oz.....**29.95**

**BAGS**

**595**

### Model 153 - World Correspondent's Vest

The World Correspondent's Vest is both a functional tool and a good looking addition to any photographer's wardrobe. Constructed of 100% cotton with nylon mesh vents, it has excellent yet discreet ventilation and lots of convenient pockets. The front of the vest features 10 pockets. During hot weather, two zipper-vented mesh pockets open to provide cooling ventilation. Two zippered side pockets give you secure space for film and accessories. Discreet vented back panels provide flow-through ventilation without looking like a mesh vest. Side tabs are provided so the vest can be adjusted for a custom fit. The front zips open and closed with a two-way zipper and snap tab allowing the vest to be adjusted for perfect ventilation and comfort. Four "D" rings provide safe accessory and press pass attachment points and snap-down epaulets keep camera and bag straps from slipping off the shoulder. Washable with less than 5% shrinkage.



|   |  |  |  |  |
|---|--|--|--|--|
| <b>Small Vest</b><br>Available in<br>Black (TA153SB) and<br>Khaki (TA153SK) .... <b>95.95</b> | <b>Medium Vest:</b><br>Available in<br>Black (TA153MB) and<br>Khaki (TA153MK) ... <b>95.95</b> | <b>Large Vest:</b><br>Available in<br>Black (TA153LB) and<br>Khaki (TA153LK) .... <b>95.95</b> | <b>Extra Large Vest:</b><br>Available in<br>Black (TA153XLB) and<br>Khaki (TA153XLK) .. <b>95.95</b> | <b>XX-Large Vest:</b><br>Available in Black<br>(TA153XXLB) and Khaki<br>(TA153XXLK) ..... <b>95.95</b> |
|---|--|--|--|--|

### T R I P O D   C A S E S



**Medium Tripod Bag (TA324B)**  
For tripods up to 25" when folded. Zippered exterior pocket for cable releases and accessories. Black waterproof PowerGrid Cordura. 9 x 27½", it weighs 14 oz.....**29.50**

**Large Tripod Bag (TA326B)**  
Same as above, for tripods up to 33" folded. 10¼ x 35", it weighs 1 lb. 1 oz.....**35.95**

**Extra Large Tripod Bag (TA327B)**  
Same as above, for tripods up to 39" folded. 11¼ x 40½", it weighs 1 lb. 2 oz.....**38.50**

**Professional Location Bag (TA328B)**  
For professional light stands and tripods up to 46", Foam padded with internal Cordura pockets. Its dimensions are 9 x 8 x 47", and it weighs 3 lbs. 12 oz.....**97.95**

**Padded Tripod Bag (TA332)**  
For professional tripods up to 37" long when folded. Zippered interior pocket for cable releases and other accessories. Fully foam padded with closed-cell foam. Made of waterproofed PowerGrid Cordura. 9½ x 2½ x 38", it weighs 2 lbs.....**71.95**

**ORDER & INFO. (212) 502-6340 • FAX: (212) 239-7770 (800) 947-7008  
1-800-290-6750 • www.bhphotovideo.com**



# TAMRAC

## 5000 SERIES

### EXPEDITION SERIES BACKPACKS

BAGS

596

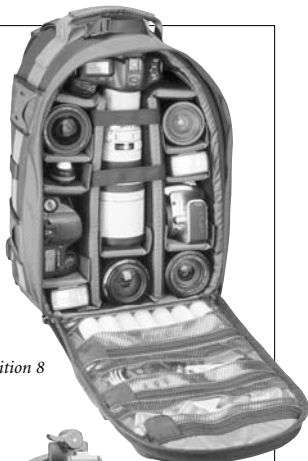

Expedition 8



Expedition 7



Expedition 5



Expedition 4



Expedition 3

Tamrac has completely redesigned its popular Expedition Series backpacks to set a new standard of quality, function and comfort for photographic backpacks. Besides their striking design, some unique highlights of the new backpacks include the Dual “wing” accessory pockets with water-resistant zippers that organize and provide quick access to important accessories without disturbing other gear. The patented Memory & Battery Management System uses red flags to identify available memory cards and batteries. Dual-Density Comfort Pads on the back provide maximum carrying comfort and Air Flow Channels help to keep you cool and dry. The QuickClip tripod attachment system securely holds a tripod centered and balanced between the “wing” accessory pockets while the lower plastic-reinforced Tripod Foot Pocket holds two tripod legs secure.

**Expedition 8 (TA5578)**  
The Expedition 8 is Tamrac’s largest backpack for carrying the most extensive collection of photo equipment. The main compartment has numerous adjustable, foam-padded dividers to protect multiple pro-size SLRs, a full range of lenses, and flashes. A BioCurve dual pivoting waist belt and contoured harness provide a custom fit and distribute the weight of the pack evenly. It also features Windowpane-Mesh pockets, water-resistant zippers, and MAS and SAS attachment slots. It’s dimensions are 13 x 13½ x 22” and it weighs 7 lb. 4 oz .....**199.95**

**Expedition 7 (TA5577)**  
This full-featured backpack holds a wide range of SLRs, lenses, and accessories. It’s dimensions are 13 x 13½ x 19½”, and it weighs 5.8 lbs .....**179.95**

**Expedition 5 (TA5575)**  
A medium-sized backpack with foam-padded protection for multiple SLRs, 5-6 lenses and accessories. 12½ x 10 x 16”. Weighs 4.3 lbs.....**129.95**

**Expedition 4 (TA5574)**  
A feature rich, compact pack that holds an SLR, 3-4 lenses (including a 200mm zoom), and accessories. 12 x 9½ x 14”. Weighs 3.8 lbs.....**109.95**



“Wing” accessory pockets feature Tamrac’s Memory and Battery Management System



The Expedition 8 and 7 both feature a Rear Harness System. This consists of a BioCurve dual pivoting waist belt and contoured harness to provide a custom fit and distribute the weight of the pack evenly



Front accessory pocket features Tamrac’s Memory and Battery Management System

**Expedition 3 (TA5273)**  
The Expedition 3 offers expedition-level performance in a compact photo backpack. This full-featured pack holds most SLRs with a lens attached up to 7” long, 2-3 lenses and accessories. 9 x 6¼ x 13¼”. Weighs 1 lb. 7 oz.....**44.95**



# TAMRAC

## 5000 SERIES

### PHOTO / DIGITAL COMPUTER BACKPACKS

Combine your laptop, SLR equipment, and accessories in a convenient, easy-to-carry backpack. CyberPacks are completely padded with thick, closed-cell foam and have foam-padded plastic platforms in the bottom for shock protection. Inside the main compartment, adjustable dividers can be customized to fit cameras, lenses and other accessories. A separate and completely foam-padded compartment provides quick access to a laptop without disturbing photo gear. You can add Modular and Strap Accessory System components to customize these packs.

#### CyberPack 9

**Photo/Computer Backpack (TA5259B)**  
Perfect for the imaging professional carrying a laptop and a pro-sized SLR with an attached 200mm zoom lens, several additional lenses and an extra camera body. A foam-padded rear compartment accommodates laptops up to 12¼ x 10½ x 2". The CyberPack has a zippered pocket under the front flap, an open pocket for files or tickets, and a large zippered accessory pocket. A cinch strap keeps your camera in place and a large LockDown rain flap protects the main compartment zippers. Two Windowpane-Mesh pockets organize accessories and filters for easy access. Black color. 13 x 9½ x 16¼", it weighs 5 lb. 4 oz.....**179.95**

#### CyberPack 8 Photo/Computer Backpack (TA5258B)

Ideal for the pro traveling with a ton of gear. The main compartment accepts multiple camera bodies, a long telephoto lens up to 13½" attached to an SLR, an array of additional lenses, strobes, and a large laptop up to 11 x 2 x 15½". A professional tripod can be securely carried using the QuickClip tripod attachment system. A padded shoulder harness, padded hip belt, and sternum strap ease the burden of carrying this well equipped pack. Available in Black. 13½ x 11¼ x 20"; weighs 7 lb. 7 oz.....**175.00**

#### CyberPack 6 Photo/Computer Backpack (TA5256B)

Similar, yet more compact than the CyberPack 8, the CyberPack 6 can accommodate 2 pro-sized SLR cameras, many lenses including a f/2.8 200mm zoom lens and a couple of strobes. Laptops up to 11 x 2 x 14" are protected in a separate, foam-padded compartment. 13½ x 10¼ x 17"; weighs 5 lb. 13 oz.....**129.95**

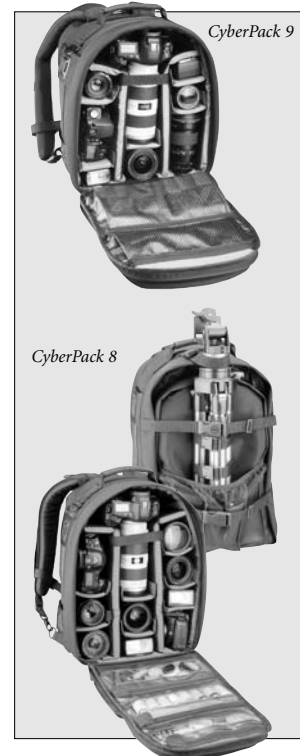

BAGS

597

### VELOCITY SERIES

The Velocity Series combines contemporary styling with innovative design features. Though they look like upscale travel bags, they have exclusive camera bag features to assure quick access, ease of use and excellent protection.



**Velocity 9 Pro Sling Pack:** The Velocity 9 can be carried like a backpack, but can be swung around to the front to provide quick access to a pro-sized 35mm with an attached 200mm zoom lens. It has a well-padded sling strap, a large exterior pocket and internal organizer pockets. You can customize this pack with M.A.S. accessories. Available in Black (TA5749B) and Blue (TA5749BL) colors. Its dimensions are 13 x 6½ x 15"; it weighs 1 lb. 14 oz.....**57.95**

**Velocity 7 Photo Sling Pack:** Holds an SLR up to 4¾" tall with a 6" lens attached. 11½ x 5¼ x 12"; it weighs 1 lb. 4 oz. Available in Black (TA5747B) and Blue (TA5747BL) colors.....**45.50**

**Velocity 6 Compact Sling Pack**  
Holds a compact SLR with a 4" zoom lens attached and accessories. 9½ x 5 x 9½"; it weighs 14 oz. Available in Black (TA5746B) and Blue (TA5746BL) colors .....**29.95**

**Velocity 4 Micro Sling Pack (5744)**  
Tamrac's smallest sling pack holds a digital camera and accessories. 7 x 4½ x 8"; it weighs 10 oz. Available in Black (TA5744B) and Blue (TA5744BL) colors .....**22.50**



**Velocity 5 Photo Hip Pack Convertible:** This high performance and versatile hip pack holds and protects an SLR with a zoom lens attached, additional lenses and a flash. Available in Black (TA5745B) and Blue (TA5745BL). Dimensions are 11½ x 6½ x 9"; and it weighs 1 lb. 11 oz.....**45.50**

**Velocity 3 Messenger Camera Bag:**  
Slim profile bag for an SLR and several lenses. Available in Black (TA5743B) and Blue (TA5743BL). 13¼ x 5½ x 9½"; it weighs 1 lb. 8 oz .....**38.95**

**Velocity 2 Compact Messenger Camera Bag:**  
Compact version of the Velocity 3. Available in Black (TA5742B) and Blue (TA5742BL). Dimensions are 9¼ x 5¼ x 9¼"; it weighs 1 lb. 3 oz .....**32.50**

ORDER & INFO. (212) 502-6340 • FAX: (212) 239-7770 (800) 947-7008  
**1-800-290-6750 • www.bhphotovideo.com**



# TAMRAC

## 5000 SERIES

BAGS

598



### PRO SERIES

*Designed for today's active photographers, Pro Series bags are lightweight, extremely durable and provide excellent protection for photographic equipment. They adjust to fit and protect a wide variety of photographic equipment.*

**Pro 12 (TA5612):** The Pro 12 holds two cameras with attached lenses, many more lenses and accessories. The foam-padded interior features the patented Lens-Bridge divider system. ZipDrop front pockets have organizer pockets and a zippered mesh accessory pocket. Additional features include Dual Action Top, Windowpane-Mesh pocket inside the top, Slide Pocket with Memory & Battery Management System, large side pockets, a zippered back pocket, a strong plastic platform in bottom, tripod straps, EasyGrip handle, and adjustable, padded BioCurve shoulder strap. Available in Black. 20 x 10 1/4 x 9 3/4"; it weighs 3 lbs. 6 oz .....**109.95**

**Pro 8 (TA5608BL):** A pro-sized bag that carries two cameras with their attached lenses. Dimensions are 17 x 10 x 8 1/2", and it weighs 2 lbs. 11 oz. Available in Black (TA5608B) and Blue .....**84.95**

**Pro 5 (TA5605B):** A compact bag that accommodates the largest SLR with a 200mm lens attached. Dimensions are 11 1/4 x 8 x 12"; it weighs 2 lbs. 5 oz. Available in Black .....**58.50**

### SYSTEM SERIES

**System 6:** The System 6 holds a digital or film SLR with an attached zoom lens in Tamrac's USA patented Lens-Bridge and LensGate Divider Systems, 3 to 4 extra lenses and a flash. Features include: Dual Action Top, completely foam-padded adjustable dividers, Slide Pocket featuring Tamrac's exclusive Memory & Battery Management System (patent pending) for identifying available memory cards and batteries, ZipDrop front pocket for accessories, side pockets for extra storage, zippered back pocket for important papers, EasyGrip carrying handle, Piggy-Back Pocket, BioCurve shoulder strap with a non-slip patch, and tripod straps. Compatible with Tamrac's Strap Accessory System (S.A.S.) for complete customization. Available in Black (TA5606B) and Blue (TA5606BL). 16 x 8 1/4 x 7 1/2"; it weighs 2 lbs.....**59.95**

**System 3:** Perfect for photographers with an SLR, two or three lenses and a few accessories. It's dimensions are 10 1/2 x 9 1/4 x 8", and it weighs 1 lb. 8 oz. It is available in Black (TA5603B) and Blue (TA5603BL) colors .....**47.50**

**System 2:** An excellent, compact bag for a photographer with a couple lenses and a small flash. It's dimensions are 10 x 8 x 6 1/2", and it weighs 1 lb. 4 oz. It is available in Black (TA5602B) and Blue (TA5602BL) colors .....**35.95**



### EXPLORERS

*The Explorers are slim profile camera bags with digitally oriented features to accommodate digital and film SLRs and accessories. All feature Dual Foam Technology that combines closed-cell foam to provide maximum shock protection with open-cell foam for vibration dampening and custom fit.*



Explorer 2

**Explorer 2:** A slim bag for cameras with attached lens up to 6" long, an extra lens, plus a flash and accessories. Features include a hidden Tuck-A-Way hip belt that converts it to a convenient hip pack, Total Coverage Top, a Slide Pocket with Memory & Battery Management System for identifying available memory cards and batteries, a pocket in the lid for lens cleaning paper, a ZipDrop front organizer pocket with mesh pocket, an EasyGrip carrying handle, and a foam-padded, BioCurve shoulder strap. S.A.S. and M.A.S. attachment slots allow complete customization. 9 1/2 x 7 1/4 x 9"; it weighs 1 lb. 12 oz. Available in Black (TA5202B) and Blue (TA5202BL) colors .....**38.95**

**Photo-Video 1:** Similar to the Explorer 2, but slightly smaller. Available in Black (TA5201B), Blue (TA5201BL) and Green (TA5201GR). Dimensions are 9 x 6 1/4 x 7 1/2"; it weighs 1 lb. 8 oz .....**32.50**

**Explorer 10:** Accepts a compact SLR with lens attached and a few accessories. Available in Black (TA5210B), Blue (TA5210BL) and Green (TA5210GR). 7 x 8 1/2 x 6"; it weighs 13.4 oz .....**32.50**

**Micro Explorer:** Perfect for a small 35mm camera or large digital camera. Available in Black (TA5200B), Blue (TA5200BL) and Green (TA5200GR). 6 1/4 x 4 1/4 x 6 1/4"; it weighs 9 oz .....**16.95**



# TAMRAC

## 5000 SERIES

### ADVENTURE DAYPACKS



◀ Adventure 8

Adventure 2 ▶

#### Adventure 8 (TA5248)

This medium-sized photo daypack has a foam-padded lower compartment for a camera and a full complement of lenses and accessories. It can easily hold and protect an SLR with attached lens up to 5" long, 3-4 lenses and a flash. A full-sized, non-padded compartment on top holds personal gear. Features include a padded shoulder harness with a quick-release sternum strap, an inner mesh accessory pocket, a zippered front organizer pocket, side pockets, a quick-access zippered flap pocket and tripod straps. Add optional accessories to the Strap Accessory System (S.A.S.) attachment slots to customize this pack. The Adventure 8 is available in Black. Dimensions are 12¼ x 7¼ x 13¾". It weighs 2 lbs. 2 oz. ....62.50

**Adventure 2:** This compact photo backpack is similar to the Adventure 8, but a bit smaller. It holds and protects an SLR with an attached lens up to 3" long, 1-2 lenses and a flash. Dimensions are 11 x 8¼ x 10½". It weighs 1 lb. 15 oz. Available in Black (TA5242B) and Forest Green (TA5242GR) colors .....49.95

BAGS

599

### CLASSIC CONVERTIBLES



*Convertible camera bags offer the broadest utility by changing from one type of carrying system to another, which offer multiple carrying options. Each converts from a shoulder bag to a hip pack.*

#### 709 - Pro Convertible (TA709B)

Ideal for photographers on the move with two SLR or digital cameras, four to five lenses and a flash. It's features include a Tuck-A-Way hip belt so it can quickly convert from a comfortable shoulder bag to a hip pack, total coverage top, adjustable foam-padded compartments, Lens-Bridge with LensGate divider system, LensHatch in back, Pop-Off film pocket, large padded end pockets, tripod straps, EasyGrip handle and torsion bar, S.A.S. attachment slots and a ZipDrop pocket with an internal zippered mesh accessory pocket and paraphernalia pockets for personal items and small accessories. Available in Black. 16½ x 10½ x 9½" (WDH); it weighs 3 lbs. 12 oz. ....182.95

**706 - Deluxe Convertible:** For a single camera with an attached lens up to 8", four to five lenses and a flash with the convenience of a hip belt. 15 x 10 x 9¼". Available in Black (TA706B) and Forest Green (TA706GR). Weighs 2 lbs. 3 oz. ....97.95

**704 - Sport Convertible:** For a single camera with an attached lens, two to three lenses and a flash with the convenience of a hip belt. 11 x 9 x 7¼". Available in Black (TA704B) and Forest Green (TA704GR). Weighs 1 lbs. 5 oz. ....68.50

PHOTO MESSENGER



#### 469 - Photo Messenger 9

The Photo Messenger 9 features a TurboTop for instant access to the foam-padded main compartment, which holds a pro-sized camera with an attached lens up to 7½" long, 4 to 5 lenses, a flash, and accessories. The foam-padded back pocket accommodates an Apple PowerBook or other large laptops up to 16 x 10½ x 3¼". Additional features include internal organizer pockets, a large Windowpane-Mesh pocket, open pleated pockets, a side mobile phone pocket, two zipper-closing pockets, and a Piggy-Back Pocket. Modular Accessory and Strap Accessory System attachment slots provide many storage options. Available in Black (TA469B). 18 x 7 x 13" (expanded adds 2" to depth), it weighs 3 lbs. 11 oz. ....176.50



# TAMRAC

## 5000 SERIES

### LIGHTWEIGHT PHOTO BACKPACKS

#### Travel Pack 71

Tamrac's most compact photo backpack, the Travel Pack 71 holds a compact SLR with an attached lens, a couple of additional lenses and accessories. The front zippered pocket has paraphernalia pockets and the Memory & Battery Management System, which uses red flags to identify fresh memory cards and batteries. Mesh pockets in the front, on the sides and inside the pack hold extra accessories. Other features include a padded backpack harness, and an EasyGrip handle. The Travel Pack 71 accepts optional to S.A.S. and M.A.S. accessories. Available in Black (TA5371B), Blue (TA5371BL) and Steel Gray (TA5371G). It's dimensions are 9 x 7¼ x 11½" and it weighs 1 lb. 7oz .....32.95



#### Adventure 75

This lightweight, high-mobility pack provides foam-padded protection and quick access to multiple SLRs, lenses, a flash and accessories. The interior lid of the main compartment features Tamrac's patented Memory & Battery Management System that uses red flags to identify available memory cards and batteries. Windowpane-Mesh pockets organize film, filters and other small accessories. The QuickClip tripod attachment system accommodates a tripod centered and balanced on the pack. An outer vinyl-reinforced mesh pocket and bungee cord tie downs provide quick access to other gear. A comfortable, foam-padded backpack harness and adjustable waist strap provide easy carrying comfort. Other features include LockDown Rain Flap for weather protection, a front pocket to hold a light jacket or accessories, and an EasyGrip carrying handle. The Adventure 75 can be fully customized using Tamrac's optional Modular Accessory System (M.A.S.) and Strap Accessory System (S.A.S.) products. It's dimensions are 12½ x 9 x 16", and it weighs 4 lb. 2 oz. Available in Black (TA5375B) and Forest Green (TA5375FG).....89.95



### ZOOM PACKS

Designed for SLRs with a lens attached. A front pocket holds film and features the Memory & Battery Management System that identifies available memory cards from ones that are used up. An EasyGrip carrying handle, shoulder strap, and belt loops provide convenient carrying options.

#### Travel Zoom 5

Holds an SLR with lens attached up to 4½" long. Side pockets hold accessories. 7 x 6¼ x 8". Available in Black (TA5315B), Steel Gray (TA5315G) and Blue (TA5315BL) colors. It weighs 13 oz.....22.50

#### Travel Zoom 4

Holds an SLR with a lens attached up to 3¾" long. Dimensions are 7 x 6¼ x 7". Available in Black (TA5314B), Steel Gray (TA5314G) and Blue (TA5314BL) colors. It weighs 11 oz.....19.95



Travel Zoom 5

HOLDS LAPTOPS

### CYBERPRO

#### Turbo CyberPro Photo/Computer Briefcase (TA5618B)

A slim, briefcase-style carrying system for your laptop and photo gear. The patented TurboTop opens with a quick pull of the parallel double zippers to provide instant access to your equipment. Inside, foam-padded dividers organize and protect your equipment in a vertical orientation for a slim profile. A separate, foam-padded pocket in back protects laptops up to 11 x 2 x 15½". Numerous interior and exterior pockets organize your accessories. An exclusive Slide Pocket with the Memory & Battery Management System helps to identify available memory cards and batteries from ones that are used up. Features include Modular Accessory and Strap Accessory System attachment slots, and a Piggy-Back Pocket to slip the bag over the handle of rolling luggage. 17½ x 8¼ x 12½". It weighs 3 lb. 13 oz.....98.95



**ONE HOUR FREE PARKING**  
AT 349 W. 34th STREET (with purchase of \$100 or more)

BAGS

600

# TAMRAC

## ROLLING CASES

BAGS

601

**HOLDS LAPTOPS**

### CYBERPROS / CYBERPACKS



**CyberPro Express (TA5263B):** The CyberPro Express holds two large SLRs, multiple large lenses (with shades) and a laptop. A foam -padded pocket holds large laptops up to 11 x 2 x 15 $\frac{1}{2}$ ". A large front accessory pocket organizes CDs, a PDA, pens, mobile phone and sunglasses. Large end pockets store bulky items. Smaller accessories can be stored in a pocket inside the top lid. A weather-protected Speed Pocket on the front flap keeps important accessories available for quick access. The telescoping handle opens and closes with the push of a button and stows away in a zippered pocket. Ball-bearing, in-line skate wheels ensure a smooth, stable ride. Its dimensions are 22 x 11 x 13 $\frac{1}{2}$ " and it weighs 8 lbs. 2 oz .....**249.95**

**CyberPro Flyer (TA5261B):** The CyberPro Flyer holds a large SLR, several large lenses (with shades) and a compact laptop. A foam -padded pocket holds a laptop up to 12 $\frac{1}{2}$  x 1 $\frac{1}{2}$  x 10". A front accessory pocket organizes personal items. A weather-protected Speed Pocket on the front flap keeps important accessories available for quick access. The telescoping handle opens and closes with the push of a button and stows away in a zippered pocket. Ball-bearing, in-line skate wheels ensure a smooth, stable ride. Its dimensions are 14 $\frac{1}{2}$  x 9 $\frac{1}{4}$  x 14 $\frac{1}{4}$ " and it weighs 7 lbs. 3 oz .....**CALL**

**CyberPack Express Photo/Computer Backpack (TA5265B):** With the versatility of wheels and a Tuck-A-Way backpack harness, the Rolling CyberPack is ideal for carrying a pro-sized SLR with a 200mm zoom lens attached, many additional lenses and accessories. A padded front pocket holds a laptop up to 11 x 2 x 13" in size. Internal Windowpane-Mesh pockets organize filters, film, and other small items. Features a QuickClip Tripod Attachment System, ball bearing in-line skate wheels, an industrial strength telescoping handle and M.A.S. attachment. Its dimensions are 14 x 13 x 19", and it weighs 10 lb. 3 oz .....**275.00**

### BIG WHEELS ROLLING STRONG BOXES

**HOLDS LAPTOPS**

Traveling with heavy camera equipment has never been easier. To keep you connected wherever your travels may take you, each Big Wheels Rolling StrongBox has a foam-padded front pocket for carrying a notebook computer, files or paperwork. These rolling cases offer even greater stability and mobility with 94mm wheels to help you negotiate cobblestone roads, uneven sidewalks, deep carpet or grass. The Ballistic nylon outer shell and rigid, plastic-armored walls combine with full foam padding inside to provide a very tough and versatile camera case.

**LP5 Big Wheels Rolling StrongBox (TA695B):** Designed for wedding and event photographers who carry their camera with a bracket and strobe attached. For shooting outdoors, the LP5 offers the ultimate in mobility with its large wheels, keeping the weight off the photographer and keeping your equipment well protected. This case has two zippered front pockets, one of which is foam padded for notebook computers up to 12 $\frac{3}{4}$  x 10 $\frac{1}{2}$  x 2". It features Modular Accessory System attachment slots and RollerProp compatibility. The LP5 is also excellent when used in conjunction with a camera bag equipped with a Piggy-Back Pocket. Dimensions are 14 $\frac{1}{2}$  x 12 $\frac{1}{2}$  x 30". It weighs 16 lbs 11 oz.....**385.50**

**LP4 Big Wheels Rolling StrongBox (TA694B)**  
For those who are not concerned with airline carry-on restrictions. It features 2 zippered front pockets. Dimensions are 16 x 13 x 30". It weighs 17 lbs. 11 oz.....**391.95**

**LP2 Big Wheels Rolling StrongBox (TA692B)**  
An all-purpose case that meets many airline carry-on restrictions. It features a multi-level storage system. Dimensions are 14 x 9 x 23 $\frac{3}{4}$ ". It weighs 13 lbs 4 oz.....**326.95**



**LP1 Big Wheels Rolling StrongBox (TA691B)**  
Meets the current, most stringent carry-on restrictions. accommodates SLRs, lenses, accessories and a laptop. Dimensions are 14 x 9 x 22 $\frac{1}{2}$ ". It weighs 11 lbs 10 oz.....**293.95**

**ORDER & INFO. (212) 502-6340 • FAX: (212) 239-7770 (800) 947-7008  
1-800-290-6750 • www.bhphotovideo.com**





# TAMRAC

## ROLLING CASES

BAGS

602



### BIG WHEELS ROLLING BACKPACKS

Tamrac's Big Wheels Rolling Photo Backpacks combine the convenience of a wheeled camera bag with the advantages of a photographer's backpack using a hidden Tuck-A-Way backpack harness. The front pocket of each is foam padded for accessories, files or a notebook computer. A QuickClip tripod attachment holds professional sized tripods.

#### Big Wheels Rolling Photo Backpack LP8 (TA698B)

High-capacity rolling photo backpack designed to hold numerous 35mm and digital SLRs, medium format cameras, large telephoto lenses and a multitude of related equipment. Completely foam padded dividers can be customized to create protective compartments to hold just about any size camera bodies, lenses, flashes and accessories. The front pocket is foam padded to hold a large laptop up to 15½ x 11½ x 2". The pack is compatible with Tamrac's M.A.S. and S.A.S. systems and has the QuickClip tripod attachment system that allows you to attach and protect your professional tripod. Dimensions are 13½ x 11 x 25¼". It weighs 12 lbs. 13 oz .....417.95

#### Big Wheels Rolling Photo Backpack LP7 (TA697B)

Carries a 35mm or digital SLRs with a large tele-photo lens attached and a very broad selection of equipment, including a laptop up to 14 x 10¼ x 2". Dimensions are 12¾ x 10¼ x 22¼". 11 lbs. 5 oz.....372.50

### ROLLING STRONGBOXES



Featuring ball bearing in-line skate wheels and an industrial-strength telescoping handle system, Rolling StrongBoxes have a Ballistic nylon outer shell, full foam padding inside, adjustable dividers, a lockable zipper, top and side leather-padded handles, and M.A.S. attachment slots. An optional RollerProp accessory allows you to work with the StrongBox propped at a safe 60° angle. Rolling StrongBoxes provide a new level of mobility.

#### Jumbo Rolling StrongBox (TA654B)

Accepts 2 SLRs, 8-10 large lenses and a handle-mount flash on wheels without sacrificing protection. It features two large front pockets, M.A.S. attachment slots, RollerProp and PiggyBack Pocket compatibility. 14½ x 12½ x 29", it weigh 16 lbs. 8 oz .....365.95

#### Rolling StrongBox (TA652B)

Slightly smaller than the Jumbo Rolling StrongBox, it meets some USA airline carry-on requirements. 14 x 9 x 23½", 12 lbs .....313.95

#### Compact Rolling StrongBox (TA651B)

For photographers who don't need a full-sized StrongBox. Its dimensions are 14 x 9 x 21½", and it weighs 11 lbs .....274.50

### ROLLING BACKPACKS



This Rolling Backpack has the advantages of a wheeled camera bag and a photographer's backpack. It has ball bearing in-line skate wheels and telescoping handle for easy travel, but quickly converts to a backpack via a hidden Tuck-A-Way backpack harness when needed. The QuickClip system holds and protects professional-sized tripods.

#### Rolling Photo Traveler Backpack (TA677B)

This extremely functional, high-capacity case holds numerous cameras, large telephoto lenses and a multitude of related equipment. Constructed of water-proofed PowerGrid Cordura, the interior has foam-padded adjustable dividers. Internal Windowpane-Mesh Pockets organize filters, cleaning materials and other small items while a large exterior pocket holds lots of film, accessories or clothing. Dimensions are 12¾ x 10¼ x 21", it weighs 10 lbs. 11 oz .....338.95



For Any Inquiries Regarding Your Order, Call Our Customer Service:  
(800) 221-5743 • (212) 239-7765 • FAX: (800) 947-2215 • (212) 239-7549

# TAMRAC

## LARGE CASES



### ROLLING STUDIOS

Rolling Studios roll smoothly on ball-bearing, in-line skate wheels, improving mobility while decreasing the burden of carrying heavy equipment. Light stands, tripods, umbrellas, strobe or tungsten light heads and power packs are stowed safely in the foam-padded, plastic-armored, partitioned main compartment. Two internal Windowpane-Mesh pockets provide quick access to small accessories while a large, exterior zippered pocket provides convenient storage for other accessories. Constructed of Ballistic nylon, Rolling Studios have a foam-padded bottom and sides and are reinforced with tough, plastic armor.

#### Super Rolling Studio (TA662B)

The Super Rolling Studio can hold stands and tripods up to 43" along with multiple power packs. Its dimensions are 20¼ x 14½ x 45¼", it weighs 24 lbs. 8 oz.....**456.95**

#### Medium Rolling Studio (TA661B)

Accommodates stands and professional tripods up to 35" long, two power packs, multiple lights, umbrellas and accessories. 18½ x 14¼ x 39". It weighs 20 lbs. 8 oz .....**404.95**

#### Rolling Studio (TA660B)

The Rolling Studio features a telescoping handle, and holds a tripod, a few lights, stands, umbrellas and a power pack. Its dimensions are 19½ x 14¼ x 32¾". It weighs 19 lbs...**378.95**

BAGS

603

### SPEEDROLLER 2



This rolling case provides protection and fast access to two SLRs with lenses attached, multiple additional lenses, accessories and a laptop, and is carry-on compatible. The ballistic nylon outer shell and rigid, plastic-armored walls provide extreme protection. A separate, foam-padded outer pocket holds a laptop up to 13 x 11 x 2". Internal, adjustable, foam-padded dividers are customizable to fit a wide variety of photo equipment. Also features: Windowpane-Mesh pockets for accessories, industrial-strength telescoping handle, and ball-bearing, in-line skate wheels for a smooth, stable ride. Available in Black. 14 x 9 x 22"; weighs 11 lb. 12 oz.

SpeedRoller 2 (TA5552) .....**CALL**

### STRONGBOX SERIES

These tough and rigid photographer's travel cases are lightweight yet they can hold at least 10 times their weight. Construction is built around a completely seamless protective tub made of rigid, ABS plastic. The inside has a smooth lining and is completely foam padded. The adjustable, foam-padded dividers use Velcro to allow complete customization of the interior to match the equipment. They feature multiple accessory pockets that hold filters and accessories in easy reach, self-healing nylon coil zippers, heavy-duty, quick-release buckles, sturdy leather-wrapped carrying handles and a removable shoulder strap.



#### "El Grande" StrongBox (TA648)

With 2,580 cubic inches of storage space and 8" of internal height, this StrongBox can be customized to hold medium format, digital and film cameras. It can even hold some 4 x 5 cameras and accessories. Dimensions are 23 x 17½ x 10½". It weighs 11 lbs. 6 oz.....**319.95**

#### "Unlimited" StrongBox (TA646B)

An ideal case for a broad assortment of equipment and assignments. Suitable for both 35mm and medium format use. It is also designed to hold a 4x5 field camera, a lens boards and accessories. Dimensions are 21¼ x 14 x 9", and it weighs 9 lbs. 2 oz.....**293.95**

#### "Double Format" StrongBox (TA644B)

A compact yet comprehensive solution for photographers with either medium format or 35mm systems. It has a space-saving design with an abundance of foam-padded adjustable dividers. Dimensions are 16¼ x 11 x 9", and it weighs 6 lbs.....**221.95**

ORDER & INFO. (212) 502-6340 • FAX: (212) 239-7770 (800) 947-7008  
**1-800-290-6750 • www.bhphotovideo.com**



# TAMRAC

## CAMERA STRAPS

BAGS

604

All Tamrac camera straps are designed to work with slotted connectors and standard, split-ring connectors. All straps with quick connectors can be interchanged with any other Tamrac strap allowing cameras to be quickly changed with various strap systems.

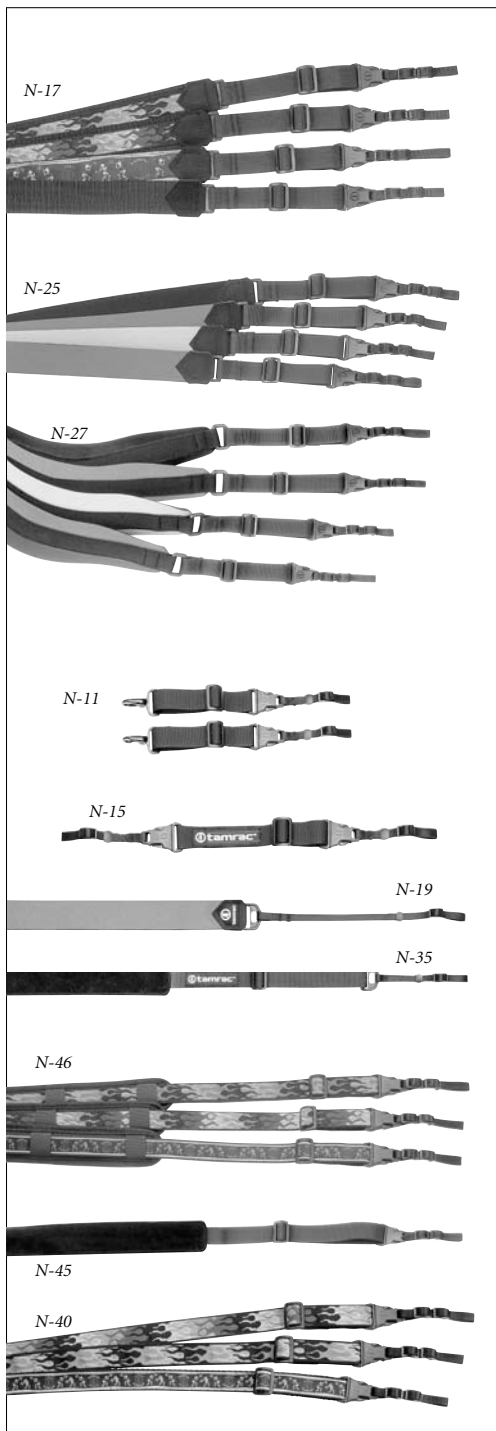

### Anti-Slip Quick-Release

#### Camera Strap (TAN17)

A strong, lightweight camera strap with two full-length rubber tracks woven into the material to prevent shoulder slip. Quick-release buckles allow the camera to be removed for tripod or copystand work and can be interchanged with all other Tamrac quick-release systems. Adjusts to 41" in length. Available in Black, Red Flame, Silver Flame, and Flash colors. It weighs 3 oz .....**16.95**

### Shock Absorber, Neoprene

#### Camera Strap-Quick-Release (TAN25)

Made of tough and stretchy neoprene rubber. They are easy on the neck and very comfortable as the neoprene acts as a shock absorber. The quick-release buckles allow flexibility and interchange with all other Tamrac quick-release systems. Adjusts to 42" in length. Available in Black, Silver, Red, and Blue colors. It weighs 3 oz.....**15.50**

### Boomerang Strap (TAN27)

A wide, contoured neoprene camera strap that cushions the neck from heavy cameras. The contoured "Boomerang" shape follows the curve of the neck or shoulder while distributing the weight over a wide area. The quick-release buckles allow interchange between other Tamrac quick-release systems. Adjusts to 44" in length. Available in Black, Silver, Red, and Blue colors. It weighs 3 oz.....**19.50**

### Backpack Camera Straps (TAN11)

These straps clip to the "D" rings on backpack harnesses to hold cameras ready for quick access. They have quick-release connectors and interchange with all Tamrac quick-release straps.....**12.50**

### Camera Hand Strap with Quick-Release (TAN15)

An excellent way to handle a camera when a neck strap is not required. The quick-release connectors match those on other Tamrac quick-release straps allowing easy interchange for multiple cameras. Weighs 1 oz.....**9.95**

### Neoprene Camera Strap (TAN19)

Made of tough, stretchy neoprene rubber which acts as a shock absorber, the N-19 is easy on the neck for all-day comfort. The easy attachment system has strong nylon webbing that fits through the camera connectors and securely holds your camera. Adjusts to 39" in length. Available in Black, Silver, and Blue colors. It weighs 2 oz...**11.50**

### Foam-Padded,

#### Leather Camera Strap (TAN35)

The non-slip suede leather keeps the equipment from slipping off the shoulder while the thick foam pad absorbs and distributes the weight. The easy attachment system has strong nylon webbing that fits through the camera connectors and securely holds your camera. Adjusts to 51" in length.....**15.50**

### Slim, Soft Quick-Release

#### Camera Strap (TAN40)

Lightweight, slim and at only 1" in width, very comfortable on your neck. The quick-release buckles allow flexibility and easy removing in situations when a strap is not needed. Available in Red Flame, Silver Flame, and Fash. It weighs 3 oz.....**15.95**

### Foam-Padded, Leather

#### Camera Strap with Quick Release (TAN45)

The ultimate in camera carrying comfort. The thick foam pad absorbs and distributes the weight, while the non-slip suede leather keeps the equipment from slipping off the shoulder. Quick-release buckles allow flexibility for copy stand, tripod or other situations where a strap is in the way. Adjusts to 50" in length. Available in Black and Brown colors. It weighs 3 oz .....**16.95**

### Superlight, Foam-Padded Strap with Quick Release (TAN46)

The adjustable, thick foam pad absorbs and distributes the weight while the non-slip lining keeps the equipment from slipping off the shoulder. Quick-release buckles allow flexibility for copy stand, tripod or other situations when the strap is not needed. Adjusts to 49" in length. Available in Silver Flame, Red Flame, and Flash colors. It weighs 1 oz.....**18.50**



EQUIPMENT LEASING AVAILABLE

# TAMRAC

## ACCESSORIES

BAGS

605

### Photographer's ToolPak (TA125)

Made of Windowpane-Mesh to visibly hold filters, batteries, pens, pencils, screwdrivers, a notebook and most of the small accessories that are so difficult to find when you need them. It attaches to a ZipDrop pocket of many Tamrac Pro Systems bags .....**22.95**

### Folding Filter Wallet (TA5329)

Designed to keep up to 8 filters organized, protected and available. It holds filters up to 82mm, offering quick access. When folded, it becomes a compact wallet-sized case that can fit in most camera bags. Black color. Its dimensions are 9 x 1 1/4 x 4 1/2", and it weighs 6 oz.....**15.50**

### S.A.S. Phone Case (TAMX5323B)

Perfect for many mobile phones. It quickly attaches to both Modular Accessory System (M.A.S.) Strap Accessory System (S.A.S.) compatible products, or any belt. 3 x 1 1/4 x 5 3/4", it weighs 2 oz.....**5.95**

### Camera Bag Belt Restraint Strap (TAS111)

This webbing strap uses quick-release snap hooks to clip to the "D" rings of your Tamrac bag. This keeps the bag from swaying out away from your side. Quick-release buckles allow fast removal. 3 oz.....**10.95**

### Cam Locking Cinch Straps (TAS113)

These cinch straps attach accessories to Tamrac products that have lash tabs. Two straps to a package. Available in Black and Purple colors. 1" wide and 22" long, it weighs 1 oz.....**4.50**

### Pro Series Camera Bag Harness (TAS114)

This padded harness clips to the steel "D" rings on any Tamrac Pro Systems camera bag and allows them to be carried comfortably as a backpack. Two adjustable, sliding, foam-padded shoulder pads provide a comfortable, custom fit. Made of strong 2" wide nylon webbing, the harness attaches securely with Tamrac's 200 lb. test Dragon Snap hooks for easy on and off. It weighs 13 oz.....**29.50**

### Accessory Shoulder Strap (TAS115)

This webbing strap has a non-slip patch and Tamrac's exclusive DragonSnap Spring Hooks for increased security. It comes complete with S.A.S. attachment slots. It weighs 3 oz.....**8.95**



### BioCurve Foam-Padded Shoulder Strap (TAS140)

Created for the Extreme Series Hip Packs and Backpacks, this 59" long foam-padded shoulder strap is ergonomically shaped to comfortably fit the natural curve of your shoulder. A non-slip leather patch covered in PowerGrid Cordura has Tamrac's exclusive DragonSnap Spring Hooks to assure secure attachment to hip packs, backpacks, and camera bags. Comes complete with Strap Accessory System (S.A.S.) attachment slots. The strap weighs 4 oz.....**15.95**

### Classic Padded Leather Shoulder Strap (TAS142)

The original 61" long classic shoulder strap made of thick, non-slip leather with extra thick foam padding to cushion your shoulder from heavy loads. The quick-release snap hooks and 5000 lb. test aircraft seat belt webbing make it easy to use and extremely durable. Complete with S.A.S. attachment slots. Weighs 9 oz.....**15.95**

### Chest Harness System (TAS500)

Model S-500 allows Holster Packs (models 519, 517, 515, 514) and Zoom Pack 19 (model 5519) to be worn on your chest to capture photo opportunities during rigorous activities like climbing, skiing, kayaking, or biking. It weighs 14 oz.....**9.95**

### RollerProp (TARP151)

Attaches to the back of Rolling StrongBoxes and swings open to provide an easy access while positioned at a 60° angle. It does not change carry-on size. For model 651 and 691. It weighs 1 lb. 8 oz.....**35.95**

### RollerProp (TARP152)

Same as above, for models 652 and 692. It weighs 1 lb. 9 oz.....**35.95**

### RollerProp (TARP154)

Same as above, for models 654, 694 and 695. It weighs 1 lb. 10 oz.....**35.95**

ORDER & INFO. (212) 502-6340 • FAX: (212) 239-7770 (800) 947-7008  
**1-800-290-6750 • www.bhphotovideo.com**



# TAMRAC

## MODULAR ACCESSORY SYSTEM (M.A.S.)

Tamrac's Modular Accessory System offers additional accessories that quickly attach to any belt or Tamrac products that have the M.A.S. quick-attachment system. Using a security flap with snaps, these accessories are easy to attach and provide a fast and secure method for customizing many backpacks, hip packs, shoulder bags and the M.A.S. padded Modular Accessory Belts. Whether it's extra lens cases, a water bottle carrier, or filter pack, you can customize your carrying system to match your exact requirements.

BAGS

606



**M.A.S. Medium Lens Case (TAMX5375)**  
Medium zipper-closing, foam-padded lens case with weather flap for lenses up to 4½" long and filter size of 82mm. It quickly attaches to the Modular Accessory System or any belt. Supplied with a handle, rain-flapped zipper and a padded bottom. Its dimensions are 3¼ x 5¼", it weighs 3 oz. ....**12.50**

**M.A.S. Large Lens Case (TAMX5378)**  
Larger version of above, for lenses up to 6¼". 3¾ x 6¾", it weighs 4 oz. ....**13.50**

**M.A.S. X-Large Lens Case (TAMX5379)**  
Extra large version of above, for lenses up to 8¾". 4½ x 9¾", it weighs 6 oz. ....**17.95**

**M.A.S. Small Accessory Pocket (TAMX5382B)**  
This foam-padded, fast-access pocket is perfect for camera backs and other small accessories. It quickly attaches to the Modular Accessory System or any belt. It's dimensions are 4½ x 2½ x 5¼", and it weighs 3 oz. ....**13.95**

**M.A.S. Medium Accessory Pocket (TAMX5384B)**  
Same as above, but slightly larger. 4½ x 3 x 7¾", it weighs 4 oz. ....**17.95**

**M.A.S. Film Management Zip Pack (TAMX5387B)**  
Holds 20 rolls of film in one of two zippered compartments, keeping exposed and unexposed film separate from one another. 6 x 5½ x 8¾", it weighs 7 oz. ....**23.50**

**M.A.S. Filter Belt Pack (TAMX5388B)**  
Provides quick access to five filters up to 82mm in separate foam-padded slots. 4¾ x 2¾ x 4¾", it weighs 3 oz. ....**17.95**

**M.A.S. Water Bottle in Padded Carrier (TAMX5398B)**  
A 20 oz. water bottle in a foam-padded carrier. 3½ x 8¾", it weighs 5 oz. ....**15.95**

**M.A.S. Medium Modular Accessory Belt (TAMBX5397B)**  
44 x 4¾". Fits waist sizes up to 45". Works with all Modular Accessories (except backpack pockets). It holds models 514, 515, 517, 519, 5514, 5516 and 5519 Zoom Paks. A 2" adjustable web belt and quick-release buckle are incorporated into a foam-padded belt system. The belt can also be threaded through gear that can take the 2" quick-release buckles. 10 oz. ....**22.95**

**M.A.S. Large Modular Accessory Belt (TAMBX5399B)**  
Same as above, but slightly larger. It's dimensions are 48 x 5". It fits waist sizes up to 58", and weighs 11 oz. ....**22.95**

**M.A.S. Medium Raincover (TAMX352B)**  
For extra security when using the Photo Backpack models 757, 767, 777, and 5275. It provides a double-waterproof coated PowerGrid nylon that protects everything except for the back of the backpack and the harness. Folded into its pouch, it attaches to any M.A.S. backpack attachment points. 5¼ x 1½ x 8¾". It weighs 7 oz. ....**CALL**

**M.A.S. Large Raincover (TAMX354B)**  
Same as above, but larger. For Photo Backpack models 777, 787, 5277, and 5278. 5 x 2½ x 8¾". It weighs 9 oz. ....**42.50**

**M.A.S. Belt Harness (TAMX373B)**  
An adjustable, padded belt harness that keeps M.A.S. belts securely on the hips. Adjustable, sliding, foam-padded shoulder pads provide a comfortable, custom fit. It is constructed of strong nylon. ....**25.50**



# TAMRAC

## MODULAR ACCESSORY SYSTEM (M.A.S.)

### M.A.S. Tripod Boot (TAMX357B)

Allows a large tripod to be connected to the Modular Accessory System on the Rolling StrongBox Series. Two cam locking cinch straps and a drawstring cord help secure the tripod. 5¼ x 5¼ x 15¼" .....45.75

### M.A.S. Large Padded

#### Extreme Series Backpack Pockets (TASPX777B)

For additional storage space for the Extreme Series and Expedition Series Backpacks. It has two-way zippers beneath a storm flap for fast access and will hold lenses, extra equipment, or personal items. Large mesh exterior pockets provide easy access to small items while on the move. Fits all backpacks except for models 759, 5273, 5274, 5275 and 5747. 6 x 3¾ x 13½", 7 oz. each.....55.50

### M.A.S. Extra Large Padded

#### Extreme Series Backpack Pockets (TASPX787B)

Same as above, but larger. Fits all backpacks except for models 767, 777, 759, 5273, 5274, 5275 and 5747. Dimensions are 6" x 3" x 16¼", 9 oz. each.....63.95



BAGS

## STRAP ACCESSORY SYSTEM (S.A.S.)

### Customize your system with Tamrac's S.A.S. System

Tamrac's Strap Accessory System has components that quickly attach to the shoulder strap of nearly all of our products and to the harness of most of our backpacks to allow you to personalize and customize your Tamrac bags and packs. Most S.A.S. components can also be attached to the Modular Accessory System (M.A.S.) attachment slots giving you even more customizing options. Like the M.A.S. components, the S.A.S. accessories easily attach using a secure, quick-attachment system with snaps. If you're tired of searching for film or fumbling for your phone, S.A.S. accessories are great carrying solutions to make getting 'the shot' easier.

### S.A.S. Phone Case (TAMX5323B)

Perfect for holding a cell phone. 3 x 1¼ x 5¼". It weighs 2 oz.....5.95

### S.A.S. Quick-Load

#### Film Pack 3 (TAMXS5360B)

Provides quick access to three 35mm film canisters that are loaded from the top and pulled out from the bottom through a special trap door. Dimensions are 2¼ x 1½ x 4¾". It weighs 2 oz.....9.50

### S.A.S. Quick-Load

#### Film Pack 5 (TAMXS5361B)

Same as above but slightly larger, it holds five 35mm film canisters. Dimensions are 2¾ x 1½ x 7½". It weighs 3 oz.....15.90



### S.A.S. Compact Filter Case (TAMXS5363B)

Provides quick access to three filters up to 77mm in size in separate foam-padded slots. Secure, quick-release buckle closure keeps them within easy reach. Quick attachment to any belt or our Strap Accessory System. 4½ x 1½ x 4¾", it weighs 2 oz.....11.50

### S.A.S. Super

#### PDA/Utility Pocket (TAMXS5366B)

Designed to hold a PDA, small flashlight, Leatherman or Swiss Army knife, and pens or pencils, this tool kit will keep you organized and keep necessary tools within easy reach. 4¾ x 1¼ x 7½", it weighs 3 oz.....15.50

607

# TENBA

## PROFESSIONAL SHOULDER BAGS

BAGS

608



**Travelite S-1:** Ideal carrying case for an SLR camera with standard zoom lens attached. The zippered front pocket has place for some cables, film or batteries. Two exterior side mesh pockets provide extra space for other accessories. It is 7.25 x 5.75 x 5" and weighs 15 oz. Available in Black/Blue (TETS1BB), Black/Gray (TETS1BG), and Black/Green (TETS1BGR) colors .....**24.95**

**Travelite S-2:** Slightly larger than the S-1, the S-2 is perfect for an SLR camera with a medium zoom lens attached plus a flash. It has a zippered front pocket and two exterior side mesh pockets. It's dimensions are 7.25 x 7.75 x 4.75" and it weighs 1 lb. Available in Black/Blue (TETS2BB), Black/Gray (TETS2BG), and Black/Green (TETS2BGR) colors .....**28.95**

### Travelite Shoulder Bags

Carefully constructed with rugged Tenba DuraTek exterior fabric and gentle Tenba SofTek interior fabric, Travelites are ideal for the grab-and-go lifestyle. There's plenty of room for accessories too, as they feature many built-in EasySee mesh pockets. They are available in three color combinations: Black/Blue, Black/Gray or Black/Green.

**Travelite S-3:** Ideal for an SLR camera with a medium zoom lens attached plus a flash. In addition to the zippered front pocket and two exterior side mesh pockets, the S-3 has a mesh pocket inside the lid. It is 7.25 x 9 x 5.75" and weighs 1.2 lb. Available in Black/Blue (TETS3BB), Black/Gray (TETS3BG), and Black/Green (TETS3BGR) colors .....**33.95**

**Travelite S-4:** The S-4 holds an SLR camera with medium zoom lens attached, a second lens, plus a flash. It features a zippered front pocket and mesh pocket inside the lid and two exterior zippered side pockets. It's dimensions are 8.25 x 11.25 x 5.75" and it weighs 1.5 lb. It is available in Black/Blue (TETS4BB), Black/Gray (TETS4BG), and Black/Green (TETS4BGR) colors.....**39.95**



**Travelite S-5:** Slightly larger, the S-5 is ideal for an SLR, four lenses and a medium flash. 8.75 x 12 x 7.5", it weighs 1.5 lbs. Available in Black/Blue (TETS5BB), Black/Gray (TETS5BG), and Black/Green (TETS5BGR) colors .....**46.95**

**Travelite S-6:** Ideal for two SLRs, four lenses and a small flash. 9.75 x 14 x 7.5", it weighs 2.5 lbs. It is available in Black/Blue (TETS6BB), Black/Gray (TETS6BG), and Black/Green (TETS6BGR) colors .....**56.95**

**Travelite S-7:** The largest Travelite, the S-7 is perfect for carrying two SLR cameras, five lenses and a medium flash. 10.75 x 16.25 x 8", it weighs 3 lbs. Available in Black/Blue (TETS6BB), Black/Gray (TETS6BG), and Black/Green (TETS6BGR) colors .....**66.95**

### D-Series Shoulder Bags

With the laptop-ready D-Series shoulder bags you can carry a laptop up to 17" in the computer slot which features the Tenba-exclusive rear Shock Dispersion Wall, as well as a complete SLR camera system. Closed cell cross-linked foam is used on all sides to make this thickly padded bag more durable. The Double Top System adds protection against sand and snow. Features include a full access top that opens in any direction, outside zipper pockets on the back for holding papers, and "pen and pad" slots on the inside of the front pocket. The bag has a 2" wide adjustable shoulder strap with a non-skid liner made of golf glove material as well as a removable rubberized hand grip.

- ◆ Large front organizer compartment to hold business cards, diskettes, pens and other items
- ◆ Quick access side zipper access to laptop compartment

- ◆ Two front zippered pockets to keep papers organized and a full length zipper pocket
- ◆ Different inserts available
- ◆ Foam padded wood bottom liner
- ◆ Zippered back pocket with wicker surface

**D-12C (TED12C):** Up to 12" laptop, motorized camera body, 3 lenses, flash and up to 10 media cards. 80 cubic inches of zippered storage. Interior dimensions are 13 x 13 x 10.5" (LxHxD), weighs 5.3 lbs.....**157.95**

**D-15C (TED15C):** Up to 15" laptop, motorized camera body, 4 lenses, flash and up to 20 media cards. 125 cubic inches of zippered storage. Interior dimensions are 14.5 x 14.5 x 10.5" (LxHxD), weighs 7 lbs.....**196.95**



**D-17C (TED17C):** Up to 17" laptop, 2 motorized camera bodies, 5 lenses, flash and up to 24 media cards. 150 cubic inches of zippered storage. Interior dimensions are 17.5 x 15 x 11" (LxHxD), weighs 8 lbs.....**234.95**



[www.bhphotovideo.com](http://www.bhphotovideo.com)



# TENBA

## PROFESSIONAL SHOULDER BAGS

### ProDigital MetroPak Carry Gear

MetroPak Carry Gear is designed for the photojournalist that needs to work fast, wants big capacity, lots of flexibility and room for a computer. When speed is the key, you'll appreciate the Quick Access Top that lets you reach in and grab the tool you need. And, the huge side bucket pockets can hold almost anything, including media, in secured compartments. When you need to select and transmit images, just pull out your computer and go.

#### D-Series P-859C (TEP859C):

Carry a laptop up to 15" in the rear computer slot, two motorized camera bodies, three lenses, a flash and up to 12 media cards. The P-859C has 115 cubic inches of zippered storage plus huge bucket pockets. It's dimensions are 15 x 12 x 10.5" and it weighs 2.8 lb .....**184.95**

#### D-Series P-899C (TEP899C):

With the P-899C, you can carry a laptop up to 17", two motorized camera bodies, four lenses, a flash and up to 12 media cards. It features 130 cubic inches of zippered storage plus huge bucket pockets. It's dimensions are 18 x 14.5 x 10.5" and it weighs 2.8 lb .....**199.95**



BAGS

609

### Metro Pak II Camera Bags

Looking to create the very best press photographer's bags in the world, Tenba introduced the quick working, easy-to-transport, and rugged Metro Pak II bags. Each can hold an emergency services scanner or 2-way radio, and longer lenses such as an 80-200mm f2.8 lens. Divider inserts are smooth sleeves for camera lenses or bodies with a padded bottom, so your gear is still protected when the insert is removed. The outer shell is made from waterproof and lightweight Cordura; the back pocket and panels are made of canvas and smooth nylon. Metro Pak II bags have a large industrial mesh pocket for papers, 6 small side pockets, and 4 inside divider pockets to hide your keys, passport, film, emergency cash and papers. They all feature large Velcro patches to hold down the flaps of the top and side pockets; quick and secure snap buckles; a sturdy, hard, protective bottom fully lined, foam padded and wood bottom protection; and a comfortable 2" wide shoulder strap.



**Metro Pak II P839 (TEP8392B):** A compact, easy-to-carry bag. It carries one 35mm SLR, three lenses, a flash and up to 6 media cards. Interior dimensions are 12 x 9 x 8.5", and it weighs 4.1 lbs .....**118.95**

**Metro Pak II P859 (TEP8592B):** A large day bag that is perfect for carrying two 35mm SLR body, four lenses, a flash and up to 6 media cards. Interior dimensions are 16 x 9 x 8.5", and it weighs 4.8 lbs .....**133.95**

**Metro Pak II P899 (TEP8992B):** This full SLR system bag has ample room for a large system: two 35mm SLR cameras. 5 lenses, a flash and up to 6 media cards. Interior dimensions are 18 x 9 x 8.5", and it weighs 5.1 lbs .....**148.95**

## HARNESSES ACCESSORIES



#### 5001 BPH Long Backpack Harness (TE5001)

Convert shoulder or waist belt bags to a backpack. Shoulder straps are wide, mesh lined for coolness, with a round yoke for extra comfort. The snap hooks attach to the bottom and rear corners of your bag .....**38.95**

#### 5003 BPH-S Short Backpack Harness (TE5003)

Convert Tenba's briefcases, camera bags, chest paks or waist belts to a backpack. The backpack harness provides a comfortable and convenient way to carry bags as a backpack. If you have to carry your gear for long distances without shooting, converting with the backpack harness system may be a more practical and economical solution than purchasing a backpack. ....**28.95**

ORDER & INFO. (212) 502-6340 • FAX: (212) 239-7770 (800) 947-7008  
**1-800-290-6750 • www.bhphotovideo.com**



# TENBA

## BACKPACKS

BAGS

610

### ProDigital BackPack Carry Gear

Designed for working pros, these backpacks help you get to your gear faster than ever because everything can be placed where you want it for maximum efficiency. With the tug of a front or side zipper, external Quick Access features let you get to your laptop and most useful tools without opening the backpack.

#### DB-15C (TEDB15C)

Holds a laptop up to 15", a motorized camera body, 4 lenses, a flash and accessories. Dimensions are 14 x 19 x 10½" .....**199.95**

#### DB-17C (TEDB17C)

Holds a laptop up to 17", two motorized camera bodies, 5 lenses, a flash and accessories. Dimensions are 15 x 22 x 10½" .....**239.95**



DB-15C



DB-17CL

### Photographers Business Companion

A minimalist backpack with great styling, the Photographer's Business Companion has lots of room for business papers, a laptop for notes, a small digital camera, space for media, batteries, an extra hard drive and much more. Leather trim feels great and gives it a distinctive look.

**DB-15CL (TEDB15CL):** Holds a laptop up to 15", a large point-and-shoot camera, film, batteries and other accessories. 13 x 15½ x 7" (9¼" extended) .....**104.95**

**DB-17CL (TEDB17CL):** Holds a laptop up to 17" laptop, a large point-and-shoot camera, files, papers and more. It has a hidden MP3 player pocket and loops for the remote on the shoulder strap. 13 x 17.5 x 6.5" (9" extended) .....**144.95**

### Pro Traveler II Camera Bags

Created from waterproof, rugged ballistic nylon, Pro Traveler II camera bags feature a double top system, which combine a quick closing rain flap with a second top that zips tightly shut, shielding your equipment from sand and snow. 1000 lb. test nylon webbing holds the top closing side release buckles. A triple composite bottom offers extra shock and vibration absorbency. The Lens Protection Divider System protects cameras with attached lenses while a torsion bar reinforcement prevents the bag from bowing out. It has a removable pocket for film, two top pockets for business cards and filters, and outside zipper pockets for travel papers. Carry your Pro Traveler II with the 2" wide, padded, adjustable shoulder strap or with the cushioned leather hand grip. 4 bottom "D" rings allow you to attach optional accessories. Get an optional backpack harness and carry it as a backpack.



#### FOR 35mm CAMERA SYSTEMS

**Pro Traveler II P695 (TEP695B):** This "super-sized" bag holds two camera bodies, seven lenses, a flash and accessories. It features two camera caddies, two mid-dividers, two side dividers, four tall side dividers and a flat zipper pocket on the back. It's dimensions are 16 x 10 x 8", and it weighs 5 lbs .....**199.95**

**Pro Traveler II 675 (TEP675B):** A large travel bag for the mobile photographer. It holds two motorized camera bodies, six lenses, a flash and accessories. It has two side pockets, a front zipper pocket and a flat zipper pocket on the back, two camera caddies, one mid-divider and two side dividers. Dimensions are 16 x 9 x 7", and it weighs 4.6 lbs .....**179.95**

**Pro Traveler II P655 (TEP655B):** This full-featured pro system bag features two side pockets, a front zipper pocket and a flat zipper pocket on the back, two camera caddies, one mid-divider and two side dividers. It holds two motorized camera bodies, four lenses, a flash and accessories. It's dimensions are 12 x 9 x 7", and it weighs 3.8 lbs .....**159.95**

#### FOR MEDIUM FORMAT SYSTEMS

**Pro Traveler II P696 (TEP696B):** Holds an AF Medium Format Camera Kit, five lenses, two film backs, a Polaroid back and flash. 12 x 9 x 8.5" .....**199.95**

**Pro Traveler II P676 (TEP676B):** Holds an AF Medium Format Camera Kit, four lenses, film back, Polaroid back and flash. 16 x 9 x 7" .....**179.95**

**Pro Traveler II P656 (TEP656B):** Holds an AF Medium Format Camera Kit, three lenses, film back, Polaroid back and flash. 12 x 9 x 7" .....**148.95**



# TENBA

## CAR CASES

Organize and protect your lighting gear with a Car Case. Ideal for transporting equipment by car, they are similar to Air Cases but are lighter in construction and more affordable. Car Cases are built with closed cell foam on rigid air channel plastic and are covered in waterproof, tear-resistant Protek ballistic nylon. They cinch tight with a Velcro closure, and have luggage cart straps, which include two bands of 2" wide webbing that quickly secure your case to any luggage cart without using shock cords.

**Car Case CC28 (TECC28)**

Holds two Dynalite Packs and 3 to 4 heads or Norman 1212 or three Speedotron heads or three Elinchroms 1000-14, or two Powerlights, stands and umbrellas. Three movable dividers. 28 x 14 x 9" .....**237.95**

**Car Case CC17 (TECC17)**

Holds two ProFoto ComPacts or Powerlights and reflectors. One movable divider. 17 x 17 x 8" .....**133.95**

**Car Case CC15 (TECC15)**

Holds Speedotron Pack or 15" flat monitor. 15 x 14.5 x 9" .....**118.95**

**Car Case CC14 (TECC14)**

Holds Bron Pulso Pack. 14 x 10.5 x 8.5" .....**103.95**

**Car Case CCV45 (TECCV45)**

Holds 4 x 5 View camera. PP11 included. 19.5 x 15.5 x 11" .....**185.95**

**Car Case CC22 (TECC22)**

Holds 22" reflectors, flexfills, muslin. 22 x 22 x 8" .....**185.95**

**Car Case CC AirMax 2000 (TECCA2000)**

Accommodates 1 SLR, 3 lenses, a flash and accessories. Features an outside pocket with wide closure buckles that holds accessories and gives the case an inconspicuous appearance. Interior: 19 x 7 x 11". Includes 4 customizable dividers that measure 19 x 7 x 0.75" .....**215.95**

**Car Case CC Multi (TECCM)**

Same as the AirMax 2000, but a bit larger. Interior dimensions are 22 x 8 x 15". It includes four customizable dividers that measure 22 x 8 x 0.75" .....**252.95**

**BAGS****611**

## WEDDING CAR CASE & ACCESSORIES



Specifically created for wedding photographers who want to carry a medium format camera with a strobe, bracket and compendium lens hood all in place and ready to shoot. The camera is set up and held securely in place by three padded moveable inserts, which come with the case, and attach to the long sides with Velcro. Exterior Velcro straps hold a monopod or lightweight tripod. The case includes a Lens Pak, a Magazine Pak and a Padded Insert.

**P2001 Wedding Car Case (TE2001)**

Ballistic nylon exterior. Interior dimensions are 22 x 9 x 11". Weighs 2 lbs. 14 oz.....**222.95**

**P2003 Wedding Car Case (TE2003)**

Similar to the Wedding Car Case with the addition of wheels and a retractable handle for extra transporting ease. Interior dimensions are 22 x 9 x 11". Weighs 3 lbs. 12 oz.....**297.95**

### REPLACEMENT ACCESSORIES

**Lens Pak (TE5057)**

Holds medium format lenses up to 150mm. Top closes with zipper. Belt loop and D rings for shoulder strap. 5 x 5.5 x 3.5". Weighs 5 oz .....**28.95**

**Magazine Pak (TEMP)**

Holds any medium format magazine. Inside pocket holds a dark slide. Belt loop and D rings for shoulder strap. 4 x 5.5 x 2.5". Weighs 4.5 oz .....**21.95**

**Padded Insert (TE5040)**

Comes with two padded movable dividers. It hold three Turbo batteries, lens, backs, Q-flash etc. 12 x 9 x 4.5". Weighs 7 oz .....**25.95**

**ORDER & INFO. (212) 502-6340 • FAX: (212) 239-7770 (800) 947-7008  
1-800-290-6750 • www.bhphotovideo.com**



# TENBA

## AIR CASE ATTACHES

BAGS

612

Constructed of lightweight air channel plastic that is laminated onto high impact resistant closed cell foam, Air Case Attaches are low and flat, and can be either top or side loaded depending upon the kind of equipment you are shipping. The outer shell is made of Protek nylon, a water repellent, puncture resistant, ballistic nylon that is capable of withstanding the most demanding conditions. A high Impact Styrene Rim around the entire edge of the main compartment facilitates loading and unloading. A cushioned leather handgrip lessens hand fatigue with heavy loads. Reinforced, adjustable dividers can be customized to fit your equipment exactly. A double-sided Velcro hook is provided to wrap around the divider ends. These tabs stick to the walls of the Air Case and other dividers.

**1001 Multi Attache Air Case (TE1001)**  
Holds small heads, monolights or a Hasselblad projector.  
24.5 x 17.5 x 10.5" .....**356.95**

**1002 Air Max 1999 Attache Air Case (TE1002)**  
Holds the Sinar A, F1, F2 cameras and lenses. 21 x 16 x 8" .....**311.95**

**1005 MFS Attache Air Case (TE1005)**  
Designed to transport medium format cameras. Multiple dividers can be customized to fit equipment exactly. 18 x 14 x 7" .....**274.95**

**1006 Air Max 2000 Attache Air Case (TE1006)**  
To meet the needs of professional photographers who carry most of their equipment with them, these Air Cases meet the new stringent airline carry-on size regulations. 22 x 13 x 9" .....**296.95**



1002 Air Max



1005

1006

### AIR CASE DIVIDERS

**Divider Set ACD-H (TE5013)**  
Fits the CC17 and CC14 Car Cases, and 1121 and 1123 Air Case Wheelies. One piece. Dimensions: 8 x 13" .....**21.95**

**Divider Set ACD-AMX (TE5012)**  
Set of four dividers with 20 pieces of double-sided Velcro for Air Max 1999 and 2000. Dimensions: 19 x 6" .....**43.95**

**Divider Set ACD-AMXW (TE634193)**  
Set of four dividers with 20 pieces of double-sided Velcro for Wheelie Air Max 1999 and 2000. Dimensions: 19 x 5" .....**43.95**

**Divider Set ACD-M (TEDSAM)**  
Set of four dividers with 20 pieces of double-sided Velcro for Air Case Wheelie Multi. Dimensions: 22 x 8" .....**43.95**



1022 System-1

**1026 View-45 Top-Loading Air Case (TE1026)**  
This air-shippable case holds all 4 x 5 cameras, has 2 movable dividers grooved for a monorail, with a retaining strap. There is plenty of room for film holders, extra lenses, and Polaroid packs. It also holds a Bogen wind machine and carousel trays. 24 x 19 x 13.5" .....**341.95**

### Top Loading Air Cases

Designed to ease access to heavy equipment, lightweight, waterproof Air Cases can be used for carrying lighting equipment, large heads or paks. Just set a case down, open the zippered top, and lower your equipment into the case. Carry by the side handle or top hand grips. Velcro attached dividers leave a 3" clearance on top for light stands and umbrellas. Extra dividers are available.

**1023 Head-3 Top-Loading Air Case (TE1023)**  
Holds complete lighting kit: 3 large Speedotron heads, 3 light stands, 2 umbrellas, plus cables and reflectors etc. Two 12" movable dividers. 30.5 x 16.5 x 10.5" .....**341.95**

**1022 System-1 Top-Loading Air Case (TE1022)**  
1 long and 2 small movable dividers 6" high. Light stands and umbrellas fit into the long section. Power pack and heads fit into the three small sections. 33.5 x 13.5 x 12.75" .....**386.95**

**1021 Head-4 Top-Loading Air Case (TE1021)**  
Holds complete lighting kit: 4 large Speedotron heads, 3 light stands, 2 umbrellas, plus cables, reflectors etc. Two 12" movable dividers. 37.5 x 16.5 x 10.5" .....**386.95**



**ONE HOUR FREE PARKING**  
AT 349 W. 34th STREET (with purchase of \$100 or more)

## PORT EXHIBIT ATTACHES



### Port Exhibit Cases

Cases that safely protect your work and help exhibition committees handle your prints. A vinyl plate is provided to attach a UPS/FedEx label matching your prints with your case. A special pocket is provided to hold your return label. To protect your prints, corners are reinforced and the foam interior is cut out to eliminate pressure on print corners. Separate sheets are provided for up to 6 prints.

#### Port Exhibit 2024 (TEPE2024)

Holds 20 x 24 matted prints.  
24 x 28 x 3" .....297.95

#### Port Exhibit 1620 (TEPE1620)

Holds 16 x 20 matted prints.  
20 x 24 x 3" .....252.95

### Port Air Cases

A great case for presenting your work. Each Port Air front pocket can hold papers, tear sheets and resume. It is a self-contained case that messengers or your reps can use.

**Port Air 1315 (TEI1315):** Large front pocket.  
13.5 x 15.5 x 3" interior size .....155.95

**Port Air 1114 (TEI114Q):** Large front pocket.  
11.25 x 14.5 x 3" interior size .....142.95

### Port Ship Cases

Rugged cases for shipping, carrying and exhibiting your work. The clear vinyl envelope holds an international airway bill. Use to submit your work by overnight express services.

**Port Ship 1315 (TEPS1315)**  
13.5 x 15.5 x 3" interior size .....141.95

**Port Ship 1114 (TEPS1114)**  
11.25 x 14.25 x 3" interior size .....126.95

### Port Carry/Shoulder Cases

Designed to protect expensive leather bound portfolios from the tender mercies of bike messengers, against harsh weather and hard knocks. Your presentation will look great in it. Use as a compact briefcase or as a computer bag. Also, light boxes fit perfectly. The top closes quickly, securely for complete weather protection. All sides, top and bottom are fully padded with Enbazote, a closed cell, cross-linked foam.

Constructed of padded Protek ballistic nylon, tough and enduring, and easy to keep clean. There is a large zippered rear pocket for papers and tear sheets, as well as a leather ID tag for a business card. They include a detachable shoulder strap and a comfortable leather handle.

*NOTE: The Port Case 810, 1114, 1418 and 1620 are NOT rated for shipping. Only the Port Exhibit, Port Ship and Port Air Cases are rated for shipping.*

**Port Case 1620 (TE1620)**  
Holds a 16 x 20" archival box.  
Measures 21 x 17 x 3" (LxHxD),  
weighs 3.2 lbs .....126.95

**Port Case 1418 (TE1418)**  
Holds a 14 x 18" archival box.  
Measures 19 x 15 x 3" (LxHxD),  
weighs 2.10 lbs .....118.95

**Port Case 1114 (TE1114)**  
Holds an 11 x 14" archival box.  
Measures 15 x 12 x 3" (LxHxD),  
weighs 2.4 lbs .....96.95

**Port Case 810 (TE810)**  
Holds an 8 x 10" archival box.  
Measures 11.5 x 9 x 3" (LxHxD),  
weighs 2 lbs .....74.95



### Presta Presentation Cases

The best way to carry artwork and large, flat prints, this good-looking case is constructed of smooth Protek cloth, waterproof coated. Two outside zipper pockets hold a daybook, business cards and pens. Two inside sleeve pockets for flat folders, office papers and promotional cards. Two inside zipper pockets fit stiff hardboard for further protection. The case fully opens with a #5 YKK self-healing coil zipper. The hand strap quickly converts to a shoulder strap by adjusting the two ends of the 500 lb. test polypropylene webbing. To use as a handgrip shorten the strap by pulling up and fastening the ends with the snap button. To lengthen, unsnap the button and pull the strap until it reaches the bottom stop. A comfortable leather handgrip slides over the wide comfortable strap.

**Presta 2026 (TE2026):** 27 x 21 x 2" (LxHxD), weighs 3.2 lbs .....89.95

**Presta 1722 (TE1722):** 23 x 18 x 2" (LxHxD), weighs 2.7 lbs .....81.95

**Presta 1418 (TE1418Q):** 19 x 15 x 2" (LxHxD), weighs 2.2 lbs .....57.95



# TENBA

## TRIPAKS & PADDED PAKS

BAGS

614



### ***Padded Armored TriPaks***

*The easiest way to carry tripods, gear and umbrellas in one large, shippable container. Three zippers form a sturdy hexagon that unzips to form an upright studio wall. Long straps sling over your back for maneuvering through crowded places.*

**PAT-50 TriPak 1031 (TE1031):** Holds 4 light stands or umbrellas (in individual sleeves); a tripod; and accessories in 2 extra pockets. Opens with three zippers so it lies flat; plus, it has webbing sleeves so it can be suspended from an autopole to organize your studio when on location. Unfolded size: 44 x 50"; folded: 14 x 50 x 14". It weighs 11 lbs. 8 oz .....**282.95**

**PAT TriPak 1030 (TE1030):** Same features as the PAT-50 but 8" shorter. Unfolded size: 44 x 42"; folded size: 14 x 42 x 14". It weighs 10 lbs.....**252.95**

### ***Triangular TriPaks***

*Great looking shipping cases. A large flat cloth panel separates two layers of contents; keep your umbrella and light banks separate from your stands and tripod, thereby reducing scratching and abrasion. Haul straps located at the ends for easy loading.*

**TriPak TTP46 (TETTP46B):** Holds Bogen 3364 stands, 3051 tripod with 3625 Pistol Grip head. 46 x 9 x 7 1/2", weighs 4.5 lbs .....**148.95**

**TriPak TTP34 (TETTP34B):** Holds Gitzo Studex with head and Bogen 3361 stand. 34 x 9 x 7.5", it weighs 3 lbs. 8 oz .....**124.95**

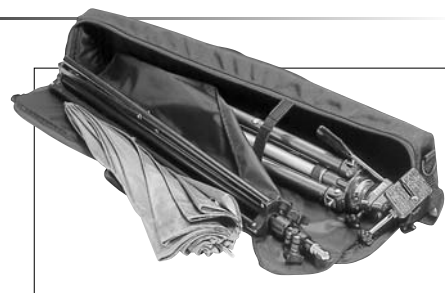

### ***Car Case TriPaks***

*Heavily padded for tripods and lightstands, Car Case TriPaks are perfect for carrying a lot of lighting gear when traveling by car or hauling. Their thick padding protects your gear from normal knocks and bumps. A large flat cloth panel separates two layers of contents, reducing scratching and abrasion. Haul straps are located at the ends for easy loading.*

**Car Case TriPak CCT51 (TECCT51)**  
Small tripods, lightstands umbrellas, and small backdrops. 51 x 11 x 11". Weighs 5 lbs. 4 oz .....**163.95**

**Car Case TriPak CCT46 (TECCT46)**  
Holds all tripods, and normal lightstands. 46 x 11 x 11". Weighs 4 lbs. 12 oz .....**155.95**



Car Case TriPaks

TriPak T385

### ***TriPaks***

*TriPaks are unpadded Cordura sling bags that can carry a tripod plus a lightstand. The carrying strap goes all the way around the bag and can be carried on your shoulder or swung across your back. They feature a zipper that opens to full length, a wood bottom liner, and a small zippered outside pocket to keep small items readily available.*

**TriPak T7010 (TET7010)**  
Holds large tripods, C stands, five 7' umbrellas, or long grip arms. 70 x 10" .....**81.95**

**TriPak T488 (TET488B)**  
Will carry Majestic tripods, light stands, Larson stands. 48 x 8.5" .....**59.95**

**TriPak T385 (TET385)**  
Great for small to medium sized tripods lightstands and umbrellas. 38 x 5.25" .....**47.95**

**TriPak T538 (TET538B)**  
Holds one boom stand and four lightstands. 53 x 8.5" .....**66.95**

**TriPak T388 (TET388)**  
Will carry Gitzo Super Studex or Bogen tripods. 38 x 8.5" .....**51.95**

**TriPak T325 (TET325)**  
Carries small tripods, lightstands, umbrellas and small backdrops. 32 x 5.25" .....**39.95**



**For Any Inquiries Regarding Your Order, Call Our Customer Service:**  
**(800) 221-5743 • (212) 239-7765 • FAX: (800) 947-2215 • (212) 239-7549**

## MISCELLANEOUS CASES

### Long Lens Bags

Easily carry a long lens with or without your SLR attached. Constructed with water resistant Protek ballistic nylon and closed cell, cross-linked foam for the best combination of light weight and protection. Long Lens Bags offer quick-release buckle and/or zipper closures, an outside monopod holder strap, outside and inside pockets for assorted accessories, a padded interior pocket to hold filters safely. It includes an adjustable 2" wide shoulder strap and a comfortable cushioned leather hand grip.

**LL600 Long Lens Bag (TELL600N)**  
Holds 600mm f/4, AF lens and EOS-1 or Nikon F5 and Power Booster. Its dimensions are 7.5 x 23.5 x 7.5" and it weighs 3 lb. 11.2 oz.....**148.95**

**LL400 Long Lens Bag (TELL400N)**  
Holds 400mm f/2.8 or a Nikon 500mm f/4 with hood collapsed, camera and motor drive. Dimensions are 7.5 x 19.5 x 7.5"; it weighs 3 lbs. 3.2 oz .....**133.95**

**LL300 Long Lens Bag (TELL300N)**  
Holds a 300mm f/2.8 AF lens and EOS-1 or Nikon F5 and Power Booster. Its dimensions are 7.5 x 13.5 x 7.5" and it weighs 2 lbs. 4.8 oz .....**118.95**



**BAGS**

**615**

### 2020 Photo Vests

The Photo Vest has a 2" wide built-in waist belt that keeps your equipment stable and secure whether the vest is zippered, closed or open. It has 18 sturdy pockets to organize your gear, plus padded shoulders and a large industrial open mesh back for comfort. The Photo Vest has two "D" rings that allow you to attach a meter or camera, six pen pockets (slots) and one snaphook to keep keys in easy reach.



**Photo Vest 2020 Black Small (TEPV2020SB)** .....**89.95**

**Photo Vest 2020 Grey Medium (TEPV2020MG)** .....**89.95**

**Photo Vest 2020 Grey XLarge (TEPV2020XLB)** .....**89.95**

**Photo Vest 2020 Grey Small (TEPV2020SG)** .....**89.95**

**Photo Vest 2020 Grey Large (TEPV2020LG)** .....**89.95**

**Photo Vest 2020 Black XXLarge (TEPV2020XXLB)** .....**89.95**

**Photo Vest 2020 Black Medium (TEPV2020MB)** .....**89.95**

**Photo Vest 2020 Black XLarge (TEPV2020XLG)** .....**89.95**

**Photo Vest 2020 Grey XXLarge (TEPV2020XXLG)** .....**89.95**

### Air Case Wheelies

Lightweight and tough, Wheelies offer air case protection with multiple dividers that can be customized to fit equipment exactly. Constructed of air channel plastic which is laminated on high impact resistant closed cell foam, they weigh only 25% of comparable Anvil hard shell metal cases. The outer shell is made of water- and puncture-resistant ballistic Protek nylon that is the strongest in the industry. A cushioned leather handgrip lessens hand fatigue with heavy loads. Air Case Wheelies feature 3" long-lasting ball bearing wheels in metal housings, skid plates on the bottom to protect them over stairs and a front bumper to keep them standing level.



#### Top Loading Cases

Large, deep Air Cases that open from the top.

**1123 ACW Head-3 (TEH3W):** Designed for wedding and family photographers, it holds 2 Photogenic power paks and two heads or 3 mono lights, plus all your stands and umbrellas in one neat package. 32 x 21 x 12.7.5" ...**490.95**

**1121 ACW Head-4 (TEH4W):** Holds a complete lighting kit: 4 large Speedotron heads, 3 light stands, 2 umbrellas, plus cables, reflectors etc. It has 2 moveable dividers 12" high. 39 x 17 x 14" ....**534.95**

#### Top Loading Cases - Attaché Style

Shallow style Air Cases which lay flat to open. The inside height is comparatively short.

**1106 ACW Air Max 2000 (TE1106):** Meets the new stringent airline carry-on size regulations. 23 x 9 x 13" .....**475.95**

**1102 ACW Air Max 1999 (TEAMW):** Although no longer carry-on size, this case remains a popular size for today's working professional photographer. Velcro attached dividers let you custom fit your equipment. 23 x 9.25 x 17" .....**490.95**

**1101 ACW Multi (TEMW):** Fits small paks, heads and monolights. Velcro attached dividers let you custom fit your equipment. 26 x 13.5 x 19" .....**449.95**



# TENBA

## ACCESSORIES

BAGS

616

### Rain Covers

Tenba Rain Covers provide full rain protection for all 35mm cameras and motor drives with large fast lenses. The Rain Cover is a no-seam, one piece construction which covers from the lens hood to the viewfinder and wraps under and around the camera. Thin nylon allows you to operate your camera and to change film. A slit beneath the lens allows you to hand-hold the camera or mount the lens on a tripod. You can easily see through the clear plastic viewfinder, and operate the camera through the nylon pack cloth. The Rain Cover stores in a small belt pouch.



Rain Cover RC14

**Rain Cover RC9 (TERC9):** For camera with 28-80mm lens and hood. 9" long.....**39.95**

**Rain Cover RC14 (TERC14):** For camera with 80-200mm lens and hood. 14" long.....**39.95**

**Rain Cover RC18 (TERC18):** For camera with 300mm lens and hood. 18" long.....**39.95**

**Rain Cover RC24 (TERC24):** For camera with 400mm lens and hood. 24" long .....**51.95**

**Rain Cover RC26 (TERC26):** For camera with 600mm lens and hood. 26" long .....**66.95**

### Misc. Accessories

#### D-Series Lens Cup (TELCD)

Accessory removable padded lens cup for D-series bags. Keeps in place with "hook and loop" fabric on one side .....**3.95**

#### Shoulder Strap for D-Series (638-163)

Padded comfort wedge shoulder strap for D-series bags .....**CALL**

#### P5053 Tie Straps (TE5053)

Two sturdy 1" wide nylon webbing straps, 36" long. Strap on a tripod by attaching through "D" rings.....**7.95**



### Heavy Sand Bags

Use these to hold down lightstands, cables and other objects on the set. Constructed like a saddle bag; two pockets can be filled with sand or lead shot to provide weight. Each pocket closes with two zippers that open in opposing directions so no sand leaks out. A handstrap on top opens with a side release buckle, lets you securely attach the saddle bag to a lightstand leg. (Note: Sand Bags do not include sand or lead shot.)

**Tenba Heavy 10 (TE10)**  
Double sided 10x7" saddle type bag with handle (empty), Black .....**30.95**

**Tenba Heavy 20 (TE20)**  
Double sided 10x10" saddle type bag with handle (empty), Black .....**40.95**

**Tenba Heavy 30 (TE30)**  
Double sided 12.5 x10" saddle type bag with handle (empty), Black....**41.95**

### Travelite Ultra-Compact Point & Shoot Carry Gear

Constructed with rugged DuraTek exterior fabric and gentle Tenba SofTek interior fabric and shock-absorbing NeoTek, Travelites are ideal for the grab-and-go lifestyle. Your camera is easily accessed through Tenba's DryEdge Top Access System, the quickest way to get your gear and still protect it against inclement weather. A DoubleLock belt fastener ensures a snug and secure fit on your belt or strap.

**Travelite PS-1:** Dimensions are 3½ x 3 x 1¼". Available in Black/Blue (TETPS1BB), Black/Green (TETPS1BGR), and Black/Gray (TETPS1BG) colors .....**8.95**

**Travelite PS-2:** Dimensions are 4¾ x 3¾ x 1.4". Available in Black/Blue (TETPS2BB), Black/Green (TETPS2BGR), and Black/Gray (TETPS2BG) colors .....**9.95**

**Travelite PS-3:** Dimensions are 5 x 3¾ x 1.7". Available in Black/Blue (TETPS3BB), Black/Green (TETPS3BGR), and Black/Gray (TETPS3BG) colors .....**10.95**

**Travelite PS-4:** Dimensions are 5½ x 4 x 2". Available in Black/Blue (TETPS4BB), Black/Green (TETPS4BGR), and Black/Gray (TETPS4BG) colors .....**11.95**

**Travelite PS-5:** Dimensions are 6 x 4 x 2¼". Available in Black/Blue (TETPS5BB), Black/Green (TETPS5BGR), and Black/Gray (TETPS5BG) colors .....**14.95**

**Travelite PS-6:** Dimensions are 6½ x 5 x 2¼". Available in Black/Blue (TETPS6BB), Black/Green (TETPS6BGR), and Black/Gray (TETPS6BG) colors .....**16.95**



EQUIPMENT LEASING AVAILABLE

## ESQUIRE / DAKOTA COLLECTION

### ESQUIRE LEATHER COLLECTION

The genuine top grain sheepskin Esquire Collection camera cases feature a fully padded interior constructed of high-density foam, removable padded dividers, metal heavy-duty hardware and zipper pulls. All larger size bags have a 3-way safety closure system for enhanced security, interior see-thru mesh pockets and an oversized, fully padded super grip shoulder-strap and carry handle for maximum carrying comfort and balance. All Esquire bags come complete with a lifetime warranty.

**Esquire 100 (VIE100):** Fits an SLR with 4 lenses. It includes two zippered interior mesh pockets, a padded exterior front, two side pockets, and a rubber non-skid base. Inner dimensions are 10 x 6 x 5.5"; Front pocket is 9.5 x 4.25 x 1" (LxHxW) .....**63.95**

**Esquire-50 (VIE50):** Accepts an SLR with 2 lenses. Includes a padded exterior, 2 exterior side mesh pockets with bungee cord ball locks. Inner dimensions are 8 x 5 x 4". Front Pocket is 8 x 4.5 x 1" .....**43.95**

**Esquire-35 (VIE35):** Accepts an SLR with its lens attached. Features an adjustable, interior divider, a padded exterior and 2 exterior side mesh pockets with bungee cord ball locks, 2 interior zippered mesh pockets, memory storage pocket, rubber non-skid base and zipper/velcro/ABS clip for secure closing. Its inner dimensions are 4.5 x 5 x 3"; front pocket is 6 x 4 x 1" (LxHxW) .....**39.95**



**Esquire-25 (VIE25)** Accepts most digital point and shoot cameras. Features 2 inside zippered mesh pockets, 2 memory card pockets, belt loop and a hidden key pocket. Inner dimensions are 4.5 x 5 x 3". Front pocket is 4.25 x 4.5 x 1" (LxHxW) .....**29.95**

**Esquire-15 (VIE15):** Accepts most digital point and shoot cameras. Features a shoulder strap, a belt loop, 2 inside mesh pockets for batteries, memory cards or an AC adapter. An inner flap closure offers extra protection. Its inner dimensions are 3 x 5.5 x 3", and the front pocket is 2.5 x 5 x 1" (LxHxW) .....**19.95**

**Esquire-10 (VIE10):** Accepts small to midsize digital or point-and-shoot cameras. Dimensions are 3.25 x 5 x 1.5" (LxHxW) .....**11.95**

### DAKOTA COLLECTION

Inspired by the beauty and ruggedness of the Dakota mountains these water-resistant bags, available in two-tone gray or cobalt blue, feature high density interior foam padding, adjustable removable interior dividers, padded exterior pockets. The larger bags have a 3-way safety closure system, interior see-thru mesh pockets and an oversized, fully padded super grip shoulder-strap and carry handle. All Dakota bags come complete with a lifetime warranty.

**Dakota-999:** Accommodates most SLRs with up to 6 lenses or a full-size camcorder. Interior dimensions are 13 x 7 x 6"; pocket dimensions are 13 x 6 x 1". Available in Black with Blue trim (VID999BBL) and Black with Grey trim (VID999BGR) .....**37.95**

**Dakota-777:** Accommodates most SLRs with 4 lenses or 8mm/VHS-C camcorders. Inner dimensions are 10 x 6.5 x 5.5"; Pocket is 10 x 5.5 x 1". Available in Black with Blue trim (VID777BBL) and Black with Grey trim (VID777BG) .....**32.95**

**Dakota-555:** Accommodates most SLRs with 2 lenses or 8mm/VHS-C camcorders. Inner dimensions are 8 x 6 x 5.5"; Pocket is 8 x 5 x 1". Black with Grey trim (VID555BG) .....**29.95**



**Dakota-444:** Accommodates most SLRs with their lenses attached or digital cameras. Includes belt loop and 2 side mesh pockets. It's interior dimensions are 6 x 6 x 4"; and the pocket is 6 x 5 x 1". Available in Black with Blue trim (VID444BBL) and Black with Grey trim (VID444BG) .....**19.95**

**Dakota-350:** Accommodates larger digital cameras such as the Canon G3 and G5. Includes belt loop and a shoulder strap. It's interior dimensions are 5 x 5 x 3.5"; and the pocket is 4 x 4.5 x .75". Available in Black with Blue trim (VID350BBL) and Black with Grey trim (VID350BG) .....**11.95**

**Dakota-333:** Accommodates most digital/point and shoot cameras. Includes belt loop and a shoulder strap. Interior dimensions 3.5 x 5 x 2.5". Pocket is 3 x 3 x .75". Available in Black with Blue trim (VID333BBL) and Black with Grey trim (VID333BG) .....**9.95**

# VIDPRO

## VIDPRO COLLECTION / COURIER SERIES

### VIDPRO COLLECTION

The Vidpro Collection is the result of over 45 years of manufacturing high-quality accessories for the photographer. It brings you an award-winning combination of protection, comfort and style. Vidpro cases use a deep grain Durahyde material for the outer shell that looks and feels like leather, yet is more durable and water-resistant, and will outlast most other fabrics. All Vidpro bags come with a lifetime warranty.

BAGS

**VID-100 (VIV100Q):** accommodates an SLR with 6 lenses. It's main compartment, pockets and adjustable, removable dividers are fully padded, while the non-slip, oversized, padded, contoured shoulder pad and handle evenly distribute weight for all-day carrying comfort. It has 3 padded exterior pockets and a secure zipper closing system. The interior dimensions are 13 x 8 x 6"; the front pocket is 13 x 4 x 1" (LxHxW) .....**34.95**

**VID-200 (VIV200):** Comfortably fits an SLR with four lenses. It's dimensions are 16 x 9 x 6" (LxHxW). Dimensions of the front pocket are 16 x 4 x 1" (WxHxD) .....**49.95**

**VID-300 (VIV300):** It accepts a full SLR system with two cameras and 5-6 lenses. Dimensions of the main compartment are 18.5 x 10 x 9". Front pocket dimensions are 18 x 5 x 1.5" (WxHxD) .....**56.95**



VID-90

**VID-90 (VIV90):** Accepts an SLR with up to 4 lenses or an 8mm/VHS-C camcorder. The interior dimensions are 10 x 8 x 5.5" (LxHxW). The front pocket is 10 x 4 x 1" .....**29.95**

**VID-80 (VIV80):** Accommodates an SLR with up to 2 lenses or a small 8mm/VHS-C camcorder. Interior dimensions are 8 x 7 x 5.5" (LxHxW). The front pocket is 8 x 4 x 1" .....**27.95**



VID-70

**VID-70 (VIV70):** Perfect fit for a Sony Mavica. Accepts an SLR, digital camera or small camcorder, and features a 3-way carrying system (handle, shoulder strap and belt loop). Interior dimensions 6 x 6 x 4" (LxHxW). The front pocket is 5 x 3 x 1" .....**14.95**

**VID-60 (VIV60):** Accepts a digital or point and shoot camera, or a mini camcorder. Interior dimensions 5 x 5.5 x 3.5". The front pocket is 4.5 x 3 x 1" .....**13.95**

618

### COURIER SERIES

Using only the finest materials, and manufactured with the highest quality, Courier bags are designed to carry a full size SLR with 4 lenses or an 8mm/VHS-C camcorder. These designer bags have two-tone trim, and are tough, compact and lightweight.



**CR-333:** The rugged, water-resistant CR-333 offers an adjustable padded and contoured shoulder strap, a padded carry handle, and a zip down front accessory pocket. It is fully padded with high-density foam for shock protection, zippered security pocket in the back for wallet, papers, etc. and has quick-release buckles for easy access. It accepts a full-size SLR with 4 lenses. It's interior dimensions are 10 x 6 x 5". Black fabric with Copper (VIC333BC), Blue (VIC333BBL) or Grey (VIC333BG) trim .....**23.95**

**CR-222:** Smaller version of CR-333. Dimensions are 8 x 5.5 x 4". Black fabric with Copper (VIC222BC), Blue (VIC222BBL) or Grey (VIC222BG) trim .....**16.95**

### DIGIPRO COMPACT CASES

**DigiPro Kit (VIDK):**

Accepts most digital point and shoot cameras with their batteries, memory cards and AC adapters. 4.5 x 5.5 x 2.5" (LxHxW). The front pocket is 4.5 x 3.5 x 1" (LxHxW). Includes a table-top tripod and cleaning kit .....**CALL**

The Vid-1, 2, 5 and 10 accept small digital point and shoot cameras, have interior padding, a belt loop and a velcro lock for easy closure. The Vid 5 and 10 also include a hand strap and arm strap, a front pocket for additional storage, and a zipper lock for maximum protection.

**Vid-1 (VIV1):** 2½ x 5 x 1" .....**6.50**     **VID-5 (VICPSXS):** 2½ x 4 x 1" .....**9.95**  
**Vid-2 (VIV2):** 2½ x 4 x 1" .....**6.50**     **VID-10 (VICPSS):** 3½ x 5 x 1¼" ..**10.95**



For Any Inquiries Regarding Your Order, Call Our Customer Service:  
 (800) 221-5743 • (212) 239-7765 • FAX: (800) 947-2215 • (212) 239-7549

# ZERO HALLIBURTON

## ALUMINUM CASES

Zero Halliburton aluminum cases are exceedingly strong, yet lightweight. Their strength-to-weight ratio is 4x greater than cold rolled steel, with 1/4 of the weight. Each case features a tough, pre-stressed shell made of aircraft quality aluminum, interlocking tongue-and-groove closure with moisture and dust resistant seal, durable latches, hinges and lock, 2 lb. density polyurethane foam and maximum safety with instant accessibility. These handsome cases are distinctive, and are available in silver exterior finish which is anodized, while the black onyx finish features an equally durable powder paint covering.

The Zeroller is designed for convenience with built-in wheels and a retractable handle. The interior space remains virtually the same. Standard cases include a full set of upper and lower foam, and divider cases include a full set of dividers. Modular cases include a full set of upper and lower foam which can be converted to a divider case with the optional dividers.



BAGS

619

### CASES WITH FOAM

|  |  |
|--|--|
| #100 Case Silver (HA100S) .....169.50  | #107 Case Silver (HA107S) .....234.50          |
| #101 Case Silver (HA101S) .....195.95  | #107 Zeroller Case Silver (HAZR107S) ...307.50 |
| #103 Case Silver (HA103SES).....169.95 | #110 Case Silver (HA110S) .....329.50          |
| #106 Case Silver (HA106S) .....266.50  | #129 Case Silver (HA129S) .....389.95          |

### ZERO HALLIBURTON SPECIFICATIONS

| Model #      | Outer Dimensions L.W.H. | Upper Shell Height | Lower Shell Height | Weight    |
|--------------|-------------------------|--------------------|--------------------|-----------|
| 100          | 12 x 9 x 5"             | 2"                 | 3"                 | 4 lbs.    |
| 101          | 16 x 9 x 7.8"           | 2.5"               | 5.25"              | 6 lbs.    |
| 103          | 18 x 13 x 6"            | 2.5"               | 3.5"               | 6.5 lbs.  |
| 106          | 21 x 17 x 7.5"          | 3"                 | 4.5"               | 11.5 lbs. |
| 107          | 21 x 13 x 7.5"          | 3.75"              | 3.75"              | 8.3 lbs.  |
| 107 Zeroller | 21 x 13 x 8.5"          | 3.75"              | 3.75"              | 8.9 lbs.  |
| 110          | 26 x 18 x 9"            | 4.25"              | 4.75"              | 15.5 lbs. |
| 129          | 29 x 20 x 10"           | 5"                 | 5"                 | 19.8 lbs. |

### Replacement Foam

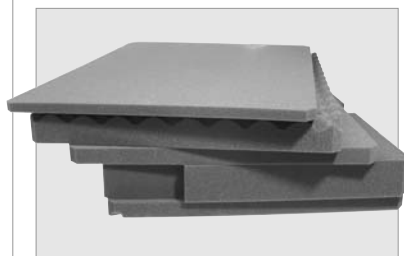

|   |       |
|---|-------|
| Foam Pack for Case #100 (HAFP100) ..... | 14.95 |
| Foam Pack for Case #101 (HAFP101) ..... | 24.95 |
| Foam Pack for Case #103 (HAFP103) ..... | 26.50 |
| Foam Pack for Case #106 (HAFP106) ..... | 39.95 |
| Foam Pack for Case #107 (HAFP107) ..... | 34.95 |
| Foam Pack for Case #110 (HAFP110) ..... | 59.95 |
| Foam Pack for Case #111 (HAFP111) ..... | 46.50 |
| Foam Pack for Case #129 (HAFP129).....  | 77.50 |



**107 Zeroller Case**

- ◆ Exterior Zeroller transport design maintains virtually all interior space
- ◆ Retractable handle assembly of pultruded nylon, withstands 600 pounds of force
- ◆ Heavy duty rubber wheels with ball bearing races assure reliable transport
- ◆ Permits second ZERO Halliburton case to be piggy-backed

# ZING

## CAMERA COVERS & CASES

BAGS

620

*Sleek, lightweight and highly functional, the Zing Collection of camera covers feature neoprene fabric that stretches to create a snug fit, keeping your gear safe from moisture and dirt.*

### SLR Camera Covers

The original, patented Zing design features a one-piece, wrap-around cover that stretches over the lens and self secures without buckles, snaps or zippers. A removable retainer strap clips onto the camera strap and allows the cover to hang out of the way while shooting. All SLR Cover fashion colors are reversible to black. A unique latching system snugs the cover around your single lens reflex camera to provide minimal bulk and maximum protection. While shooting, hang the cover from your camera strap or simply stuff it into your pocket.

#### Standard Reversible SLR Cover

Fits small SLR cameras, including most older models, with a lens up to 3.5" long. It weighs 4.5 oz. Available in Black (ZICSB), Blue (ZICSBL), Burgundy (ZICSBU) and Gray (ZICSG) .....**29.95**

#### Large Reversible SLR Cover

Similar to the Standard SLR Cover, but slightly larger. It fits an autofocus SLR and other large-body cameras with a lens up to 4" long. It weighs 5 oz. Available in Blue (ZICLBL), Burgundy (ZICLBU), Deep Green (ZICLGR) and Gray (ZICLG) .....**29.95**



#### Pro SLR Cover

Fits autofocus and other SLR cameras with bottom-mounted winder or power pack, and a lens up to 4" long. It weighs 6 oz. Black color (ZICP) only .....**34.95**



### Zoom SLR Covers

Same basic design as the SLR Camera Covers, but for cameras with longer lenses (up to 7"). Extended flaps wrap around the lens and fasten securely together with Velcro tabs. All Zoom SLR Covers are reversible to black.

#### Standard Zoom SLR Cover:

Fits small SLRs, including most older models. Available in Blue (ZICZBL), Burgundy (ZICZBU), Deep Green (ZICZGR) and Gray (ZICZG) .....**29.95**

#### Large Zoom SLR Cover

Fits an autofocus SLR and other large-body cameras. Available in Blue (ZICLZBL), Deep Green (ZICLZGR) and Gray (ZICLZG) .....**29.95**

#### Pro Zoom SLR Cover

Fits autofocus and other SLR cameras with a bottom-mounted winder or power pack. Available in Black (ZICPZ) .....**34.95**

### SLR Action Covers

Same design and sizing as the Standard and Large SLR Covers, with the addition of a removable elastic waist strap. Used in conjunction with the photographer's own camera neck strap (not included), the waist strap holds the camera tight to the body. Camera can be removed from cover for shooting without having to unfasten waist strap. Ideal for skiing, hiking and other outdoor activities.

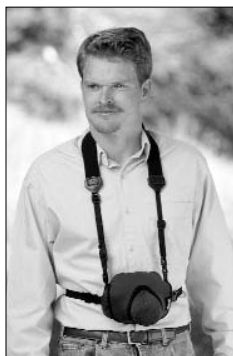

#### Standard SLR Action Cover

Fits smaller SLR cameras, including most older models. It weighs 6 oz. Available in Black (ZICSHB) .....**29.95**

#### Large SLR Action Cover

Fits autofocus SLR and other large-body cameras. It weighs 7 oz. Available in Black (ZICLHB) only .....**29.95**

### Universal Eveready Cases

Two-piece case works just like the classic leather eveready case, with the advantages and contemporary look of neoprene. Case bottom fastens to the camera by running a camera strap (not included) through keeper loops sewn into case interior. Top fastens to bottom with dual thumb-release clips; swings out of the way quickly for shooting, or can be removed completely while case bottom stays on and protects camera body. Velcro tabs allow adjustment to fit different lens/body combinations.



#### Standard Universal Eveready Case

Fits smaller SLR cameras, including most older models, with lens up to 4.5". It weighs 5 oz. Available in Black (ZICUSB) color .....**29.95**

#### Large Universal Eveready Case

Fits autofocus SLR and other large-body cameras with lens up to 4.5" long. It weighs 6 oz. Available in Black (ZICULB) color .....**29.95**



For Any Inquiries Regarding Your Order, Call Our Customer Service:  
(800) 221-5743 • (212) 239-7765 • FAX: (800) 947-2215 • (212) 239-7549

## POUCHES, BAGS & STRAPS

### Drawstring Accessory Pouches

Multi-purpose pouches features color-keyed stretch lycra top hem that allows the drawstring to slide smoothly and cinch tightly. Can be used in a bag for extra padding, worn on a belt with the web loop, or clipped to a bag, strap or belt using the sewn-on plastic snap hook.

#### Small Drawstring Pouch

It's dimensions are 3.75 x 5", and it weighs 3 oz. Black with a choice of Black (ZIPSB), Blue (ZIPSBL) or Purple (ZIPSP) hem.....**9.95**

#### Medium Drawstring Pouch

It's dimensions are 4 x 7", and it weighs 4 oz. Black with a choice of Black (ZIPMB), Blue (ZIPMBL) or Purple (ZIPMP) hem.....**11.95**

#### Large Drawstring Pouch

It's dimensions are 4.5 x 9", and it weighs 5 oz. Black with a choice of Black (ZIPLB), Blue (ZIPSBL) or Purple (ZIPLP) hem.....**13.95**



Small Drawstring Pouch

**Extra Large Protective Stuff Pouch:** The same basic design as Drawstring Pouches, but made of extra-thick neoprene for added cushioning, and sized for substantially higher capacity, such as digital cameras, binoculars, and even medium format cameras. Comes with belt loop and shoulder strap attachments. Black with Navy (ZIPLBL) hem. Dimensions are 6 x 8", weighs 10 oz.....**16.95**



Small Camera Belt Bag

### Camera Belt Bag

A sleek, elegantly simple padded pouch with oversized, Velcro-secured, protective flap and a reinforced belt loop on the back. Holds APS and other point-and-shoot cameras, mini binoculars, cell phones, digital organizers and much more. Belt Bag fashion colors are not reversible.

#### Small Camera Belt Bag

It's dimensions are 3.5 x 5.5 x 1.5", it weighs 2 oz. Available in Black (ZICBSB), Gray (ZICBSG), Burgundy (ZICBSBU) and Blue (ZICBSBL).....**9.95**

#### Medium Camera Belt Bag

It's dimensions are 4 x 6.5 x 1.5", it weighs 2.5 oz. Available in Black (ZICBMB), Gray (ZICBMG), Burgundy (ZICBMBU) and Blue (ZICBMBL) .....**12.95**

#### Large Camera Belt Bag

It's dimensions are 4.5 x 8.25 x 1.5", it weighs 3.5 oz. It is only available in Black (ZICBLB) ...**14.95**

### Deluxe Multi-Strap Camera/Accessory Bag

Horizontal type pouch with an envelope-style flap and Velcro closure. It comes complete with shoulder strap, waist strap, and sewn-on belt loops. Reinforced side panels add protection. Great for cameras, Polaroid and film backs, power packs, small binoculars, personal stereos and more. Colors are not reversible. Dimensions are 5 x 7 x 1.5". It weighs 10 oz. Available in Black (ZIABB), Blue (ZIABBL), Gray (ZIABG), Green (ZIABGR) and Burgundy (ZIABBU) .....**19.95**



Deluxe Multi-Strap Camera/Accessory Bag



#### Standard Camera/Binocular Strap:

Attractive, comfortable and tough camera straps of 5mm thick, 2" wide neoprene. Ample

cushioning and stretch reduce perceived camera weight, with enough density to prevent bouncing. Fully finished edges are trimmed in black binding. Nylon web extensions feature standard camera attachment, durable quick-release hardware and length adjusters. Available in Black (ZISSB) and Deep Green (ZISSGR) .....**12.95**



#### SLR Action "Steady" Strap:

A unique strap that works like the handle-steadying strap found on most camcorders, but is designed specifically for SLR cameras. It wraps around the back of your right hand, holding it snugly to the camera body for fast, steady shooting. The wide contoured neoprene strap provides comfort and security. It attaches to the camera base using included 1/4" -

20 tripod screw, then threads into camera strap slot (camera must have side mounted, slotted strap fitting). Adjustable to fit any size hand. May be used simultaneously with an optional camera neck strap. A "wrist leash" prevents the camera from being dropped accidentally, and a belt clip for hanging the camera between shots. Black color (ZISSLRAB) only. 5 x 7 x 1.5", 10 oz.....**14.95**

# REMIN

## KART-A-BAG

BAGS

622

### Lightweight Carts

Traveling from location to location requires more than carrying your equipment. You probably have some luggage as well. To save injury to your back, shoulders and arm muscles (which can affect your ability to shoot), use telescoping Kart-a-Bag carts.

Constructed of heavy duty aluminum rods and chrome plated automotive grade steel wire, Remin's lightweight carts offer simple load handling (from 100-300 lbs.) and telescoping handles, and most offer the patented locking system which makes opening and closing the carts as easy as pressing a button. Each cart includes a 10-year limited warranty.

#### Flite-Lite 525

Designed to fit into limited cabin storage, Flite-Lite features a patented, push-button locking system with 3" rubber wheels, a recessed, polycarbonate handle with a foam insert for comfort, a raised chrome-plated platform, and chrome-plated steel wheel guards to protect your load. Flite-Lite conforms to airline under-seat storage specifications.

#### Concorde II

The Concorde II features a patented, push-button locking system, a raised chrome-plated solid-steel wire platform, chrome-plated solid-steel wheel guards and curb/stair slides. It has 4" rubber wheels, and a recessed polycarbonate handle with a foam insert for comfort, and conforms to airline under-seat storage specifications.

#### Concorde III

The same as the Concorde II but with larger 5" roller bearing, rubber wheels.

#### Concorde V

Similar to Concorde III, the Concorde V features a tubular polybicycbonate handle, 5" roller bearing rubber wheels, and an adjustable lock on the permanently attached elastic cords to prevent load shifting.

#### Super 600

Similar to the Concorde V, the Super 600 has 6" roller bearing semi-pneumatic wheels.

#### Tri-Kart 750

The same as the Concorde V with the addition of a patented rear platform with swivel casters that folds down into a locked position to function as a 4 wheel dolly.

#### Tri-Kart 800

The same as the Super 600 with the addition of a patented rear platform with 3" swivel casters that folds down into a locked position to function as a 4 wheel dolly.

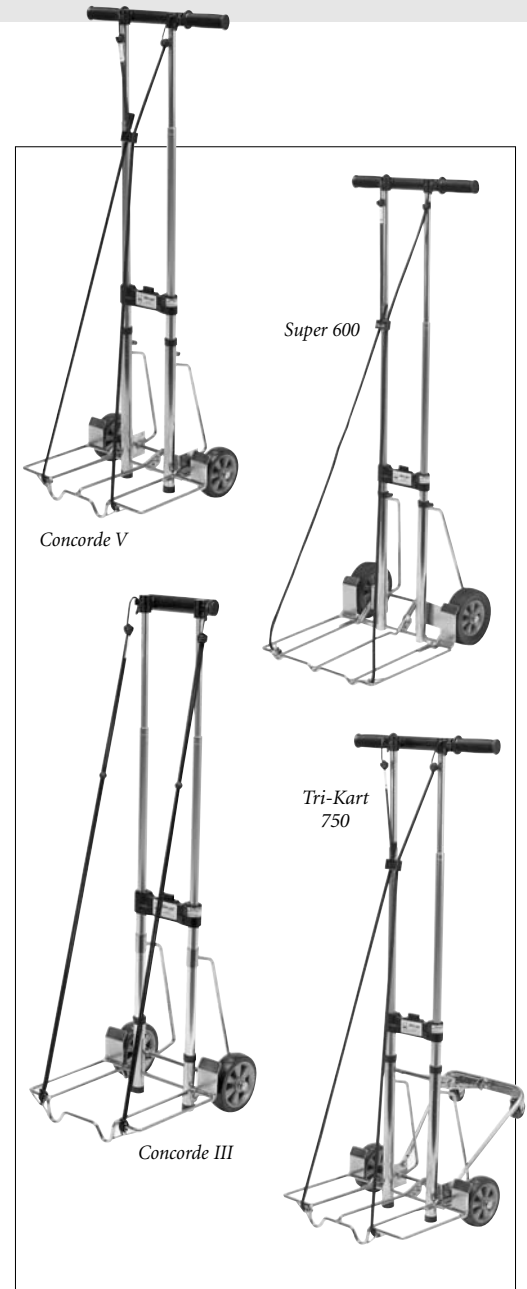

### REMIN CARTS SPECIFICATIONS

| Model                  | Construction                         | Wheels            | Opened Height | Closed          | Base       | Load Capacity | Weight   | Price  |
|------------------------|--------------------------------------|-------------------|---------------|-----------------|------------|---------------|----------|--------|
| Flite-Lite (REFLC52)   | Steel                                | 3" Rubber         | 40"           | 18½ x 11½ x 3¼" | 7½ x 8½"   | 100 lbs.      | 4 lbs.   | 62.95  |
| Concorde II (REC2)     | Steel                                | 4" Rubber         | 41"           | 18½ x 13½ x 4½" | 9.5 x 11½" | 150 lbs.      | 5 lbs.   | 64.95  |
| Concorde III (REC3)    | Steel                                | 5" Rubber         | 41"           | 18½ x 13 x 4½"  | 9½ x 11½"  | 175 lbs.      | 7½ lbs.  | 69.95  |
| Concorde V (REC5)      | Steel                                | 5" Rubber         | 45½"          | 21½ x 15½ x 5½" | 9 x 15½"   | 225 lbs.      | 10½ lbs. | 94.95  |
| Super 600 (RES600)     | Steel                                | 6" semi-pneumatic | 48"           | 20½ x 16 x 7"   | 15½ x 12½" | 300 lbs.      | 13 lbs.  | 109.95 |
| Tri-Kart 750 (RETK750) | Same as Concorde V, with rear wheels |                   |               |                 |            |               |          | 134.95 |
| Tri-Kart 800 (RETK800) | Same as Super 600, with rear wheels  |                   |               |                 |            |               |          | 142.95 |



EQUIPMENT LEASING AVAILABLE



# RUXXAC

## FOLDING CARTS

Save time and effort with these lightweight, reliable hand carts. Ruxxac's folding carts are the perfect solution for toting a variety of audio and video equipment, computers, convention and presentation materials, heavy suitcases and any other heavy loads.

The Standard and XL models carry up to 275 lbs., yet fold to 2½". A heavy-duty tie-down 60" elastic cord helps secure items. Cast aluminum 19" wide nose plate and powder-coated steel frame ensure life long dependability. Large 7¼" shock absorbent rubber tires make maneuvering up stairs and curbs easier. Shipped assembled, unfolds in seconds, ready to use. Includes a lifetime limited warranty.

The Jumbo model has a 550 lb. capacity, yet is only 5" thick when folded flat. It ships assembled, ready for use in seconds. Solidly constructed of a combination of steel tube/aluminum and glass-fiber reinforced plastics, it weighs only 28 lbs. A sturdy 22" wide and 13" deep noseplate lets you handle bulky and awkwardly shaped items. Pneumatic tires with lug treads, running on roller bearings, provides exceptional rolling comfort on a variety of surfaces.

**Folding Cart Standard (RUC):** 27 x 20 x 2.5", it weighs 11.5 lbs. and carries 275 lbs.....**99.95**

**Folding Cart Extra Long (RUCXL):** 29.5 x 20 x 2.5, it weighs 12 lbs. and carries 275 lbs .....**109.95**

**Folding Cart Jumbo (RUCJF):** 49.75 x 22.5 x 5", it weighs 28 lbs. and carries 550 lbs.....**299.95**



BAGS

623

## CLIPPER CARTS

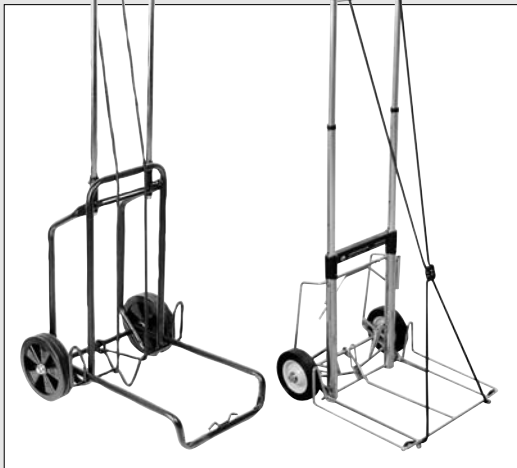

Clipper hand carts save time, energy, space, and your back. The Clipper 82-2E and 90-2E can haul 180 lbs. and 250 lbs. (respectively) of equipment on their black steel tubular base. They feature single motion, squeeze handle release and self-locking base. Sturdy parallel stair glides ease the load while climbing steps and street curbs. Guards in front of wheels protect soft cases.

The Clipper 94E can haul up to 250 lbs. of equipment on its base. Its rear wheels fold up flush to the cart for easy storage. A press of the foot raises and lowers the rear wheels — no more bending. Lower tray and front wheels keep loads from tipping. Four wheels are better than two for load capacity and stability.

The Clipper 660-2 carries up to 300 lbs of equipment on its chrome plated all steel base. It features a single-motion, squeeze-handle release, telescoping tubes and self-locking base. The recessed handle is wide enough for two hands. Stair glides ease the load while climbing steps and street curbs.

The Super Cart 770-3 is a heavy duty telescoping cart that can be used as is, or upgraded with unique click-n-go attachments for specialized applications. It weighs only 16 pounds yet it has a 400 pound capacity. It features a sturdy parallel stair glides, has unique safety loop securing cords and a load tray that accom-

modates a wide range of sizes and shapes. A single-motion squeeze-handle telescopes the cart closed for space-saving storage and portability.

The Super Cart 880-3 is the combination of the 770-3 and a unique click-n-go rear wheel assembly that stabilizes loads and takes the weight off your arms and back. It weighs only 20 lbs. yet it can carry up to 400 lb. It has spring locks on the rear wheel brakes. The rear wheels fold up flush to the cart for easy storage. No tools are required to install or remove rear wheel assembly.

| Model                  | Construction | Wheels       | Opened Height | Closed           | Base        | Load Capacity | Weight  | Price         |
|------------------------|--------------|--------------|---------------|------------------|-------------|---------------|---------|---------------|
| <b>82-2E</b> (CL822E)  | Steel        | Ball-Bearing | 39"           | 22.5 x 13 x 6"   | 10.5 x 11"  | 180 lbs.      | 10 lbs. | <b>42.95</b>  |
| <b>90-2E</b> (CL902E)  | Steel        | 4"           | 41.5"         | 25.5 x 17.5 x 7" | 14.25 x 16" | 250 lbs.      | 13 lbs. | <b>59.95</b>  |
| <b>94-E</b> (CL94E)    | Steel        | Rubber       | 43"           | 25 x 17.5 x 7"   | 14.5 x 14"  | 250 lbs.      | 15 lbs. | <b>69.95</b>  |
| <b>660-2</b> (CL6602)  | Steel        | Ball-Bearing | 47"           | 22 x 16 x 6.5"   | 16.25 x 13" | 300 lbs.      | 13 lbs. | <b>99.95</b>  |
| <b>770-3</b> (CL7703)  | Steel        | Rubber       | 47"           | 25 x 16.5 x 6.5" | 16 x 13.5"  | 400 lbs.      | 16 lbs. | <b>109.95</b> |
| <b>880-3</b> (CL8803E) | Steel        | —            | 50"           | 25 x 16.5 x 6.5" | 16.25 x 13" | 400 lbs.      | 20 lbs. | <b>139.95</b> |

ORDER & INFO. (212) 502-6340 • FAX: (212) 239-7770 (800) 947-7008  
**1-800-290-6750 • www.bhphotovideo.com**



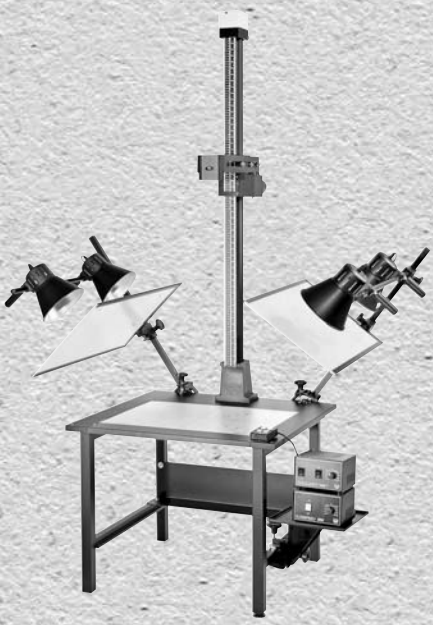



# The 35mm SLR Photo

SourceBook

## Section 7

### Copy Stands and General Accessories

|                           |         |
|---------------------------|---------|
| Bencher .....             | 626     |
| Beseler .....             | 627     |
| Bogen.....                | 628-629 |
| Kaiser.....               | 630-633 |
| Testrite.....             | 634-635 |
| General Accessories ..... | 635-643 |

# BENCHER

## COPYMATE II

COPY STANDS

626

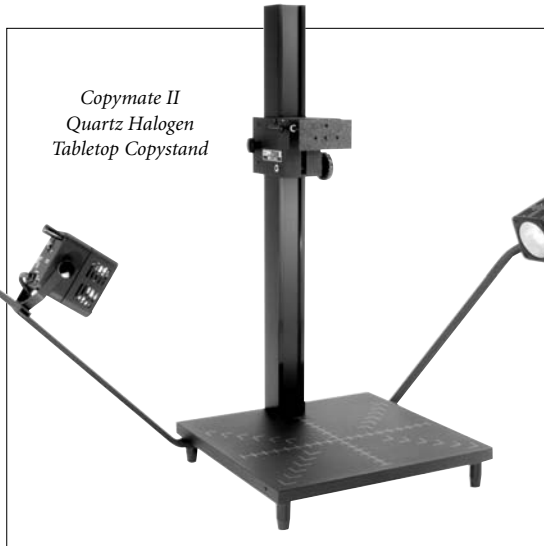

Copymate II  
Quartz Halogen  
Tabletop Copystand

### Tabletop Copy Stand

The Copymate II is a versatile system ideal for anyone using 35mm or lightweight video cameras weighing up to 5 lbs. The basic version of the user-friendly Copymate II includes a rigid 3' aluminum column and a 16 x 20" gray laminate baseboard with a complete grid for easy copy positioning. The optional lights and light arms mount at the rear of the baseboard to allow easy copying of oversized originals. A unique dual brake locking system eliminates lateral carriage shift assuring precise positioning of the camera carriage. The camera carriage features two machined steel shafts with a 3.5" front-to-back travel which allow easy centering of the camera lens over the baseboard. Column and carriage come with mounting bolts and washer plate. A full range of accessories is available for the Copymate II including quartz halogen (3200K) or fluorescent (5000K) lighting, light

baffles, polarizing filters, and book and copy hold-down easels. An optional light intensity control is available for quartz lighting to reduce heat, energy expense and increasing lamp life.

#### **Copymate II Tabletop Copystand** (BECM2TT)

Consists of a center column, carriage and baseboard only. Doesn't include any lights. Weighs 29 lbs.....**389.95**

#### **Copymate II Quartz Halogen Tabletop Copystand** (BECM2Q)

Same as above plus sidelight arms and two 300-watt quartz halogen copy lights. Weighs 36 lbs .....**624.95**

#### **Copymate II Quartz Halogen Tabletop Copystand with Heavy Duty Spring** (BECM2QWHDS)

Same as above except it incorporates a factory-installed heavy-duty counter-balance spring that allows the carriage to hold cameras weighing up to 8 lbs. Weighs 41 lbs.....**674.95**

#### **Copymate II Tabletop Producer** (BECM2PQ)

Same as BECM2Q plus it incorporates a dimmer switch to lower light output for focusing and composing. Reduces heat, energy expense and increases lamp life. Weighs 38 lbs.....**724.95**

#### **Copymate II Quartz Halogen Tabletop Producer with Heavy Duty Spring** (BECM2PWHDS)

Same as above except it incorporates a factory-installed heavy-duty counter-balance spring that allows the carriage to hold cameras weighing up to 8 lbs. Weighs 41 lbs.....**782.95**

#### **Copymate II Fluorescent Tabletop Producer** (BECM2PF)

Complete copystand with high frequency fluorescent lights and light arms, one each side. Ideal for digital imaging and specimen photography these cool full spectrum fluorescent lamps are daylight balanced at 5000K for superb color clarity and operate at 12,000Hz to eliminate flickering in video applications. Free standing light control has on/off main switch and on/off switch for left lamp to permit shadowing on raised, embossed or bas-relief subject matter. Total 72-watt output equivalent to approximately 200-watts of incandescent lighting. Weighs 33 lbs .....**854.95**

#### **Copymate II Fluorescent Tabletop Producer with Heavy Duty Spring** (BECM2PFWHDS)

Same as above except it incorporates a factory-installed heavy-duty counter-balance spring that allows the carriage to hold cameras weighing up to 8 lbs. Weighs 33 lbs.....**854.95**

#### **Book Hold-Down for Copymate II** (BEBHDCM2)

A special easel designed to hold books open for photography or A/V use. Protects valuable books by putting only the weight of the sheet against the pages and binding. Foam rubber blocks support the thinner open side of the book, gently holding the pages against the glass. The book holder clamps to the baseboard. Glass working area: 16 x 13.5" (WxD). Accepts materials to 3.5" thick.....**199.50**

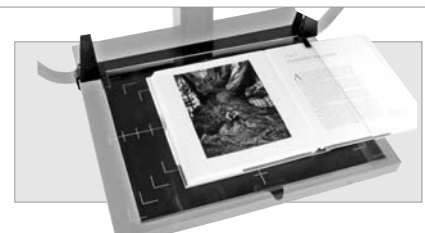

**EQUIPMENT LEASING AVAILABLE**

# BESELER

## CS-14

### Copy Stand

The CS-14 Copy Stand offers reliable Beseler performance, an 18% gray baseboard with grid and magnetic copy hold-down bars, and a unique, adjustable camera platform that facilitates the precise alignment of the optical axis of the camera over the exact center of the baseboard. Copy positioning is aided by multiple positioning grids, format patterns and reference scales on the baseboard. The camera moves on a single, straight vertical column, aided by a constant force, counterbalanced elevation system. The turn of a knob locks the camera in position at the desired height. The column is anchored to the 16 x 19" baseboard at four points and accepts any camera up to 5 lbs. Maximum recommended copy size is 14 x 14".



- ◆ Accepts a wide range of camera systems
- ◆ A uniquely adjustable camera platform facilitates the precise alignment of the optical axis of the camera over the exact center of the baseboard. (Positioning grids on the 18% grey baseboard aids in alignment).

- ◆ Options, like the Beseler CLA copylight arms with industry standard 3/8" mounting studs accept almost any lighting system.
- ◆ Four lights can be mounted onto the universal 3/8" studs which are positioned for the best illumination control

- ◆ Additional calibrations and controls are available to enhance operation and output
- ◆ Magnetic holddown bars locate the copy and keep it flat and in place

CS-14 Copy Stand (BECS14).....214.95

COPY STANDS

627

### Copystand Kits for the CS-14 or CS Digital/Photo-Video

Consists of copystand, CLA light arms (BECLA), set of two CL-600 copy lights (BECL600) and two R50 5" reflectors (BER5CL). The arms are supplied with four positionable universal light mounting brackets with 3/8" mounting stud for CL-600 lights. Economical and convenient, the CL-600 copy lights are ready-to-use tungsten lamps that provide illumination for all copy work needs. Can be used with standard or reflector lamps up to 600 watts. The R50 reflector is made of hand spun anodized aluminum, chemically etched to maximize light output.

CS-14 Copystand Kit (BECS14K) .....454.95    Digital/Photo-Video Copystand Kit (BECSDPVK) .....569.95



### CS Digital/Photo-Video Copy Stand

The CS Digital/Photo-Video Copy Stand has an updated counterbalance and is suitable for cameras weighing up to 16 lbs. The stand emulates the rigid twin E-channel centerbraced column so popular in the 45V-XL enlarger chassis design. A rack and pinion elevation system positions your still, digital or video camera where it can be easily locked into position. Three axis, lateral adjustments and alignments are easily made using the camera platform bracket. The 44" tall column is securely mounted to a 22 x 28" baseboard. Maximum recommended copy is 20 x 20".

- ◆ Heavy duty copy stand for multiple applications including photo, video and digital use

- ◆ Rack and pinion elevation system
- ◆ Three axis, lateral adjustments

CS Digital/Photo-Video Copy Stand (BECSDPV).....419.95

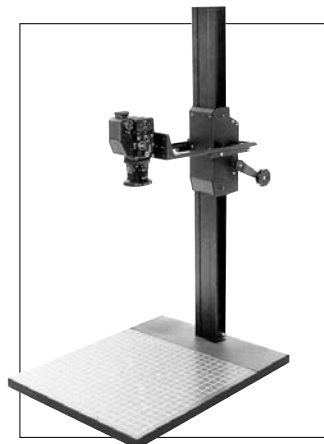

ORDER & INFO. (212) 502-6340 • FAX: (212) 239-7770 (800) 947-7008  
1-800-290-6750 • www.bhphotovideo.com



# BOGEN

## REPRO COPY STANDS

COPY STANDS

628

For photographers who are seeking solidly-built, full-featured copystands, Bogen offers a full line of versatile, precision-made items. Available in configurations to meet every copy need, the Repro line can accommodate still and video cameras in all formats and weights. For rock-solid performance, see the System 800 lineup, which is built for steady, heavy-use performance for the busiest copy studio. Photographers with budgetary constraints or low traffic copy work may want to consider the Mini Repro. No matter what your needs, however, there is a Bogen copystand that is right for you.

### Mini Repro Copystands

#### Mini Repro (BO1700)

This easy-to-use, economical copystand is suitable for video and still cameras up to medium format and is ideally suited for macro photography and day-to-day copy work. The Mini Repro features a ruled black anodized column that is geared for precise camera positioning. Grid marks on the baseboard help you position and align the original artwork. The column height is 27.5", the base is 15.5 x 16.5", and it weighs 15 lbs.....**184.95**



Mini Repro Copystand

#### Mini Repro (BO1704)

Same as above Mini Repro, but with 4-light assembly. Weighs 20 lbs.....**299.95**

### Super Repro Copystands

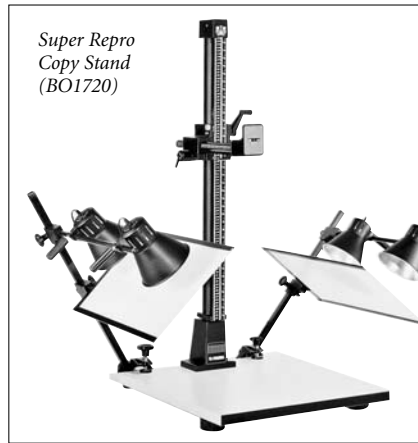

Super Repro Copy Stand (BO1720)

#### Super Repro Copy Stand with Baseboard (BO1730)

This solidly-built copy stand offers loads of features, including a counter-balanced, ruled and 53" geared column; a camera arm that is geared for precise front to back centering and a camera leveling guide built into the camera platform. A geared accessory arm offers side-to-side movement, that lets you create animation effects similar to those done on more expensive animation stands. The overall height is 57.5"; the maximum height is 48"; and the minimum height is 7.5". Camera arm adjustment from column is 3-19". The baseboard measures 27.5 x 35.5". It weighs 67 lbs .....**699.95**

#### Super Repro Copy Stand with Baseboard (BO1720)

Featuring the same impressive range of features as the above Super Repro, but with a 43" column. The overall height is 47.5", the maximum elevation is 38", and the minimum elevation is 7.5". The camera arm is adjustable 3-19" from the column. The baseboard is 24 x 26.5". Weighs 50 lbs .....**679.95**

#### Super Repro Copy Stand with Baseboard (BO1723)

A Super Repro with a 43" column and a 27.5 x 35.5" baseboard. Weighs 67 lbs.....**729.95**

#### Super Repro Copystand with Table and Light Box (BOFF1738)

The Super Repro Copy Stand with table and light box. It weighs 117 lbs.....**1709.95**

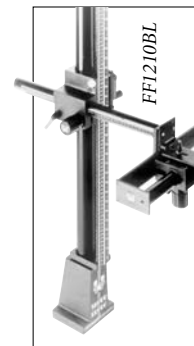

#### Super Repro Column (BOFF1210BL)

43" column only (without baseboard). It weighs 26 lbs .....**629.95**

#### Super Repro Column (BOFF1220BL)

53" column only (without baseboard). Weighs 26 lbs .....**629.95**

## Repro Copystands

#### Repro Copy Stand with Baseboard (BO1710)

The Repro features a sturdy geared and ruled column that is suitable for both still and video cameras and can be rotated to copy artwork that is larger than the baseboard. Horizontal camera arm length is adjustable in four equal increments. Maximum height is 41"; column height is 46"; minimum height is 7.5". Camera arm is adjustable 4-12" from column. The baseboard is 24 x 26.5". Weight: 40 lbs .....**459.95**

#### Repro Copy Stand with Baseboard (BO1713)

Same as the above Repro Copy Stand, but with 27.5 x 35.5" baseboard. Weighs 57 lbs .....**489.95**

#### Repro Center Column (BOFF1200BL)

Repro column only, without baseboard. Weight: 16 lbs .....**381.95**





# BOGEN

## SYSTEM 800 COPY STAND

### System 800 Repro Copy Stand (BOFF1740)

A motorized copystand for professional reproduction of transparencies and reflective originals. The column is mounted on a rock-solid 31.5 x 27.5" table with a magnetic baseboard. The ball-bearing horizontal support arm mount, which can be adjusted for the optimum optical center, will accommodate any camera up to 8x10 format, or any video camera that weighs up to 44 lbs. The camera is raised and lowered via a variable-speed motor drive. Lights, light boxes, barndoors and hinged glass accessories are available for this state-of-the-art stand. Maximum height is 82.8", column height 59" and base 27.5 x 31.5". Weighs 114.5 lbs.....**2876.95**

### System 800 Repro Copy Stand (BOFF1741)

Same as the above System 800, but outfitted with a light box instead of a magnetic baseboard. Weighs 155 lbs.....**3229.95**

System 800 shown with a Four Light Assembly



System 800 shown with Repro System Lights, Diffusion Panels, and a Varilight 2000 Power Supply

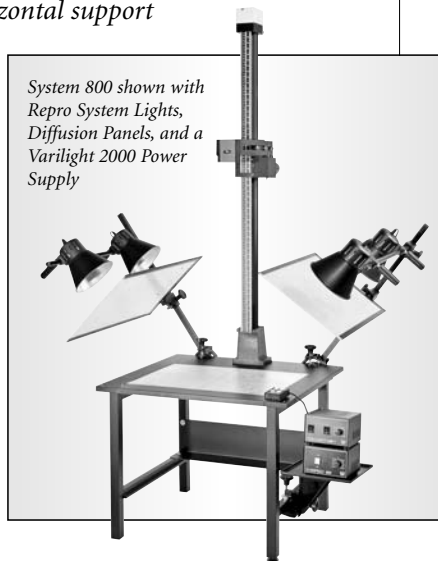

COPY STANDS

629

## COPY STAND ACCESSORIES

### 4-Light Lighting Assembly (BO1705)

Four Tungsten Reflector Heads in lighting assembly. Fits the Mini Repro Stand. Weighs 5 lbs.....**119.95**

### Fixed Barndoors (FF1196)

Set of 4 fixed barndoors for the Mini Repro Lights.....**29.95**

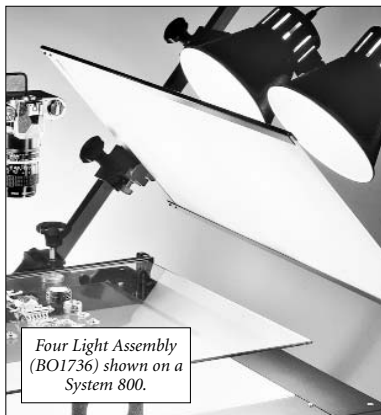

Four Light Assembly (BO1736) shown on a System 800.

### Lighting Assembly (BO1735)

Comes with two Tungsten Reflector Heads and fits all Repro Copy Stands. It includes medium screw base sockets and accepts BBA (No. 1 Photoflood) lamps. 16 lbs.....**279.95**

### Four Light Assembly (BO1736)

Same as the above Lighting Assembly, but with 4 light heads. For all Repro Copy Stands. Weighs 17 lbs.....**419.95**

### E27 Base Quartz Lamp 250w (BO1737)

Medium base lamp, 3200°K.....**56.95**

### Varilight 2000

#### Power Supply (BOFF1223T115)

For regulating Lightbox intensity on the Super Repro Copy Stand (BOFF1738) and System 800 (BOFF1741).....**234.50**

### Barndoors for all

#### Reflector Heads (BOFF1777)

Set of 2 barndoors.....**74.95**

### Diffusion Panels (BOFF1225)

Set of 2. For all Repro Lighting Assemblies.....**207.95**

### Utility Tray with Clamp (BOFF2357)

For the tables on the Super Repro Copy Stand and System 800.....**136.50**

### Gear Side Arm (BOFF1227)

Provides precise positioning of the camera on Repro Copy Stands.....**179.95**

### Lightbox for System 800 (BOFF1222Y115)

Included with the System 800 (BOFF1741).....**366.95**

### Hinged Copy Glass (BOFF1229)

For the tables on the Super Repro Copy Stand (BOFF1738), and System 800 (BOFF1740) and (BOFF1741).....**222.50**

### Magnetic Baseboard Plate (BOFF1389)

Dimensions are 16½ x 25". For Repro Copy Stands. It is included with System 800 (BOFF1740).....**74.50**

ORDER & INFO. (212) 502-6340 • FAX: (212) 239-7770 (800) 947-7008  
**1-800-290-6750 • www.bhphotovideo.com**





# KAISER

## COPY STANDS

COPY STANDS

630

### R1 Universal Flexible Modular System

Kaiser stands consist of a column, a baseboard, a camera arm and a light set. Kaiser allows you to create you own stand by selecting the different components, or by purchasing a complete stand (less lights). This offers you the greatest freedom in assembling the perfect stand for your needs. And it ensures that your stand will grow as your needs expand.

#### COLUMNS

Wide and extremely vibration-resistant column of embossed aluminum tubing with dull-black anodized surface, with *cm* and *inch* scales. With mount and fastening mechanism for copy arms. Cross sectional dimensions of the column are 2.8 x 1.4".

##### 60" Calibrated

**Counter Balanced Column (KACSC60)**  
Height adjusted by friction gear with nylon bearings, weight compensated by built-in roll spring.....**321.95**

##### 50" Calibrated

**Counter Balanced Geared Column (KACSC50)**  
Height adjusted by gear rack, weight compensated by built-in roll spring, locking screw for fixed height position .....**414.95**

##### 40" Calibrated

**Counter Balanced Column (KACSC40)**  
Height adjusted by friction gear with nylon bearings, weight compensated by built-in roll spring.....**247.95**

##### 40" Two Speed Calibrated

**Counter Balanced Column (KACSC402)**  
Rack-and-pinion height adjustment by hand crank. Additional fine drive with 1:10 step-down transmission for super-fine adjustment. Counterbalance by built-in roll spring.....**601.95**

#### BASEBOARDS

Copy baseboard with a mounting base for attaching column. Spirit level in base. Individually height-adjustable feet.

**23 x 31.5" Grid Baseboard (KABB2331.5) ..218.95**

**20 x 24" Grid Baseboard (KABB2024).....182.95**

**18 x 20" Grid Baseboard (KABB1820).....169.95**

**25 x 22" Illuminated Baseboard (KAIBB2225)**  
With a 17 x 14" illuminated area. It is equipped with four 13 watt daylight fluorescent lights (5400 K) and high frequency operating system .....**1249.50**

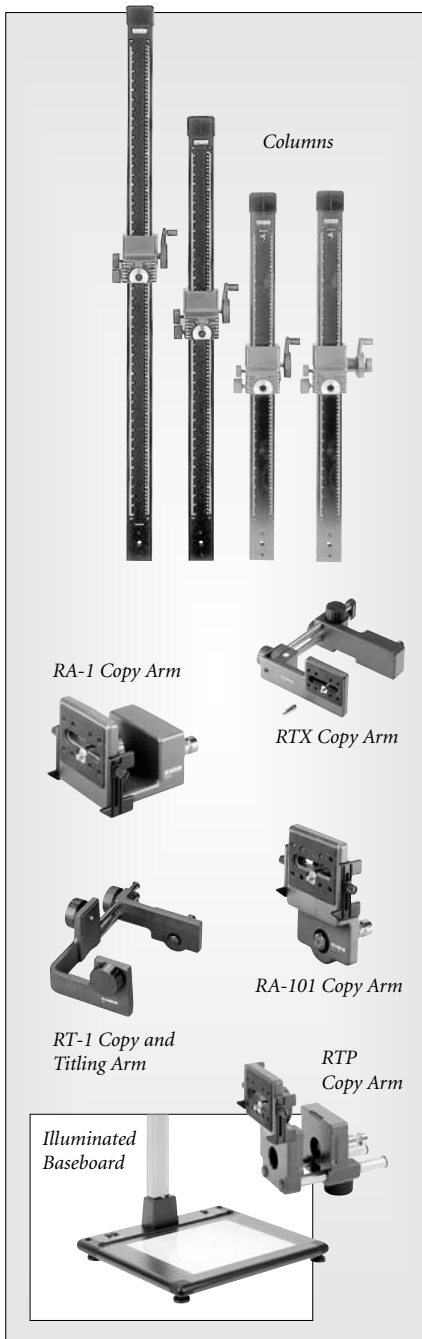

#### CAMERA ARMS

##### RTX Copy Arm (KACARTX)

The RTX extends from 3.75 to 9.06" via a rack drive. Camera mount with level for fine adjustment. Turns  $\pm 180^\circ$  and can be fixed in any position. The camera can be mounted on front or rear. Camera mount horizontally adjustable with fine adjustment. The RTX has an interchangeable 1/4" - 3/8" mounting thread .....**489.95**

##### RA-1 Copy Arm (KACARA1)

4" deep camera arm. This device for adjusting the camera can be set to different camera bodies. Interchangeable 1/4" - 3/8" mounting thread.....**104.50**

##### RA-101 Copy Arm (KACARA101)

The RA-101 Copy Arm is 1.2" deep, and is suitable for cameras with a large distance between the tripod thread and the optical axis of the lens. Interchangeable 1/4" - 3/8" mounting thread. Adjusts for different camera bodies .....**94.95**

##### RT-1 Copy and Tilting Arm (KACART1)

The RT-1 Copy and Tilting Arm extends from 6.5 to 10". Camera mounting platforms for horizontal and upright formats with interchangeable 1/4" - 3/8" threaded bush and rubber rests. Camera carrier extends horizontally, on parallel arms, and can be locked in any position. The entire copy and tilting arms rotate to allow for reproduction of vertical subjects .....**208.50**

##### RA-3 Copy Adapter (KACARA3)

For converting a VP-350 Enlarger to a copy unit. With 1/4" connecting thread. Dimensions are 2.4 x 3.7 x 3.3" .....**39.50**

##### RTP Copy Arm (KACARTP)

The RTP Copy Arm is horizontally adjustable to set different distances from the column. It moves 3.2" back and forth and rotates 360°. Guided in parallel. The camera adjusting device can be set to different camera bodies. Reversible mounting thread.....**239.95**



For Any Inquiries Regarding Your Order, Call Our Customer Service:  
(800) 221-5743 • (212) 239-7765 • FAX: (800) 947-2215 • (212) 239-7549

# KAISER

## COPY STANDS

COPY STANDS

631



### Repro Kid Copy Stand Kit

A super-compact copy stand for small and lightweight cameras (APS, digital compacts, CCD cameras etc.). It includes a non-reflecting 12.6 x 15" matte black baseboard, a 23.2" calibrated column that incorporates a manually height-adjustable camera arm and a lighting unit with two screw-in sockets for photofloods up to 250 watts each (lamps not included). It has a load capacity of 2.2 lbs.

ReproKid Copy Stand Kit (KACSKK) .....216.95

### COPY STANDS WITH 29" COLUMN

#### RS2 Copy Stand (KACRS2)

Designed for lighter camera systems, the RS2 Copy Stand comes with a 15.7 x 19.7" non-reflecting, black baseboard with grid markings, and a 30" column with *cm* and *inch* scales. A repro arm with 1/4" mounting screw holds many lighter cameras .....289.95

#### Copy Light Mounting Arms (KACLA)

A pair of mounting arms for the RS2 Copy Stand. The arms are adjustable in height and tilt and can be equipped with Copy Light Sockets.....199.95

#### Copy Light Sockets (KACLS)

For use with the Copy Light Mounting Arms. It comes with two cords (6.5' each) with a cord switch. It requires two 250w lamps, which are not included .....57.95

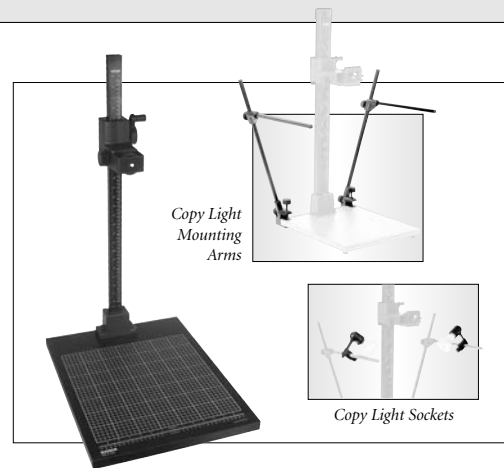

### COPY STANDS WITH 40" COUNTER-BALANCED COLUMN

#### RS1 Copy Stand (KACRS1RA1)

This high-quality copy stand features a non-reflecting 17.7 x 19.7" matte black baseboard with grid surface marking, an extra-wide, vibration-resistant 39.4" dull black anodized embossed aluminum tube column with *cm* and *inch* scales, and a spirit-level in the column base. The height is adjusted by a friction drive with nylon bearings and hand crank. A 4" deep RA1 Copy Arm for different camera bodies .....394.95

#### RS1 Copy Stand (KACRS1RT1)

Same as the above RS1, but with an RT1 Copy Arm which has two camera fastening points and interchangeable threaded bush 1/4", 3/8". The camera carrier pivots and slides horizontally.....524.95

#### RS10 Copy Stand (KACRS10)

Similar to the RS1 Copy Stands, the RS10 features a 39" column, a 23.6 x 19.7" baseboard and an adjustable copy arm which moves 3.1" back and forth.....832.95

#### Copylizer "eVision exe.cutive" (KACSCe)

A complete reflected/transmitted light/stand combination, for capturing originals of all kinds, including three-dimensional objects. The 25 x 22" baseboard has an illuminated area of 16.9 x 13.8", and is fitted with four 13w daylight fluorescent lamps (5000 K). The low-vibration column is 40" high and is equipped with the RTP adjustable camera arm.....1449.50

### COPY STAND WITH 50" COUNTER-BALANCED COLUMN

#### RSX Copy Stand (KACRSX)

Big non-reflecting matte black baseplate embossed with grid and *cm* scale. The RSX features height adjustable feet, a spirit-level in the column base, a low-vibration 4" anodized aluminum tube column with *cm* and *inch* scales, a 23.6 x 19.7" baseplate and an RTX copy arm with an adjustable and pivotable camera holder .....859.95

All 40" and 50" Copy Stands work with any Lighting Sets on the next page.

ORDER & INFO. (212) 502-6340 • FAX: (212) 239-7770 (800) 947-7008  
1-800-290-6750 • www.bhphotovideo.com



# KAISER

## COPY STANDS

COPY STANDS

632

### REPRO COPY STAND SYSTEM

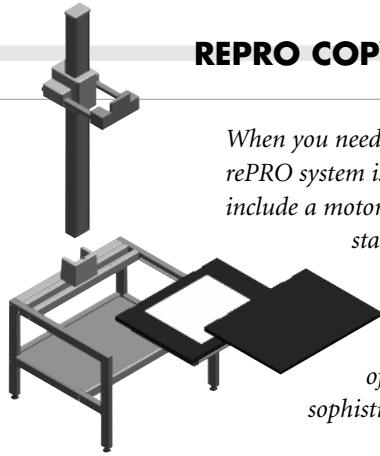

*When you need maximum stability and load capacity, the rePRO system is the choice for you. System components include a motorized 60" column, a baseboard, or a floor stand that can be equipped with a large drop-in base plate for reflective originals, and lighting units. This professional work station – equipped with a camera system of your choice – offers optimum conditions for sophisticated image capturing tasks.*

#### RSP 60" Motorized Column

with Camera Carrier (KACSCRSP)

This rePRO stand is for professional use. The black anodized aluminum column has both *cm* and *inch* scales. The camera carrier offers remote controlled two-speed motorized height adjustment, with constant speed, independent of the camera weight. The self-inhibiting spindle drive holds the camera platform precisely at any height, even during a power failure. Horizontal adjustment is with parallel guides via a manual friction drive. Adjustment crank and locking screw on the left and right sides. A spirit level is built-in for adjustment to parallel axis setting. The camera mounting plate tilts  $\pm 90^\circ$ , and can be locked on two sides .....**3638.95**

#### Floor Stand for RSP Column (205615)

A steel tube stand with an integrated spirit level, a die-cast aluminum base for mounting the RSP Motorized Column, and a shelf underneath the working area. The feet can be height-adjusted individually. Its dimensions are 34.6 x 26 x 30.7" .....**809.95**

#### Baseboard for RSP Floor Stand (205616)

Non-reflecting, plastic-laminated, high-compressed wooden 32 x 24" baseboard, with a fine grid and *cm/inch* scales. It includes a slide-in carrier for the optional lighting unit control box.....**346.95**

#### Wall Mount for RSP Column (KABWMRP)

For the RSP Motorized Column. The top section is adjustable for vertical positioning. The lower part has a base, spirit level and a power supply compartment. The column is 14" from the wall, the camera mounting plate is 20-29" from the wall. ....**519.95**

#### RB 5056 HF Lighting Unit (KACLRB5005)

A lighting unit with two light banks, each equipped with two 5400K daylight fluorescent lamps. High frequency operating system for non-flicker start-up and running. Lights can be tilted and shifted individually. The switch box can be mounted below the base board.....**1869.95**

#### RB 5005 Flash Lighting Unit (KACLRB5005F)

Combined flash/continuous light unit with two light banks, each fitted with one flash lamp and two daylight fluorescent lamps. Flash unit with automatic flash discharge, power control, flash ready display, synchro and manual triggering. Continuous light can be used for set-up and shooting purposes independently from flash light. Electronic high frequency operating system for flicker-free lighting.....**4699.95**

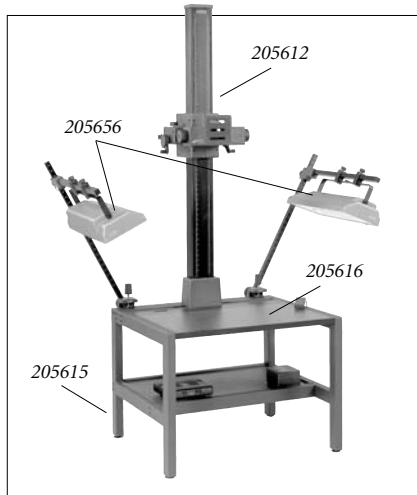

## ACCESSORIES



#### Table Frame (KACST)

For the RS1, R10 and RSX camera stands. Height-adjustable feet. Slide-in compartment for copy light control box. 22.8 x 23.6 x 20.1" .....**482.50**



#### BASEBOARD OVERLAYS

For the Copylizer "eVision executive" and the 25 x 22" Illuminated Baseboard. They can be fitted to the hinge of the base plate and easily lifted.

#### Hinged Glass Overlay (KAOLGCEVE)

Pressure plate made of high quality crystal glass with adjustable stop guides.....**188.95**

#### Metal Base (KAOLGMCEVE)

Neutral gray (18% reflection) protective cover with printed grid and adjustable stop for easy positioning. Four round magnets hold the original.....**179.50**

#### Masking Frame (KAOLMFCEVE)

With adjustable masks to prevent stray light when capturing smaller transparent originals from 35mm up to 4 x 5" ...**238.50**



EQUIPMENT LEASING AVAILABLE

## LIGHTING SETS FOR COPY STANDS

### Copy Light Mounting Arms (KACLA)

A pair of mounting arms for the RS2 Copy Stand. The arms are adjustable in height and tilt and can be equipped with Copy Light Sockets.....**199.95**

### Copy Light Sockets (KACLS)

For use with the Copy Light Mounting Arms. It comes with two cords (6.5' each) with a cord switch. It requires two 250w lamps, which are not included .....**57.95**

### RB104 Lighting Unit (KACLRB104)

Supplied with four reflectors and E 27 screw-in threads for photofloods. Lamps (up to 250 watts each) can be tilted and switched on separately. Unit clamps to base boards and tabletops up to 1.8" thick. Cords are 8'. Lamps not included .....**736.95**

### RB2 Copy Light Set (KACLRB2)

With four tiltable and adjustable reflectors on mounting arms which are in turn tiltable and adjustable in height. For lamps up to 150 watts each, that can be switched on individually. It clamps onto base boards up to 1.8". Two cords are 5" each. Lamps not included .....**439.95**

### RB300 Copy Light Set (KACLRB300)

The RB300 Copy Light Set comes complete with two 300 watt halogen lights. Lights can be shifted, swiveled, and switched on and off separately. Clamps fasten to baseboards or tabletops up to 1.8" .....**453.95**

### RB5000 DL Lighting Unit (KACLRB5000Q)

Lighting unit with two light banks, each equipped with a 36w daylight-type (5400 K) compact fluorescent lamp. Lamps can be switched on and off individually.....**793.50**

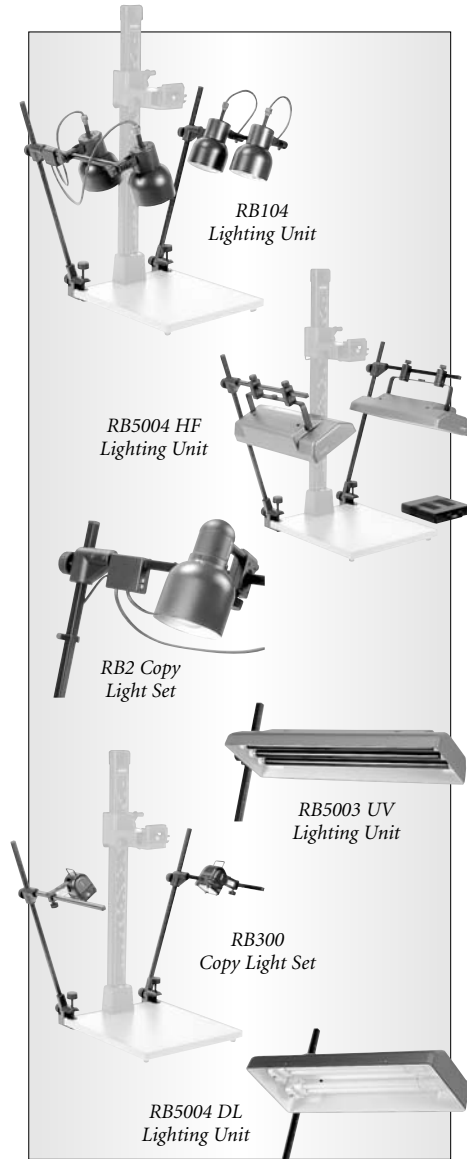

### RB5004 HF Lighting Unit (KACLRB5004HF)

Lighting unit with two light banks each equipped with two 36 watt (5400 K) daylight fluorescent lamps. Electronic high frequency operating system for non-flicker start-up and running. Lights can be switched on and off and tilted individually.....**1253.95**

### RB218 HF Lighting Unit (KACLRB218HF)

Two reflectors, tilting and adjustable in height, with one 18 watt Dulux (5400 K) fluorescent lamp each. High-frequency operating system. Separate control box .....**793.50**

### RB5003 UV Lighting Unit (KACLRB5003)

UV lighting unit with two light banks, each equipped with three 18 watt UV(A) fluorescent lamps. For special applications in conjunction with inspection of materials, detection and documentation of falsification etc. Special Order .....**1638.95**

### RB 4-36 Copylizer Lighting Unit (KALSRB4.36)

For Copylizer "eVision exe.cutive". Each side light has two 36 watt daylight fluorescent lamps, and are attached at the base. Both reflectors are adjustable in height and can be swiveled individually. The size of the lamps match the base plate, to help achieve even illumination.....**1298.95**

### RB 4-36 HF Copylizer Lighting Unit

(KALSRB4.36Q)

Same as above except with a high frequency operating system that delivers flicker-free light .....**1364.95**

### RB 8-36 HF Copylizer Lighting Unit

(KALSRB8.36)

Same as the RB 4-36 (above), except that each side light has four 36 watt daylight fluorescent lamps .....**2459.95**

### TO MAKE A STAND...

| To Make This Stand: | RS1 Copy Stand (KACRS1RA1) | RS1 Copy Stand (KACRS1RT1) | RS10 Copy Stand (205513) | RSX Copy Stand (KACRSX) | Copylizer "eVision exe.cutive" (KACSC) |
|---------------------|----------------------------|----------------------------|--------------------------|-------------------------|--|
| <b>You Need:</b>    |                            |                            |                          |                         |  |
| <b>Column</b>       | KACSC40                    | KACSC40                    | KACSC40                  | KACSC50                 | KACSC40                                |
| <b>Baseboard</b>    | KABB1820                   | KABB1820                   | KABB2024                 | KABB2024                | KAIBB2225                              |
| <b>Copy Arm</b>     | KACARA1                    | KACART1                    | KACARTP                  | KACARTX                 | KACARTP                                |

# TESTRITE

## COPY STANDS

COPY STANDS

634

*These economical copystands are particularly suitable for students, amateurs and pro operators that wish to add copying capabilities. All cameras from 35mm to 4x5 will fit. Also ideal for Polaroid and video use.*

### **CS-1 Copy Stand** (TECS1)

The basic model. Handles small 35mm still cameras and camcorders. It comes with a 14 x 19" baseboard and a 23" steel column. Lights additional .....**52.50**

### **CS-1 Copy Stand with Lights** (TECS1L)

A CS-1 Copy Stand with a two-light unit that attaches to the baseboard. It comes complete with cord sets, sockets, swivels, aluminum reflectors and wood control knobs .....**77.95**

### **CS-2 Copy Stand** (TECS2)

Sturdy model features a 16 x 19" baseboard and two interlocking 19" posts which reach 38" altogether. Sliding arm moves smoothly through entire length of dual post .....**67.50**

### **CS-2 Copy Stand with Lights** (TECS223C)

A CS-2 Copy Stand, packed with a lighting unit, which includes two 12" chrome-plated flexible arms, two sockets with individual on-off switches and two metal reflectors .....**113.95**

### **CS-3 Copy Stand** (TECS3)

Features two interlocking 1.5" diameter, 19" long posts which reach 38" altogether. Camera bracket permits centering of camera over original. Post locking feature allows travel of arm up and down entire length of posts .....**89.95**

### **CS-3 Copy Stand with Lights** (TECS32344)

A CS-3 Stand packed with a 16 x 22 3/4" baseboard and a light unit that has 4 aluminum reflectors .....**135.95**

### **CS-4 Copy Stand** (TECS4)

Features heavy-duty, rigid parallel construction, 3" longer than CS3 arm, 2 interlocking 1.5" diameter 19" long posts which reach 38" altogether. Post locking feature allows travel of arm up and down entire length of posts. Extra-long camera bracket with large lock-up washer permits easy centering over work. Accommodates all copy lights .....**121.95**

### **CS-5 Copy Stand** (TECS5)

Especially designed for schools, hospitals and pro photographers who require a sturdy, heavy duty copier. Features include: one-piece 2" diameter 34" long chrome plated steel post; a sturdy 20 x 30" baseboard that can accommodate 16 x 20" originals horizontally or vertically; a counterbalance spring that easily supports heavy 4x5 cameras; heavy-duty sliding arm that moves easily up and down post; extra large 6" long camera rod which permits centering over original; sturdy struts from baseboard to top of counterbalance that eliminate vibrations. Will accommodate all copy lights .....**183.95**

### **CS-7 Mini Copy Stand** (TECS7)

Portable all-aluminum and steel unit features angled legs that can be easily disassembled for storage or travel. 18" steel post holds camera rod that can be set horizontally for copying or vertically for use as a table-top stand. Unit can be placed on glass and shot through for special effects. 23c or 23P copy lights are suitable for this model .....**45.95**

### **CS-9 Heavy Duty Stand** (TECS9)

The CS-9 has a 36" post that includes inch and centimeter scales. It offers a heavy-duty sliding counterbalanced arm that offers unique squareness adjustment. Wood baseboard offers 20 x 30" workspace with grayscale covering for even illumination verification over the entire board. Camera rod and lock-up knob extends to 3". Height can be adjusted from 7.5 - 36.5" .....**121.95**

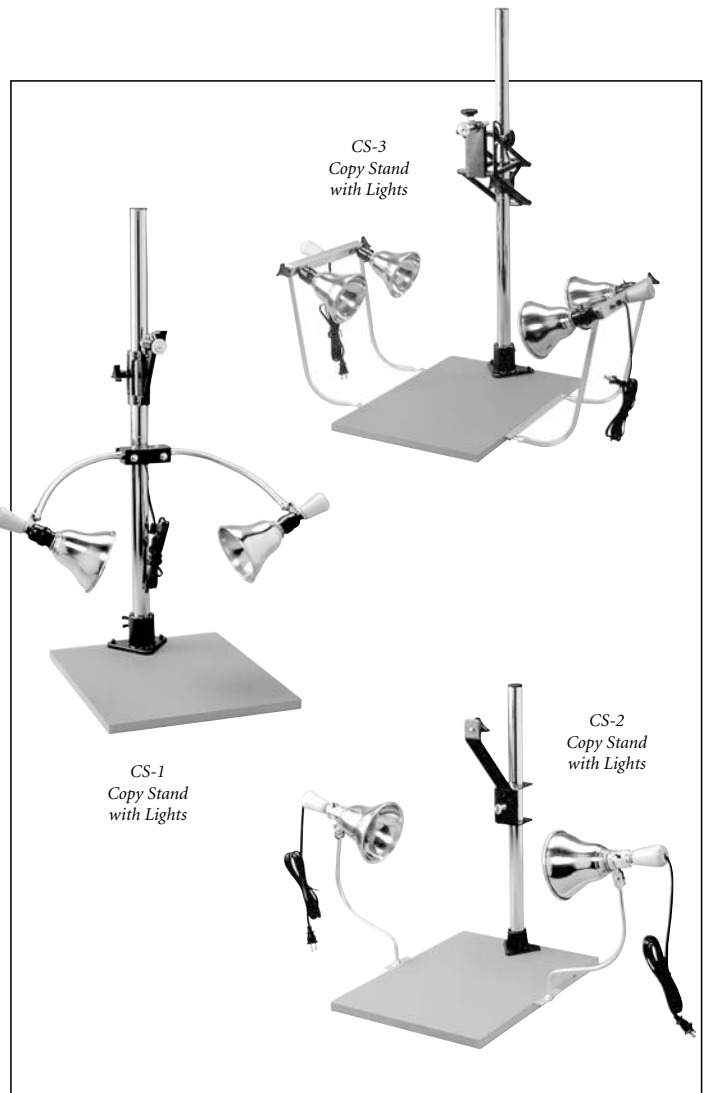

## Copy Lights

Copy lights should be at a 45° angle to the work be copied. Use regular household 75w bulbs if the unit has reflectors for color copying with daylight color film (5500°K), use an 80A and an 82A filter on your camera. With tungsten color film (3200°K), use an 82A filter.

### 23-C Copy Lights (TECL23C)

Designed to fit in any post from 1/2"-1.5". Clamp arrangement makes it simple to raise and lower light on post. Features two 12" chrome-plated flexible arms, sockets with individual on-off switches, bell-shaped metal reflectors and cool handling wood knobs. Bulbs not included. Weighs 4.5 lbs....55.95

### 23-P Copy Lights (TECL23P)

Similar to model 23-C, but with porcelain sockets to accommodate high-wattage reflector type bulbs. Aluminum reflectors cannot be used on these sockets. Weighs 4 lbs...46.95

### 23-4 Copy Lights (TECL2344)

Used with copy stands, four lights provide even illumination when copying larger originals. Unit is fastened to sides of baseboard by screws. Safety knob permits "cool and easy" adjustment. Includes 4 aluminum reflectors. Weighs 6 lbs .....74.95

### 45 Photo & Copy Lights (TECLA5)

Designed to do both studio and copy work, these lights can be set to 45° for copy work or swiveled almost horizontal to board for skin or texture lighting effects. Can be raised almost to vertical. Attaches to any wood baseboard. Comes complete with two swivels, four sockets that slide on 1/2" aluminum tubing, and four aluminum reflectors. Weighs 10 lbs .....99.95

### 50 Copy Lights (TECL50)

Extremely adjustable in all directions. Features four ceramic sockets that accept all standard screw-base bulbs up to 250w. Adjustable for 3-dimensional or flat objects-use to photograph objects as well as for copy work. Use with CS-4, CS-5 and CS-9 copy stands. (Note: Aluminum reflectors cannot be used in these ceramic sockets.).....98.95

## EXPOSURE GUIDES

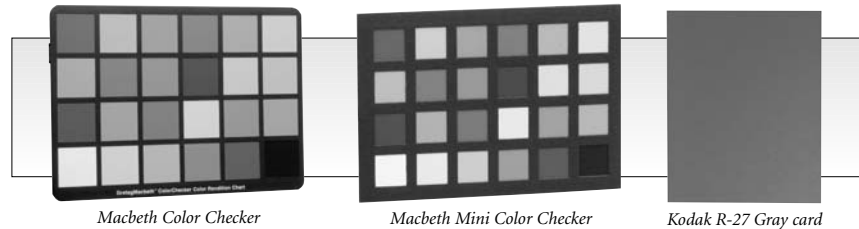

### Gretag Macbeth Color Checkers

An array of 24 printed color squares, which include spectral simulations of light and dark skin, foliage, etc. It is used for precise color balance when shooting color film. Scientifically engineered to ensure true-to-life images, they are designed to help you recognize, evaluate and adjust colors quickly and efficiently. 9:13 proportions will fill a 35mm frame.

**Color Checker** 8 x 11.5" #GRCC.....66.95    **Mini Color Checker** 2.25 x 3.25" #GRMCC .59.95

### Kodak R-27 Gray Card

Helps determine exposure, adjust lighting ratio, and check lighting distribution. Gray side, 18% reflectance; white side, 90% reflectance. Envelope contains two 8 x 10" cards and a 4 x 5" card.

**Kodak R-27 Gray Card** with instructions in English #KOGC.....14.95

**Kodak R-27 Gray Card** w/instructions in English, Spanish, French & German #KOGCQ.....14.95

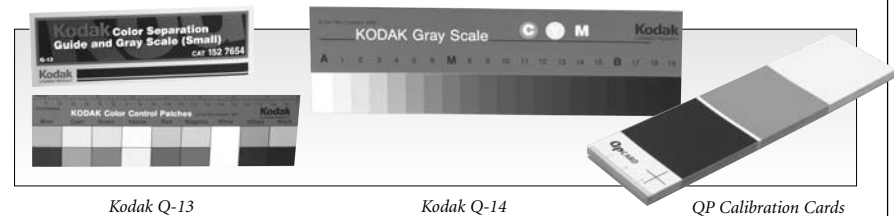

### Kodak Color Separation Guide and Gray Scale

Available with a small 8.5" (Q-13) or large 14" (Q-14) gray scale and color control patches, these cards are for copy work, side-by-side comparisons of films, enlarging papers and color reproduction processes that require the use of masks, separation films and filters. Useful for photographers utilizing the Zone system.

The gray scale is a strip of 20 stepped, neutral values and an 18% gray background that will help compare tone values of the original with the reproduced image. The color control patches are for photos that are used in offset printing. Contains standard separation colors used in RGB and CMYK processes, that helps match the color in the reproduction to the original.

**Small (Q-13) #KOCSCS** .....18.50    **Large (Q-14) #KOCGL** .....23.50

### QP Calibration Card 101 (Pack of 15 Cards)

A small, lightweight and inexpensive way to calibrate your contrast. A pad of 15 QP cards comes in a protective resealable foil bag that easily fits into a camera case or pocket. The cards have an adhesive back. The grey surface is completely neutral and reflects 18% light. A white and black patch can be used for contrast adjustment. In addition, the card can be used as a dimensional reference.

**QP Calibration Card 101 (Pack of 15 Cards) #QPC101** .....19.95

# GENERAL ACCESSORIES

## DUST REMOVERS

GENERAL ACCESSORIES

636

### DUST REMOVING BRUSHES

#### Delta Camel Hair Brush

The photo standard for 50 years, the Delta Camel Hair Brush is perfect for cleaning your optics, lenses and other photographic equipment. It's safe, ultra soft, and it will last for years.

1" Camel Hair Brush (DEBCH1) .....11.95    2" Camel Hair Brush (DEBCH2) .....13.95

#### Kinetronics StaticWisk Lens Brushes

The Kinetronics StaticWisk is a fine quality anti-static lens brush. It is made from a special blend of soft, natural hair and a conductive fiber. To use the brush, simply "sweep" the lens. The brush has a resistivity of 10-1 and will dissipate any static charge and "release" the dust. Their natural hair and conductive fibers are assembled with stainless steel wire, and may be washed in shampoo and water to clean or vacuumed to remove dust. Brushes are available in 3/4" to 4" widths.

Mini StaticWisk (KIMW) 3/4" wide.....6.95    30 StaticWisk (KIB1) 1.25" wide .....12.99  
60 StaticWisk (KIB2.5) 2-1/2" wide .....19.95    100N StaticWisk (KIB4) 4" wide .....21.95



Kinetronics 100N



Kinetronics 30



Kinetronics Mini

### LENS PENS



Bushnell Lens Cleaning Pen



Hakuba MiniPro LensPen



Hakuba LensPen

#### Bushnell Lens Cleaning Pen (BUAK)

A 2-in-1 lens cleaning system featuring a high-quality, soft, retractable lens brush and self-replenishing flexible tip that won't scratch or damage lenses. The remarkable cleaning compound removes fingerprints, smudges and grease marks without spilling and it won't dry out. Safe for all lenses, including multi-coated surfaces. Use with camera lenses, binoculars, camcorders, etc. Environmentally friendly, non-toxic.

Includes a neoprene strap, lens cleaner and cleaning cloth .....10.95

#### Hakuba LensPen

Winner of PTN's product of the year award for five years in a row, there is simply no cleaning tool as effective and easy to use for cleaning camera lenses, binoculars, scopes and other optical equipment. The LensPen's unique cleaning technology outperforms the most advanced microfiber cloths by getting into the nooks and crannies, leaving a sparkling shine over 100% of the lens surface.

LensPen #HAPLC.....9.95    MiniPRO #HAPLCMPQ.....9.95

### BLOWER BRUSHES

#### Rubber Blower Brushes

Rubber bulb type with protective sleeve. Helps clean lint and dirt from negatives and camera parts without scratching or smudging.

Small #GBBBS .....3.50    Medium #GBBBM.....3.95    Large #GBBBL .....4.95

#### Medium Size Rubber Blower Brush (GBBB)

With sliding tube and protective cap to cover brush when not in use.....5.95

#### Giottos Rocket Air Blowers

Made from a silica gel, they are very powerful and refill quickly. They are made of a non-toxic, environmentally friendly material, resistant to both high and low temperatures, tear-proof. It has an air valve to prevent it from breathing in dust and blows out a powerful stream of air to blow dust away, to make cleaning lenses, cameras, filters a breeze. Unique rocket-shaped design allows the blower to stand upright, and its removable nozzle can be removed and stowed. Includes a neck strap.

Rocket Air Blaster 6.6" long (GIBAS) .....8.95    Rocket Air Blaster 7.5" long (GIBA).....9.95

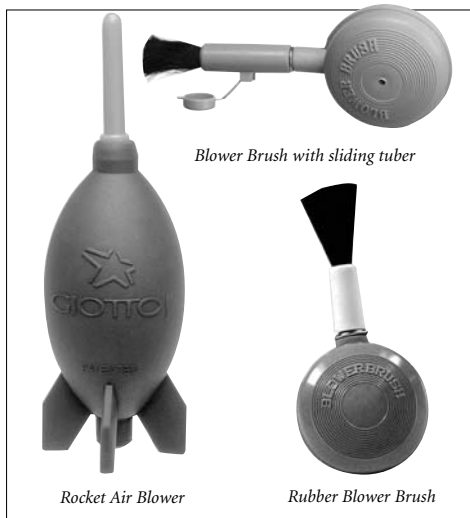

Blower Brush with sliding tuber

Rocket Air Blower

Rubber Blower Brush



For Any Inquiries Regarding Your Order, Call Our Customer Service:  
(800) 221-5743 • (212) 239-7765 • FAX: (800) 947-2215 • (212) 239-7549



# GENERAL ACCESSORIES

## CLEANING CLOTHS

### BLOWERS & BLOWER BRUSHES

#### Hakuba Blowers & Blower Brushes

Made from natural rubber for easy handling and pinpoint accuracy, these blowers and blow brushes remove lint and dust from hard to reach places. Essential for cameras and optics, they are also ideal for maintaining computer, audio and other electronic equipment.

- Hurricane Blower (5¼ x 2") #HABHQ.....5.95
- Super Blower Medium (5½ x 2") #HABSM .....6.50
- Super Blower Large (6 x 2½") #HABSL .....8.50
- Brush Deluxe Small (3¾ x 1¼ x 1¼") #HABBS .....4.95
- Blower Brush Deluxe Medium (4¾ x 2¼ x 1-½") #HABBM .....5.50
- Blower Brush Deluxe Large (5" x 2½ x 1¾") #HABBL .....6.50

#### Kaiser Blower Brushes

Blower brushes take up little space, and are the all-purpose and gentle method for removing loosely deposited dust and fluff.

- Flat Brush with large rubber blower bulb (KABBF) .....9.95
- Round Brush with large rubber blower bulb (KABBR) .....9.95
- Lens Brush in plastic tube with lipstick twist mechanism (KABLS) ....9.95



### CLEANING CLOTHS

#### Clearsight Micro-Fiber Lens Cleaning Cloth (CLLC)

Made of 20% polyamide and 80% polyester, this cleaning cloth is thin, with the look and soft feel of non-lip suede to assure a firm grip and good cleaning control. They are also totally lintless. Washable, the cloth measures a generous 8 x 8".....4.95

#### Leland PowerClean Cloths

Super soft synthetic micro fiber cloth, the environmentally responsible PowerClean cloths replace disposable paper wipes which are often chemically saturated. Micro fiber technology is superior to natural fibers due to its design. When made into a cloth, it can absorb twice its weight in water, does not require oil to stay soft and doesn't shrink after laundering. Contamination, dirt, and even finger oil, is safely and effectively wiped clean from a variety of coated and non-coated optical surfaces, including CD's, lasers, lenses, and even eyeglasses.

- 6.5 x 6.5" MiniCloth #LEMC.....4.95
- 11 x 12" UltraCloth #LEUC .....7.95

#### Spudz Micro Fiber Cleaning Cloth

a small micro fiber cleaning cloth that is perfect for photographers, birders, and any one who needs to clean their optics in the field, it has a convenient pouch and hook design that allows you to attach, and keep the cloth where you want. Available in four colors: Black, Blue, Cameo, and Rainbow.

- Micro Fiber Cloth-Black #SPSPB.....4.95
- Micro Fiber Cloth-Blue #SPSPBL.....4.95
- Micro Fiber Cloth-Cameo #SPSPC .....4.95
- Micro Fiber Cloth-Rainbow #SPSPRB ..4.95

#### Hakuba SuperKnit

Hakuba's SuperKnit is a microfiber cloth designed to remove not only dust and lint but also difficult to clean smudges and oil based spots. Uses no chemicals and will not scratch or mark polished surfaces. Washable and reusable, it offers superior cleaning power for the care of digital, and traditional cameras and lenses.

- Small (6.3 x 7.8") #HACCSS .....4.95
- Medium (9.5 x 11.8") #HACCSM .....7.95

GENERAL ACCESSORIES  
637

# GENERAL ACCESSORIES

## CLEANING TOOLS

### CLOTHS & WIPES



#### Hakuba UltraKnit Polishing/Cleaning Cloth

Hakuba's UltraKnit polishing and cleaning cloth offers superior cleaning power for the care of digital, and traditional cameras and lenses. It is also perfect for cleaning all types of CDs, TV screens, computer monitors, jewelry, crystal and most other polished surfaces. Washable and reusable.

Small (7.5" x 7.5") #HACCUS.....9.50  
 Medium (11.8" x 11.8") #HACCUM .....13.50

#### Falcon Dust-Off Luminex Cleaning Cloth (FALC)

Falcon's Luminex cleaning cloth (7½ x 7½") is the high-tech way to clean any type lens or filter. More effective than lens tissue or any other cleaning cloth due to its 220,000 microfibers per square inch, it easily lifts away dirt, grease and dust. 100% lint-free, they are washable and reusable .....5.95

#### Premier Photo Wipes (PRPW)

Lint free, non-abrasive, super soft, super strong, both wet or dry, and highly absorbent professional 13" x 17" photo wipes. Photo wipes offer countless uses that save time, money, equipment. They can clean lenses, glass negative carriers, and scanners, without fear of scratching.

Each box contains 50 wipes .....4.95

#### Kodak Lens Cleaning Paper (KOLT)

Soft, absorbent paper that is safe for use on the finest lenses, Kodak's lens cleaning paper is lint-free and chemically pure. Contains 50 3 x 5" sheets .....1.95

### FALCON DUST-OFF

Falcon Dust-Off delivers the most comprehensive line of dust-removing and preventive maintenance cleaning products for your electronics and other household items. Dust-Off products are not flammable and completely safe for normal use, but they do contain some flammable elements. They are also 100% ozone-safe.



#### Dust-Off Plus Kit (FADOPKQ)

The innovative Vector Valve rotates 360° with a 180° vertical orientation. Provides amazing range and versatility. One-of-a-kind nozzle allows you to keep duster upright while delivering a cleaning blast to difficult-to-reach areas. 100% ozone safe. Dust-off Plus is a nozzle plus replacement canister system. When canister is empty just save the nozzle and replace the canister.

Includes 10oz. refill can .....26.95

Dust-Off Plus 10 oz. refill #FARDOP8 .....7.09

360° Vector Valve (Repl.) #FAVDOP .....19.95

#### Dust-Off Classic

##### with Chrome Valve (FADOK)

The one that started it all more than 20 years ago. A true classic. Provides more pressure per blast than disposable dusters. Chrome valve provides years of dependable use. Designed for the consummate professional. 100% ozone safe.

Optional refills are available.....22.95

10 oz. Chrome-Valve Classic Refill #FARDO...6.99

Chrome Valve (Replacement) #FAVDO .....19.50

#### Dust-Off Jumbo (17 oz.) (FADOJQ)

The newest and most economical duster delivers more cleaning power per can. Designed for larger cleaning applications and frequent users. Plenty of value per ounce. Same efficient blasting power as other disposable products. 100% ozone safe .....7.95

#### Dust-Off Mini (1.75 oz.) (FADOM)

The small can that packs a powerful punch. Designed to travel. Handy, palm-sized duster conveniently fits in laptop or camera bags. 100% ozone safe .....2.95

#### Dust-Off JR (3.5 oz.) (FADOJ)

Compact. Disposable. Indispensable for places where space is tight. The flexible plastic tube can be set in any direction to make hard to reach spots easy to reach. Perfect for computer labs, camera bags, tool kits, desktops, and darkrooms. Same efficient blasting power as larger models. 100% ozone safe .....3.95

#### Dust-Off X-Large (10 oz.) (FADOD)

Falcon's most commonly-used duster, the Dust-Off X-Large provides superb blasting power. Larger-size disposable can gives you a great value. Ideal for workstations, labs, repair benches, household use, on-location photography, etc. Provides potent dust-removing power for practically any task. 100% ozone safe .....7.50



For Any Inquiries Regarding Your Order, Call Our Customer Service:  
 (800) 221-5743 • (212) 239-7765 • FAX: (800) 947-2215 • (212) 239-7549

# GENERAL ACCESSORIES

## CLEANING TOOLS

### BESELER DUST-OFF

Beseler canned air is an economical general purpose air for cleaning equipment, optics, negatives, and any other hard to reach spots where dust may accrue. Beseler's dust guns provide dry, ultra-filtered air to remove even microscopic dust and lint from your negatives, slides and photo or electronic equipment. 100% ozone-safe, non-flammable and contains no ether! More environmentally safe than ever before—meets all federal regulations regarding duster products.



**Dust Gun 100 Disposable 2.5 oz. Can** (BEDG1002.5): With built-in continuously-variable trigger valve and extension nozzle. The perfect size for your camera bag, when you're out in the field.....**4.24**

**Dust Gun 100 Disposable 8 oz. Can** (BEDG1008): With built-in trigger valve and extension nozzle .....**6.24**

**Dust Gun 100 8 oz. Refill Can** (BERDG1008): Requires universal chrome trigger valve...**5.75**

**Dust Gun 100 Disposable 12 oz. Can** (BEDG10012): With built-in continuously-variable trigger valve and extension nozzle.....**7.95**

**Dust Gun 100 12 oz. Refill Can** (BERDG10012): Requires chrome trigger valve.....**7.24**

**Dust Gun 100 Refill Cans** (BERDG100812): 12 Pack - 8 oz.....**62.50**

**Duster 12 oz. Disposable** (BED12): With built-in air-directing nozzle.....**6.25**

**Duster 8 oz. Disposable** (BED8): With built-in air-directing nozzle .....**4.95**

**Super Dust Gun 100 Disposable 12 oz. Can** (BESDG10012): With a built-in high powered, continuously-variable trigger valve and an extension nozzle .....**8.24**

**Universal Chrome Trigger Valve** (BETV): For Dust Gun 100 Refills.....**19.95**

**Hama Self-Timer 1** (HAST): 10 second timer. Plunger travel is adjustable to between 0.12" and 0.315". With stop button. Supplied in a case.....**43.50**

**Hama Film-Safe X** (HAFSX): Protection for up to four rolls of 35mm film. Hard shell case protects film against x-rays up to ISO 3200 as well as dust, splashing water and sun.....**12.95**

### LENS CLEANING KITS

#### Giottos Lens Cleaning Kit (GILCS)

One of the best ways to care for your lenses and equipment, this kit includes a retractable soft brush, pack of 10 pointed tip cotton swaps, micro-fiber cleaning cloth and bottle of lens cleaner..**8.95**



#### Giottos Lens Cleaning Kit with Small Rocket Blaster (GILCK)

One of the best ways to care for your lenses and equipment, this kit includes Giottos' small Rocket Air Blaster, retractable soft brush, pack of 10 pointed tip cotton swaps, micro-fiber cleaning cloth and bottle of lens cleaner .....**16.95**



#### Hakuba Lens Cleaning Kit (HALCK)

The Hakuba Lens Cleaning Kit comes complete with 30 sheets of lint free lens cleaning paper, along with 30cc of optical safe lens cleaning liquid .....**3.95**



#### Hakuba Lens Cleaning Set (HALCS)

The Hakuba Lens Cleaning Set comes complete with 30 sheets of lint free lens cleaning paper, along with 30cc of optical safe lens cleaning liquid, a bulb type blower Brush, and a soft cleaning cloth.....**4.50**



GENERAL ACCESSORIES

639

# GENERAL ACCESSORIES

## CLEANING PRODUCTS

GENERAL ACCESSORIES

640

### LENS CLEANING KITS



#### **Kinetronics Optics First Aid Kit (KIOFAK)**

Like an insurance policy for quality images, the Kinetronics Optics First Aid Kit is a must have whether you're on safari, on tour, or in the field. Ideal for cameras, camcorders, binoculars, scopes, rangefinders and instruments, the kit includes Precision Cleaning Solution for lenses and viewfinders, Tiger Cloth Anti-Static Microfiber Cleaning Cloth, StaticWisk SW-020 Anti-Static Lens Brush and SpeckGRABBER for removing specks from lenses.....19.95

#### **Zeiss Lens Cleaning Kit (ZELCK)**

Includes 2 strips of pre-moistened cloths, 1oz. spray cleaner, a microfiber lens cloth, lens care card and durable carrying bag .....24.95



#### **Zeiss Pre Moistened Lens Cloths (ZECT)**

The ultimate in convenience, these pre-moistened, non-abrasive lens cloths safely and quickly clean any lens. High-tech ammonia-free formula cleans effectively without leaving streaks or residue. Clean smudged and dirty lenses at your convenience with these handy individual packets. Pack of 20.....6.95



### LENS CLEANING SOLUTIONS

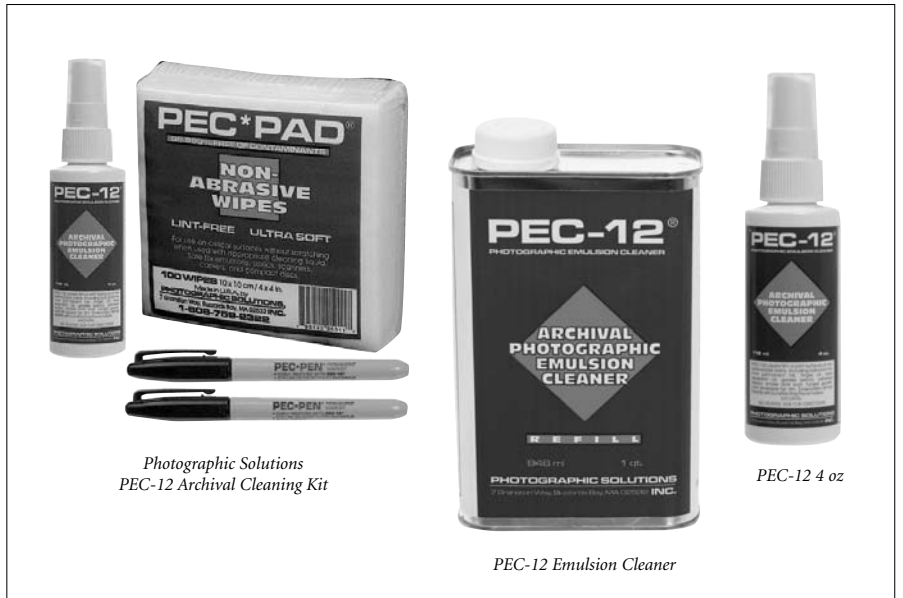

Photographic Solutions  
PEC-12 Archival Cleaning Kit

PEC-12 Emulsion Cleaner

PEC-12 4 oz

#### **Photographic Solutions Eclipse Lens Cleaning Kit (PHEOCS)**

Eclipse lens cleaner is the highest purity lens cleaner available. It dries as quickly as it can be applied leaving absolutely no residue. When used with the 4 x 4" PECPAD photo wipes it is possible to clean only the portion of lens which is dirty eliminating "hazy swirls". Includes 2 oz. bottle of Eclipse Lens Cleaner with dropper applicator and 10 photo wipes .....7.50

#### **Photographic Solutions PEC-12 Photo Emulsion Cleaner**

PEC-12 is a non-water based film and print cleaner which removes virtually all non-water based stains from color and black & white slides, negatives, and prints. It removes grease pencil, adhesive residue, finger oils, ball-point pen, fungus, smoke and soot damage, laser separation oil and most permanent inks. Pump-spray bottle with no water, PEC-12 dries instantly with no emulsion swelling and leaves no residue

**PEC-12 Photo Emulsion Cleaner**  
4 oz. bottle #PHP124.....9.95

**PEC-12 Photo Emulsion Cleaner**  
32 oz. bottle #PHRP12Q.....46.95

#### **Photographic Solutions PEC-12 Archival Cleaning Kit (PHP12K)**

A great tool for any studio, darkroom, film crew, photographer, or anyone who needs to be organized. The kit consists of the famous PEC-12 emulsion cleaner, Pec Pads, and two Pec Pens that washes off easily using the Pec cleaner and pads.....16.95

#### **ROR Residual Oil Remover (ROR20)**

Residual Oil Remover is a lens cleaner that aims specifically to remove micro-carbon residue which is present on the surface of a lens. Although invisible to the naked eye, when removed from the lens it provides a remarkable change and a significant light entry increase (up to 3/4 of an f-stop, in most cases). 2 oz spray bottle....6.95



For Any Inquiries Regarding Your Order, Call Our Customer Service:  
(800) 221-5743 • (212) 239-7765 • FAX: (800) 947-2215 • (212) 239-7549

# GENERAL ACCESSORIES

## STAMP KITS/PADS/BATTERY TESTERS

### RUBBER STAMP KITS

#### Rexton

##### Rubber Stamp Kit for "Proof" (RERSPK)

Convenient assembly includes everything needed to make fast drying non-smudging rubber stamp images on valuable photographic work. Allows the photographer to place a message on proof prints to help prevent unauthorized copying. Refill quantities are available.



\$18<sup>95</sup>

##### Kit contains:

- 4-oz. each of Rexton Pro-Black Series-3 Ink and Rextonol Solvent/Remover/Rejuvenator
- 1 'PROOF' rubber stamp
- 1-uninked premium-grade felt 2.75 x 4.25" stamp pad

##### Rubber Stamp Kit for "Preview" (RERSPKQ)



\$18<sup>95</sup>

##### Kit contains

- 4-oz. each of Rexton Pro-Black Series-3 Ink and Rextonol Solvent/Remover/Rejuvenator
- 1 'PREVIEW' rubber stamp
- 1-uninked premium-grade felt 2.75 x 4.25" stamp pad

##### Rubber Stamp Kit "Do Not Copy" (RERSDNCK)

##### Kit contains

Includes: 4 oz. ea. Rexton Pro-Black Series-3 Ink and Rextonol Solvent/Remover/Rejuvenator, 1 Proof or Preview rubber stamp, 1 un-inked felt #1 size stamp pad, 2 zipper lock pad storage bags and complete instructions.



\$18<sup>95</sup>

Convenient assembly includes everything needed to make fast drying non-smudging rubber stamp images on valuable photographic work. Allows the photographer to place a message on proof prints to help prevent unauthorized copying. Refill quantities are available.

### ALL WEATHER WRITING

#### Rite in The Rain

##### All-Weather Photo Journal (RIAWPJ)

This 3x5" pocket sized notebook (50 sheets) enables photographers, tourists and writers to keep track of their info and shots in bad climates with a specialized page pattern. Ideal for birders, sports photographers, photojournalists and anyone else who needs to keep lists or take notes outside. Works with most pens .....4.95



##### All-Weather Pen-Black (RIAWSP)

Permanent black ink. Writes underwater and/or upside down. Use with the All-Weather Photo Journal .....7.95

##### All-Weather Birder's Field Notebook (RIAWBFN)

Designed to keep up with enthusiasts, from the backyard watcher to the active birder, this 4 1/2 x 7" book has durable side spiral binding and polyethylene cover. Inside, it has helpful reference guides and plenty of space for sketching and field notes.....6.95



#### ZTS Battery Testers

ZTS microprocessor-controlled instruments are the most accurate and versatile battery testers you can own. They compute battery's remaining power capacity using an automatic, high accuracy pulse load test. After the timed test cycle, percentage of remaining battery capacity is clearly indicated on the LED bar display. Battery types clearly labeled next to appropriate contacts. Test many popular batteries including NiMH, lithium, alkaline, coin type and more. Know exactly how much life is left. Test and replace batteries before they let you down.

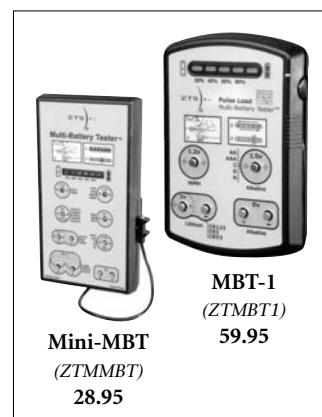

Mini-MBT  
(ZTMMBT)  
28.95

MBT-1  
(ZTMBT1)  
59.95

##### Mini-MBT Multi Battery Tester:

- 1.2V NiMH • Nicad rechargeable (AAA, AA, C, D)
- 1.5v alkaline (AAA, AA, C, D, N)
- 3v photo lithium (CR123, CR2, CRV3) • 9v alkaline, zinc-carbon

##### MBT-1 Multi Battery Tester: Same as above, plus:

- 1.5v '76' series button (S76, A76, A625, A640)
- 3v Lithium Ion (CR2016, CR2025, CR2032, 58L, 1/3N)
- 6v '28' series (28A, S28, 28L) • 6v photo lithium (2CR5, CR223, CR-P2)

GENERAL ACCESSORIES

641

# GENERAL ACCESSORIES

## CABLE RELEASES

GENERAL ACCESSORIES

### MECHANICAL CABLE RELEASES



### AIR RELEASES



**Degroff Products:** 5' air-hose with 90° connection to shutter socket #DEDG1400.....79.95

**Degroff Products:** 5' air-hose, with 10" flexible metal cable that connects to the shutter. #DEDG1600 .....79.95



**Kaiser Air (Bulb) Release -**  
Extra long bulb release that fits any camera that accepts standard mechanical cable release. Complete with reeling drum from which the tubing can be quickly unwound to the required length.  
16.5' Air (Bulb) Release #KAAR16.5.....43.50  
30' Air (Bulb) Release #KAAR33 .....47.95

**Kaiser Strap-On Cable Release Adapter for SLR & Point-n-Shoot Cameras**



Adjustable strap ties around the camera body and is positioned over the shutter release button. A standard cable release cable connected to the adapter will then apply pressure to the shutter button and trigger the camera.



#KACRASO .....35.95

642

#### Hakuba Cable Releases

- Hakuba 12" Metal Covered Cable Release with Lock #HACRM30.....13.95
- Hakuba 20" Metal Covered Cable Release with Lock #HACRM50.....16.95
- Hakuba 40" Metal Covered Cable Release with Lock #HACRM100 .....19.95

#### Hama Cable Releases

- Hama Cloth Covered Cable Release with Lock - 6" #HACRC6.....13.50
- Hama Cloth Covered Cable Release with Lock - 10" #HACRC10.....13.95
- Hama Cloth Covered Cable Release with Lock - 20" #HACRC20 .....18.95
- Hama Cloth Covered Professional Cable Release with Lock - 20" #HACRP20 .....47.50
- Hama Deluxe Cable Release - 20" #HACR20 .....29.95
- Hama Heavy Duty Cable Release with Center Lock - 10" #HACRHD10 .....24.95
- Hama Heavy Duty Cable Release with Center Lock - 30" #HACRHD30 .....29.95
- Hama Metal Covered Cable Release with Auto Lock - 10" #HACRSS10.....18.95
- Hama Metal Covered Cable Release with Auto Lock - 10" #HACRSS20 .....18.95

#### Kaiser Cable Releases

- Kaiser Cloth Covered Cable Release with Disk Lock - 10" #KACRCDL9 .....16.50
- Kaiser Cloth Covered Cable Release with Disk Lock - 20" #KACRCDL19.....19.95
- Kaiser Cloth Covered Cable Release with T-Lock - 6" #KACRCTL6.....12.50
- Kaiser Cloth Covered Cable Release with T-Lock - 10" #KACRCTL9.....9.95
- Kaiser Cloth Covered Cable Release with T-Lock - 20" #KACRCTL19 .....14.95
- Kaiser Metal Covered Cable Release with Disc Lock - 20" #KACRSSDL19 .....24.95
- Kaiser Metal Covered Cable Release with T-Lock - 10" #KACRSSTL9 .....19.95
- Kaiser Metal Covered Cable Release with T-Lock - 20" #KACRSSTL19 .....24.95
- Kaiser Professional Cable Release with Lock - 20" #KACR20 .....38.95
- Kaiser Vinyl Covered Cable Release with Disk Lock - 20" #KACRPVCDL19 .....24.50
- Kaiser Vinyl Covered Cable Release with T-Lock - 20" #KACRPVCTL19.....29.50

#### Kalt Professional Cable Releases

- Kalt Professional Cable Release - 20" #KACRP20 .....29.95
- Kalt Professional Cable Release - 40" #KACRP40 .....36.50



EQUIPMENT LEASING AVAILABLE

# GENERAL ACCESSORIES

## BODY CAPS/LENS CAPS/TOOLS

GENERAL ACCESSORIES  
643

### Snap-on Lens Caps

|                            |       |
|----------------------------|-------|
| For 30mm (GBLC30).....     | 3.50  |
| For 37mm (GBLC37).....     | 3.50  |
| For 43mm (GBLC43).....     | 3.50  |
| For 43.5mm (GBLC43.5)..... | 4.95  |
| For 46mm (GBLC46).....     | 4.95  |
| For 48mm (GBLC48).....     | 4.95  |
| For 49mm (GBLC49).....     | 4.95  |
| For 52mm (GBLC52).....     | 4.95  |
| For 55mm (GBLC55).....     | 4.95  |
| For 58mm (GBLC58).....     | 4.95  |
| For 62mm (GBLC62).....     | 5.95  |
| For 67mm (GBLC67).....     | 5.95  |
| For 72mm (GBLC72).....     | 5.95  |
| For 77mm (GBLC77).....     | 5.95  |
| For 82mm (GBLC82).....     | 11.95 |

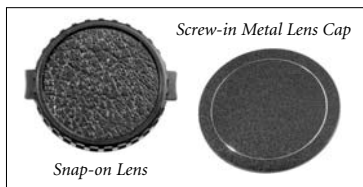

### Screw-in Metal Lens Caps

|                             |      |
|-----------------------------|------|
| For 24mm (GBLCM24).....     | 7.95 |
| For 25.5mm (GBLCM25.5)..... | 7.95 |
| For 30.5mm (GBLCM30.5)..... | 7.95 |
| For 35.5mm (GBLCM35.5)..... | 7.95 |
| For 37.5mm (GBLCM37.5)..... | 7.95 |
| For 39mm (GBLCM39).....     | 7.95 |
| For 40.5mm (GBLCM40.5)..... | 7.95 |
| For 43mm (GBLCM43).....     | 7.95 |
| For 43.5mm (GBLCM43.5)..... | 7.95 |
| For 46mm (GBLCM46).....     | 7.95 |
| For 48mm (GBLCM48).....     | 7.95 |
| For 49mm (GBLCM49).....     | 7.95 |
| For 52mm (GBLCM52).....     | 7.95 |
| For 55mm (GBLCM55).....     | 7.95 |
| For 58mm (GBLCM58).....     | 9.95 |
| For 58mm (GBLCM58).....     | 9.95 |
| For 62mm (GBLCM62).....     | 9.95 |
| For 67mm (GBLCM67).....     | 9.95 |
| For 72mm (GBLCM72).....     | 9.95 |
| For 77mm (GBLCM77).....     | 9.95 |

### Plastic Body Caps

|                              |      |                                    |      |
|------------------------------|------|------------------------------------|------|
| For Canon FD (GBBCC).....    | 3.95 | For Minolta Maxxum (GBBCMMAF)..... | 5.95 |
| For Canon EOS (GBBCCAF)..... | 5.95 | For Nikon (GBBCN).....             | 3.95 |
| For Contax (GBBCCY).....     | 3.95 | For Olympus (GBBCO).....           | 3.95 |
| For Konica (GBBCKQ).....     | 3.95 | For Pentax-K (GBBCP).....          | 3.95 |
| For Minolta (GBBCM).....     | 3.95 | For Pentax-Univ (GBBCU).....       | 3.95 |

### Metal Body Caps

|                               |       |                                    |      |
|-------------------------------|-------|------------------------------------|------|
| For Canon FD (GBBCCM).....    | 11.95 | For Minolta Maxxum (GBBCMMAF)..... | 9.95 |
| For Konica (GBBCKM).....      | 7.95  | For Pentax-Univ (GBBCMPU).....     | 6.95 |
| For Minolta MD (GBBCMMD)..... | 7.95  |                                    |      |

### Rear Lens Caps

|                                      |      |  |      |
|--------------------------------------|------|--|------|
| For Canon FD Lenses (GBLCRC).....    | 3.95 | For Olympus Lenses (GBLCRO).....           | 3.95 |
| For Canon EOS Lenses (GBLCRCAF)..... | 5.95 | For Pentax Lenses (GBLCRP).....            | 3.95 |
| For Minolta MD Lenses (GBLCRMD)..... | 3.95 | For Pentax Universal Lenses (GBLCRPU)..... | 3.95 |
| For Maxxum Lenses (GBLCRMAF).....    | 5.95 | For Yashica/Contax Lenses (GBLCRCY).....   | 3.95 |
| For Nikon Lenses (GBLCRN).....       | 3.95 | For Konica Lenses (GBLCRK).....            | 3.95 |

### Leatherman Tools

From modest beginnings, the popularity of Leatherman tools has grown rapidly. Now, millions of consumers all over the world become Leatherman owners each year, and the LEATHERMAN brand is recognized as the leader in sales, quality and innovations within the compact multipurpose tool category. Close inspection reveals the quality and attention to detail that make their products more useful and effective. Using the best stainless steel, ingenious design and rigorous tolerances, they are backed with a 25-year guarantee. A genuine Leatherman tool is always ready when you need it. And you will need it.



|  |        |   |       |
|--|--------|---|-------|
| Charge Ti - Titanium (LECTLC).....           | 109.95 | Micra (LEMY).....                               | 19.95 |
| Charge XTi - Titanium (LECXLC).....          | 109.95 | Pocket Survival (LEPST).....                    | 39.95 |
| Crunch (LEC).....                            | 68.50  | Pulse (LEP).....                                | 57.95 |
| Fuse - Stainless Finish (LEFLC).....         | 39.95  | Squirt P4 Plier - Glacier (Blue) (LESP4BL)..... | 27.50 |
| Juice C2 - Inferno (Fiery Red) (LEJ2).....   | 41.95  | Squirt P4 Plier - Inferno (Red) (LESP4R).....   | 27.50 |
| Juice CS4 - Glacial (Ice Blue) (LEJCS4)..... | 52.95  | Squirt P4 Plier - Storm (Gray) (LESP4G).....    | 27.50 |
| Juice KF4 - Gray (LEJKF4G).....              | 52.95  | Squirt S4 Plier - Glacier (Blue) (LESS4BL)..... | 27.50 |
| Juice KF4 - Solar (Yellow) (LEJKF4).....     | 52.95  | Squirt S4 Plier - Inferno (Red) (LESS4R).....   | 27.50 |
| Juice S2 - Flame (Burnt Orange) (LEJS2)..... | 41.95  | Squirt S4 Plier - Storm (Gray) (LESS4G).....    | 27.50 |
| Juice XE6 - Gray (LEJXE6G).....              | 64.95  | Super Tool 200 (LEST200).....                   | 59.95 |
| Juice XE6 - Thunder (Purple) (LEJXE6).....   | 64.95  | Super Tool 200 with Adapter (LESTWTA).....      | 74.95 |
| Kick - Stainless Finish (LEKLC).....         | 29.95  | Wave Tool - Stainless Finish (LEWLC).....       | 73.95 |



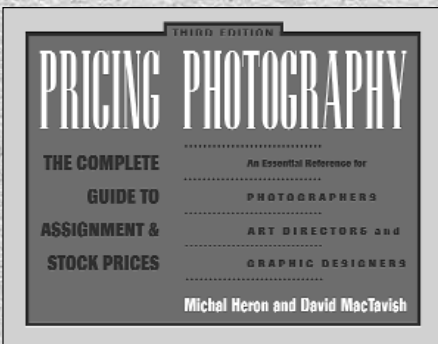
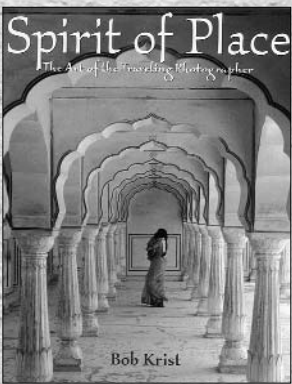
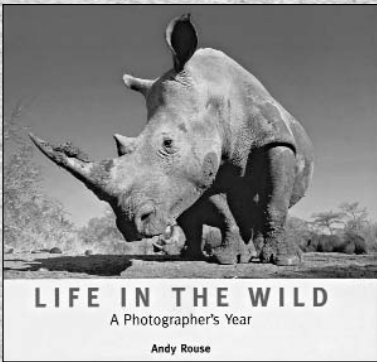
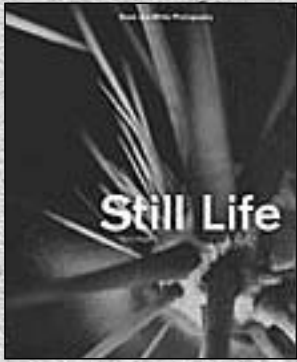



# The 35mm SLR Photo

SourceBook

## Section 8

### Library

|                            |         |
|----------------------------|---------|
| Ansel Adams.....           | 646     |
| Black & White .....        | 647     |
| Wedding .....              | 648-649 |
| Birds & Animals .....      | 650-651 |
| Nature.....                | 652-653 |
| Travel.....                | 654-655 |
| Garden Photography.....    | 656-657 |
| Landscapes.....            | 658-660 |
| Underwater .....           | 661     |
| Careers .....              | 662-663 |
| Business.....              | 664-667 |
| Exposure .....             | 668-669 |
| Portraits .....            | 670-672 |
| Photography Basics .....   | 673     |
| Children .....             | 674-675 |
| Photoshop .....            | 676     |
| Creative Composition ..... | 677     |
| Art & Craft.....           | 678-679 |
| Advanced Photography.....  | 680-681 |
| Shoot .....                | 682-683 |
| Cameras .....              | 684-685 |

# LIBRARY

## ANSEL ADAMS

LIBRARY

646

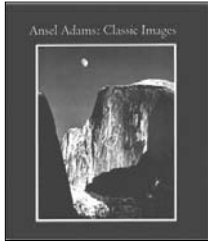

### **Classic Images**

by Ansel Adams

Chosen by Adams during the last years of his life as the finest examples of the quality and range of his artistic achievement, the 75 photographs in this book comprise a last-statement portfolio of his remarkable life's work. These photos encompass the entire scope of his work—elegant details of

nature, architectural studies, portraits, and above all, the magnificent landscapes for which he is so revered. 111 pgs.

Item # LIAACI.....39.95

### **Portfolios of Ansel Adams**

by Ansel Adams

From 1948 to 1976, Ansel Adams produced seven portfolios, each a limited edition of ten to fifteen signed photographic prints. This book reproduces all ninety of these superb images. First published in 1977, reissued in 1981 with new laser-laser-scanned separations of all the images, and then reprinted under Adam's personal supervision. 152 pgs.

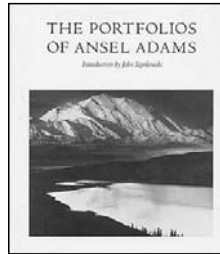

Item # LIPAA.....44.95

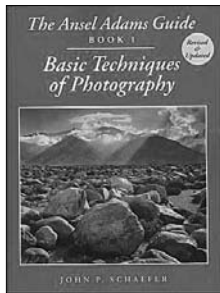

### **Basic Techniques of Photography**

by John P. Schaefer

This revised edition is organized to provide a broad range of photographers, from the serious beginner to the advanced amateur, with an understanding of the basic principles of both black-and-white and color photography. Over 50 new illustrations and current information. 418 pgs.

Item # LIAAGBTP.....36.95

### **Ansel Adams at 100**

by Ansel Adams, John Szarkowski

In celebration of the one hundredth anniversary of the birth of Ansel Adams and to accompany the exhibition, Little, Brown and Company proudly publishes the most significant book yet on his work - oversized Centennial volume edited and with a text by the legendary curator John Szarkowski. A superlative piece of bookmaking. Hardcover. 192 pgs.

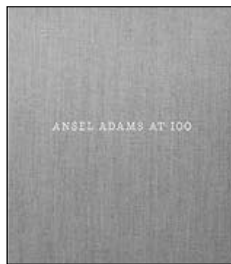

Item # LIAAA100.....149.95

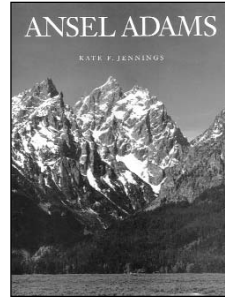

### **Ansel Adams**

by Kate F. Jennings

Perhaps the most famous of all American photographers, Ansel Adams is known for his sharp and poetic photographic images of the American West. This breathtaking selection of photographs, as well as insightful text, illuminates the life and career of Adams — and helps the reader understand the man both as an artist and conservationist. 128 pgs.

Item # STAA.....9.95

### **An Autobiography**

by Ansel Adams & Mary Street Alinder

This popularly-priced paperback edition of Adams acclaimed 1985 autobiography preserves the complete text, but reproduces a sampling of photographs rather than the extensive number of illustrations found in the original hardcover edition. With vigor and wit, America's most beloved photographer-environmentalist recalls his extraordinary six-decade career. 360 pgs.

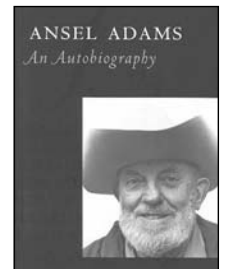

Item # LIAAAA.....14.95

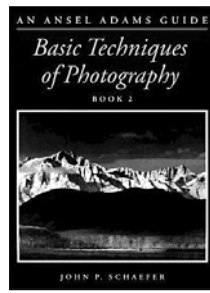

### **Basic Techniques of Photography Book 2**

by John P. Schaefer

This volume demonstrates the most important approaches to printmaking for those interested in darkroom and digital work, including such alternative printing processes as cyanotypes and gum prints. Illustrated by numerous examples of work by Ansel Adams. 386 pgs.

Item # LIAAGBTP2.....38.50

### **Ansel Adams at 100**

by Ansel Adams, John Szarkowski

In celebration of the one hundredth anniversary of the birth of Ansel Adams and to accompany the exhibition, Little, Brown and Company proudly publishes the most significant book yet on his work - an oversized Centennial volume, edited and with a text by the legendary curator John Szarkowski. A superlative piece of bookmaking. With matching slipcase. A collector's edition. 192 pgs.

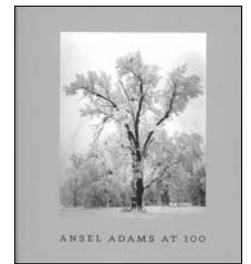

Item # LIAAA100Q.....39.95



For Any Inquiries Regarding Your Order, Call Our Customer Service:  
(800) 221-5743 • (212) 239-7765 • FAX: (800) 947-2215 • (212) 239-7549

# LIBRARY

## BLACK & WHITE

LIBRARY

647



### **Black & White Photography Still Life** Developing Style in Creative Photography by Terry Hope

The still life work of 24 photographers. Includes information from the artist on how and why it was made, plus one of each photographer's favorite tips. All the images are of a quality that would hang on anyone's wall. 144 pgs.

Item # ROBWPSTL .....29.95

### **Creative Black & White Photography**

by Les McLean

Takes readers step-by-step through the thought processes and technical procedures involved in producing high-quality black and white photographs. Les McLean starts by explaining the technicalities of the art and, more importantly, how to overcome the technical limitations of cameras and film. Explained simply and clearly. Backed up by specially commissioned photographs. 160 pgs.

Item # FWCBWP.....24.95

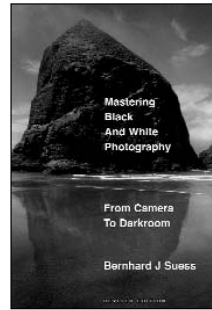

### **Mastering Black and White Photography** From Camera to Darkroom by Bernard J. Sues

Covers every aspect of the process, from choosing a camera to finding subjects and creating dazzling prints. Updated to cover digital imaging and internet technology. 40 photos and 66 b&w illus. 256 pgs.

Item # AMMBWPQ.....19.95

### **How to Photograph the Outdoors in Black & White**

by George Schaub

From an acknowledged expert in the field comes a vivid and detailed instruction in both basic and advanced techniques — as well as an explanation of equipment for black-and-white photography. 128 pgs.

Item # STHPOBW.....19.95

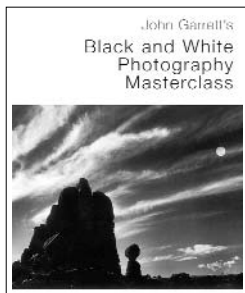
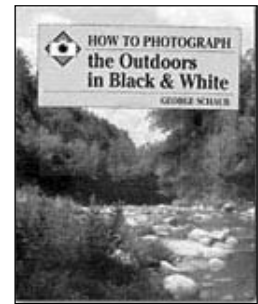

### **Black & White Photography Masterclass**

by John Garrett

An advanced class for becoming accomplished in the sophisticated art of black-and-white photography. Packed with inspiring images and practical know-how. Covers technical considerations, plus the aesthetic considerations of composition and mood. 160 pgs.

Item # AMBWPMC.....27.50

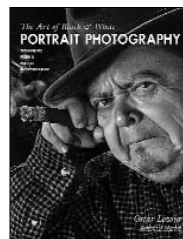

### **The Art of Black & White Portrait Photography**

Techniques from a  
Master Photographer

by Oscar Lozoya

Featuring 100 captivating images by Master Photographer Oscar Lozoya and text by Peter Skinner. Drawing on subjects ranging from regular portrait clients, to professional artists, to street people from his neighborhood, Lozoya's elegant posing and lighting techniques transform portraits into mythical scenes. 128 pgs.

Item # AMABWPP.....29.95

### **Elegant Black & White Photography**

by Sara A. Frances

Black and white is the latest trend in wedding photography. In this comprehensive guide, a master photographer demonstrates how to produce memorable elegant black-and-white wedding photography that sells. From basic technique, philosophy, and practice to style, procedure, and business concerns. 176 pgs.

Item # AMEBWPP .....29.95



### **Marketing and Selling Black & White Portrait Photography**

by Stephen Swain

A complete manual for adding b&w portraits to the products you offer clients (or offering exclusively b&w photography). Learn how to attract clients and deliver the portraits that will keep them coming back. 128 pgs.

Item # AMMSBWPP.....29.95



# LIBRARY

## WEDDING

LIBRARY

648

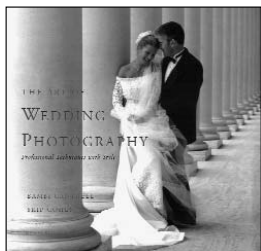

### **The Art of Wedding Photography** Professional Techniques with Style

by Bambi Cantrell & Skip Cohen

Gorgeously illustrated cutting-edge guide shows how to create the arty, yet elegant, wedding albums sought by today's bride. Creative techniques, including wedding photojournalism, for compelling pictures. Fully explores the business side of wedding photography. 144 pgs.

Item # AMAWP.....29.95

### **Photographing Weddings** by Kathy Joseph

An inspiring guide, with high-quality images accompanied by information on all technical aspects of the photographic process. The most frequently requested shots are highlighted and presented together with instructional quotes from famous photographers. A modern approach to wedding photography. Shows diverse international styles and how they can be mastered by photographers of all skill levels. 144 pgs.



Item # ROPW.....34.95

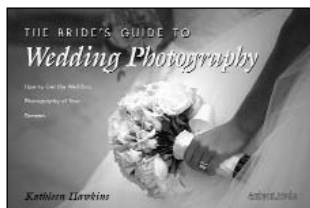

### **The Bride's Guide to Wedding Photography**

by Kathleen Hawkins

Learn how to get the wedding images of your dreams! This guide will show you how to orchestrate every aspect of your

wedding photography, from identifying a style that suits you, to hiring a photographer, to selecting makeup, flowers, and clothing that will photograph well, and much more. 112 pgs.

Item # AMBGWP.....14.95

### **Wedding Photojournalism** by Andy Marcus

Learn the art of creating dramatic unposed wedding portraits. Learn where to be, what to look for and how to capture it on film. A hot technique for contemporary wedding albums. Andy Marcus is a professional wedding photographer who has shot thousands of weddings, including the nuptials of Donald Trump, Billy Baldwin, Eddie Murphy, Art Garfunkel and Mary Tyler Moore. 128 pgs.

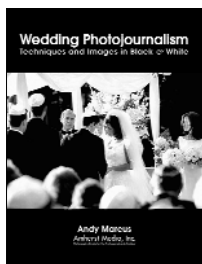

Item # AMWJP.....29.95



### **Professional Techniques for the Wedding Photographer**

Lighting, Posing & Taking Photographs that Sell

by George Schaub,  
Photographs by Ken Sklute

New edition of the mega-best-seller, revised and updated to include the latest trends in photography, digital imaging, and using the Internet. Hundreds of approaches and over 150 stunning photographs. 144 pgs.

Item # AMPTWP.....24.95

### **Wedding Photography** Getting perfect results every time

by Ian Gee

For amateur and professional photographers alike, this book presents creative ideas on lighting, using flash, posing individuals, couples and groups, with the main objective being the creation of successful wedding photographs. Stunning illustrations with accompanying advice and techniques. 144 pgs.

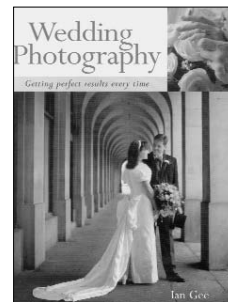

Item # STWP.....24.95

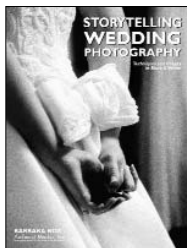

### **Storytelling Wedding Photography**

by Barbara Box

Barbara and her husband shoot as a team at weddings. Here, she shows you how to create outstanding candids (her specialty), and combine them with formal portraits (her husband's specialty) to create a unique wedding album. Barbara's fresh wedding images have won numerous prestigious awards in national competition and have appeared in professional photography magazines. 112 pgs.

Item # AMSTWP.....29.95

### **Capture the Moment** A Bride's and Photographer's Guide to Contemporary Weddings

by Stephen Swain

Treasure that magical moment. Hundreds of useful tips on how to capture the most lovely and intimate portraits of your special day. Know how to prepare, plan, and what to expect during the meeting and booking stages. Outstanding contemporary photographs. This is the one book you'll need to ensure a lifetime of memories. 160 pgs.



Item # STCMBGW.....34.95



EQUIPMENT LEASING AVAILABLE



# LIBRARY

## WEDDING

LIBRARY

649

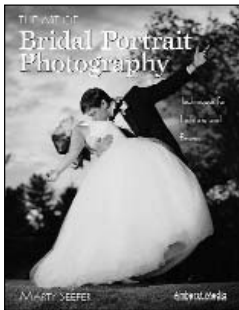

### **The Art of Bridal Portrait Photography** Techniques for Lighting and Posing by Marty Seefer

The photographer is guided through every step of the bridal shoot to ensure results that the client will cherish. From metering the light to location and studio shots, to corrective lighting techniques. Seefer does not miss a step. 128 pgs.

Item # AMABPP.....29.95

### **Professional Secrets of Wedding Photography**

by Douglas Allen Box, 2nd Edition

With the comprehensive advice in these illustrated pages, a bride can figure out what she wants from her wedding photography. Traditional or a journalistic style? Will there be time for formal portraits? Which gowns, flowers, make-up, and poses will look best in photos? From different packages to ordering enlargements, they'll understand the total picture. 128 pgs.



Item # AMPSWP.....29.95



### **Weddings**

by Annabel Williams

From one of the UK's leading commercial photographers, 'Weddings' is an essential resource for serious photographers who are keen to master the contemporary approach to wedding photography: contains all the details, practical advice and technical know-how anyone would need. 144 pgs.

Item # ROCPW.....34.95

### **Wedding and Studio Portrait Photography**

The Professional Way

by Jonathan Hilton

Covers two of the most popular subjects for enthusiastic amateurs and semi-professionals: portraits and weddings. Discover how images were created. Easy-to-understand sections, such as 'Bride and Groom' and 'Going away'. Create a happy couple's album of precious memories. 288 pgs.



Item # ROWSPP.....34.95

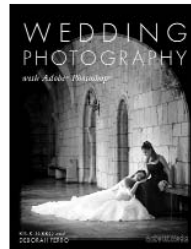

### **Wedding Photography with Adobe Photoshop**

by Rick Ferro and Deborah Ferro

Get the skills you need to make your images look their best, add artistic effects, and boost sales. From shooting tips to techniques for creating savvy marketing pieces with Adobe Photoshop. Rick Ferro who has shot over 10,000 weddings and Deborah Ferro who is a professional image editor, will help you make the most of your artistic and business skills. 128 Pages

Item # AMWPAP.....29.95

### **Best of Wedding Photography**

Techniques and Images

From the Pros

by Bill Hurter

Learn the techniques used by professional wedding photographers to identify and capture that perfect, romantic moment. Create flattering, attractive poses of the bride, groom, wedding party and family. Classic and contemporary styles of wedding photography, and much more. 128 pgs.

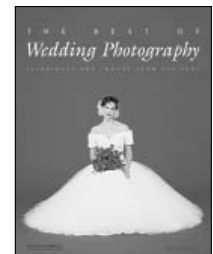

Item # AMBWP.....29.95

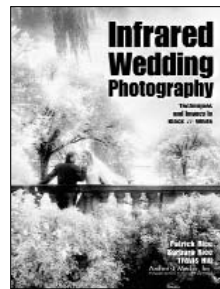

### **Infrared Wedding Photography**

Techniques and Images  
in Black & White

by Patrick & Barbara Rise, Travis Hill

Step-by-step techniques for adding the dreamy look of black & white infrared to your wedding portraiture. Capture the fantasy of the wedding with unique ethereal portraits your clients will love! 128 pgs.

Item # AMIWP.....29.95

### **Photographer's Guide to Wedding Album Design and Sales**

by Bob Coates

Wedding albums are an immense source of pride and income for professional wedding photographers. The trend toward personal, exquisitely designed albums has left photographers new to album design looking for practical, efficient information and inspiration. With techniques from fifteen of the best-regarded album designers. 128 pgs.

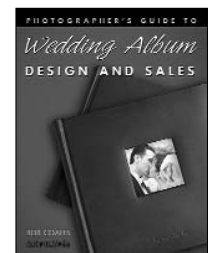

Item # AMWADS.....29.95

ORDER & INFO. (212) 502-6340 • FAX: (212) 239-7770 (800) 947-7008  
1-800-290-6750 • www.bhphotovideo.com



# LIBRARY

## BIRDS OF A FEATHER

LIBRARY

650

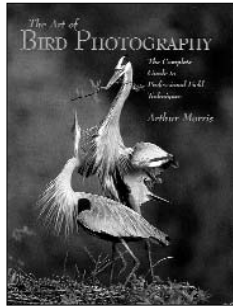

**The Art of  
Bird Photography**  
The Complete Guide to  
Professional Field Techniques  
by Arthur Morris

The perfect guide to capturing images of avian subjects. Includes advice for capturing bird behavior and action, working in the field, approaching wild birds, selling your work, and even the best bird-watching spots. 160 pgs.

Item # AMABP.....24.95

**National Geographic  
Photography Field Guide  
Birds**

by Rulon Simmons and Bates Littlehales

Combining National Geographic's unparalleled expertise in the fields of birding and photography, this guide is a much needed, all-in-one resource for the avid and growing bird-photography market. A great resource for bird photographers — in the field or at your backyard feeder. 160 pgs.

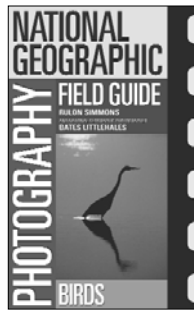

Item # AMNGPGB.....21.95

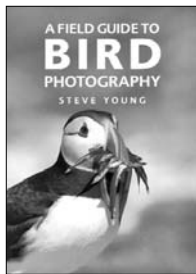

**A Field Guide To  
Bird Photography**  
by Niall Benvie

A must-have field guide illustrated by the author's spectacular work. Features everything you need to know to photograph birds successfully and artistically. Beginners will appreciate suggestions for taking their first great pictures. Tips for taking photographs in every season, and a handy bird photography notebook to keep track of crucial information in the field.

Item # STFGPB.....14.95

**An Essential Guide To  
Bird Photography**  
by Steve Young

Capture the beauty of birds on film—whether they're in flight, feeding, bathing, or even mating. One of the world's top bird photographers covers all aspects of shooting, from setting up a hide in your garden to finding rarities. One of the finest photographic handbook of its kind — and a most delightful account of one patient artist's passion for birds. 160 pgs.

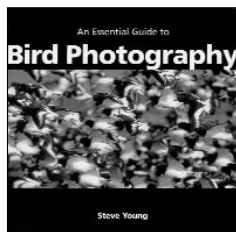

Item # STEGBP.....19.95

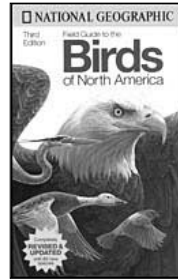

**National Geographic Field Guide to the  
Birds of North America**

by National Geographic Society, 4th Edition

The ultimate birder's field guide. Features the most complete information available on every bird species known to North America. This revised edition features 250 completely updated range maps, new plumage and species classification information, specially commissioned full-color illustrations, and a superb new index that allows birders in the field to quickly identify a species. 480 pgs.

Item # AMNGGBNA.....19.95

**Book of  
North American Birds**

by Readers Digest Editors

The birds of North America are an endless source of delight to anyone who enjoys nature. This attractive and informative book of 600 species includes a "special collection" of more than 100 species that are rare. Each portrait includes full color original artwork; details on identification, habitat, nesting, and food; and a color coded range map. 576 pgs.

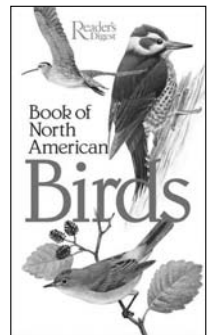

Item # PERDENAB.....19.95

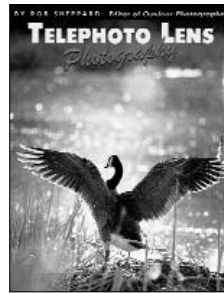

**Telephoto Lens  
Photography**

by Rob Sheppard

The complete guide to telephoto lenses. PC Photo and Outdoor Photographer magazine editor, Sheppard has worked as a naturalist, a photojournalist, a commercial photographer and a video producer. Over 100 b&w and color photos taken with a telephoto lens. Rob Sheppard is Over 100 b&w and color photos. 112 pgs.

Item # AMTLP.....17.95

**The Master Guide For  
Wildlife Photographers**

by Bill Silliker, Jr.

Creating quality images of wildlife requires three ingredients: the right equipment, some skill at using it, and the knowledge of a field naturalist. In this book, Master Photographer Bill Silliker shows you how to use tracking calls, and blinds—strategies typically used by hunters to get close to animals—to get intimate portraits of wild subjects. 128 pgs.

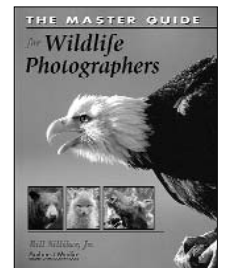

Item # AMMGWP.....29.95



EQUIPMENT LEASING AVAILABLE



# LIBRARY

## WILD & DOMESTICATES

LIBRARY

651



### **Dynamic Wildlife Photography** Techniques for Creating Captivating Images by Cathy and Gordon Illg

Impress the viewers of wildlife photography who see thousands of photos from around the world. Learn how to creating dynamic images that are truly dramatic and unique. Over 150 full color photos. 128 pgs.

Item # AMDWP .....29.95

### **When and How to Photograph Wildlife** by Peter Evans

If animals, travel, and pictures are your passion, load your cameras and get set for a photographic safari! A world-class photographer – winner of a silver medal from the Photographic Society of America – shows off his breathtaking work and reveals how you, too, can take memorable images of wildlife in their own habitats. What you learn here will make all your wildlife pictures perfect. All in color. 180 pgs.

Item # STWHPW .....29.95

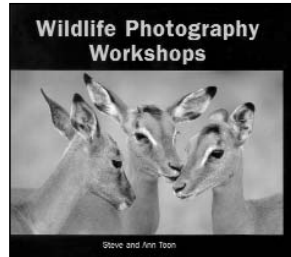
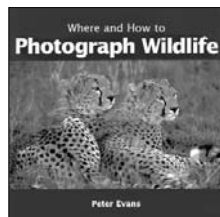

### **Wildlife Photography Workshops** by Steve and Ann Toon

Nearly 150 exquisite examples of wildlife photography, including professional tips on choosing and using various camera systems, the basics of composition and perspective, understanding the behavior of your animal subjects, and critical techniques of photographic storytelling. 168 pgs.

Item # STWPW .....29.95

### **Life in the Wild** A Photographer's Year by Andy Rouse

One of the best at the art of wildlife photography presents a year of his work in an informative and visually remarkable diary. Each month includes valuable information on planning a trip, packing equipment, and taking the actual shot.

Breathtaking examples of the author's pictures. All in color. 192 pgs.

Item # STLW .....29.95

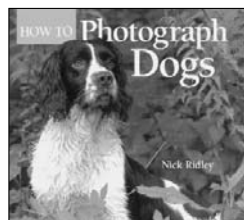
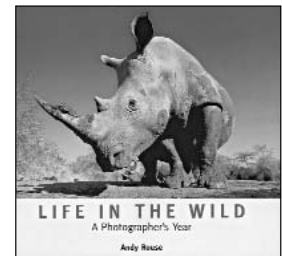

### **How to Photograph Dogs** by Nick Ridley

Dog lovers and photographers alike will love this manual on how to take great shots of man's best friend. Plenty of color images add extra appeal to the advice on equipment, dog behavior and handling puppies during a shoot. All the tricks of the trade are here, with techniques for capturing Fido in any situation—at work, resting, and at play. Every suggestion is easy to follow and fun to try. 156 pgs.

Item # SHTPD .....24.95

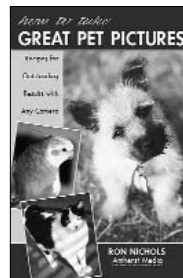

### **How to Take Great Pet Pictures** Recipes for Outstanding Results with any Camera by Ron Nichols

With simple recipes for success, Ron Nichols – a University of Utah photography instructor, award-winning photojournalist and animal enthusiast – shows you how to capture highly memorable shots that will create timeless images to treasure for years. 40 color photos. 80 pgs.

Item # AMHTGPP .....14.95

### **Professional Techniques for Pet and Animal Photography** by Debrah H. Muska

Deb Muska shows readers how to work magic—from earning the subject's trust, to downplaying flaws, to capturing their unique personalities in images that the average pet owner—or breeder—will cherish. An overview of methods used and chapters devoted exclusively to photographing dogs, cats, horses, reptiles, and more. 128 pgs.

Item # AMPAPQ .....29.95

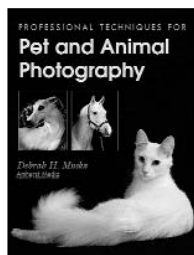

### **How to Photograph Pets** by Nick Ridley

Photographing animals can be a challenge. Capture that lasting portrait of your treasured pet with the help of a professional who has an in-depth knowledge of both photography and animal behavior. He assumes no prior knowledge--and any camera will do. Understand your pet's body language; begin to understand the finer points of composition and lighting; choose a suitable background, indoors or out; catch the animal in motion. 168 pgs.

Item # STHTP .....24.95

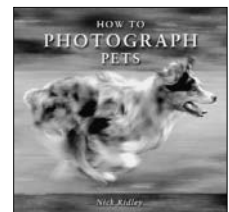

# LIBRARY

## NATURE in the WILDERNESS

LIBRARY

652

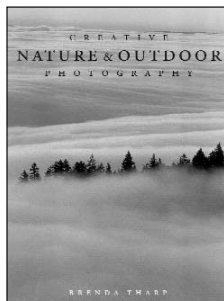

### **Creative Nature & Outdoor Photography**

by Brenda Tharp

Packed with dozens of surefire strategies. Demonstrates how to use classic visual design principles to create compelling nature photos. Includes practical advice on lighting, color, visual design, and more. Incorporates classic design principles with a deeper understanding of the natural world and its "moments." 160 pgs.

Item # AMCNOP .....24.95

### **Nature Photography Field Guide**

by John Shaw

This book of extraordinary photographs of nature contains solid instruction on how any photographer can aim for equally impressive results every time a camera is focused on the great outdoors. Using his own exceptional work as examples, the author discusses each type of nature subject and how to approach photographing it. 160 pgs.

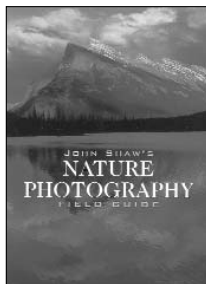

Item # AMJSNPGF.....24.95



### **The Best Of Nature Photography**

Images and Techniques from the Pros  
by Jenni Bidner and Melena Wagner

Favorite shooting techniques from legendary nature photographers. Learn how each photographer has learned to express his or her creative vision. Fascinating text with over 150 stunning world-class images, with an inside look at the photographers who risk

their equipment, safety and sometimes their lives. 128 pgs.

Item # AMBNP.....29.95

### **Ghosts in the Wilderness**

Abandoned America

by Tony and Eva Worobiec

Over a 7-year period, Tony and Eva Worobiec, two of the greatest photographers of all time, traveled the dusty paths of rural America. Along with the evocative and beautiful images of abandoned farms, schools, gas stations, grain elevators, tractors, diners and trucks — are the words of the remaining residents. 176 pgs.

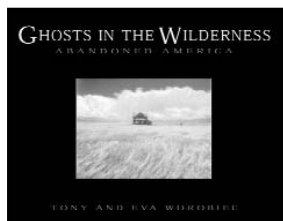

Item # STGW .....60.00

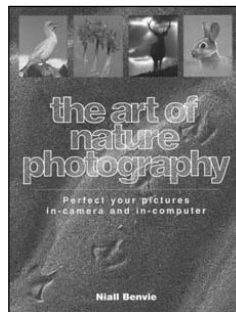

### **The Art of Nature Photography**

by Niall Benvie

This definitive, up-to-the-minute book on the popular field of nature photography instructs the reader in the techniques needed to consistently create stunning images based on the very latest camera and computer innovations. Stunning color photographs display the beauty and wonder of nature. 160 pgs.

Item # AMANP .....24.95

### **Beginner's Guide To Nature Photography**

by Cub Kahn

Whether you like strolling in a neighborhood park or prefer hiking through a million-acre wilderness area, the magic of nature photography is available all around you. With the techniques in this book, beginners will learn how they can start producing consistently excellent nature photographs. 96 pgs.

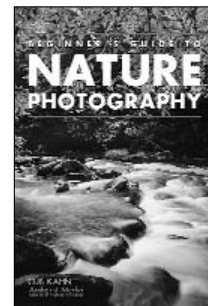

Item # AMBGNP.....14.95

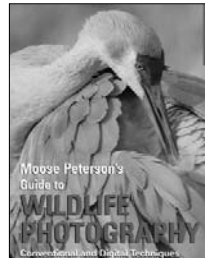

### **Wildlife Photography**

A Professional's Guide to Marketing and Managing a Successful Nature Photography Business

by Moose Peterson

The author has focused on some of the world's rarest and most charismatic wildlife for over two decades. By combining modern camera technology with a vast knowledge of biology, he hopes to educate the public about our wildlife heritage through photography and words. 192 pgs.

Item # STMPGWP .....24.95

### **Outdoor and Survival Skills for Nature Photographers**

by Ralph LaPlant and Amy Sharpe

Learn to have a safe and productive shoot. LaPlant is a Tribal Conservation Officer, avid photographer and paramedic who has given courses in outdoor survival. Sharpe is a journalist and naturalist who has taught outdoor education, forest ecology and outdoor living skills. 80 pgs.

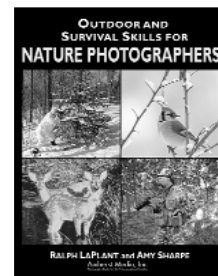

Item # AMOSSNP.....17.95



For Any Inquiries Regarding Your Order, Call Our Customer Service:  
(800) 221-5743 • (212) 239-7765 • FAX: (800) 947-2215 • (212) 239-7549

# LIBRARY

## NATURE UP CLOSE

LIBRARY

653

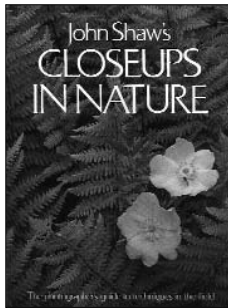

### Closeups in Nature by John Shaw

One of the country's foremost nature photographers offers closeup techniques and covers exposure, equipment, and composition, along with special equipment and lenses. Specific applications include: extension tubes and bellows, macro lenses; internal focusing lenses, zoom lenses, supplementary lenses, teleconverters, flash and lighting. 144 pgs.

Item # AMJSCUNP .....22.50

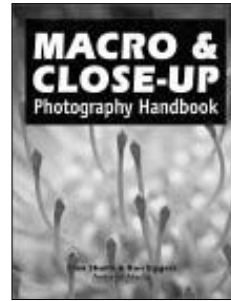

### Macro and Close-Up Photography Handbook by Ron Eggers & Stan Sholik

Capture breathtaking images of small subjects: flowers, stamps, jewelry, insects, etc. Designed with the 35mm shooter in mind. Full of step-by-step techniques. Create fascinating images of features too small to be adequately observed by the unaided human eye. For the novice and professional photographer. 120 pgs.

Item # AMMCUPHB.....29.95

### Nature Photography Close Up Macro Techniques in the Field by Paul Harcourt Davies

Featuring a unique "think small" approach to the unseen wonders around us, this guide contains dozens of photos accompanied by essays about how each picture was created. Combines photography's artistic techniques with the love of nature. 160 pgs.

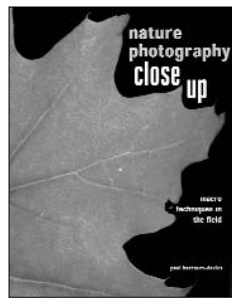

Item # AMNPCU.....29.95

### Focus on Nature The Creative Process Behind Making Great Photographs in the Field by John Shaw

A best-selling author explains the creative process behind his spectacular photographs — how he decides exactly what to include in a photograph, how he organizes a photograph, and how he visualizes what he wants a photograph to be. Showcasing of more than 100 of Shaw's most breathtaking images. 144 pgs.

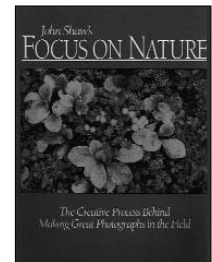

Item # AMJSFNP .....22.50

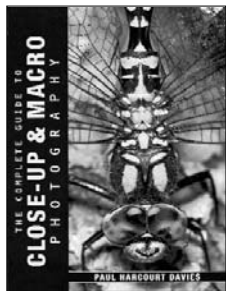

### Complete Guide to Close-Up & Macro Photography by Paul Harcourt Davies

Explore the hidden world of pattern, texture and detail to create stunning details without breaking the bank. Equipment, lighting and technique are discussed in detail. 200 Stunning color illustrations. 160 pgs.

Item # FWCGCUMP.....24.95



### Close-Up Creative Techniques for Successful Macro Photography by John Brackenbury

An awe-inspiring book that takes the reader behind the lens with one of the world's foremost experts specializing in macro photography. This fascinating book will help you master the intricate art. Illustrated with 150 incredible shots from Brackenbury's personal portfolio. 160 pgs.

Item # ROCU.....34.95

### How to Photograph Close Ups in Nature

by Nancy Rotenberg & Michael Lustbader

A guide to macro-photography gear and techniques, illustrated with dazzling color photos. Learn how to recognize and compose intimate natural scenes. Stunning small-scale images await the photographer with the eye and skill to capture them. The authors create personal masterpieces. 142 pgs.



Item # STHPCUN .....19.95

### Close-Up Photography by Alan Constant

The first part of this book is dedicated to the technical side of closeup work: equipment, metering, special problems, magnification and methods of achieving it, lighting, and electronic flash. The second is the practical side of close-up work. Heavily illustrated with diagrams, tables and color throughout. Many tricks and tips. 128 pgs.

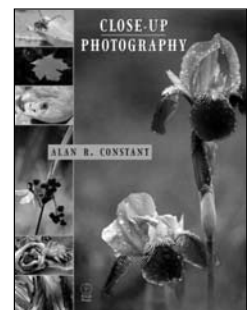

Item # FOCUP .....39.95

ORDER & INFO. (212) 502-6340 • FAX: (212) 239-7770 (800) 947-7008  
1-800-290-6750 • www.bhphotovideo.com



# LIBRARY

## TRAILS & TRAVELS

LIBRARY

654

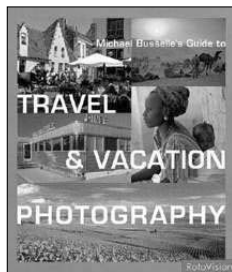

### Michael Busselle's Guide To Travel & Vacation Photography

by Michael Busselle

Shooting without preparation will leave you with a disappointing photograph. Capture lasting and worthwhile records of your travels with this indispensable guide. A whole section on choosing lenses, film, cameras and lighting

accessories—truly a complete and accessible guide to all. 207 pgs.

Item # ROTVP.....24.95

### The Photographer's Travel Guide

Where and When to Go  
to Get the Shots You Want

by William Manning, Detley Motz  
and Christian Heeb

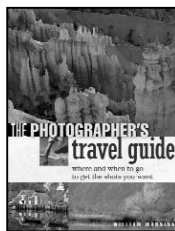

Guides readers on trip planning, selecting the best equipment for a given location, time-saving shortcuts and the best locations for taking stunning photographs of a variety of subjects. Covers dozens of places throughout the U.S. and Canada. More than 100 photos in all. 83 pgs.

Item # FWPTG.....27.95



### Photographer's Guide to Yellowstone and the Tetons

by Joseph K. Lange

A first-ever guide to Yellowstone and the Tetons especially for photographers. Dramatic geysers, glittering waterways, majestic mountains, unique wild animals. Where and when to go, how to find the best shots, what equipment to take and techniques to use, park rules and regulations, how to avoid the crowds.

Stunningly illustrated with brilliant color images. 128 pgs.

Item # STPGYST.....14.95

### Travel Photography

by Christian Heeb, Detley Motz

Striking photos from around the globe, by inspiring photographers who capture stunning shots of their own. Internationally known US based travel photographers Christian Heeb and Detley Motz present this collection of spectacular photographs from all over the world. A book for amateur and professional photographers alike who just want to get away with their camera! 128 pgs.

Item # FWTP.....24.95



### Photographer's Guide to the Grand Canyon & North Arizona

by Joseph K. Lange

Find a wealth of wonderful images in the landscapes of the Grand Canyon and Northern Arizona: spectacular canyons, towering spires, picturesque arches, and colorful dunes. Where and when to go, equipment to use, techniques to use, park rules and regulations, etc. Stunning Arizona scenics. 122 pgs.

Item # STPGGCA.....14.95

### Travel Photography

by Susan McCartney

This new edition will help every photographer, whether amateur or experienced, to uncover new ways of taking exceptional pictures on the road. World-acclaimed travel photographer Susan McCartney offers both a definitive guide to honing skills as well as a business manual of expert tips for making each endeavor profitable. 360 pgs.

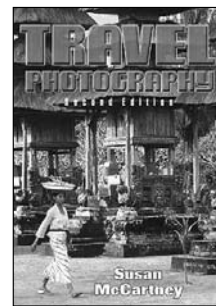

Item # AMTPY.....22.95

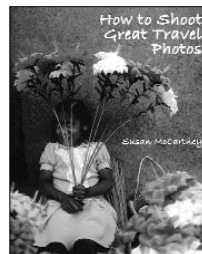

### How To Shoot Great Travel Photos

by Susan McCartney

Illustrated with 150 breathtaking images from the author's own collection. A comprehensive road map to the challenges and rewards of capturing original, top-notch travel photos. World traveler and master photographer, Susan McCartney, provides tested techniques for shooting magnificent

photographs at practically every exotic scenario imaginable. 144 pgs.

Item # AMHSGTP.....24.95

### Double Vision

by Christopher Weston

and Nigel Hicks

One hundred of their finest photographs feature landscapes as diverse as the crashing fury of the Bali seashore and the cloud-tipped mountains of Nepal. In-depth discussions about the equipment and techniques used to achieve each shot, as well as tips for attaining similar results in your own photographs. 156 pgs.

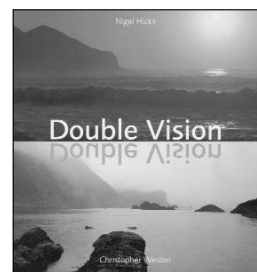

Item # STDV.....29.95



For Any Inquiries Regarding Your Order, Call Our Customer Service:  
(800) 221-5743 • (212) 239-7765 • FAX: (800) 947-2215 • (212) 239-7549

# LIBRARY

## TRAILS & TRAVELS

LIBRARY

655

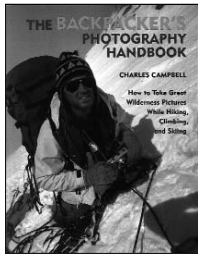

### **The Backpacker's Photography Handbook** How to Take Great Pictures While Hiking, Climbing, and Skiing by Charles Campbell

A field guide to wilderness photography. Whether you're on an afternoon hike or scaling the Himalayas, backpacking adventures are ideal for taking spectacular pictures. This book covers all the rigors of living and photographing outdoors, from protecting equipment to shooting on the move. 144 pgs.

Item # AMBPPHB.....19.95

### **Photographing Wilderness** by Jason Friend

Taken in locations as diverse as the United States and Western Samoa, these magnificent landscapes provide beautiful and instructive examples of what a photographer can achieve even in the most challenging environments. A comprehensive hiking and photographic guide and impressive record of one man's journey to some of the world's most breathtaking untouched settings. 168 pgs.

Item # STPWQ.....24.95

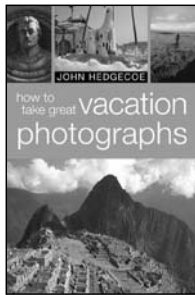
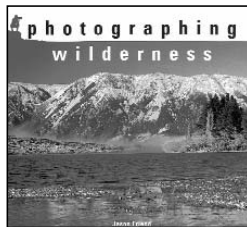

### **How To Take Great Vacation Photographs** by John Hedgecoe

A dream guide, easy-to-follow, abundantly illustrated and practical. Expert advice and novel techniques, vividly illustrated with 250 photos of popular vacation locales, from mountaintop to seashore. With Hedgecoe's innovative approach, anyone can create memorable images. 160 pgs.

Item # STHMGVP .....24.95

### **Travel Photography** How to Research, Produce and Sell Great Travel Pictures by Roger Hicks and Frances Schultz

The book is written from the author's first hand experience of shooting travel pictures for publication. Illustrated in color throughout with captions to describe each picture and how it was taken, this book is both an inspirational guide and excellent source of advice for the aspiring travel photographer. 208 pgs.

Item # FOTP.....38.95

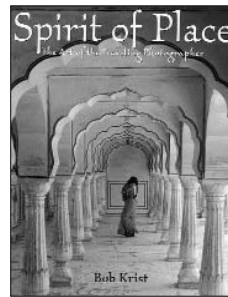
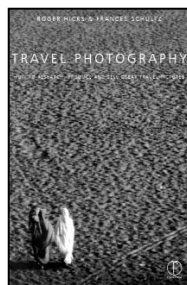

### **Spirit of Place** The Art of the Traveling Photographer by Bob Krist

Exquisite, lavishly illustrated and instructive pages on how artful camera use can record the true spirit of a place. Take memorable pictures of people, festivals, wildlife, architecture, aerial and underwater shots. Directions for working in both natural and artificial light. 160 pgs.

Item # AMSPX.....24.95

### **Guide to Climbing Photography** by Jeff Achey

Whether you're a climber who wants to record your adventures or a photographer who wants to learn how to shoot climbers in action, this essential guide is the first to focus solely on the sport. A professional adventure photographer and expert climber explains gear and technique and offers a gallery of superb shots. 128 pgs.

Item # STGCP.....16.95

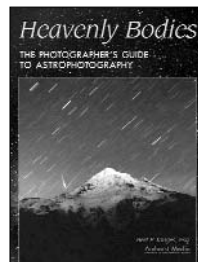
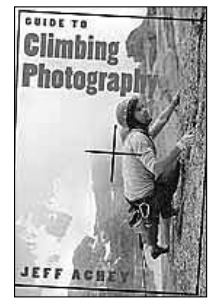

### **Heavenly Bodies** The Photographer's Guide to Astrophotography by Bert P. Krages, Esq.

Reach for your camera and then reach for the stars. If you ever wanted to capture the glory of a shooting star, image a distant planet, this book is for you. With some basic skill, minimal photographic equipment, and some intermediate-level astronomical tools, you'll be on your way to getting the images you desire. 128 pgs.

Item # AMHB.....29.95

### **Scenic Photography 101** A Crash Course to Shooting Better Pictures Outdoors by Kerry Drager

Offering an all-inclusive range of the subjects people want to photograph outdoors, this book shows landscapes, seascapes, desert scenes, city views, country settings, and historic sites. 144 pgs.

Item # AMSP101 .....24.95

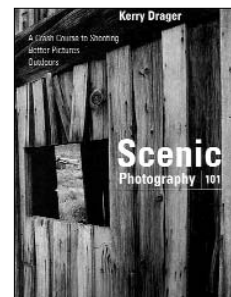

ORDER & INFO. (212) 502-6340 • FAX: (212) 239-7770 (800) 947-7008  
1-800-290-6750 • www.bhphotovideo.com



# LIBRARY

## OUTDOOR, NATURE, GARDEN

LIBRARY

656

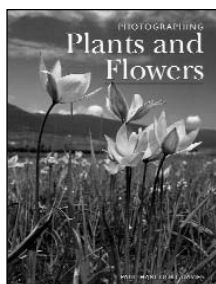

### **Photographing Plants and Flowers**

by Paul Harcourt Davies

The complete guide to photographing plants and flowers in gardens, the studio, or the wild—destined to become the plant photographer's bible. Learn how to "see" the art and design of plants and flowers. Take imaginative photographs that both record and create an inspirational work of art. A must-have addition to every photographer's library! 160 pgs.

Item # AMPPF.....29.95

### **Garden Photography A Professional Guide**

by Tony Cooper

Superb color photography, an authoritative text and an engaging and artistic approach make this the most inspiring guide to capturing the garden in all its varied splendor. In-depth focus on garden specifics, such as changes through the seasons, different locations, plant portraits, garden buildings and backyard wildlife. 156 pgs.

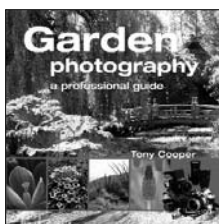

Item # STGPPG.....24.95

### **How to Photograph Flowers**

by Heather Angel

An internationally known nature photographer and author describes equipment, film, lighting, composition and special techniques for photographing flowers in the wild and in gardens. Explores the challenges of wind, light, and problem colors. Also includes tips on making money from nature photography. 144 pgs.

Item # STHPF.....19.95

### **Photographing Flowers Inspiration, Equipment, Technique**

by Sue Bishop and Charlie Waite

This sumptuous manual covers all the practical skills and aesthetic considerations involved in shooting an array of blossoms. Equipment, lighting, exposure, depth of field; using color; and artistic concerns such as the use of backgrounds, soft focus, and special effects. 156 pgs.

Item # STPF.....24.95

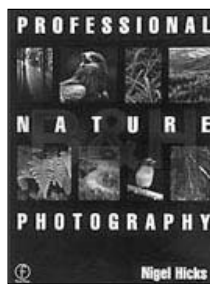

### **Professional Nature Photography**

by Nigel Hicks

Packed with hints, tips and essential information, this is a practical guide to getting started as a professional nature photographer. It focuses on how the industry works, recognizing that success in this profession does not rely entirely on your skills of photography, but also on how you organize and market those talents. Full of practical advice. 182 pgs.

Item # FOPNP.....39.95

### **Essential Skills for Nature Photography**

by Cub Kahn

Learn all the skills you need from a professional nature photographer, writer and environmental educator who teaches workshops on nature photography. Includes: selecting equipment, choosing locations, filters, and more. Over 70 color and b&w photos. 128 pgs.

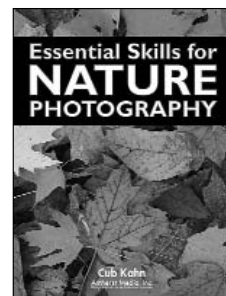

Item # AMESNP.....29.95

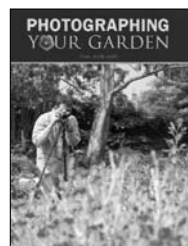

### **Photographing Your Garden**

by Gail Harland

This guide is geared to the needs of the devoted gardener who lovingly plants and tends to flowers, shrubs and trees. Sumptuous and vibrant images, taken by the author, showcase and teach every aspect of garden photography. Equipment and its various uses, choosing a subject and selecting a style, archiving the final images—by the time you reach the final page, you'll have the expertise to produce your own portfolio. 192 pgs.

Item # STPYG.....19.95

### **How to Photograph Insects and Spiders**

by Larry West with Julie Ridl

The third volume in Stackpole's popular 'How to Photograph' series, this one is filled with stunning images and helpful information on technique. A valuable reference for beginning, intermediate, and advanced nature photographers. 128 pgs.



Item # STHPIS.....19.95



For Any Inquiries Regarding Your Order, Call Our Customer Service:  
(800) 221-5743 • (212) 239-7765 • FAX: (800) 947-2215 • (212) 239-7549

# LIBRARY

## OUTDOOR, NATURE, GARDEN

LIBRARY

657



### **Loving Nature The Right Way** by William W. Hartley, Bruce R. Hopkins (Editor)

Bill Hartley explains a biologically correct approach to savoring wild places and viewing wildlife. This book contains more than 100 thought-provoking photos of landscapes, wildflowers, birds and rare animals. It is authored by Bruce R. Hopkins. 160 pgs.

Item # BOBLNRW .....19.95

### **Photographing the Patterns of Nature** by Gary Braasch

A beloved classic, updated with 80 new images, this is the first book to teach classic composition for nature pictures. Flowers, trees, clouds, animals, mountains, rocks, sea-shells—learn how to recognize the lines, shapes, textures, colors, and movements that make up life itself. 144 pgs.

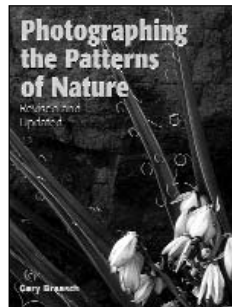

Item # AMPPNQ.....24.95

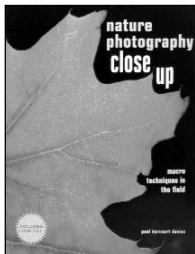

### **Nature Photography Close Up** by Paul Harcourt Davies

Zooming in on the “faces” of dragonflies and hornets, unearthing the intricate patterns of fungi and mosses, and even capturing the active beauty of plankton, Davies presents a “think small” approach to natural subjects. With dozens of full-color photographs, each accompanied by a succinct and insightful essay, this gorgeous book doubles as a

showcase and an instructional guide. 160 pgs.

Item # AMNPCU .....29.95

### **Photographing Plants and Gardens**

by John Doornkamp

Written for anyone who wants to make a photographic record of the beauty they find in plants and gardens. The author clearly explains his practical approach and how to master basic skills that will ensure success. Chapters include: composition, choosing the right lens, flowers in close-up, filters, film choice, and much more. 96 pgs.

Item # HOPPG.....19.95

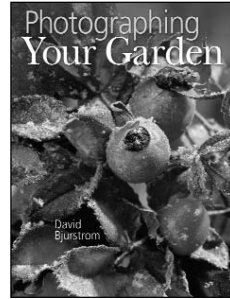
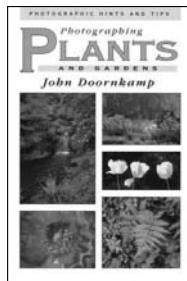

### **Photographing Your Garden** by David Bjurstrom

Large, richly colored images of roses, plump tomatoes on the vine, and shimmering trees shot from below. Find out the advantages and drawbacks of different cameras and tripods; what accessories make for a smooth shoot; and which specialized lenses and filters open up creative vistas. All in color. 128pgs.

Item # STPG.....24.95

### **How to Photograph Reptiles and Amphibians** by Larry West and William P. Leonard

Much more than a detailed technical guide, it's also a good introduction for any outdoor enthusiast to the wonders of “creeping things” – snakes, lizards, frogs, toads, turtles, and salamanders. Also learn how to select and adapt photo gear for use in the swamp and wetland. 128 pgs.

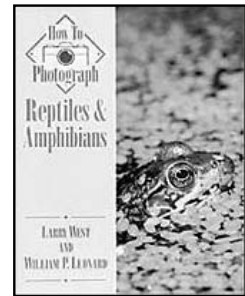

Item # STHPRA .....16.95

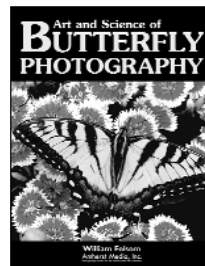

### **Art and Science of Butterfly Photography** by William Folsom

Discover the photographic techniques for capturing breath-taking images of colorful butterflies. Understand and predict butterfly behavior and when to photograph them. William Folsom is a professional photographer whose photographs of the natural world have appeared internationally in

numerous books, calendars, postcards and advertisements. 120 pgs.

Item # AMASBP.....29.95

### **The Complete Guide to Outdoor Photography** by Paul Harcourt Davies

Easy-to-follow, practical guide. Useful tips for choosing film for particular lighting or climactic conditions, to capturing elusive shots that sum up the essence of an intriguing location. Tips and tricks to turn everyday snaps into something really special. 160 pgs.

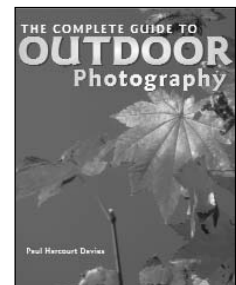

Item # FWCGOP.....29.95

ORDER & INFO. (212) 502-6340 • FAX: (212) 239-7770 (800) 947-7008  
1-800-290-6750 • www.bhphotovideo.com





# LIBRARY

## LANDSCAPE

LIBRARY

658

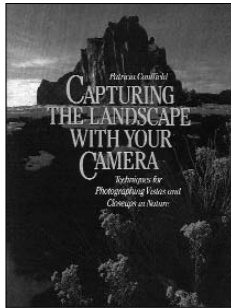

### **Capturing the Landscape With Your Camera**

by Patricia Caulfield

Beautiful full-color photographs show how to approach the landscape in step-by-step examples. Covers issues from cameras and lenses to composition. Includes appendices to national parks and nature preserves. 160 pgs.

Item # AMCLYC.....22.50

### **The Field Guide To Photographing Landscapes**

by Allen Rokach and Anne Millman

Illustrated with color photos of breathtaking landscapes, this guide examines the criteria of creating seasonal portraits, capturing texture, shooting mountains—as well as shooting at night. 128 pgs.

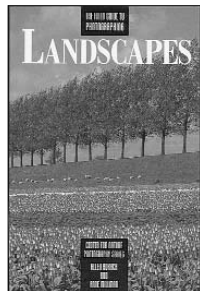

Item # AMFGPLS.....16.95

### **National Geographic Photography Field Guide Landscapes**

by Robert Caputo

Learn to compose and photograph the lay of the land at its breathtaking best, whether it is the Grand Canyon or the backyard garden. Tips on taking great photographs in awful weather to gauging the best time of day to get the best light for different subjects.

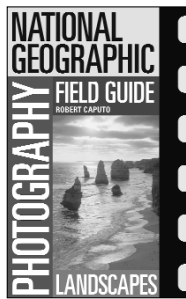

Item # AMNGPGL.....21.95

### **Light and the Art of Landscape Photography**

by Joe Cornish

foreword by Charlie Waite

A rarely-seen glimpse into the art and creative genius of one of the UK's most distinguished landscape photographers, with explanations of the creative inspiration behind each of his magnificent photographs. 160 pgs.

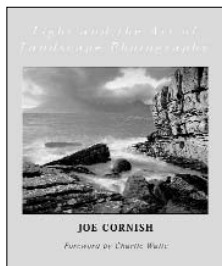

Item # AMLALP.....29.95



### **Creative Landscape Photography**

by Niall Benvie

Illustrated with 200 extraordinary practical pointers and tested techniques for photographing landscapes, from epic panoramas to intimate details of nature. A section on digital equipment, finishing, and output. 160 pgs.

Item # AMCLPQ.....29.95

### **John Shaw's Landscape Photography**

by John Shaw

A master photographer offers a wonderful guide for all landscape photographers. He provides basic information on film and exposure, plus offers tips on problems like lens flare. 144 pgs.

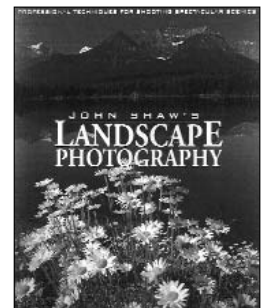

Item # AMJSLP.....24.95

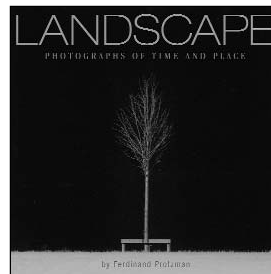

### **Landscape Photographs of Time and Place**

by Ferdinand Protzman

A first and only book of its kind. The most exquisite and dramatic landscape photographs ever taken are explored for the enduring and changing themes behind them. An indispensable and truly extraordinary book — thought provoking and visually stunning. 168 pgs.

Item # AML.....50.00

### **Michael Busselle's Guide to Photographing Landscapes and Gardens**

by Michael Buselle

From the intimacy of peaceful gardens to the spectacle of dramatic landscapes, coastal scenes, mountains, lakes, rivers and waterfalls, Busselle explains the use colour, light and composition to create stunning, atmospheric images. A must have guide. 206 pgs.

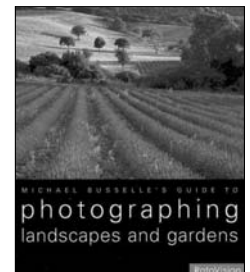

Item # ROPLG.....22.95



EQUIPMENT LEASING AVAILABLE

# LIBRARY

## LANDSCAPE

LIBRARY

659



### The World's Top Photographers Landscape

by Terry Hope

A 'must-have' for amateurs and professionals alike, this elegant collection brings together the most impressive landscape shots by the world's most acclaimed professionals. Featuring the work of such luminaries as Charlie Waite, Galen Rowell, Michael Busselle,

and other top photographers. 176 pgs.

Item # ROWTPL .....34.95

### America From The Air

by Robert J. Moore, Jr.

See the grandeur and the variety of the American landscape from high above. Hundreds of oversized spectacular photographs create a fascinating virtual tour of 50 states from a vantage point few of us have shared. Region by region, manmade achievements and sights of natural beauty come into view. 304 pgs.

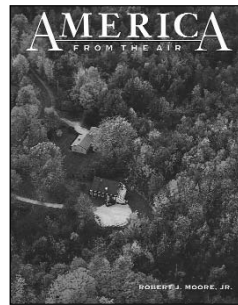

Item # STAFTA .....19.98

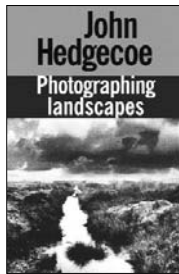

### Photographing Landscapes

by John Hedgecoe

Every photographer who gazes upon majestic, snow-capped mountains, a lush green countryside, or a colorful tapestry of autumn leaves instantly reaches for the camera, hoping to capture every nuance of the remarkable scene. Using over 300 photos as examples, world-renowned photographer John Hedgecoe discusses equipment, photographic controls, and natural factors that shape the landscape. A masterful guide. 160 pgs.

Item # STJHPL .....17.95

### Infrared Landscape Photography

by Todd Damiano

Landscapes shot with infrared can become breathtaking. This professional photographer has shot throughout the picturesque deserts of California, New Mexico and Arizona and analyzes over fifty of his compelling images for infrared techniques, composition and lighting. 128 pgs.

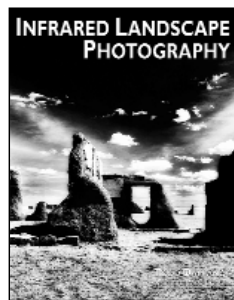

Item # AMILP .....29.95

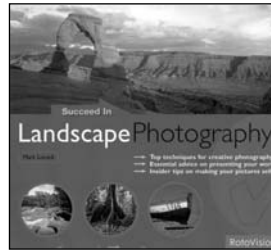

### Succeed In Landscape Photography

by Mark Lucock

Insight into the daily life and decision-making of the working landscape photographer. The author, a professional landscape photographer, divulges trade secrets of producing successful commercial and fine art photography, and offers inspiration to others in their own landscape image-making. 128 pgs.

Item # ROLPQ .....24.95

### Landscapes

by William Cheung

Excellent images, accompanied by detailed and fascinating commentary. Several top photographers reveal their artistic secrets, explaining what they saw, how they visualized the picture, and how they dealt with technical aspects like exposure, filters, and composition to get the best possible results. 128 pgs.

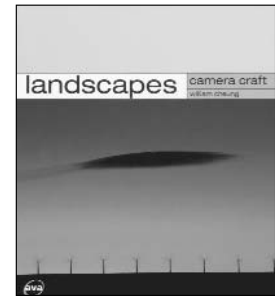

Item # STL .....24.95

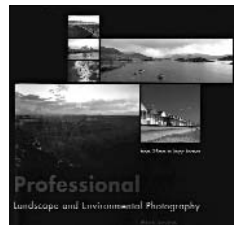

### Professional Landscape and Environmental Photography

by Mark Lucock

Photographers can capture the magnificence of any landscape, natural or urban—from rainforests to rocks and mountains, grasslands to the concrete jungle. Dozens of exquisite examples of professional work. All the information you need to acquire a better understanding of the magical craft of environmental photography. 192 pgs.

Item # STPLEP .....29.95

### Photographing Creative Landscapes

Simple Tools for Artistic Images and Enhanced Creativity

by Michael Orton

Michael Orton's photos are sold worldwide and have been used in corporate advertising, TV and video, magazines, books, and as lithographed fine art prints. 80 full color photos. 128 pgs.

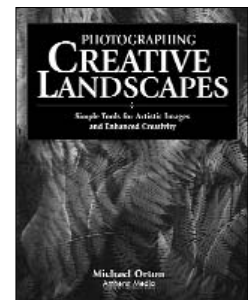

Item # AMPCL .....29.95

ORDER & INFO. (212) 502-6340 • FAX: (212) 239-7770 (800) 947-7008  
1-800-290-6750 • www.bhphotovideo.com



# LIBRARY

## LANDSCAPE

LIBRARY

660

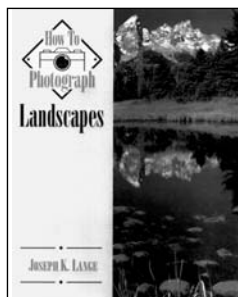

### How to Photograph Landscapes

by Joseph K. Lange

An award-winning photographer gives detailed, how-to information on both the technical and artistic aspects of landscape photography. Lange, master of dramatic lighting and composition, presents a clear, straightforward system for recognizing, composing, and shooting memorable landscapes. 144 pgs.

Item # STHPL.....19.95

### Field Guide to Photographing Landscapes

by Charlie Waite

Everything you have to know to make great pictures of landscapes each time you shoot. Covers all the essentials you need to improve your skills. This helpful guide, complete with stunning landscape photographs and an easy-to-understand text, belongs in every nature photographer's camera bag. 128 pgs.

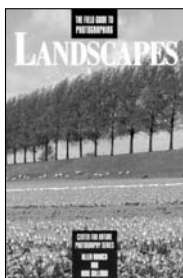

Item # AMFGPLS.....16.95

### Secrets of Successful Aerial Photography

by Richard Eller

Learn how to plan for every aspect of a shoot and take the best possible images from the air. Discover how to control camera movement, compensate for environmental conditions and compose outstanding aerial images. Over 100 color and b&w photos. 120 pgs.

Item # AMSSAP .....29.95

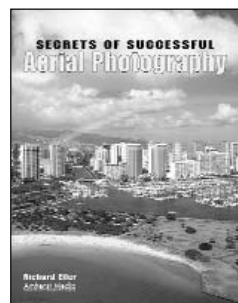

### Photography On Location

by Charlie Waite

A real master of landscape photography at work. Filled with remarkable images, this special collection of more than 30 fascinating articles from Outdoor Photography's popular "On Location" series follows this world renowned photographer as he visits a range of locations from mountains to castles to coastlines. 144 pgs.

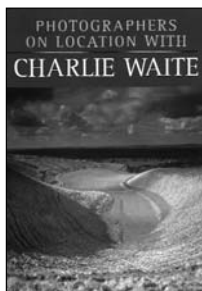

Item # STPLCW .....19.95

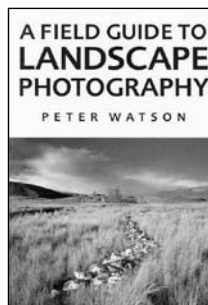

### A Field Guide to Landscape Photography

by Peter Watson

The most crucial element of a beautiful nature photograph is you, the photographer. Dozens of tips and tricks, from composition to technical considerations. Make the most of light and color, and overcome problems such as bad weather and mist. Pinpoint the best opportunities for success! 96 pgs.

Item # STFGLP.....14.95

### Better Picture Guide to Landscape Photography

by Michael Busselle

Capture coastline, mountains, lakes, rivers, waterfalls, skies, and horizons on film. This clear guide is for beginner as well as experienced landscape photographers. Expert guidance on how to use nature's shapes and patterns, the best times of day to capture light and texture, and much more. 128 pgs.



Item # ROBGPL .....19.95

### Photographing Changing Light A Guide for Landscape Photographers

by Ken Scott



The author explains his own unique approach to shooting landscapes, demonstrated in multiple images and detailed captions. His magnificent pictures show the ever-changing outdoors, where variations in light, weather, season and time of day all have a dramatic impact on how we perceive a scene. 168 pgs.

Item # STPLCG .....29.95

### Black & White Landscape Photography

by John Collett and David Collett

Learn the art of black and white landscape photography. Features selecting equipment, evaluating composition, shooting in the field, using the Zone system, and printing techniques for dramatic professional results. 128 pgs.

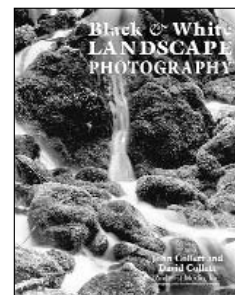

Item # AMBWLPL .....29.95



# LIBRARY

## YOU'RE ALL WET

LIBRARY

661

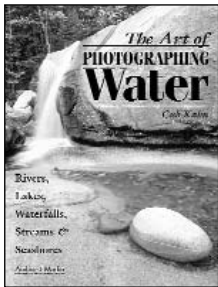

### The Art Of Photographing Water by Cub Kahn

This book is designed as a guide to field techniques and is sure to be a source of inspiration for outdoor enthusiasts of all abilities, ages and experience levels who are interested in landscape and nature photography. Includes photography techniques, equipment and information on composition. 128 pgs.

Item # AMAPW.....29.95

### The New Guide to Sea & Sea

by Joe Librua & Cara Sherman

A revised and updated successor to the Complete Guide to Sea & Sea, this encyclopedic reference for all underwater photographers has everything you need to know to produce professional quality images, starting with a thorough, easy to understand Photo Course. Step-by-step instructions in a how-to manual for all skill levels. 335 pgs.



Item # SEBNGSS.....24.95

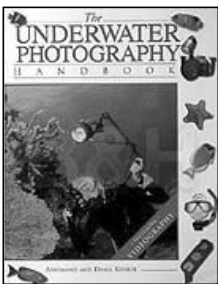

### The Underwater Photography Handbook

by Annemarie & Danja Kohler

Still photography and videography techniques, choosing the best equipment, using equipment to its full potential and solving technical challenges. Full-color diagrams, tables, and charts provide easy reference for exposure settings and composition. 200 color photos, 15 color drawings. 160 pgs.

Item # STUWPHB.....21.95

### How to Photograph Water

by Heather Angel

Reflections on a still pond, waves along a rocky coastline, mist shrouding a forest clearing, ice coating the branches of a tree. Capturing water on film can be a challenge. In clear detail and with a wealth of color photos, an expert shows you how to recognize great water shots. Includes a gallery of her most stunning scenes. 144 pgs.

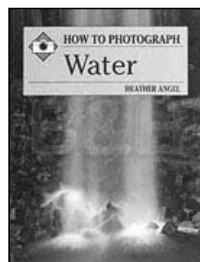

Item # STHPW.....19.95

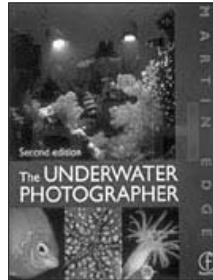

### The Underwater Photographer

2nd Edition

by Martin Edge

This popular manual, written by an experienced teacher of underwater photography and illustrated in color, demonstrates how to take stunning underwater photographs. Its clear, non-technical style makes it an indispensable guide to photographing the

wonders of the underwater world. 234 pgs.

Item # FOUWP.....44.95

### How to Photograph Underwater

by Norbert Wu

Discover the unlimited wealth of color and diversity of life under water. This book teaches the principles of lighting and positioning using the new, easier-to-use equipment which has the potential to make underwater photography almost fool-proof. Learn to take beautiful photographs correctly under water. 128 pgs.



Item # STHPUW.....16.95

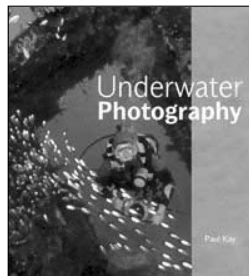

### Underwater Photography

by Paul Kay

An award-winning photographer and his breathtaking pictures provide beautiful inspiration. Dive into the deep blue sea and record the wonders of marine life. Capture the ocean's infinite splendor with an array of underwater shooting techniques. Suggestions on choosing a camera, maintaining the equipment, and lighting instructions in the watery world. 192 pgs.

Item # STUP.....29.95

### Successful Underwater Photography

by Brian Skerry and Howard Hall

Two top marine photographers provide no-nonsense tips for taking available-light photographs, silhouettes, marine wildlife portraits, close-focus and wide-angle photos. Page after page of dazzling underwater photography. 70 color, 35 b&w, 30 duotone. 144 pgs.

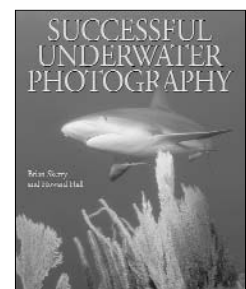

Item # AMSUP.....24.95

ORDER & INFO. (212) 502-6340 • FAX: (212) 239-7770 (800) 947-7008  
1-800-290-6750 • www.bhphotovideo.com



# LIBRARY

## CREATIVE CAREER

LIBRARY

662



### **The Art and Techniques of Business Portrait Photography**

by Andre Amyot

This unique book begins with an overview of the business skills you'll need to achieve success. With discussions on everything from finding a niche, to pricing your portraits, to advertising and even hiring a great assistant, every business/marketing angle is covered. You will be taking exceptional pictures. 128 pgs.

Item # AMATBPP.....29.95

### **The Art and Business of Photo Editing Selecting and Evaluating for Images Publication**

by Bob Shepherd

Learn the whys and shows of fine-tuning your images. Features lessons on balance, patterns and order; composition; subject emphasis techniques; targeting your images for the right market; evaluating a photo's technical merits. 128 pgs.

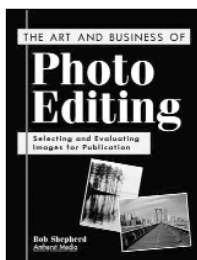

Item # AMABPE.....29.95

### **Power Marketing for Wedding and Portrait Photographers**

by Mitche Graf

Learn to identify your strengths as a photographer and develop a marketing plan that allows you to achieve your financial, artistic, and personal goals. With page after page of sage advice from the author and other industry leaders, this book is perfect for those new to the field and those photographers who want to improve an existing business. 128 pgs.

Item # AMPMWPP.....29.95



### **Interior Photography Lighting And Other Professional Techniques With Style**

by Eric Roth

A comprehensive overview, written by a practicing master in the field, on shooting interior photography professionally for artistic, technical, and financial success. Focuses on all the techniques needed to achieve success, including lighting, location, props, and styling. 160 pgs.

Item # AMIP.....29.95

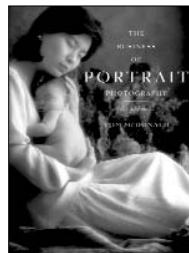
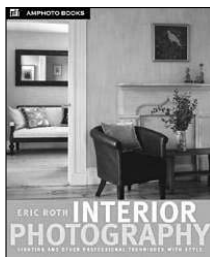

### **The Business of Portrait Photography**

by Tom McDonald, Revised Edition

Portrait photography is one of the largest—and most lucrative—specialties in photography. This comprehensive career guide offers all the tools, techniques and tactics needed to open a successful portrait studio or make a current studio even more profitable. Business strategies; photographic secrets for surviving and thriving in this competitive field; dozens of topics; stunning photos. 192 pgs.

Item # AMBPP .....29.95

### **The Photographer's Market Guide to Photo Submission and Portfolio Formats**

by Michael Willins

Detailed examples guide the photo entrepreneur through the photo submission and selling maze. 160 pgs.

Item # FWPMPs .....18.95

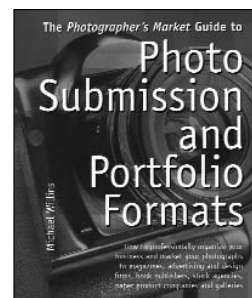

### **Stock Photography Professional Techniques and Images**

by Ulrike Welsch

Renowned stock photographer Ulrike Welsch teaches you how to take the images that will find a market in the highly competitive world of stock photography. Covers: travel tips, composition, selecting subjects, and defining your market. The author's stock photography images have appeared in Smithsonian, Time, World Paper, and Yankee, as well as in numerous textbooks. 120 pgs.

Item # AMSPQ.....29.95

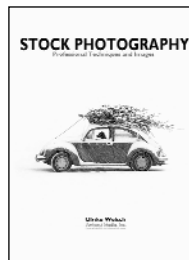

### **Portfolios That Sell Professional Techniques for Presenting and Marketing Your Photographs**

by Selina Oppenheim

The ultimate guide for creating an effective portfolio that will get the attention of any potential client. Includes no-fail tips for marketing, self-promotion, client relationships, and more. 144 pgs.

Item # AMPSK .....29.95

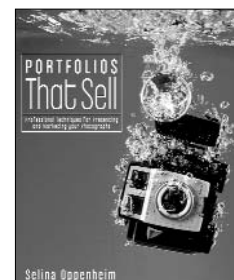

For Any Inquiries Regarding Your Order, Call Our Customer Service:  
(800) 221-5743 • (212) 239-7765 • FAX: (800) 947-2215 • (212) 239-7549

# LIBRARY

## CREATIVE CAREER

LIBRARY

663

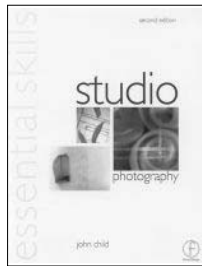

### Studio Photography

by John Child

Updated inspirational studio photography guide stimulates your creative ideas. Fully illustrated with brand new student and author work, a color section is included to show the photographic effects to their full advantage. Focuses on technique, communication and design within the genres of still life, advertising illustration, portraiture and fashion. Achieve acceptable results and develop your skills. 200 pgs.

Item # FOSPZ.....29.95

### Picture Editing

by Tom Ang

The art and discipline of picture editing and picture management. Provides a framework for understanding picture editing as a many-stranded and complex task. Techniques and technology, check-lists, glossary and exercises to help the student or trainee. It is illustrated with many photographs, including over forty color photographs in the plate section. 275 pgs.



Item # FOPE.....49.95

### Studio Lighting

A Primer for Photographers

by Lou Jacobs Jr.

If you're ready to delve into the world of studio photography and gain a better command over your images, this is the book for you. Whether you set up a temporary space in a living room or rent a commercial space, this guide will aid you in selecting equipment, maximizing your creativity, and fine-tuning your images—from still life to portraits. 128 pgs.



Item # AMSLPP.....29.95

### Selling Nature Photographs

by Norbert Wu

Selling nature photographs discusses in detail how to set up an office system, attract and maintain a good client base, market photographs and negotiate fees. Expert tips on composition and photography are offered as well. 75 color photos. 144 pgs.

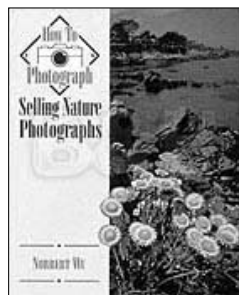

Item # STSNP.....18.95

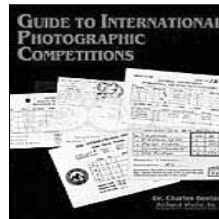

### Guide to International Photographic Competitions

by Dr. Charles Benton

Feedback and exposure from competition can help you improve and sell your photographs. Includes: scouting competitions, making submissions, how judging works and how to interpret and use your results. The author is a retired chemist from Eastman Kodak who has competed extensively in national and international photographic competition. 86 pgs.

Item # AMGIPC.....29.95

### Professional Marketing & Selling Techniques

for Wedding Photographers

by Jeff Hawkins and Kathleen Hawkins

Create, refine or restructure your wedding portrait business. Achieve your financial goals with professional sales techniques. Includes online marketing, bridal shows, direct mail campaigns, ideas for special promotions, sample business forms and advertisements. 128 pgs.

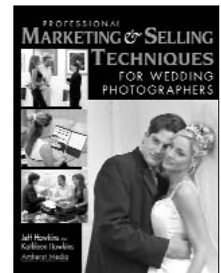

Item # AMPMSTWP.....29.95

### Photographers and Their Studios

by Helen Boursier

Learn how to create a beautiful and profitable studio. Explore the studios of twenty top photographers from around the world, and examine the problems each faced as well as the solutions they devised. Includes consultation and viewing rooms, bathrooms, location scouting, production areas, storage space, and more. 120 pgs.

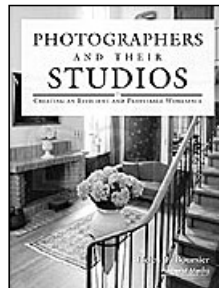

Item # AMPTSQ.....29.95

### Shooting & Selling Your Photos

by Jim Zuckerman

Combines beautiful show-and-tell photography. Authoritative instruction, updated technological information and complete coverage on breaking into today's photography market. The book is divided into 3 parts: "Shooting," "Building Your Image" and "Selling." Offers everything readers need to get serious about their photography. 144 pgs.

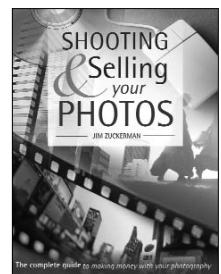

Item # FWSSYP.....27.95

ORDER & INFO. (212) 502-6340 • FAX: (212) 239-7770 (800) 947-7008  
1-800-290-6750 • www.bhphotovideo.com



# LIBRARY

## A BUSINESS POINT OF VIEW

LIBRARY

664

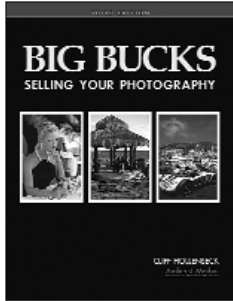

### **Big Bucks** **Selling Your Photography** by Cliff Hollenbeck

Comprehensive business guide to selling photography. Renowned West Coast photographer Cliff Hollenbeck teaches his successful photo business plan. Features setting financial, marketing and creative goals. Plus much more. Now updated with new information on digital photography and the Internet. 144 pgs.

Item # AMBBSYP.....17.95

### **The Photojournalist's** **Guide to Making Money** by Michael H. Sedge

Expert research and first-rate resources take experienced photojournalists to new heights of success, while showing aspiring photojournalists how to begin their climb in a stimulating and rewarding field. Establish a business, implement the latest research tactics, network with editors, pitch to television producers, and expand business through lectures and teaching. 224 pgs.

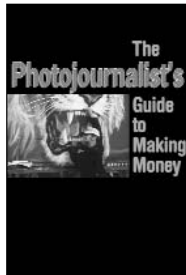

Item # AMPGMM.....18.95

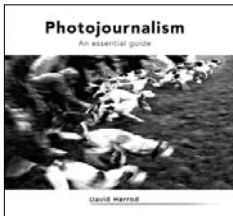

### **Photojournalism** **An Essential Guide** by David Herrod

In this beautifully presented collection, one of the finest photojournalists working today shares his technical and aesthetic approach to the art. The subjects are diverse and fascinating:

hunting dogs in action; a jazz festival; a bicycle rider who's taken a tumble; an auction and children in special education classes. The moments are captured with clarity and emotion. 180 pgs.

Item # STPEG.....24.95

### **The Business of Studio** **Photography** by Edward R. Lilley

Portrait and wedding photographers will find scores of proven-effective strategies for starting a new studio or improving an existing one. Practical advice and surefire strategies for every aspect of operating a photography studio: from choosing a location, financing, and equipping the business to pricing jobs, negotiating with photo labs, and selling to the public. 336 pgs.

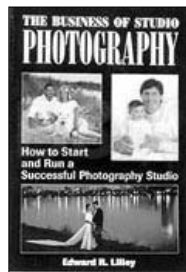

Item # AMBSP.....19.95

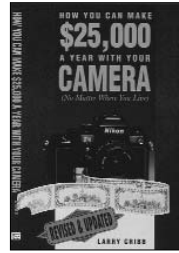

### **How You Can Make \$25,000** **a Year** **With Your Camera** by Larry Cribb, Revised & Updated

This great book for beginners offers score of ideas for photographers who want to sell photographs in their own communities. Readers will learn what it takes to supplement their income, or even make a living as a photographer without having a studio and without a great deal of expensive equipment. Includes great ideas on where to find business. 224 pgs.

Item # FWHYCM25MC.....17.95

### **Taking Pictures for Profit** by Lee Frost

A successful freelance photographer provides the artistic, marketing and financial basics one needs to turn talent into cash — and an enjoyable hobby into a profitable business. Frost covers the different markets for photographic services, copyright, money matters, and self-promotion and shows you how to market your images and sell your original work. 160 pgs.

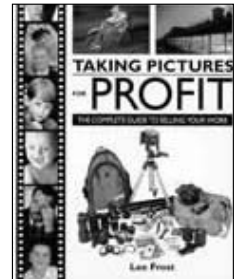

Item # FWTTP .....19.95

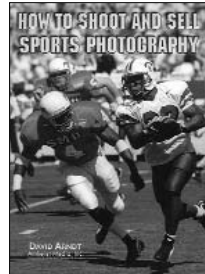

### **How to Shoot and Sell** **Sports Photography** by David Neil Amdt

A complete guide to success in the business of sports photography. Create the best possible images and market them for repeated sales. Learn how to study a team before the game, how to work with clients, and customizing your portfolio to get noticed. This book provides a comprehensive study of the many facets of photographing sports events. 120 pgs.

Item # AMHSSSP.....29.95

### **Business of Nature** **Photography**

**A Professional's Guide to Marketing and Managing a Successful Nature Photography Business**  
by John Shaw

A best-selling author shares the kinds of pictures that sell; effective marketing; legal, financial and rights issues; equipment, computers and software; and invoicing. Pictures by exceptional amateur photographers and instructional text. 144 pgs.

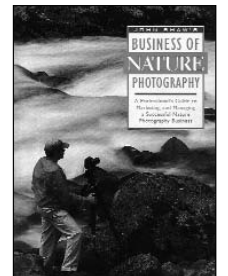

Item # AMJSBNP.....35.00



For Any Inquiries Regarding Your Order, Call Our Customer Service:  
(800) 221-5743 • (212) 239-7765 • FAX: (800) 947-2215 • (212) 239-7549



# LIBRARY

## A BUSINESS POINT OF VIEW

LIBRARY

665

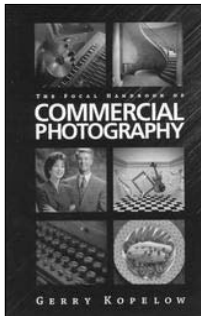

### The Focal Handbook of Commercial Photography

by Gerry Kopelow

A contemporary and pragmatic guide to professional practice and career planning that will help both the aspiring and established photographer make appropriate choices in the face of the ongoing changes in this industry. Many practical hints on making more money in less time with less effort. 386 pgs.

Item # FOFHBCP.....44.95

### Photographers Market Guide to Building Your Photography Business

by Vik Orenstein

The guide is for amateurs seeking a friendly overview of the business, established photographers delving into a new niche, freelancers interested in selling stock, and photographers starting their own studio. Big-picture thinking with a soft touch delivers practical and sound advice. 320 pgs.

Item # FWGBYPB.....18.95

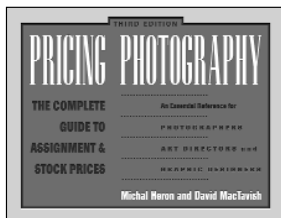
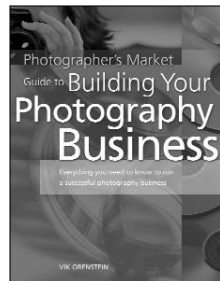

### Pricing Photography

The Complete Guide to  
Assignment and Stock Prices

by Michal Heron &  
David MacTavish  
3rd Edition

This classic guide provides a wealth of time-tested information on estimating prices, negotiating deals, and much more! New edition features updated pricing charts, a buyer's guide, and dozens of ready-to-use forms and checklists. 160 pgs.

Item # AMPPR.....24.95

### The Photographer's Guide to Negotiating

by Richard Weisgrau

Negotiating is crucial for anyone running a business, but they don't teach it in photography school. Get tips for negotiating assignment deals, digital and electronic rights, stock photography sales, contracts, purchases, and more. Interviews with an art buyer, a photographer, and a photographer's rep will give you insight and the upper hand in many negotiations. 256 pgs.

Item # AMPGN.....19.95

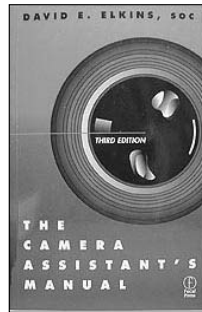
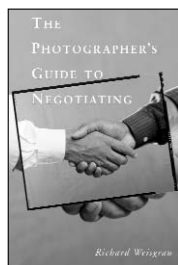

### The Camera Assistant's Manual

by David Elkins

A nuts and bolts guide for beginning camera assistants and film students. Information on all aspects of this unique position within the film industry—from cinematography basics to interviewing for the job. Also features an expanded camera section, which lists and illustrates new cameras, as well as specialized camera and lens accessories. 416 pgs.

Item # FOCAM.....39.95

### Talking Photography

Viewpoints on the  
Art, Craft and Business

by Frank Van Riper

An award-winning columnist presents his expert answers to basic, yet rarely addressed technical questions—from shooting pictures under fluorescent light to defending yourself against mosquitoes. Also features captivating interviews with industry icons. 288 pgs.

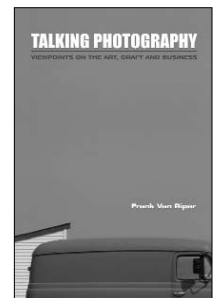

Item # AMTPX.....19.95

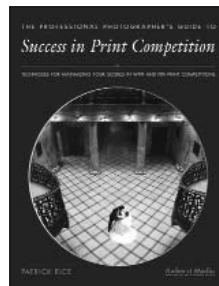

### Success in Print Competition

by Patrick Rice

People seek success more passionately when their efforts are being evaluated. In this book, you'll learn how competition can benefit you both creatively and professionally, helping you to generate better images, attract more clients, and earn the respect of other professionals. 128 pgs.

Item # AMSPCQ.....29.95

### Photography Your Way

A Career Guide  
to Satisfaction and Success

by Chuck DeLaney

Rich with seasoned advice and practical tools for conquering fears behind the camera, this is a motivational guide for anyone wanting to advance in the world of photography as a career or hobby. The author outlines career avenues and options. 256 pgs.

Item # AMPYW.....18.95

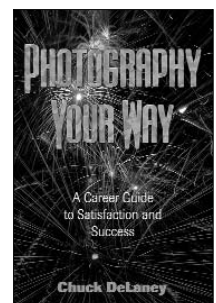

# LIBRARY

## CAREER ADVICE

LIBRARY

666

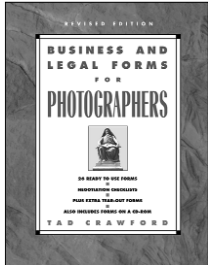

### **Business and Legal Forms for Photographers**

by Tad Crawford  
3rd Edition

Updated to cover electronic rights, this collection of essential forms and negotiation tactics will meet every need on the business end of the photographer's work. Includes a CD-ROM with electronic versions of every form you could possibly need – making this

an indispensable tool for photographers. 180 pgs.

Item # AMLBFP .....29.95

### **Starting Your Career as a Freelance Photographer**

by Tad Crawford

A virtual treasury of advice, insight and guidance for every freelance photographer! Provides crucial marketing, business, and legal know-how for every step of the process — from creating a portfolio and promoting your work, to winning the first client and running a healthy, profitable business. 256 pgs.



Item # AMSCFP .....19.95

### **2005 Photographer's Market**

by Donna Poehner

Provides photographers with the key guidelines they need to sell their work and build a career. Provides: 2000 listings covering every possible opportunity, including magazines, stock agencies, ad firms, book publishers, newspapers, businesses, galleries, and art fairs; Fresh business advice and new information on how to break into book publishing markets. 640 pgs.

Item # FWPM2005.....24.95

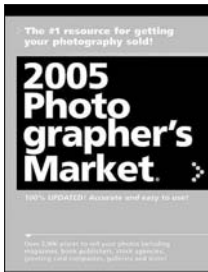

### **The Big Picture**

**The Pro Photographer's Rights, Rates & Negotiation**

by Lou Jacobs

Running your own photography business in today's market demands the savvy and insight contained in this indispensable guide. Sample forms, contracts, letters, estimates and formulas will help you negotiate and increase your potential revenue. Grow your talent into a highly successful career. 218 pgs.



Item # FWBPPPR.....17.95

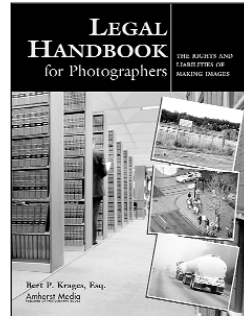

### **Legal Handbook for Photographers**

**The Rights and Liabilities of Making Images**

by Bert P. Krages, Esq.

From photographing on private property or crime scenes, to dealing with film or equipment seizures, Krages offers readers solid advice that will help them make well-informed decisions. 128 pgs.

Item # AMLHBP .....19.95

### **Stock Photography Business Forms**

**Everything You Need to Succeed in Stock Photography**

by Michal Heron

This complete set of forms has everything a photographer needs to run and organize a stock photography business. Step-by-step instructions and helpful advice accompany forms to organize shoots, travel, resources, clients, markets, and to manage every detail of day-to-day operation. 144 pgs.

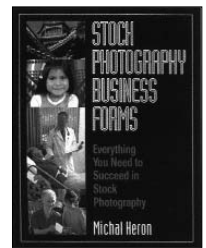

Item # AMSPBF .....18.95

### **Wedding and Portrait Photographer's Legal Handbook**

by Norman Phillips, Christopher S. Nudo

Capturing images of once-in-a-lifetime events like weddings, bar mitzvahs, and other special occasions can leave you vulnerable to a host of legal problems. This book gives advice to protect yourself against legal action and how to proceed if you find yourself in such a position. Contains 25 sample forms. 125 pgs.

Item # AMWPPLHB .....29.95

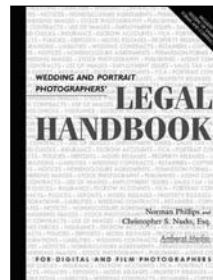

### **Law and Order**

**Crime Scenes**

by Dick Wolf  
Photographs

by Jessica Burnstein

A visually powerful look at the show, featuring gritty crime scene photographs from the most popular episodes.

Anatomies of each crime scene, interviews and glimpses behind the scenes makes this a must-have. 160 pgs.

Item # STLO.....14.95

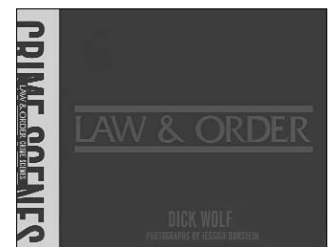

For Any Inquiries Regarding Your Order, Call Our Customer Service:  
(800) 221-5743 • (212) 239-7765 • FAX: (800) 947-2215 • (212) 239-7549

# LIBRARY

## CAREER ADVICE

### **Freelance Photographer's Handbook**

by Cliff and Nancy Hollenbeck

Learn the ins and outs of freelance photography. Choosing equipment, starting a business, selecting marketable subjects, preparing sales proposals; photojournalism, stock, travel, and more. The authors specialize in editorial and commercial image making and have received gold medals at film festivals in Chicago and New York. 112 pgs.

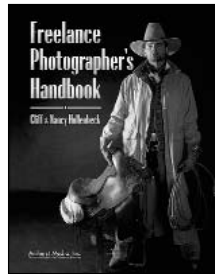

Item # AMFPHB .....29.95

### **How to Buy and Sell Used Cameras**

by David Neil Arndt

Learn to test camera and lens functions, and evaluate their overall conditions to make the smartest buying or selling decisions every time. Discover what to look for, where to look and how to get the price you want. David Neil Arndt is a professional photographer and writer. Hundreds of his images have been distributed worldwide by the Associated Press and United Press International. 112 pgs.

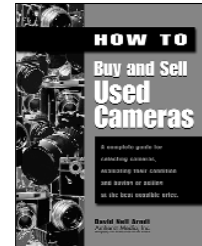

Item # AMBSUC .....19.95

### **Selling Photography**

by Roger Antrobus

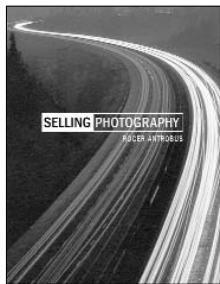

A picture may be worth a thousand words. But in his straightforward approach to the fine art of selling photography, author and professional photographer, Roger Antrobus, explains how a picture can also be worth thousands of dollars—provides practical answers to the questions every photographer asks when making the move from amateur to professional. 128 pgs.

Item # AMSPZ .....24.95

### **Successful Self-Promotion for Photographers**

Expose Yourself Properly

by Elyse Weissberg & Amanda Sosa

There's more to being a professional photographer than taking great pictures. Today's self-employed photographers must have marketing savvy to spare. This guide teaches freelance photographers what to do after the pictures have been developed. 160 pgs.

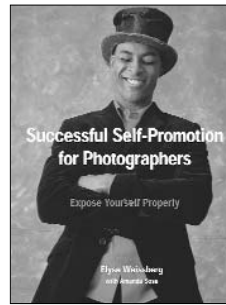

Item # AMSSPSP .....29.95

### **Sell & Resell Your Photos**

by Ron Engh, 5th Edition

The picture you make today can sell again and again. This guide covers everything from choosing a subject to marketing your photos the right way — to the right people. Dozens of photos, charts, tables and sidebars that help focus your goals and improve your profit picture. All the information you need to master the stock photography market. 374 pgs.

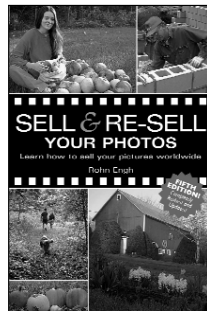

Item # FWSRYP .....19.95

### **Photos That Sell**

The Art of Successful Freelance Photography

by Lee Frost

Actually two books in one, this guide not only shows photographers—and those aspiring to be—how to snap great commercial photos, but also offers hundreds of success tips for selling them in the marketplace. Demonstrates how to snap great commercial photos. 192 pgs.

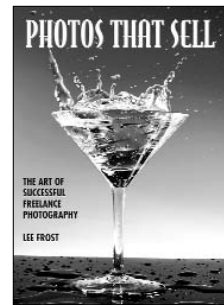

Item # AMPTS .....24.95

### **Photography: Focus On Profit**

by Tom Zimberoff

An all-in-one reference to conquering the photography business. Hundreds of time-proven procedures for making a profit and the software (CD-ROM included) to do it. This no-fail guide details the "best practices" for starting, running, and evaluating the ongoing operation of a photography business. 416 pgs.

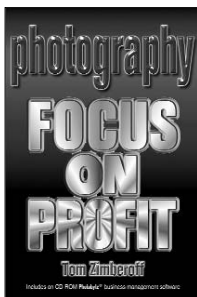

Item # AMPPP .....34.95

### **How to Shoot Stock Photos That Sell**

### **How to Shoot Stock Photos That Sell**

by Michal Heron, 3rd Edition

Written by a leader in the world of stock photography, this completely revised and updated edition provides practical, detailed advice on every area of producing, marketing, and selling stock photography—from the basics of planning and producing a shoot to running a successful stock business. 224 pgs.



Item # AMHTSSPTS .....19.95

LIBRARY

667

# LIBRARY

## IN THE DARK

LIBRARY

668

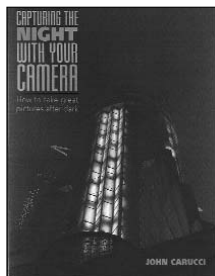

### **Capture the Night** How to Take Great Pictures After Dark

by John Carucci

Every photographer tries to shoot at night, when subjects seem mysterious and magical. Different nighttime lighting conditions can pose quite a challenge. This book takes the mystery out of night photography. A first step-by-step guide to focus on photographing at night, not just in low light. 144 pgs.

Item # AMCNYC.....24.95

### **Night Photography** Honorable Mention in the 2002 Golden Light Award Committee by Andrew Sanderson

This uniquely accessible guide unlocks the mysteries of how to attain stark, beautiful images after dark. Detailed, practical advice on film speeds, reciprocity failure, street lighting, exposure control, contrast and tone, and much more. Clear, simple step-by-step instructions. Over 150 stunning photographs. 128 pgs.

Item # AMNP.....29.95

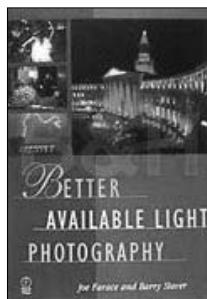
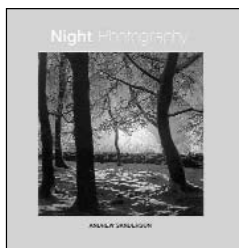

### **Better Available Light Photography**

by Joe Farace and Barry Staver

Learn to understand the different kinds of lighting challenges that exist and how to overcome them in order to create great photographs. For the amateur or aspiring professional who is looking to discover the joys of creating useful images when photographic conditions are at their most difficult. 156 pgs.

Item # FOBALP.....33.95

### **The Photographer's Guide To Using Light**

by Ted Schwarz and Brian Stoppee

Learn to apply theory to reality. Bridging the gap between theory and application, this guide provides a practical course on one of photography's most important subjects. Specifically designed to help photographers understand the basic principles of lighting, as pertains to the reality of everyday situations. 144 pgs.

Item # AMPGUL.....19.95

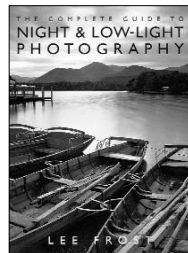
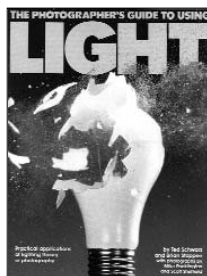

### **The Complete Guide to Night & Low-Light Photography**

by Lee Frost

With just a little skill and imagination, even amateurs can produce breathtaking photographs at night or in low-light settings. This guide tackles a wide range of themes and lighting situations, with specific guidance for shooting low-light landscapes, portraits, buildings, fireworks displays, lightning, sunrises, and sunsets. 192 pgs.

Item # AMCGNLP.....29.95

### **Photography at Night** Getting the Most from Low-Light Conditions

by Richard Newman

Night photography is an exciting challenge. All the normal rules of daylight photography are broken, and the extreme contrasts in light levels allow photographers to create dramatic and evocative images. More than just a standard photography manual, this is also a valuable teaching tool. Improve your low-light skills. 128 pgs.

Item # AMPAN.....24.95

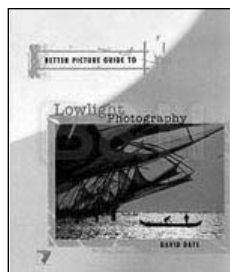
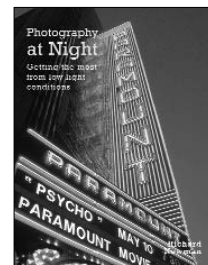

### **Better Picture Guide to Lowlight Photography**

by David Daye

Focuses on the built-in obstacles of low-light photography and how to overcome them. Learn how to maintain consistently accurate exposures, work with slow shutter speeds and achieve color accuracy with exposures that are measured in minutes. Stunning examples of indoor

and outdoor mixed-lighting conditions. 128 pgs.

Item # ROBPGLLP.....19.95

### **Secrets of Lighting on Location**

#### **A Photographer's Guide to Professional Lighting Techniques**

by Bob Krist

Solutions to the serious photographer's biggest challenge—on-site lighting dilemmas—are fully revealed and diagrammed in this book, illustrated with exciting assignment shots from locations around the world. 144 pgs.

Item # AMSLL.....24.95



EQUIPMENT LEASING AVAILABLE

# LIBRARY

## LIGHT AND EXPOSURE

LIBRARY

669

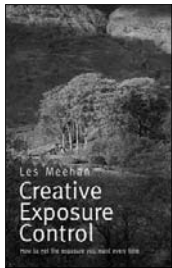

### **Creative Exposure Control** How to Get the Exposure You Want Every Time by Les Meehan

Clear, practical advice for giving creative control back to the photographer. Conveniently organized into three sections—Understanding Exposure, Assessing Exposure, and Controlling Exposure—from basic theory through such topics as metering systems and adjusting exposure in the camera, as well as the processing stage. 128 pgs.

Item # AMCEC.....24.95

### **Understanding Exposure** How to Shoot Great Photographs with a Film or Digital Camera Revised Edition

by Bryan Peterson, Revised Edition

More than 100 vivid, graphic comparison pictures illustrate every point. Special techniques explore such options as deliberate under- and overexposures, how to produce double exposures, bracketing, shooting the moon, and the use of filters.



Item # AMUE.....24.95

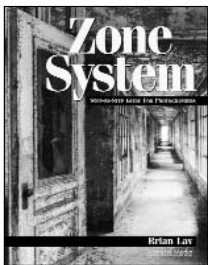

### **Zone System** Step-by-Step Guide for Photographers

by Brian Lav

Master the exposure and printing system used by Ansel Adams to create his masterpieces. Consummate educator and photographer Brian Lav provides easy, step-by-step instructions that make this often intimidating system simple to learn and apply. 100

duotone pictures. 128 pgs.

Item # AMZSSS.....29.95

### **Overexposure** Health Hazards in Photography

by Susan D. Shaw & Monona Rossol

An indispensable guide that covers all the risks faced by photographers, lab personnel, and others involved with photographic chemicals. Discusses health and safety; setting up a safe workplace; a review of harmful chemicals; health issues in conservation and restoration, and right-to-know laws. 320 pgs.

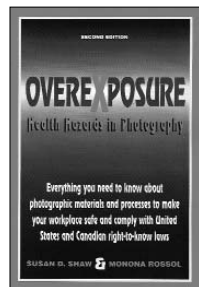

Item # AMOE.....18.95

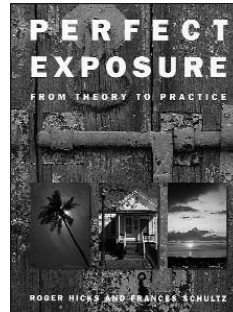

### **Perfect Exposure** From Theory to Practice by Roger Hicks and Frances Schultz

Exposure is one of the most demanding aspects of photography and not always easy to achieve. Acquire a thorough knowledge of theory, materials, processes and equipment. This comprehensive new book presents authoritative information on all aspects of exposure, both in theory and in practice. 192 pgs.

Item # AMPEZ.....29.95

### **The Photographer's Guide to Exposure**

Illustrated techniques for using your equipment effectively and creatively

by Jack Neubart

Subject made accessible and appealing. With side-by-side comparison shots throughout the book, Neubart tells you how to take the technically accurate shot and shows how to make the image even more striking by manipulating the exposure.

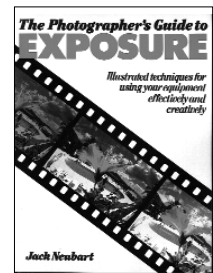

Item # AMPGE.....19.95

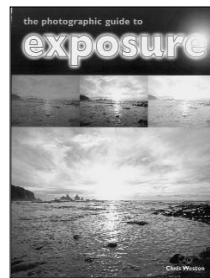

### **The Photographic Guide to Exposure**

by Chris Weston

Brilliant photographs, charts and graphics, the entire complex art of exposure is "exposed" and stripped down. Dozens of questions about the process are answered. Discover how different exposure meters work; control camera functions for good exposure; cope with difficult lighting

conditions; use exposure to create mood, and much more. 176 pgs.

Item # STPGE.....24.95

### **Perfect Exposure** Secrets to Great Photographs

by Jim Zuckerman

Even experienced photographers second-guess themselves when it comes to exposure. With hundreds of photographs that cover every lighting situation imaginable, this book trains photographers to recognize situations in which light meters will be ineffective, and then counsels them on how to deal with each situation. 82 pgs.

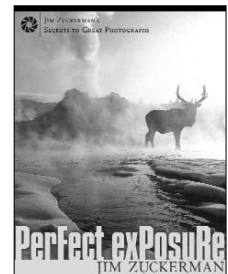

Item # FWPE.....27.95

# LIBRARY

## PORTRAITURE

LIBRARY

670

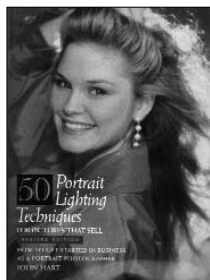

### **50 Portrait Lighting Techniques for Pictures That Sell**

by John Hart, Revised Edition

This revised best-seller features dozens of new strategies. Covers both studio and outdoor settings, this comprehensive text deals with the specialized area of lighting portrait photography. Attractive, easy-to-follow book on portrait lighting techniques that conveys author's love of photography as an art. 144 pgs.

Item # AM50PLT.....24.95

### **Master Posing Guide for Portrait Photographers**

A Complete Guide to Posing Singles, Couples and Groups

by J.D. Wacker

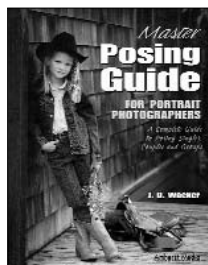

Improve your portraits. Discover what your client truly wants through a psychological approach to posing. Practical techniques are provided for every aspect of posing, beginning with the consultation and continuing on to dealing with a variety of different clients. 128 pgs.

Item # AMMPGPP.....29.95



### **The Portrait Professional Techniques and Practices in Portrait Photography**

by Eastman Kodak

Professional photographers discuss the art and practice of portrait photography. Experts, including Denis Reggie, Frank Cricchio, and Don Blair, offer guidance on equipment, lighting, exposure, weddings, specialty portraits, and more. 120 pgs.

Item # KOBP.....24.95

### **Portraits**

by Ann Henly

A good portrait captures and conveys a person's spirit. It can show the full face or focus on an eye, expressive hands, engaging smile, or out-of-focus turn of the head. Even the simplest camera can do the trick. A series of remarkable portraits, artistic and commercial, with tips and techniques to help you take an unforgettable photo. An unequalled education in portraiture! 128 pgs.



Item # STPQ.....24.95



### **The Best of Teen and Senior Portrait Photography**

by Bill Hurter

From yearbook advertisements, postcard mailings, and promotions to web site development and digital graduation announcements, every corner of the teen and senior portrait market is covered in this book of advice from the experts. Features artistry of top senior portrait experts. 128 pgs.

Item # AMBTSP.....29.95

### **The Lighting Cookbook Foolproof Recipes for Perfect Glamour, Portrait, Still Life, and Corporate Photographs**

by Jenni Bidner

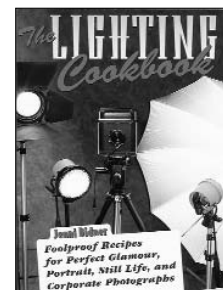

This bright new manual offers a smorgasbord of delicious ideas for studio lighting. Step-by-step lighting recipes, lighting diagrams, setup details, and lens choices—plus photos by top pros specializing in major areas of studio work. 144 pgs.

Item # AMLCB.....24.95

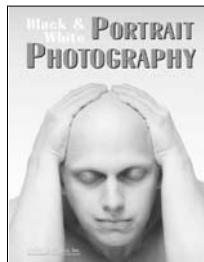

### **Black & White Portrait Photography**

by Helen Boursier

From the book: "Anyone who has ever watched a b&w movie on television, then switched to a color channel, can tell you that one medium is distinctly different from another. You must learn to see the world in b&w, and help your clients to do the same. Color film records form, while b&w film records contrast." 128 pgs.

Item # AMBWPPQ.....29.95

### **The Art and Techniques of Business Portrait Photography**

by Andre Amyo

Covers every business/marketing angle from finding a niche, to pricing portraits, to advertising and even hiring a great assistant. Also lighting tight spaces, ensuring a safe environment, shooting equipment, computers, etc. Thorough discussion of composition and lighting strategies employed. 12 pgs.



Item # AMATBPP.....29.95



EQUIPMENT LEASING AVAILABLE

# LIBRARY

## PORTRAITURE

LIBRARY

671

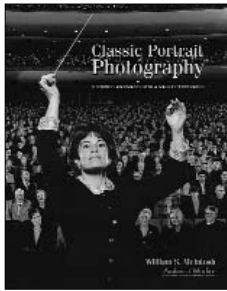

### **Classic Portrait Photography** Techniques and Images from a Master Photographer

Go behind the scenes and learn the techniques required to capture flawless images of portrait subjects in ever imaginable situation—from posing and lighting large groups, to orchestrating on-location shots that even the most discriminating client will cherish. 128 pgs.

Item # AMCPP .....29.95

### **National Geographic Photography Field Guide People & Portraits** by Robert Caputo

When's the right moment to snap a sunset? How do you "freeze" your child in action on the soccer field? What subjects photograph best in black and white? This information-packed guide answers these questions and more. Capture the spirit of important moments. 160 pgs.

Item # AMNGPG .....21.95

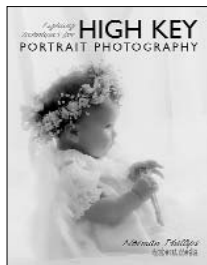
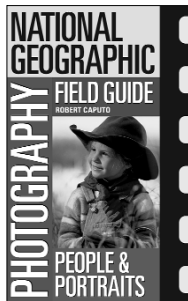

### **High Key Portrait Photography** by Norman Phillips

Master photographer Norman Phillips shows readers how to avoid common pitfalls to produce flattering high key portraiture. Readers will learn to recognize high key portraits, and to create this popular style in their own studios—or in their backyards. From metering for perfect exposures, to

achieving correct lighting ratios. 128 pgs.

Item # AMHKPP .....29.95

### **Lighting and Exposure Techniques for Outdoor and Location Portrait Photography** by J. J. Allen

The author takes you step-by-step through the techniques you need to succeed – from selecting portable equipment, to choosing a setting with good light. You'll learn to eliminate lighting and exposure problems and create flattering, consistent results on every shoot. 128 pgs.

Item # AMLLL .....29.95

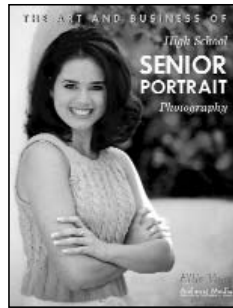
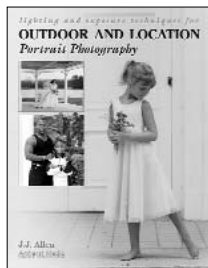

### **The Art and Business of High School Senior Portrait Photography** by Ellie Vayo

Insights and techniques on how to attract clients and create the unique portraits that will generate the best (and cheapest) advertising in the world: word of mouth. This new book covers all of the aspects of this challenging business. 128 pgs.

Item # AMABHSP .....29.95

### **Faces** The Creative Process Behind Great Portraits by Jane Brown

This book delivers exactly what its title promises—pictures of faces. Jane Brown has over 45 years practical experience as a professional portrait photographer. Working exclusively in black and white, using only natural light and one SLR camera, she has photographed many famous individuals. Here she reveals the secrets of her craft. 160 pgs.

Item # STF .....19.95

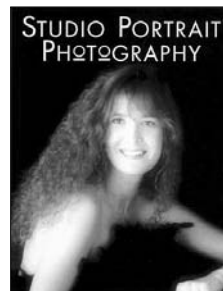
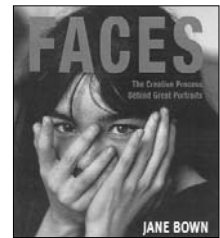

### **Studio Portrait Photography** A Guide to Classic Portrait Photography by Jonathan Hilton

More than a hundred top-quality portrait photographs. Explains how each was taken and highlight the basic points of composition, posing the subject, selecting the best camera angles and lenses, and how to set your lights. 160 pgs.

Item # ROPSP .....34.95

### **The Complete Idiot's Guide: Portrait Photography** by Kathleen Tracy

This is a practical manual that teaches all that is involved in creating portraits, step by step. It offers tips on poses, discusses lighting, makeup and framing, and even explains equipment purchasing — as well as maintenance. Can't get better (and simpler) than that. 360 pgs.

Item # PECIGPP .....19.75

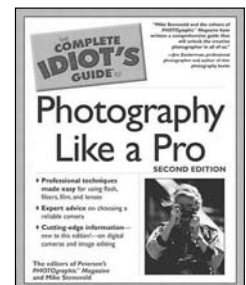

ORDER & INFO. (212) 502-6340 • FAX: (212) 239-7770 (800) 947-7008  
1-800-290-6750 • www.bhphotovideo.com





# LIBRARY

## PORTRAITURE

LIBRARY

672

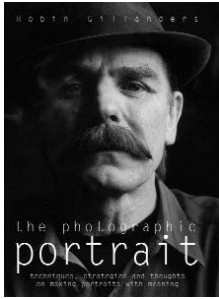

**Photographic Portrait:  
Techniques, Strategies  
and Thoughts on Making  
Portraits with Meaning**  
by Robin Gillanders

In this comprehensive work, celebrated portraitist and teacher Robin Gillanders explores the subject in depth. Looking at all kinds of portraiture in both color and black & white, he discusses in depth how to give portraits real meaning. 144 pgs.

Item # FWPP.....29.95

**The Portrait Book  
A Guide for Photographers**  
by Steven H. Begleiter

Professional photographers will increase the marketability of their images and achieve success with these tips for creating and marketing beautiful and unique portraits. Includes information that will help any photographer put his or her finger on the pulse of the editorial market's needs. 128 pgs.



Item # AMPB.....29.95

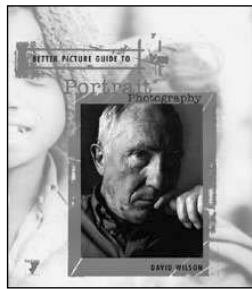

**Better Picture Guide to  
Portrait Photography**  
by David Wilson and David Daye

Effective lighting, composition, background, and techniques for portrait photography are fully explained in this great guide to great portraiture, which takes the reader through every stage of shooting a portrait—formal, informal, or candid shot. Detailed information on camera equipment. 120 pgs.

Item # ROBPQP.....19.95

**The Best of  
Portrait Photography**  
by Bill Hurter

This indispensable guide contains everything you need to know about posing, eliciting expressions, creating dynamic compositions, utilizing traditional lighting setups, and more. Practical, hard-won advice. The portfolio section offers an inside look at the working habits, styles and strategies of industry pros. 128 pgs.

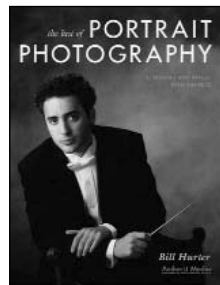

Item # AMBPPQ.....29.95

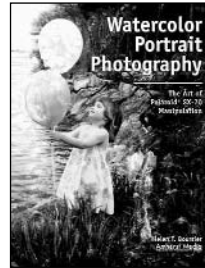

**The Field Guide to Photographing  
Watercolor Portrait  
Photography**  
by Helen Boursier

Learn to create painterly images by manipulating Polaroid SX-70 prints. Includes manipulation techniques, computer enhancements, marketing and much more. Helen Boursier has operated a portrait studio since 1983. She works exclusively with black and white portraits of families and children. 112 pgs.

Item # AMWPP.....29.95

**Professional Secrets of  
Natural Light Portrait  
Photography**  
by Douglas Allen Box

Learn to select the right setting, equipment, backdrop, and props, as well as how to control the balance of light between subject and background. Each sample portrait is accompanied by detailed technical information. Window, porch, shade, and all lighting types and situations are discussed in this step-by-step manual. 120 pgs.

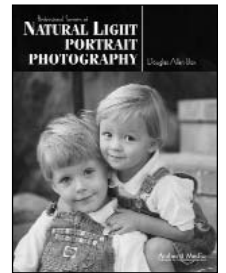

Item # AMPSNLPP.....29.95

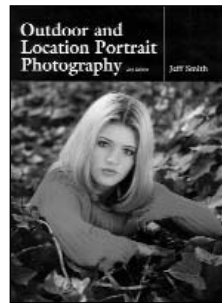

**Outdoor and Location  
Portrait Photography**  
by Jeff Smith

Complete guide to shooting outdoors and on location. Understand and control natural light, and select the perfect scene. Included are tips for posing, selecting clothing and marketing your work. The Right Equipment Selecting the Perfect Scene Elements of Style Marketing Outdoor Photography. 120 pgs.

Item # AMODLPP.....29.95

**Better Picture Guide to  
Lighting  
for Portraits**  
by Steve Bavister

Explains the lighting set-ups behind the world's best portrait photography. Each photograph is accompanied by side- and plan-view diagrams showing how the set-up worked. Includes a directory of photographers — an excellent resource for art directors and designers. 160 pgs.

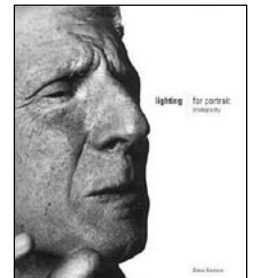

Item # ROLP.....34.95



EQUIPMENT LEASING AVAILABLE

# LIBRARY

## PHOTOGRAPHY BASICS

LIBRARY

673

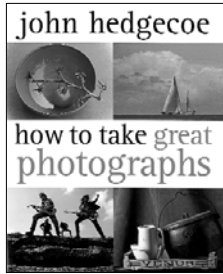

### How to Take Great Photographs

by John Hedgecoe

Bring a master photographer and best-selling author into your home for a "back-to-basics" course on practical photography. This unique series of hands-on exercises, illustrated with more than 200 superb photos, prepares you to work on your skills at your own pace. Details on the latest equipment and specialist techniques. 160 pgs.

Item # STJHHTGP.....24.95

### Getting the Best from Your 35mm SLR Camera

by Michael Burgess

With more than 200 photographs, plus information designed to help you hone basic skills, this introduction to the 35mm SLR camera offers guidance on choosing, buying, and using the equipment. Find out how to analyze an image, take pictures of classic subjects, create special effects with flash, and lots more. 176 pgs.

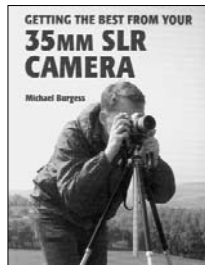

Item # STGBYSC.....17.95



### Take Great Pictures A Simple Guide

by Lou Jacobs, Jr.

What makes a great picture? This book shows those new to photography how to master the basics of exposure, composition, and lighting, making picture-taking more satisfying than ever before. Discussions on multiple formats, films, filters, and artistic techniques make this book perfect for the novice photographer. over 80 full color photos. 112 pgs.

Item # AMTFPSG .....14.95

### Mastering the Basics of Photography

by Susan McCartney

The perfect camera-bag companion for every serious novice photographer who shoots on location in the field. All the basics of camera function are explained in east-to-understand language. Composition and training the photographer's eye to handle light and contrast are fully explored. 192 pgs.

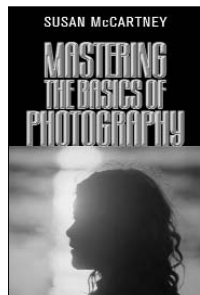

Item # AMMBP.....19.95

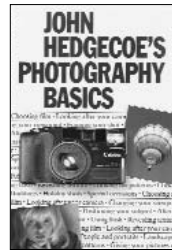

### John Hedgecoe's Photography Basics

by John Hedgecoe

"Hedgecoe uses the most commonly owned beginner's cameras...to demonstrate how the camera works in simple, non-technical language."--Photographic Trade News.

"...The lessons are easy, given the well-laid-out visual examples....Whether those images be action shots or landscapes, candid or portraits, the principles common to all photography guides are on display...."--Booklist. 160 pgs.

Item # STJHPB.....17.95

### The Q&A Guide to Photo Techniques

by Lee Frost

A fully updated, expanded and revised edition of a popular author's most successful book for the photography enthusiast. Essential answers on the basics of photography--both hardware and technique, including the latest digital technology--are presented in the most accessible and interesting way. 144 pgs.

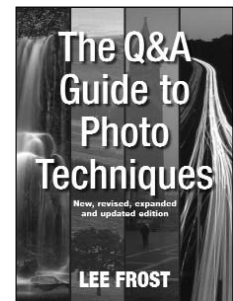

Item # FWQAGPT.....24.95



### Using Your Camera A Basic Guide to 35mm Photography

Revised and Enlarged Edition

by George Schaub

The classic best-seller, completely revised and rewritten! 35mm is still going strong! Designed and written for the amateur, with basic concepts, no-fail techniques, and practical information. The bible for anyone who wants to master the art of 35mm photography. 160 pgs.

Item # AMUYC .....24.95

### Basic 35mm Photo Guide for Beginning Photographers

by Craig Alesse, 5th Edition

Fully illustrated each step of the way. Includes f-stops, shutter speeds, films, lenses, composition, camera care, more. The author has produced television commercials, taught in high schools and colleges, and has written and produced numerous films and slide presentations. Over 170 photos. 108 pgs.

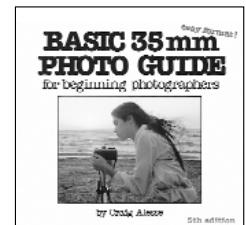

Item # AMB35PG.....12.95

ORDER & INFO. (212) 502-6340 • FAX: (212) 239-7770 (800) 947-7008  
1-800-290-6750 • www.bhphotovideo.com



# LIBRARY

## BABES IN COYLAND

LIBRARY

674



### **Children Techniques and Images in Black & White** by David Wilson

Capture the child's natural character rather than a perfectly posed photograph. Modern and visually appealing. Children shows photographers how to take winning pictures. Invaluable information demonstrates the development of modern techniques including cross-processing and soft focusing. 144 pgs.

Item # ROCCP .....34.95

### **Photographing Children with Special Needs** A complete Guide for Professional Portrait Photographers by Karen Dorame

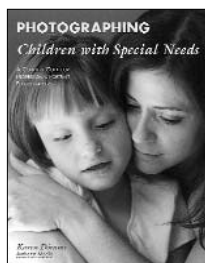

Like all other parents, the moms and dads of special needs children want to celebrate their families' special moments with memorable portraits. This guide shows photographers how to design a shoot and how to meet their subjects' unique needs. 128 pgs.

Item # AMPCSN .....29.95



### **Photographing Children in Black & White** by Helen T. Boursier

Learn the skills needed to create highly marketable black-and-white portraits of children. From siblings on the beach to a child alone with a treasured toy, tried-and-true secrets are given for getting kids to behave, while also making sure that the children are having a good time. Capture those priceless expressions that set every child apart from the crowd. 128 pgs.

Item # AMPCBW .....29.95

### **Photographing Babies and Toddlers** by John Hedgecoe

It's your child's first birthday, so you drag him to a discount photo "studio" where he is propped up in front of a phony backdrop, a strange toy stuffed in his hand, and sternly instructed to smile. You'd cry too if it happened to you! Don't rely on someone else. Do it yourself, with professional tips. 128 pgs.

Item # STPBT .....19.95

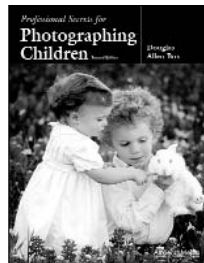
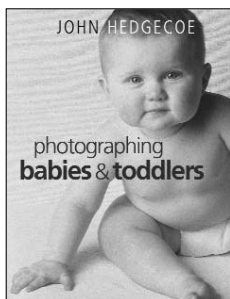

### **Professional Secrets for Photographing Children** Easy and Affordable Techniques for the Photographer by Douglas Allen Box, 2nd Edition

Featuring lighting diagrams for every image, this book covers everything you need to create memorable images of children of all ages. Included are: working with kids, posing, equipment selection, and special event photography. 128 pgs.

Item # AMPSPCQ .....29.95

### **Studio Portrait Photography of Children and Babies** by Marilyn Sholin 2nd Edition

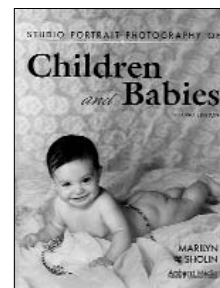

Learn to work with the youngest portrait clients to create images that will be treasured for years to come. Includes tips for working with kids at every developmental stage, from infant to preschooler. Features: lighting, posing and much more. 128 pgs.

Item # AMSPPCB .....29.95



### **Creative Techniques for Photographing Children** by Vik Orenstein

Regardless of experience and skill, anyone can capture the magic of childhood on film with Vik Orenstein's technical and creative advice. He provides nine professional portraiture projects that range from simple to challenging. Each one comes with the detailed advice and step-by-step instructions needed to photograph children like a pro. 160 pgs.

Item # FWCTPC .....29.95

### **How to Photograph Your Baby's First Year** by Laurie White Hayball

This simple guide shows those without a background in photography how to take the best possible pictures during their child's first year. With technical and artistic tips, this book cleverly points to endearing photo opportunities, as well as those that can be created with a few simple props. 112 pgs.

Item # AMHPYBFY .....14.95



For Any Inquiries Regarding Your Order, Call Our Customer Service:  
(800) 221-5743 • (212) 239-7765 • FAX: (800) 947-2215 • (212) 239-7549

# LIBRARY

## ALL IN THE FAMILY

LIBRARY

675

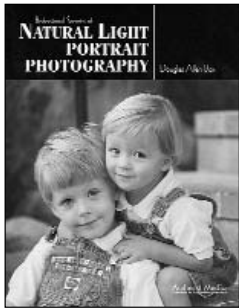

### **Professional Secrets of Natural Light Portrait Photography**

by Douglas Allen Box

Create stunning portraits of children, couples and families with the simple beauty of natural lighting. Window, porch, shade, and all lighting types and situations are discussed in this step-by-step manual. Over 80 full color photos. 128 pgs.

Item # AMPSNLPP.....29.95

### **Family Portrait Photography Professional Techniques and Images**

by Helen Boursier

Take great family portraits and market your work. Includes: posing, lighting, working with clients, shooting on location, attracting business, running promotions and presenting your portraits effectively. 128 pgs.

Item # AMFPP.....29.95

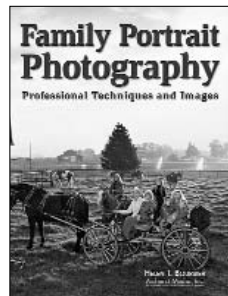

### **Family Portraits**

by David Daye

Instructions for the photographer in shooting family portraits tailor-made to specific age groups. How to photograph toddlers who won't keep still, to tips about sensitive lighting designed to complement older subjects. Create distinctive portraits of babies, young children, teenagers, couples, seniors, and family groups. 144 pgs.

Item # FWFPPP.....34.95

### **Photographing Your Children**

by John Hedgecoe

Preserve every landmark event and stage of your children's lives in professional-quality photographs. Best-selling author and renowned photographer John Hedgecoe offers parents, grandparents, and family friends plenty of helpful advice on getting the most out of your young models. 400 full-color photographs; creative ideas and tips. All in color. 144 pgs.

Item # STPC.....19.95

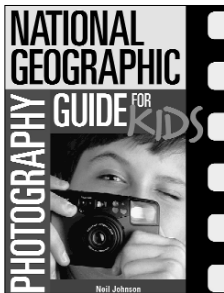

### **National Geographic Photography Guide for Kids**

by Neil Johnson

A practical, inspiring photo guide especially for kids ages 10 and up. Text, photos, and diagrams teach basic photographic concepts, using a variety of simple point-and-shoot cameras. A section on digital photography. Full color photos. 80 pgs.

Item # AMNGPGK.....12.95

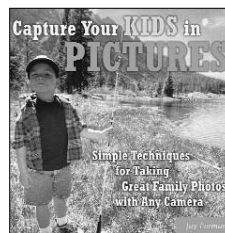

### **Capture Your Kids in Pictures**

Simple Techniques for Taking Great Family Photos with Any Camera

by Jay Forman

Using stunning yet unintimidating photographs and simple techniques, this photography guide teaches parents or grandparents how to take better photographs of their children. The images are the main teaching tools. 144 pgs.

Item # AMCYKP.....19.95

### **Group Portrait Photography Handbook**

by Bill Hurter

Of all the portrait specialties, photographing groups is particularly demanding. How do you pose a group? How do you keep everyone in sharp focus, let alone create an interesting composition? Bill Hurter, editor of Rangefinder magazine, provides a detailed study of what makes group portraiture work. Illustrated with images by top portrait photographers. 128 pgs.

Item # AMGPPHB.....29.95

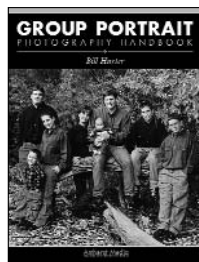

### **The Best of Children's Portrait Photography Techniques and Images from the Pros**

by Bill Hurter

Get behind the images and see how award-winning photographers create memorable portraits that capture the magic of childhood. The author and editor of Rangefinder magazine draws on the work and experience of over twenty top professional photographers in the portrait industry. 128 pgs.

Item # AMBCPP.....29.95

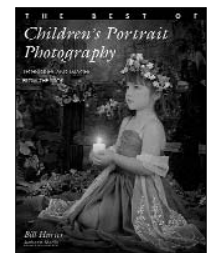

ORDER & INFO. (212) 502-6340 • FAX: (212) 239-7770 (800) 947-7008  
1-800-290-6750 • www.bhphotovideo.com



# LIBRARY

## PHOTOSHOP

LIBRARY

676

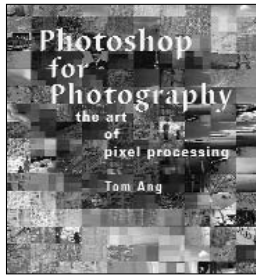

### **Photoshop for Photography** The Art of Pixel Processing by Tom Ang

In this essential guide, expert photographer Tom Ang demonstrates how anyone can harness the creative potential of photo-enhancing software to create simply superb images using nothing more than basic computer

equipment and an ink-jet printer. 128 pgs.

Item # AMPPH.....24.95

### **Photographer's Guide to Photoshop** by Barrie Thomas

A practical step-by-step guide by Britain's leading Photoshop lecturer and Adobe Certified Expert. Specifically tailored to the demands of the photographer. Simple and easy-to-follow. Guides readers through everything they need to know from the simple tasks of organizing image files and learning the basic controls, to sophisticated colour correction and image manipulation techniques. 144 pgs.

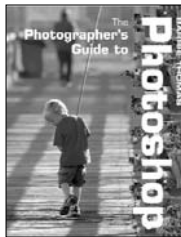

Item # FWPGPS.....29.95

### **Creative Photoshop Lighting Techniques** by Barry Huggins

A good understanding of light and lighting can render realistic drama to images in Adobe Photoshop. From bringing sunshine to photos of a cloudy day to creating underwater effects, it's all here, well illustrated and explained beautifully. Find out

about light sources, color temperature, and classic studio lighting setups. A must-have for any Photoshop user. 192 pgs.

Item # STCLPT.....29.95

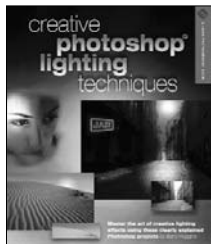

### **Traditional Photographic Effects with Adobe Photoshop**

by Michelle Perkins & Paul Grant, 2nd Ed.  
Learn to Simulate Infrared  
Photography, Create Vignettes,  
Handcolor Photos, and more..

Use Photoshop to achieve traditional photo effects; to add the look of specialized filters and techniques, how to achieve darkroom effects without a darkroom, create handcolored images, and much more. 128 pgs.

Item # AMTPEAP.....29.95

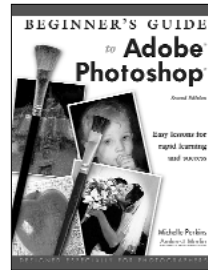
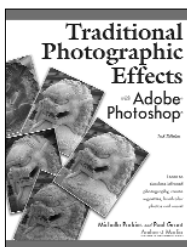

### **Beginner's Guide to Adobe Photoshop** Easy Lessons for Rapid Learning and Success by Michelle Perkins, 2nd Edition

Unlike most Photoshop books which overload you with information you'll never need, this guide to Adobe Photoshop focuses on the skills that are critical to using the program effectively—tools that you will use

everyday, with every image. 128 pgs.

Item # AMBGAP.....29.95

### **Photo Salvage with Adobe Photoshop** Techniques for Saving Damaged Prints, Slides and Negatives by Jack & Sue Drafahl

Problem slides, negatives, prints? This book is your step-by-step guide to restoring them to their original condition—and even making them look better than they ever did before.

Learning how best to convert your images to digital files, and what hardware and software you'll need to manipulate them. 128 pgs.

Item # AMPSAPQ.....29.95

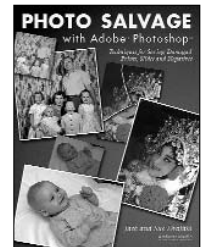

### **Plug-Ins for Adobe Photoshop** A Guide for Photographers by Jack & Sue Drafahl

Improve images quickly and easily with these Adobe Photoshop® accessories. With plug-ins, you can amplify your imaging experience and abilities beyond your wildest dreams.

Introduces can't-miss special effects like lighting, puffy white clouds, and puzzle pieces, plus red-eye removal and other handy tools. 128 pgs.

Item # AMPIAP.....29.95

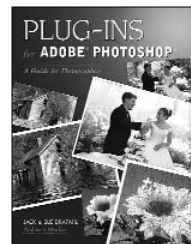

### **The Photoshop User's Encyclopedia** Every Photoshop Term You're Ever Likely to Need, See or Use by Peter Cope

It is the sheer size of Photoshop--that all-encompassing system universally used by designers, illustrators, and photographers--that makes it the leading application. More than 3000 examples of lingo and over 650 color photos will guide you through the language maze. 256 pgs.

Item # STPUE.....24.95

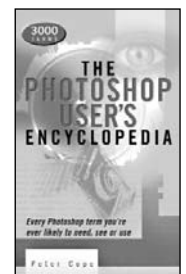

EQUIPMENT LEASING AVAILABLE

# LIBRARY

## CREATIVE COMPOSITION

LIBRARY

677

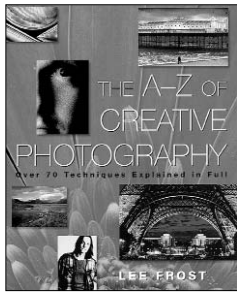

### **The A-Z of Creative Photography**

by Lee Frost

More than seventy techniques are covered in detail – including advanced exposure, bounced flash and candlelight, infrared, multiple images, soft-focus effects, unusual vantage points, zooming, and more. Tips for each technique help readers achieve superb results, even on the first attempt. 160 pgs.

Item # AMAZCP .....24.95

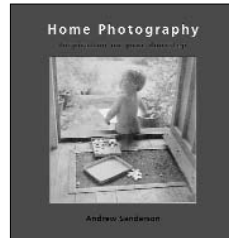

### **Home Photography**

#### **Inspiration on Your Doorstep**

by Andrew Sanderson

An accomplished photographer reveals how some of the best subjects for creative and compelling photographs are usually right in one's home. Even the most mundane objects can be transformed into striking images. Ten expertly written chapters demonstrate the myriad ways family, friends, a garden, animals, or a backyard view can be imaginative works of art. 128 pgs.

Item # AMHPH .....24.95

### **The Creative Photography Handbook**

by Lee Frost

This invaluable sourcebook of techniques and ideas from a best-selling author is guaranteed to put the creativity back into your photography. More than 70 creative techniques and subject ideas to help you produce exciting, innovative images. Spice up your picture-taking with this invaluable sourcebook of ideas and effects. 160 pgs.

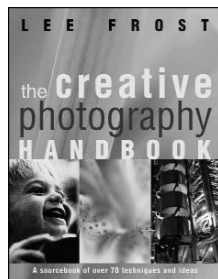

Item # FWCPHB .....24.95

### **Learning to See Creatively**

#### **Design, Color & Composition in Photography**

by Bryan Peterson, Revised Edition

Almost everyone can “see” in the conventional sense, but developing photographic vision takes practice. This guide helps photographers visualize their work, and the world, in a whole new light. Now totally rewritten, revised, and expanded, this best-selling guide takes a radical approach to creativity. 160 pgs.

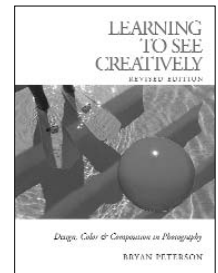

Item # AMLSC .....24.95



### **Zoom Lens Photography**

by Raymond Bial

The owner's manual for zoom lenses! Includes how to take vacation, landscape, still life, sports and other photos. Features how to choose the right zoom lens, mastering photography with a zoom, taking care of your lens, zoom tricks and special effects. Raymond Bial is a professional writer, photographer, and college librarian. 112 pgs.

Item # AMZLP .....14.95

### **Creating World-Class Photography**

#### **How Any Photographer Can Create Technically Flawless Photographs**

by Ernst Wildi

Learn to identify and correct technical flaws in your images and create high quality, world-class photographs. Formerly released as Achieving the Ultimate Image, this book has been revised in full color and completely updated! 50 color photos, 128 pgs.

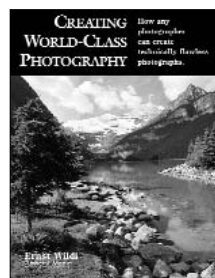

Item # AMCWCP .....29.95

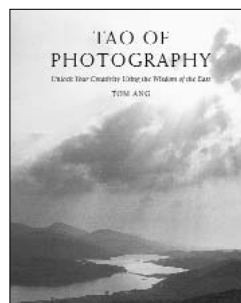

### **Tao of Photography**

#### **Unlock Your Creativity Using the Wisdom of the East**

by Tom Ang

Combining ancient principles of harmony with modern camera techniques, this unusual book offers new ways to innovative, meaningful, and memorable pictures. Apply Tao concepts of Yin and Yang and “the Way” to photography. 144 pgs.

Item # AMTPK .....29.95

### **Elements of Color Photography**

#### **The Making of Eighty Images**

by George E. Todd

A veteran photographer distills the knowledge and experience he gained over 30 years as a writer, teacher, and practicing photographer. Clear step-by-step illustrations show how color photography can become as effective a composition tool and as fine an art form as monochrome. Features dazzling, full-color examples of photographic techniques in action. 128 pgs.

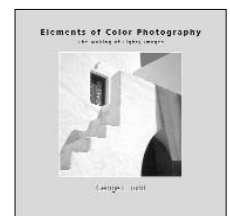

Item # AMECP .....29.95

ORDER & INFO. (212) 502-6340 • FAX: (212) 239-7770 (800) 947-7008  
1-800-290-6750 • www.bhphotovideo.com



# LIBRARY

## ART & CRAFT

LIBRARY

678

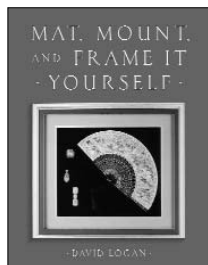

### **Mat, Mount, and Frame It Yourself**

by David Logan

A great deal of planning is essential for success: Logan shows how to compose the entire presentation so that it will be aesthetically pleasing. Some of the tools and materials required are fairly common (e.g., saws and molding), while others are more esoteric (e.g., museum-grade matboard).

Attractive photos are a helpful resource for beginners to copy. For framers of all skill levels. 160 pgs.

Item # AMMMFIY .....24.95

### **The Photographer's Guide to Using Filters**

by Joseph Meehan, Revised Edition

Combining technique and creativity, this book remains the definitive source for data about the full range of filters and their application with both color and black-and-white film. Now that so many different filters are available, serious photographers may take a dozen on a photo shoot for producing the different effects that are shown in these pages. 144 pgs.



Item # AMPGUFP.....24.95

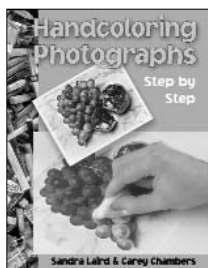

### **Handcoloring Photographs Step by Step**

by Sandra Laird, Carey Chambers

Handcoloring is easy to learn, creatively satisfying, and fun. Takes you step-by-step through the hand-coloring process, using a variety of media, like oils and watercolors. Easy-to-understand instructions and illustrations. Builds your knowledge and encourages you to try new techniques. 112 pgs.

Item # AMHCPSBS.....29.95

### **The New Photo Crafts Photo Transfer Techniques and Projects for Fabric, Paper, Wood, Polymer Clay and more**

by Suzanne Tourtillot

If you have favorite family photos stored away, they can be transformed into great projects from wearable art to lampshades and home decor accessories. This book is filled with ideas which include using a photocopier or color computer printer to create unique designs. 128 pgs.

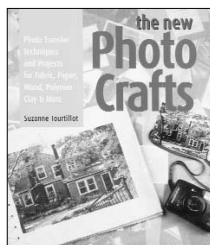

Item # STNPC.....18.95

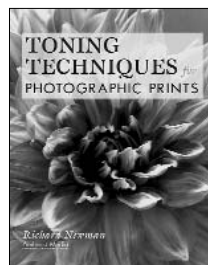

### **Toning Techniques for Photographic Prints**

by Richard Newman

Whether you want to extend the longevity of your black & white prints, improve contrast, "antique" your images, or treat them to electrifying color, this book is for you. Richard Newman brings toning out of the dark—and out of the darkroom. With minimal equipment and a well-ventilated

space, anyone can learn to tone prints. 128 pgs.

Item # AMTTPP.....29.95

### **Family Photocrafts Preserving Your Treasured Past in Special Ways**

by Marie Browning

With a color copier or laser printer, these images can grace any number of decorative items. Open up those scrapbooks and journals to find a wealth of material for découpage, transfers, and designs. Projects include a Vacation Memory Box, Baby Door Sign, Beaded Photo Purse and Beveled Glass Ornament. 128 pgs.



Item # STFP.....14.95

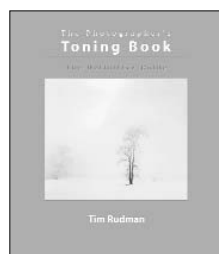

### **The Photographer's Toning Book**

by Tim Rudman

Appropriate for beginners as well as experienced professionals, the guide covers such processes as selective toning; archival and negative toning; simple and advanced uses of bleaches and developers; using unconventional, such as tea and coffee; making homemade toners; and much more. 208 pgs.

Item # AMPTB.....29.95

### **Photographers' Guide to Web Publishing**

by Charles Saunders

The Internet offers photographers an unprecedented opportunity to exhibit (and sell) their work worldwide. This insightful and succinct manual gives them the expertise needed to do it. No sophisticated or expensive equipment is required. Easy-to-follow approach to building and maintaining a professional-looking Web site. 192 pgs.

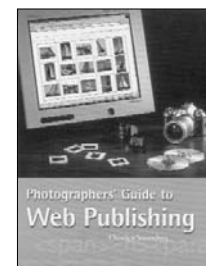

Item # STPGWP.....19.95



EQUIPMENT LEASING AVAILABLE



# LIBRARY

## ART & CRAFT

LIBRARY

679

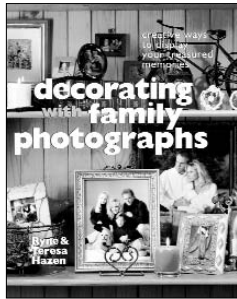

### **Decorating with Family Photographs**

**Creative Ways to Display Your Treasured Memories**

by Ryne & Teresa Hazen

“Truly a picture book. It shows, rather than tells, how to display photographs in every nook of your house. Provides ample illustration that a picture is really worth 1000 words.”—Somerset Studio  
128 pgs. All in color.

Item # STDFP.....14.95

### **Designing a Photograph** **Visual Techniques for Making Your Photographs Work**

by Bill Smith, Revised Edition

This revised and updated edition of the classic manual provides all the information photographers need to bring their art to the next level. Filled with practical, real-life examples and excellent step-by-step exercises. Demonstrates techniques of composition, color, lighting, perspective, and more. 144 pgs.

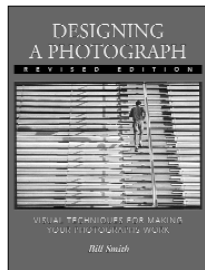

Item # AMDPQ.....24.95



### **The Art of Handpainting Photographs**

by Cheryl Machat Dorskind

The process of handpainting photographs combines the art of black-and-white photography with a personal expression of color. Create evocative portraits, picturesque landscapes, or vivid street scenes

that reflect your individual vision and perception of the world. Entire handpainting process from start to finish. 144 pgs.

Item # AMAHPP.....24.95

### **Toning and Handcoloring Photographs**

by Tony Worobiec

Perhaps as a reaction against the growing tide of digital photography, many traditional photographic techniques are enjoying a creative revival. The most popular are the related skills of toning and handcoloring. Now you can master this unique, age-old technique. Readers are taken step-by-step through each process. 170 gorgeous photographs. 128 pgs.

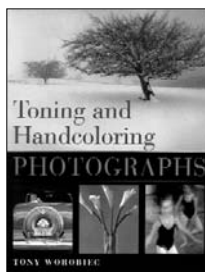

Item # AMTHP.....24.95

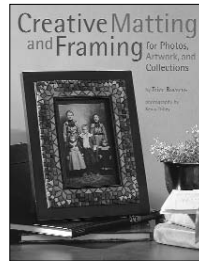

### **Creative Matting and Framing**

**For Photos, Artwork, and Collections**

by Trice Boerens,

photographs by Kevin Dilley

Features innovative projects for creating beautiful frames with stamping, polymer clay, decoupage, fabric, mosaics, and even leaves, shells, and flowers. Turn an ordinary mat or frame into an extraordinary treasure! 112 pgs.

Item # AMCMF.....19.95

### **Fine Art Photography**

Terry Hope

The fine art market is flourishing on an international scale. Shows and new galleries dedicated to photography are opening to cater for that demand. This beautifully illustrated book looks at all aspects of this growing market and advises photographers of all levels on how to get involved 160 pgs.

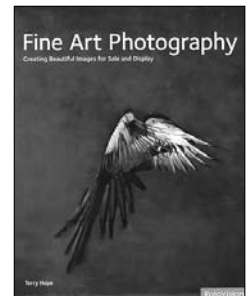

Item # ROFAP.....34.95

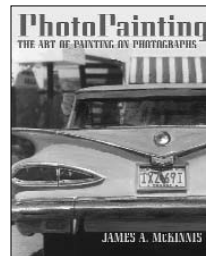

### **PhotoPainting** **The Art of Painting on Photographs**

by James A. McKinnis

Perfect for all levels, from beginner to veteran artist. Demonstrates how to create an array of photopainting techniques. This guide shows artists, photographers and crafters how to take handcoloring photographs to the next level, transforming the original into something closer to a painting than a photo. 144 pgs.

Item # AMPP.....24.95

### **Photographic Composition** **Guidelines for Total Image Control Through Effective Design**

by Tom Grill and Mark Scanlon

Effective image design, a key ingredient in successful photographs, is a skill that any serious photographer must learn and master. This guide demonstrates a modern, clear and easily understandable approach to composing great photographs. Combines straightforward text with instructive yet compelling images. 144 pgs.

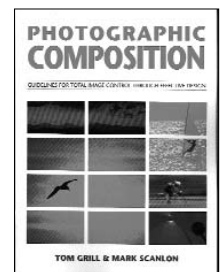

Item # AMPC.....19.95

# LIBRARY

## ADVANCED PHOTOGRAPHY

LIBRARY

680

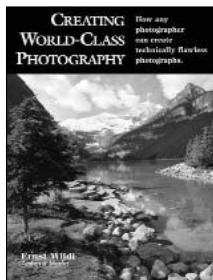

### *Creating World Class Photos*

**How any photographer can create technically flawless photographs**

by Ernst Wildi

Learn to identify and correct technical flaws in your images and create high quality, world-class photographs. Formerly released as *Achieving the Ultimate Image*, this book has been revised in full color and completely updated. 80 pgs.

Item # AMCWCP.....29.95

### *Advanced Infrared Photography Handbook*

by Laurie White Hatball

Building on the techniques taught in Laurie White's popular *Infrared Photography Handbook*, this book features information on light metering, how to develop "infrared sensitive" eyes, improving shadow detail, and much more. Laurie's images sell as fine art and have been the subject of exhibit. 100 full color photos. 128 pgs.

Item # AMAIPH.....29.95

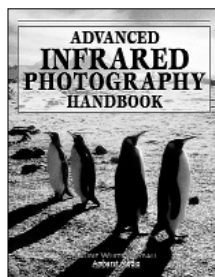

### *Extreme Photography*

**The Hottest, Coldest, Largest, Smallest, Fastest, Slowest, Brightest, Darkest, Weirdest**

by Terry Hope

Photography is about much more than putting the camera to the eye and pressing the shutter. Sometimes it's too small, too

large, far away, too hot, too cold or hidden from the eye. This book takes the medium to the limits of possibility and beyond human capability—a definitive guide to alternative image making. 160 pgs.

Item # ROEP.....24.95



### *Advanced Photography*

by Michael Langford, 6th Ed.

A practical book for students and serious enthusiasts who wish to achieve more professional looking results. From choosing lenses and camera equipment, to film types and technical data, lighting and tone control, processing management and color printing; technical solutions and practical advice on all aspects of professional photography. 336 pgs.

Item # FOAP.....49.95

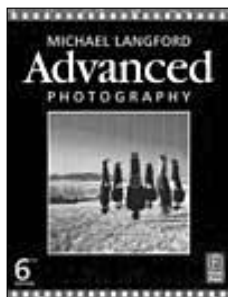

### *Architecture Developing Style in Creative Photography*

by Terry Hope

Unlike most Photoshop books which overload you with information you'll never need, this guide to Adobe Photoshop focuses on the skills that are critical to using the program effectively—tools that you will use everyday, with every image. 128 pgs.



Item # ROBWPA.....29.95

### *Xtreme Sports photography Taking Pictures on the Edge*

by David Corfield

A visually explosive adrenaline rush of a book for adventurous photographers and xtreme sports fans. Showcases the stunning work of over 30 of the world's greatest xtreme sports photographers, including Bob Martin, Richard Pelham, and Neale Haynes, many of whom are winners of prestigious international awards. Insight into the art of capturing vital images. 176 pgs.

Item # ROESP.....34.95



### *The Art of Panoramic Photography*

by Nick Meers, intro by Leo L. Larson



An inspirational guide to creating panoramic pictures using everything from simple 35mm and

APS cameras, through more specialized medium- and large-format cameras, right up to the 360-degree digital panoramas. A must-have book for anyone with an interest in panoramic photography. 144 pgs.

Item # ROS.....29.95

### *Applied Photographic Optics*

by Sidney F. Ray, 3rd Edition

A complete, comprehensive reference source for anyone wanting information on photographic lenses, from the student to the practitioner or specialist. This third edition has been expanded to include the rapid progress in the last decade in optical technology and advances in relevant electronic and digital forms of imaging.

Item # FOAPO.....157.95

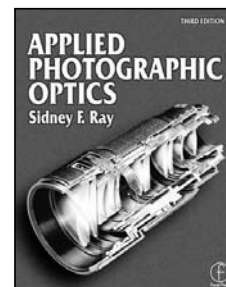

For Any Inquiries Regarding Your Order, Call Our Customer Service:  
(800) 221-5743 • (212) 239-7765 • FAX: (800) 947-2215 • (212) 239-7549

## ADVANCED PHOTOGRAPHY

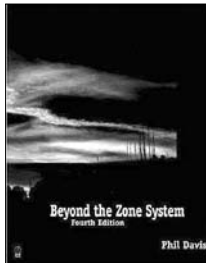

### **Beyond the Zone System** by Phil Davis, 4th Edition

This edition of Beyond the Zone System makes the science of photographic sensitometry both accessible and useful to interested photographers. It will appeal to any serious photographer interested in knowing how the materials and processes of black-and-white photography work. Provides the basis for understanding what needs to be

done and why. Promote a true partnership of science and art. 220 pgs.

Item # FOBZS .....46.95

### **Professional Press, Editorial & PR Photography** by Jon Tarrant

Packed with hints, tips and first-hand advice on the day-to-day running of a business, the equipment you need and how to organize your finances, and how to get the best results — all the things that professionals might wish they had known when they first started out. 192 pgs.

Item # FOPPEPR .....39.95

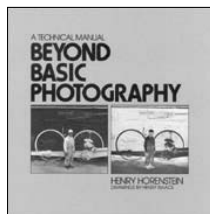
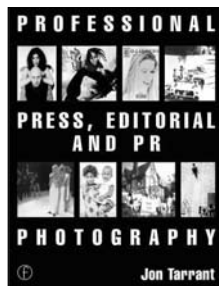

### **Beyond Basic Photography** A Technical Manual by Henry Horenstein

This book answers the more technical questions of photographers who are already familiar with the basics. The author discusses in detail: the negative,

photo chemistry, processing, techniques for control in both film and print processes, light, and view camera techniques. Illustrated with almost two hundred drawings and photographs. 242 pgs.

Item # LIBBP .....26.50

### **Photos With Impact** by Tom MacKie

Learn how to view your subject, compose your picture, and take the best image possible with this stunning new guide from a renowned photographer. Taking - and making - a photograph that will have more impact than others requires much insight and the harnessing of abilities and techniques. Tom MacKie recognizes that a key technique in his work is the ability to see subjects that others might miss. 144 pgs.

Item # FWPWI .....24.95



### **Photographic Possibilities** The Expressive Use of Ideas, Materials, Processes

by John Valentino & Robert Hirsch

A reliable source of techniques and ideas for the use of alternative and contemporary photographic processes. Integrates technical methods with aesthetic outcome. Discover modern and classic methods of creating and manipulating images in clear, step-by-step instructions. 272 pgs.

Item # FOPPO .....39.95

### **The Practical Zone System** A Guide to Photographic Control by Chris Johnson, 3rd Edition

The subject of the zone system is now very much in the mainstream among amateur as well as professional photographers. This newly revised edition of a photography classic teaches photographers how to recognize the zones both on the print and in the field or studio, to pre-visualize their photograph and expose accordingly. 176 pgs.

Item # FOPZS .....46.95

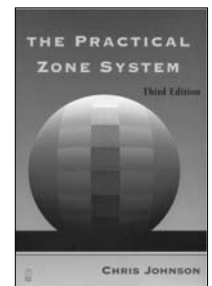

### **Fine Art Photography** by Terry Hope

The fine art market is flourishing on an international scale. This beautifully illustrated book looks at all aspects of this growing market and advises photographers of all levels on how to get involved. Sections on producing, exhibiting and selling your work as well as a study of photographers who've "cracked" the market make this book a truly comprehensive guide to breaking successfully into the business. 160 pgs.

Item # ROFAP .....34.95

### **Zone System for 35mm Photographers** by Carson Graves, 2nd Edition

Thousands of photographers have used the simple techniques described in this book to produce consistently excellent negatives and luminous prints. This new edition shows photographers how to apply the principles and procedures of the Zone System to both black and white and color photography. 144 pgs.

Item # FOZS35P .....39.95

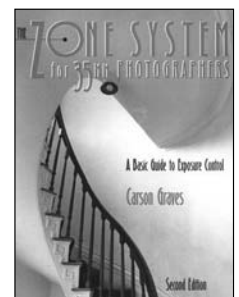

# LIBRARY

## SHOOT

LIBRARY

682

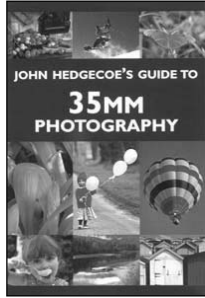

### **John Hedgecoe's Guide to 35mm Photography**

The world's best-selling photography author shows how to achieve professional results in a pocket-sized guide. Questions answered include: how a camera works, films, exposure and lighting, including sunlight and flashes. Develop your skills with tips on equipment and techniques needed for photographing unusual viewpoints, wildlife, filter effects, still lifes, portraits, sunsets, and more.

Item # STJHG35P.....12.95

### **Photography The New Complete Guide to Taking Photographs** by John Freeman

Become a better photographer with hundreds of tips for taking more creative and expressive photographs with APS, SLR and digital cameras. Sixteen easily understood sections, including Understanding Cameras and Film, Photographing People, Nature, The Urban Landscape, and more. Improve the quality of your photos. 288 pgs.

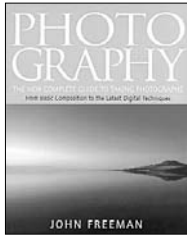

Item # STPH.....29.95

### **Photographer's Filter Handbook**

**A Complete Guide to Selection and Use**  
by Stan Sholik & Ron Eggers

Begins with a primer on the electromagnetic spectrum and light absorption. All about filters; the materials from which they are made; how specific filters work; how to compensate for a change in available light. 128 pgs.

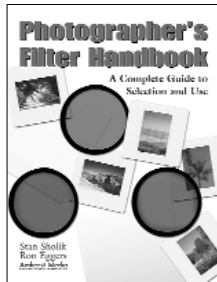

Item # AMPFHB.....29.95

### **Mastering Flash Photography**

**A Course in Basic to Advanced Lighting Techniques**  
by Susan McCartney

Vitaly important to all photographers, lighting is thoroughly explored in this first fully color-illustrated guide to flash techniques, from point-and-shoot to studio work. Learn, or improve your flash techniques. 144 pgs.

Item # AMMFP.....24.95

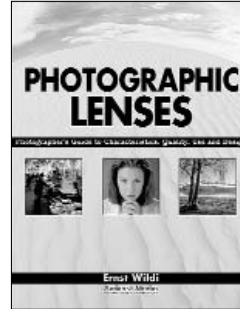
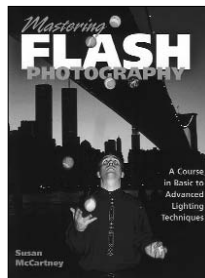

### **Photographic Lenses** by Ernst Wildi **Photographer's Guide to Characteristics, Quality, Use and Design**

World-renowned photographer approaches the topic of lenses and optics from a photographer's point of view. He covers terminology, how different types of lenses function, and the pros and cons of the different makes and models.

Item # AMPL.....29.95

### **Secrets of Color in Photography** by Jim Zuckerman

The captivating images of acclaimed photographer Jim Zuckerman embody the perfect union of light, composition and color. Photographers of all skill levels will learn how to capture the same stunning, beautiful effects in their own work with filters, artificial lighting, digital imagery and more. 144 pgs.

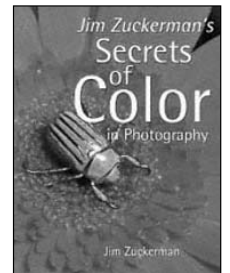

Item # FWJZSCP.....27.95

### **Beginner's Guide to Pinhole Photography** by Jim Shull

Kids and adults can take pictures with their own homemade cameras. Includes building a camera, selecting paper or film, making the exposure, developing and printing – all in easy, step-by-step language. Jim Shull teaches workshops for young people at a center for art and ecological studies. 80 pgs.

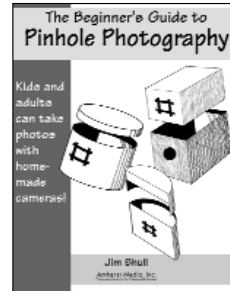

Item # AMBGPHP.....17.95

### **Photography A Crash Course** by Dave Yorath

An amusing, often surprising, always informative illustrated guided tour through the history of photography and the story of the people and the technology behind the images. Filled with fun facts. Showcases important photographs that help document history and define our culture, as well as the photographers who took them. 144 pgs.

Item # AMPCCQ.....14.95

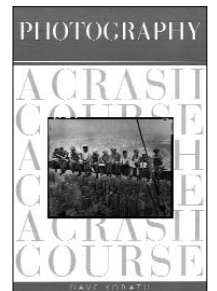

[www.bhphotovideo.com](http://www.bhphotovideo.com)

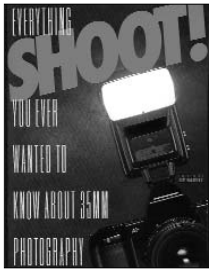

**Shoot!**  
**Everything You Ever Wanted to Know About 35mm Photography**

*Liz Harvey*

Whether you're just starting out in 35mm photography or you want to improve your technique, Shoot! is the book you've been waiting for. Its 256 pages are filled to the brim with the finest instruction—detailed information and helpful advice — from

fourteen of the world's leading photographers. 256 pgs.

Item # AMSQ .....29.95

**National Geographic Photography Field Guide**  
**Secrets to Making Great Pictures**  
*by Peter K. Burian and Robert Caputo*

From the institution that set the standard for exceptional photography comes the definitive how-to volume – fully revised and updated with the latest information. Inspires as it informs. Stories of how and why photographers made their photos gives insight and helps you take your own best pictures.

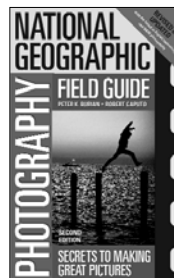

Item # AMNGPFG .....24.95

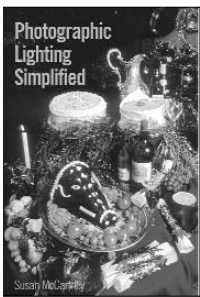

**Photographic Lighting Simplified**  
*by Susan McCartney*

The ultimate guide to lighting! In nontechnical terms, this book shows how to take existing light sources—bright sunlight or indoor lighting— and recreate their effects in the studio. Also addresses the lighting challenges of digital cameras. 192 pgs.

Item # AMPLS .....19.95

**The Essential Photography Manual**  
*by Tim Daly*

An essential user-friendly reference guide to photography. Explains photographic equipment and techniques, along with practical tips and advice from the professionals. Beautiful full-page photographs. A comprehensive encyclopedia features diagrams and thumbnail photographs illustrating all the key photographic terms and concepts. 208 pgs.

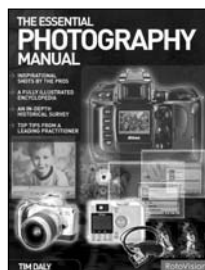

Item # ROEPM .....34.95



**Lighting for Interior Photography**  
*by John Freeman*

Illustration and text explains how interior lighting effects are achieved through the examination of work by leading contemporary photographers. The images have been chosen for their stylishness, diversity and technical excellence. A complete guide to photographing interiors. 160 pgs.

Item # ROLIP .....34.95

**Beginner's Guide to Photographic Lighting**  
**Techniques for Success in the Studio or on location**  
*by Don Marr*

Master the lighting tools used by professional photographers to achieve flawless images. Created for advanced amateurs and photography students, this book includes dozens of lighting diagrams and practical lessons with step-by-step text and images. 128 pgs.

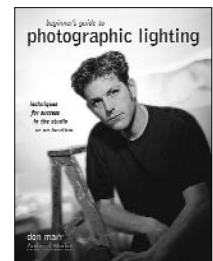

Item # AMBGPL .....29.95

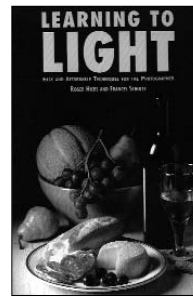

**Learning to Light**  
**Easy and Affordable Techniques for the Photographer**  
*by Roger Hicks and Frances Schultz*

Amateurs who assume that artificial light is too technical and expensive for their use will quickly dispel that thought with the help of this guide. This practical book—split into two main sections, Techniques and Equipment, and Projects—should be on every photographer's bookshelf. 160 pgs.

Item # AMLL .....24.95

**Infrared Photography Handbook**  
*by Laurie White Hatball*

Discover the unique world of infrared photography. Features of this volume include: taking your first roll of infrared photos, proper equipment, darkroom techniques, composition, and more. Laurie has filmed MTV music videos, educational films, commercials, and dramatic shorts. 112 pgs.

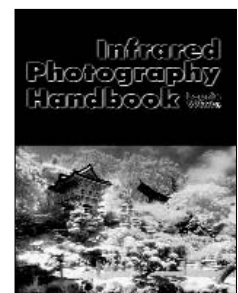

Item # AMIPHB .....29.95

# LIBRARY

## CLASS ACT

LIBRARY

684

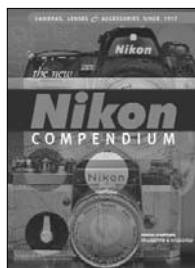

### **Nikon Compendium**

by Simon Stafford, Rudi Hillebrand  
& Hans-Joachim Hauschild

The thoroughly revised, fully illustrated edition of The Nikon Compendium is updated to include all the new Nikon cameras, lenses, and accessories. Describes virtually every Nikon camera ever produced, right up to the wide variety of popular digital models.

Professional and amateur photographers, enthusiasts, collectors and retailers will want this book. 416 pgs.

Item # STNC .....29.95

### **Nikon Camera Repair Handbook**

by Thomas Tomosy

Learn to diagnose, repair and restore this popular brand of cameras. Includes information on camera bodies, lenses and accessories, with basic through advanced techniques explained in clear language. Thomas Tomosy is a European trained master camera technician. 160 pgs.

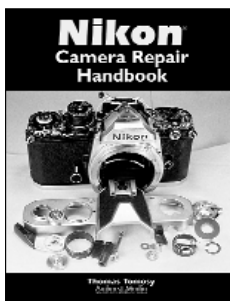

Item # AMNCRB.....39.95

### **Restoring Classic & Collectible Cameras**

by Tony Worobiec

Step-by-step instructions show how to restore a vintage camera. Learn to work on antique leather, brass and wooden components to achieve a complete camera restoration. An excellent illustrated guide. Perfect for camera collectors. 128 pgs.

Item # AMRCCC.....34.95

### **Camera Maintenance & Repair**

Advanced Techniques  
A Comprehensive,  
Fully Illustrated Guide  
by Thomas Tomosy, Book 2

Building on the basics covered in the first book, this book teaches advanced troubleshooting and repair techniques. It's easy to read and filled with photos. 175 black & white photos and diagrams. 176 pgs.

Item # AMCMR2 .....29.95



### **Nikon N75/F75**

by Klaus-Peter Bredschneider

The N75 (also called the F75 in Canada and elsewhere) is Nikon's new, powerful, compact single-lens reflex (SLR) camera; and if you want to learn how to make the most of its capabilities, this well-illustrated Magic Lantern Guide provides all the necessary facts and fundamentals. From the button functions to the exposure basics, every facet of the camera comes into clear focus. 176 pgs.

Item # STMLGNN75.....19.95

### **Canon EOS Rebel Ti EOS 300V**

by Arthur Landt

Lantern guides show the way to sophisticated picture-taking. This latest entry in the series focuses on the brand-new Canon EOS Rebel Ti (EOS 300V outside of North America). The Rebel series already popular, this new model is even lighter, faster and easier to operate--perfect for amateurs. 176 pgs.

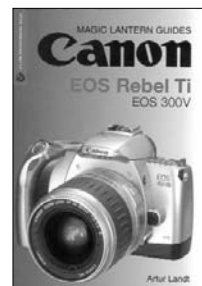

Item # STMLGCERTI.....19.95



### **Leica Camera Repair Handbook**

by Thomas Tomosy

A detailed technical manual for repairing and restoring these classic cameras, lenses and accessories (including light meters, winders/motors, viewfinders and flash units). Step-by-step instructions for each model. 140 pgs.

Item # AMLCRHB.....39.95

### **Restoring the Great Collectible Cameras 1945-1970**

by Thomas Tomosy

Covers the most sought after 1945-1970 camera models. Includes disassembly and cleaning, as well as fabricating new parts, tool alternatives and repair methods. Over 240 illustrations. 128 pgs.

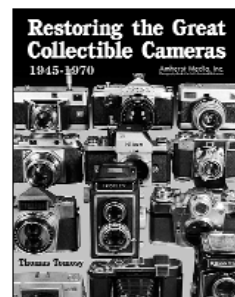

Item # AMRGCC.....34.95



EQUIPMENT LEASING AVAILABLE

# LIBRARY

## CLASS ACT

LIBRARY

685



### Camera Maintenance & Repair Fundamental Techniques A Comprehensive, Fully Illustrated Guide

by Thomas Tomosy, Book 1

Learn to maintain and repair your own camera equipment. Clear step-by-step instruction on the repair of all popular camera formats. Features specialized repair techniques for hundreds of cameras. 176 pgs.

Item # AMCMR .....29.95

### Collectors Guide to Kodak Cameras

by James M. McKeown

A comprehensive and current guide that describes and illustrates Kodak cameras from antiques up to today's models. A useful and wonderful guide to most famous Kodak cameras marketed into US. Includes many rare Kodak cameras as well as the disc and instant cameras. 176 pgs.

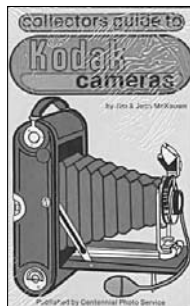

Item # AMCGKC.....16.95

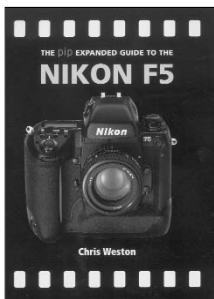

### Nikon F5

by Chris Weston

A hands-on guide to using Nikon's flagship 35 mm camera, the F5. With hundreds of color photos and charts, this illuminating guide demystifies the model's almost endless number of features. It explains simply how to make the most of the cross-ranged, 5-area autofocus sensor; color matrix metering; high speed film advance with up to 8 frames per second; and more. 192 pgs.

Item # STPIPGNF5.....19.95

### Canon Classic Cameras

by James M. McKeown

A comprehensive guide to over 25,000 cameras from the earliest years to the present. Updated with thousands of new additions, and with countless new photos being added. Over 25% of the cameras listed in this guide are not included in any other reference. The prices are based on up-to-the-minute sales data from a giant computer database. The source authority on collectible cameras worldwide, this book is a must for camera and antique buffs. 900 pgs.



Item # HOCCC.....19.95

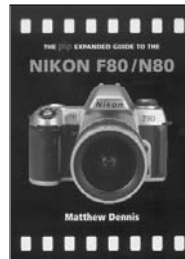

### The PIP Expanded Guide to the Nikon F80/N80

by Matthew Dennis

With its combination of sophisticated, high-tech features and extremely reasonable pricing, the Nikon F80/N80 is a proven winner. This handbook helps users stretch the camera to its limits. Explains every aspect of layout and operation. Learn everything about the basic functions, including focusing and exposure, flash fundamentals, the close-up system, and more. 192 pgs.

Item # STPIPGN80.....19.95

### Historic Photographic Processes

by Richard Farber

A comprehensive user's guide to the historical processes that have become popular alternatives to modern and digital technology. Though many of the techniques, applications, and equipment were first developed in the nineteenth century, these same methods can be used today to create hand-crafted images that are more attractive and permanent. 256 pgs.

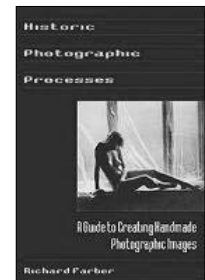

Item # AMHPP.....29.95

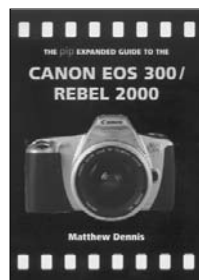

### The PIP Expanded Guide to the Canon EOS 300/Rebel 2000

by Matthew Dennis

The Rebel 2000 is ideal for beginners, and they will particularly benefit from the information and the opportunity to explore the inner workings of every feature. Of course, there's plenty of guidance on Canon's extensive array of lenses and accessories. A reassuring operational guide. 192 pgs.

Item # STPEGCE300.....19.95

### Selecting and Using Classic Cameras

A User's Guide to Evaluating Features, Condition and Usability of Classic Cameras

by Michael Levy

This guide concentrates on cameras made between 1920 and 1965. Older cameras can help a photographer master every aspect of manual photography and can be a valuable tool in every studio. The pros, cons, and problems and history of each style. 224 pgs.

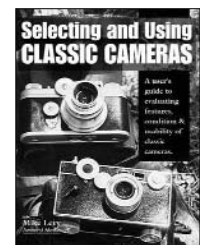

Item # AMSUCC.....29.95

ORDER & INFO. (212) 502-6340 • FAX: (212) 239-7770 (800) 947-7008  
1-800-290-6750 • www.bhphotovideo.com





# INDEX

## SOURCEBOOK INDEX

|  |  |  |  |
|--|--|--|--|
| Achiever: Shoe Mount Flashes.....216                     | Gossen<br>Exposure Meters.....302-307  | Nikonos<br>Underwater Cameras and Acc.....196-199  | SP Studio Systems<br>DC Slave Strobes.....245<br>Exposure Meter.....319                      |
| Acratech: Ballheads.....424                              | Hakuba<br>Tripods.....462<br>Aluminum Cases and Backpacks.....543                          | Noblex<br>Cameras, Lenses & Accessories.....51   | Stratos<br>Flash Brackets.....289  |
| Arca Swiss: Ballheads.....425                            | Hasselblad<br>Cameras, Lenses and Accessories.....48-50                                    | Norman<br>Battery Packs and<br>Portable Strobe Lighting.....267-269  | Sto-Fen<br>Flash Diffuser.....252-253  |
| B+W: Filters.....322-345                                 | Heliopan<br>Filters.....358-363  | Novoflex<br>Flashes and Accessories.....230-233<br>Ballheads and Accessories.....486-492                   | Stroboframe<br>Flash Brackets.....263-265  |
| Beattie: Intenscreens.....8-9                            | Hitech<br>Filters, Holders & Adapter Rings....364-371                                      | Op/Tech<br>Straps and Pouches.....578-582  | Studioball<br>Ballheads.....511  |
| Benbo: Tripods and Ballheads.....426-427                 | Hoya: Filters.....372-387  | Optiflex<br>Filters.....404-405  | Sunpak<br>Flashes and Accessories.....234-241<br>Tripods, Ballheads & Accessories...506-511  |
| Bencher: Copy Stands.....626                             | Ikelite<br>Underwater Housings and Acc.....204-211   | Pelican<br>Cases and Bags.....583-585  | Tamrac<br>Bags and Accessories.....591-607   |
| Berlebach: Ballheads.....428-429                         | Impact<br>AC Radio Slave System.....247<br>Tripods.....463                                 | Pentax<br>Cameras, Lenses and Accessories....138-151   | Tenba<br>Bags and Accessories.....608-616  |
| Beseler: Copy Stands.....627                             | InterFit: Flat Panel Flash.....245   | Phoenix<br>Lenses and Flashes.....152-155  | Testrite<br>Copy Stands and Copy Lights.....634-635  |
| Billingham: Bags and Accessories...526-529               | Kaiser<br>Ballheads.....467<br>Copy Stands.....630-633                                     | Pocket Wizard<br>Slaves and Accessories.....294-297  | Tiffen<br>Filters.....408-419  |
| Body Caps.....643  | Kata: Bags and Accessories.....544-549   | Polaris<br>Exposure Meters.....313   | Tiltall<br>Tripods.....512   |
| Bogen: Copy Stands.....628-629                           | Kenko: Lenses Adapters.....52-53   | Porter Case<br>Cases and Accessories.....586-587   | Tamron<br>Lenses.....172-177   |
| Books.....644-685  | Kodak: Filters.....388-389   | Quantum<br>Battery Packs and<br>Portable Strobe Lighting.....280-289<br>Slaves and Accessories.....290-293 | Tokina<br>Lenses.....178-181   |
| Bracket Plus: Brackets and Accessories...293             | Konica Minolta<br>Cameras, Lenses and Accessories.....76-93<br>Exposure Meters.....308-313 | Remin<br>Folding Carts.....622   | UltraPod<br>Tripods and Accessories.....512  |
| Cable Releases.....642                                   | Leatherman: Tools.....643  | RoadWired<br>Bags and Accessories.....588-590  | Velbon<br>Tripods, Ballheads & Acc.....513-519   |
| Canon<br>Cameras, Lenses and Accessories.....10-47       | Lee: Filters.....390-403   | Rollei<br>Cameras, Lenses and Accessories.....171  | VidPro<br>Bags and Accessories.....617-618   |
| Cleaning Cloths.....637                                  | Leica: Cameras, Lenses & Acc.....54-75   | Rubber Stamp Kits.....673  | Visatec<br>Exposure Meters.....319   |
| Cleaning Tools.....638-639                               | Lens Caps.....675  | Ruuxac<br>Folding Carts.....623  | Vivitar<br>Cameras, Lenses and Accessories....182-185<br>Flashes and Accessories.....242-244 |
| Cleaning Kits & Solutions.....640                        | Lindahl<br>Bellows, Brackets,<br>Vignettes and Filters.....258-261                         | Sealife<br>Underwater Cameras and Accessories...200  | Voigtlander<br>Cameras, Lenses and Accessories....186-193                                    |
| Clipper: Folding Carts.....623                           | Lightware: Bags and Accessories.....550-559  | Sea & Sea<br>Underwater Cameras and Acc.....201-203  | Wein<br>Slaves and Accessories.....298-301<br>Exposure Meters.....319                        |
| Cloud Dome: Portable Lighting Studio...217               | Linhof: Tripods and Ballheads.....464-465  | Sekonic<br>Exposure Meters.....314-318   | Wimberly<br>Ballheads, Brackets & Acc.....520-523  |
| Cokin: Filters.....346-357                               | Lowe Pro: Bags and Accessories.....560-577   | Sigma<br>Cameras, Flashes and Lenses.....156-170   | Writing Pads (all-weather).....673   |
| Crane: Flash Brackets.....256                            | Lumedyne<br>Battery Packs and<br>Portable Strobe Lighting.....270-279                      | Singh-Ray<br>Filters.....406-407   | Zero Halliburton<br>Aluminum Cases.....619   |
| Cullman<br>Tripods, Monopods & Accessories...430-435     | Lumiquest: Light Bouncers.....248-251  | Slik<br>Tripods, Ballheads & Accessories...493-505   | Zing<br>Cases and Pouches.....620-621  |
| Custom Brackets<br>Camera and Flash Brackets.....254-255 | Majestic: Tripods and Gearheads....466-467   | Spectra Cine<br>Exposure Meters.....319  | ZTS<br>Battery Testers.....641   |
| Custom Solutions: Light Bouncers.....251                 | Manfrotto<br>Tripods, Monopods & Ballheads....468-485                                      |  |  |
| Davis & Sanford<br>Tripods and Ballheads.....436-437     | Metz<br>Shoe & Handle Mount Flashes.....218-229  |  |  |
| Delsey: Bags.....530-533                                 | Morris: AC and DC Slave Strobes...246-247  |  |  |
| Domke: Bags and Accessories.....534-538                  | Newton Brackets<br>Camera Brackets and Accessories.....262                                 |  |  |
| Dust Removers.....636-637                                | Nikon<br>Cameras, Lenses and Accessories.....94-137  |  |  |
| Dyna-Lite<br>Portable Strobe Lighting.....266            |  |  |  |
| Ergorest: Tripods.....438                                |  |  |  |
| Exposure Guides.....635                                  |  |  |  |
| Ewa Marine<br>Underwater Housings.....212-213            |  |  |  |
| f.64: Bags and Accessories.....539-542                   |  |  |  |
| FlashFrame: Flash Brackets.....257                       |  |  |  |
| FLM: Ballheads.....439-440                               |  |  |  |
| Giotto<br>Tripods and Ballheads.....442-445              |  |  |  |
| Gitzo<br>Tripods, Monopods & Ballheads....446-461        |  |  |  |

